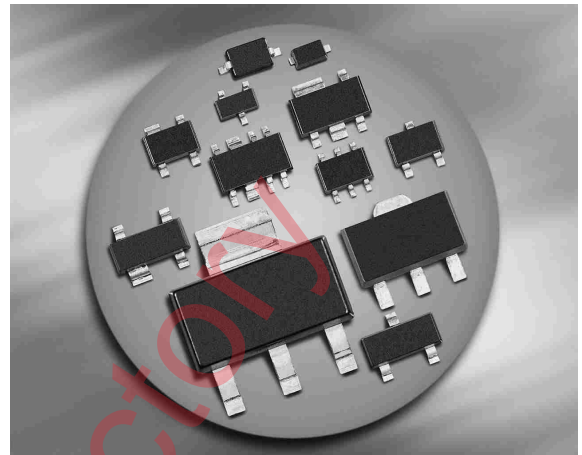
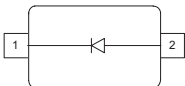
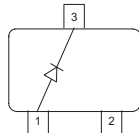
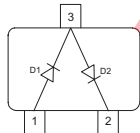
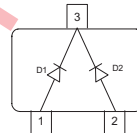
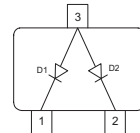
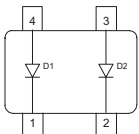

**Silicon Schottky Diode**

- General-purpose diode for high-speed switching
- Circuit protection
- Voltage clamping
- High-level detecting and mixing
- Pb-free (RoHS compliant) package
- Qualified according AEC Q101<sup>1)</sup>

**BAS140W**  
**BAS40-02L**

**BAS40**

**BAS40-04**

**BAS40-05**  
**BAS40-05W**

**BAS40-06**  
**BAS40-06W**

**BAS40-07**  
**BAS40-07W**

**ESD (Electrostatic discharge) sensitive device, observe handling precaution!**

Type	Package	Configuration	Marking
BAS140W	SOD323	single	white 4
BAS40	SOT23	single	43s
BAS40-02L*	TSLP-2-1	single, leadless	FF
BAS40-04	SOT23	series	44s
BAS40-05	SOT23	common cathode	45s
BAS40-05W	SOT323	common cathode	45s
BAS40-06	SOT23	common anode	46s
BAS40-06W	SOT323	common anode	46s
BAS40-07	SOT143	parallel pair	47s
BAS40-07W	SOT343	parallel pair	47s

<sup>1)</sup> BAS40-02L is not qualified according AEC Q101

**Maximum Ratings** at  $T_A = 25\text{ °C}$ , unless otherwise specified

Parameter	Symbol	Value	Unit
Diode reverse voltage	$V_R$	40	V
Forward current	$I_F$	120	mA
Non-repetitive peak surge forward current $t \leq 10\text{ms}$	$I_{FSM}$	200	
Total power dissipation BAS140W, $T_S \leq 113\text{°C}$ BAS40, BAS40-07, $T_S \leq 81\text{°C}$ BAS40-02L, $T_S \leq 127\text{°C}$ BAS40-04, BAS40-06, $T_S \leq 56\text{°C}$ BAS40-06W, $T_S \leq 106\text{°C}$ BAS40-05, $T_S \leq 31\text{°C}$ BAS40-05W, $T_S \leq 98\text{°C}$ BAS40-07W, $T_S \leq 118\text{°C}$	$P_{tot}$	250 250 250 250 250 250 250 250	mW
Junction temperature	$T_j$	150	
Operating temperature range	$T_{op}$	-55 ... 150	
Storage temperature	$T_{stg}$	-55 ... 150	

**Thermal Resistance**

Parameter	Symbol	Value	Unit
Junction - soldering point <sup>1)</sup> BAS140W BAS40, BAS40-07 BAS40-02L BAS40-04, BAS40-06 BAS40-06W BAS40-05 BAS40-05W BAS40-07W	$R_{thJS}$	$\leq 150$ $\leq 275$ $\leq 90$ $\leq 375$ $\leq 175$ $\leq 475$ $\leq 205$ $\leq 125$	K/W

<sup>1)</sup>For calculation of  $R_{thJA}$  please refer to Application Note AN077 (Thermal Resistance Calculation)

**Electrical Characteristics at  $T_A = 25^\circ\text{C}$ , unless otherwise specified**

Parameter	Symbol	Values			Unit
		min.	typ.	max.	
<b>DC Characteristics</b>					
Breakdown voltage $I_{(BR)} = 10 \mu\text{A}$	$V_{(BR)}$	40	-	-	V
Reverse current $V_R = 30 \text{ V}$	$I_R$	-	-	1	$\mu\text{A}$
Forward voltage $I_F = 1 \text{ mA}$ $I_F = 10 \text{ mA}$ $I_F = 40 \text{ mA}$	$V_F$	250 350 600	310 450 720	380 500 1000	mV
Forward voltage matching <sup>1)</sup> $I_F = 10 \text{ mA}$	$\Delta V_F$	-	-	20	
<b>AC Characteristics</b>					
Diode capacitance $V_R = 0, f = 1 \text{ MHz}$	$C_T$	-	3	5	pF
Differential forward resistance $I_F = 10 \text{ mA}, f = 10 \text{ kHz}$	$R_F$	-	10	-	$\Omega$
Charge carrier life time $I_F = 25 \text{ mA}$	$\tau_{rr}$	-	-	100	ps

<sup>1)</sup> $\Delta V_F$  is the difference between lowest and highest  $V_F$  in a multiple diode component.

**Diode capacitance  $C_T = f(V_R)$**

$f = 1\text{MHz}$

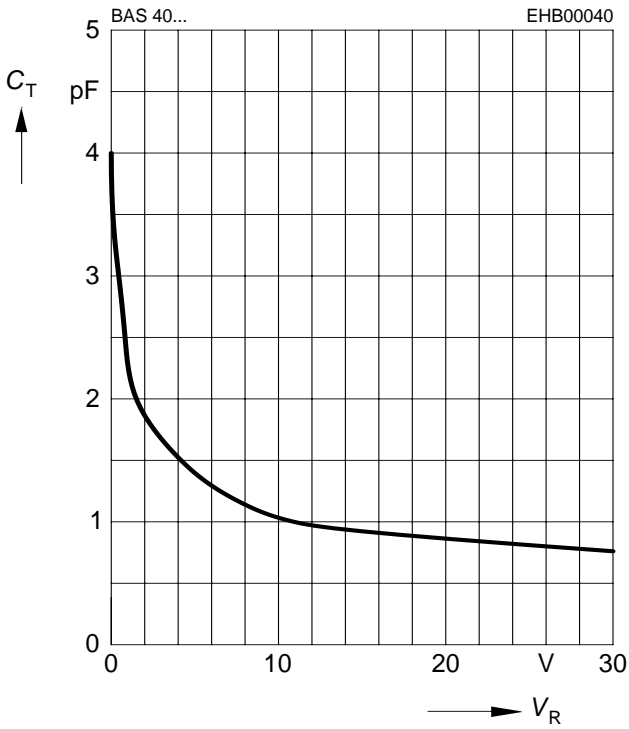

**Forward resistance  $r_f = f(I_F)$**

$f = 10\text{kHz}$

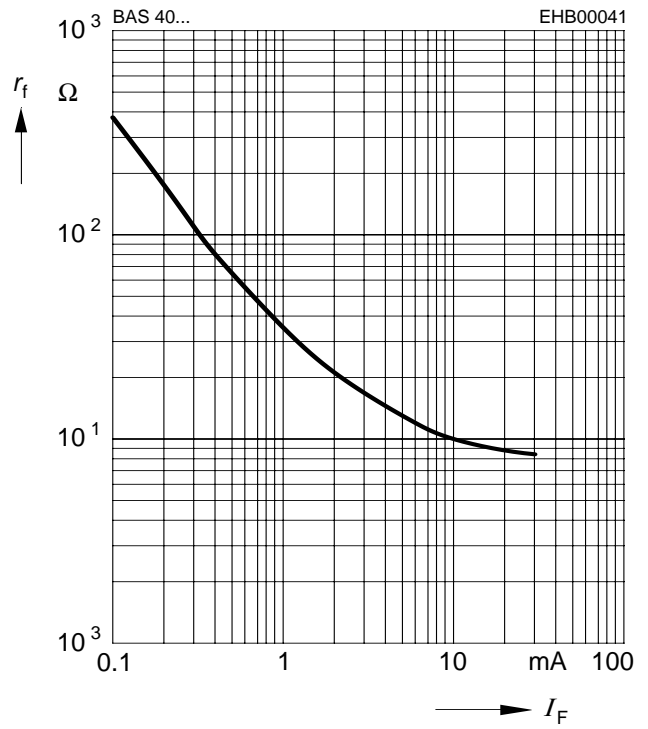

**Reverse current  $I_R = f(T_A)$**

$V_R = \text{Parameter}$

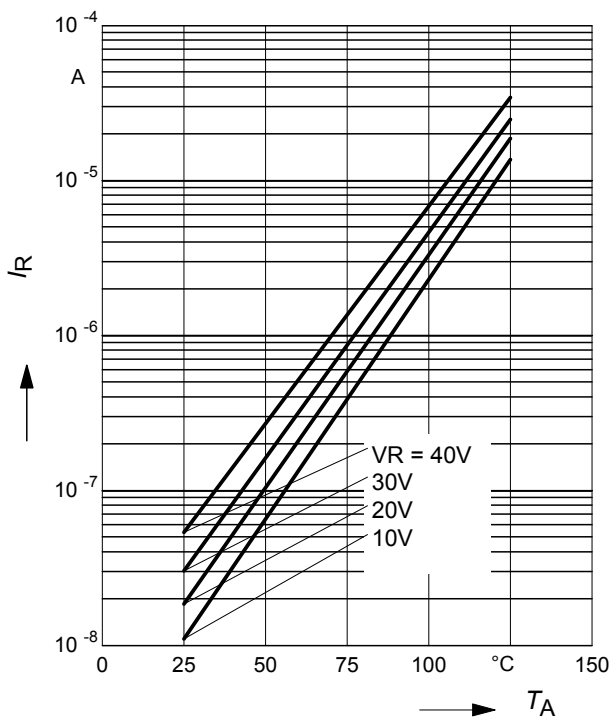

**Reverse current  $I_R = f(V_R)$**

$T_A = \text{Parameter}$

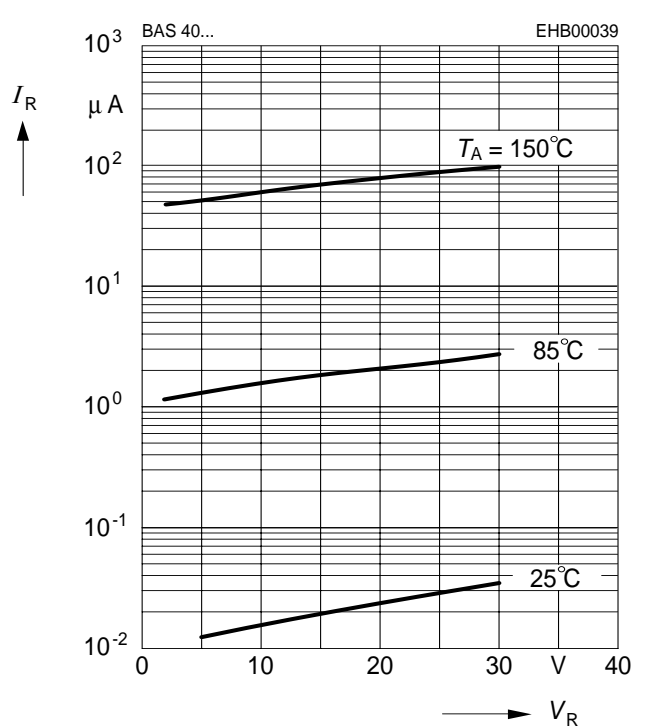

**Forward Voltage  $V_F = f(T_A)$**

$I_F = \text{Parameter}$

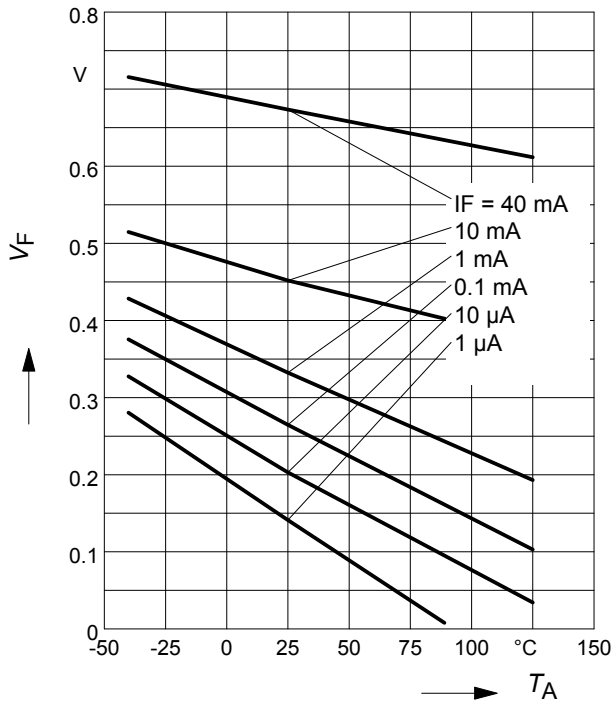

**Forward current  $I_F = f(V_F)$**

$T_A = \text{Parameter}$

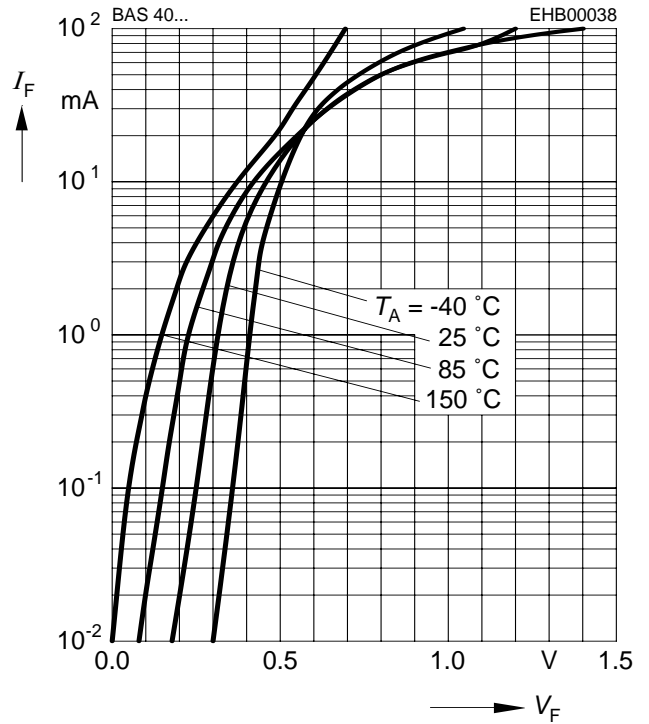

**Forward current  $I_F = f(T_S)$**

BAS140W

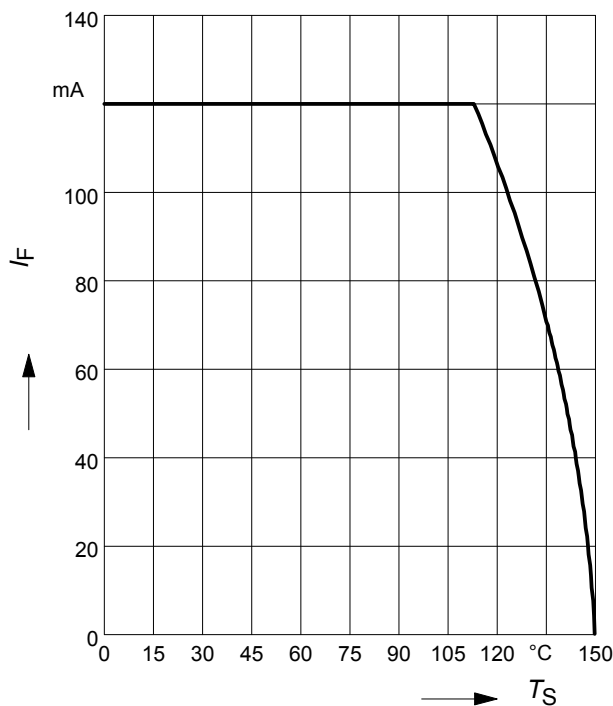

**Forward current  $I_F = f(T_S)$**

BAS40, BAS40-07

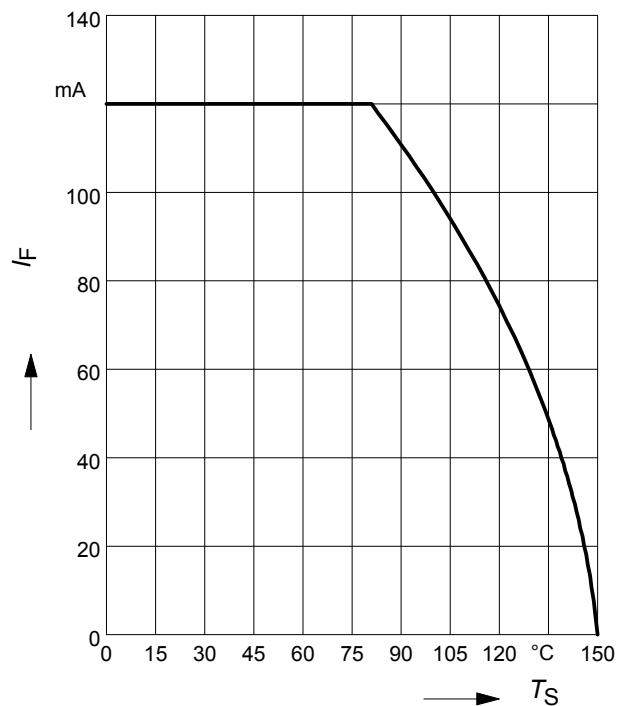

Forward current  $I_F = f(T_S)$

BAS40-02L

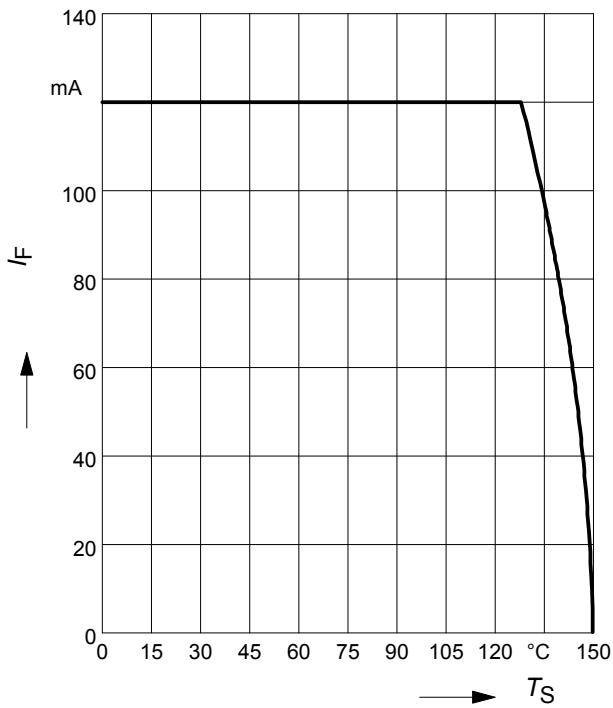

Forward current  $I_F = f(T_S)$

BAS40-04, BAS40-06

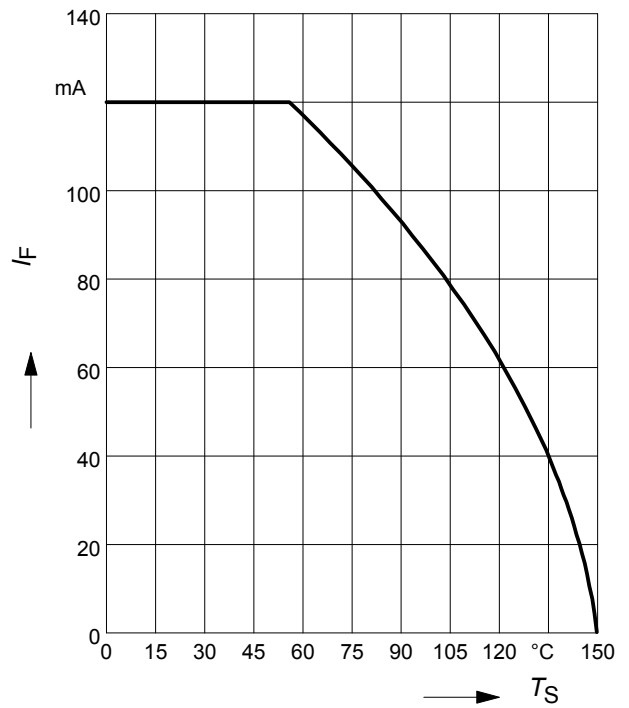

Forward current  $I_F = f(T_S)$

BAS40-06W



Forward current  $I_F = f(T_S)$

BAS40-05

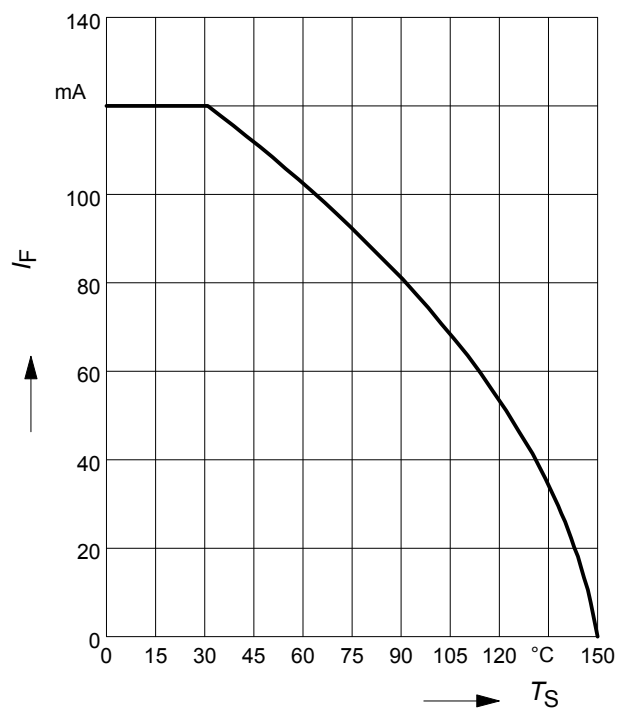

Forward current  $I_F = f(T_S)$

BAS40-05W

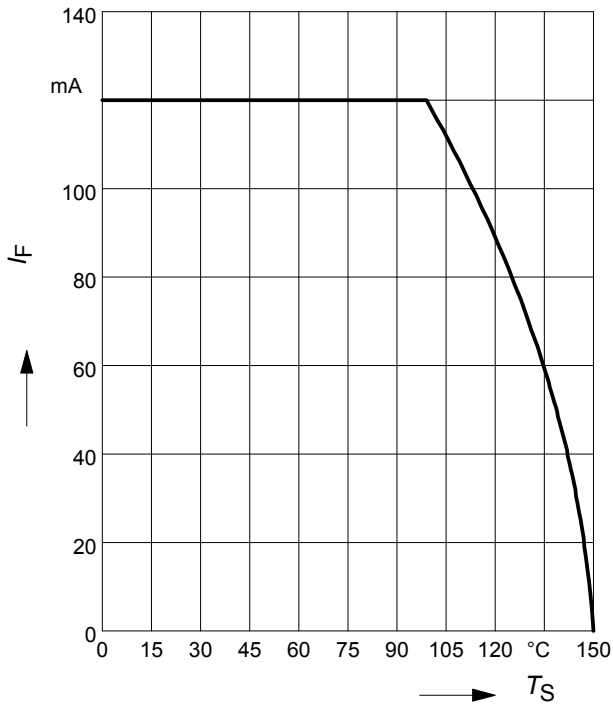

Forward current  $I_F = f(T_S)$

BAS40-07W

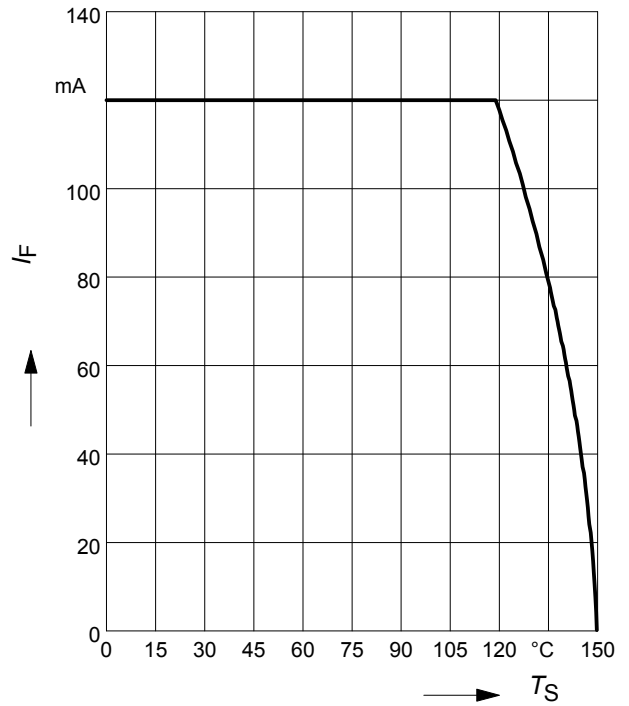

Permissible Puls Load  $R_{thJS} = f(t_p)$

BAS140W

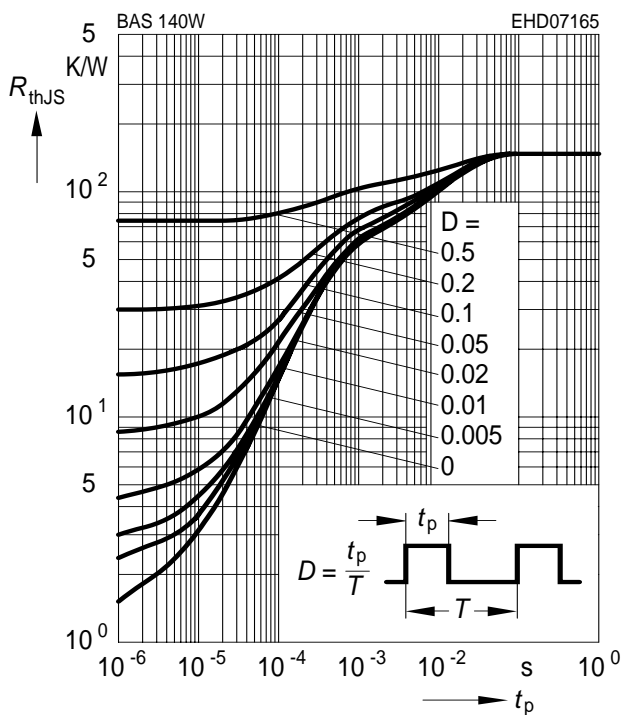

Permissible Pulse Load

$I_{Fmax} / I_{FDC} = f(t_p)$

BAS140W

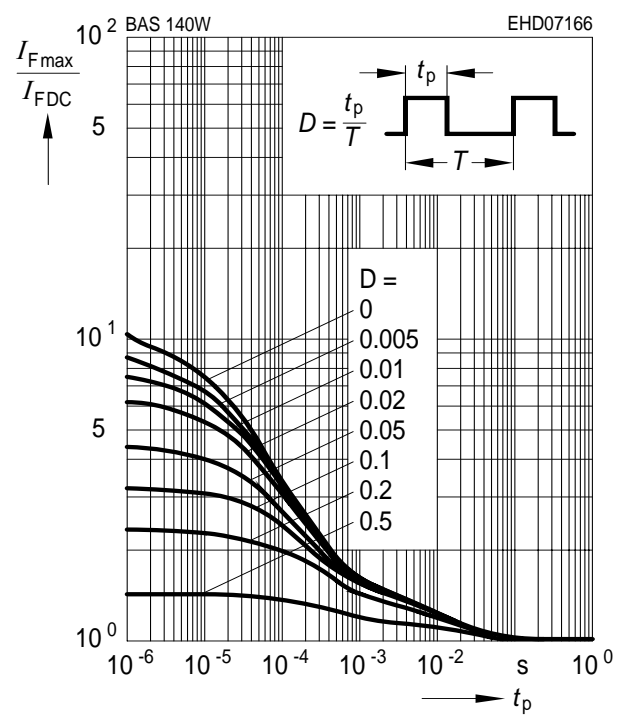

**Permissible Puls Load  $R_{thJS} = f(t_p)$**

BAS40-02L

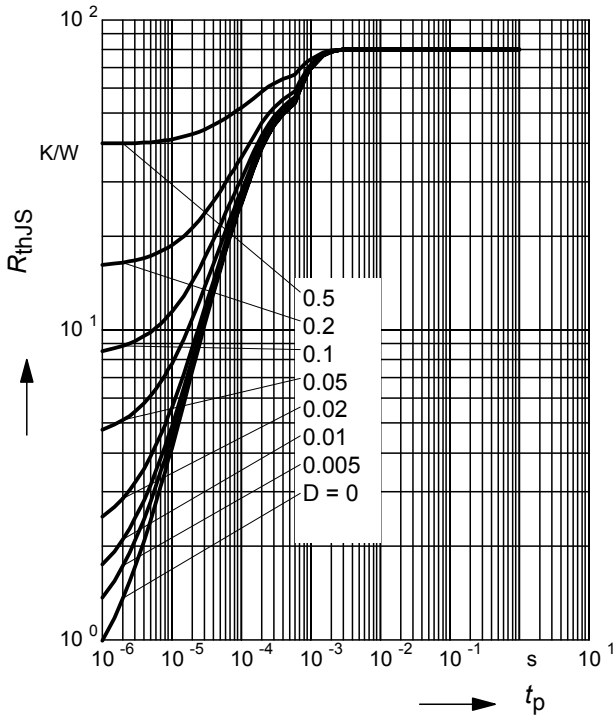

**Permissible Pulse Load**

$I_{Fmax} / I_{FDC} = f(t_p)$

BAS40-02L

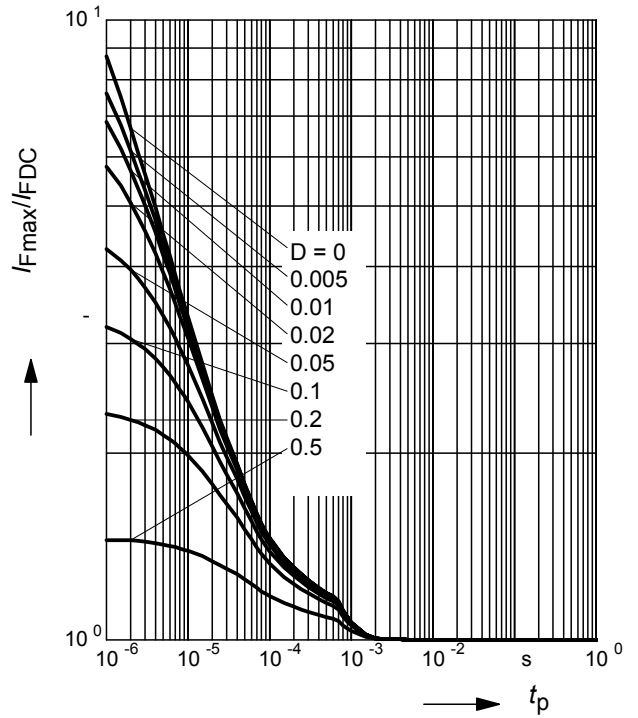

**Permissible Puls Load  $R_{thJS} = f(t_p)$**

BAS40-06W



**Permissible Pulse Load**

$I_{Fmax} / I_{FDC} = f(t_p)$

BAS40-06W

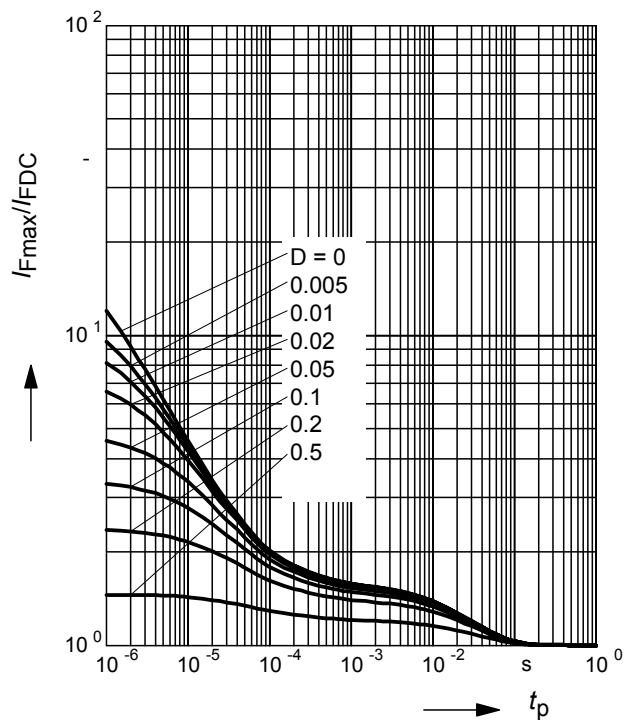



**Permissible Puls Load  $R_{thJS} = f(t_p)$**

BAS40-05W

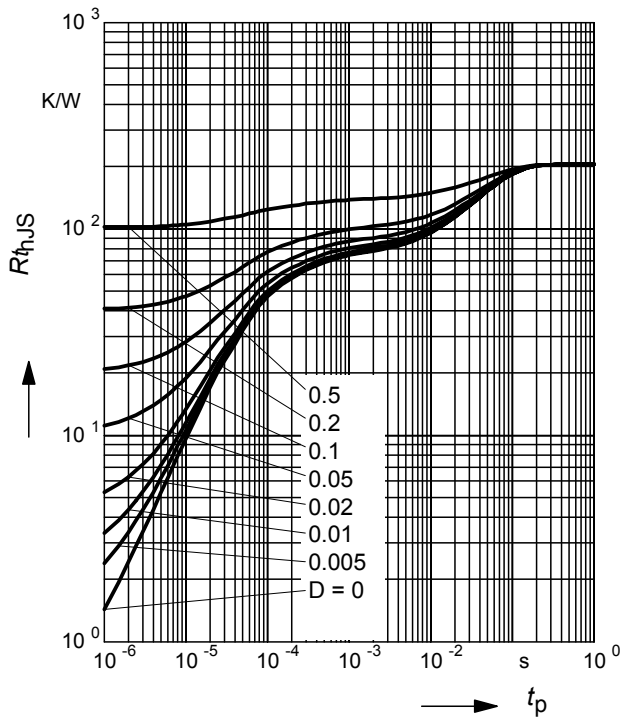

**Permissible Pulse Load**

$I_{Fmax} / I_{FDC} = f(t_p)$

BAS40-05W

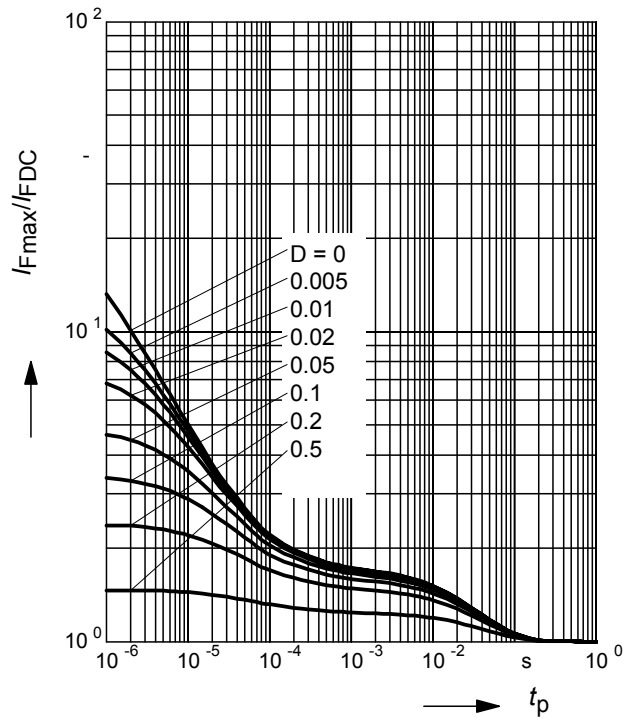

### Package Outline

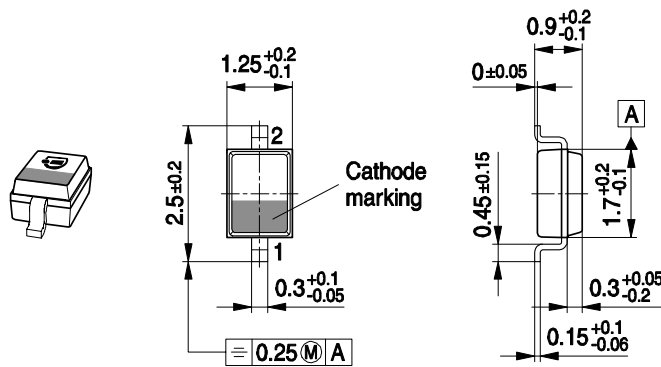

### Foot Print

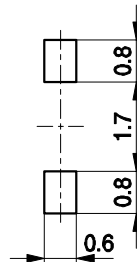

### Marking Layout (Example)

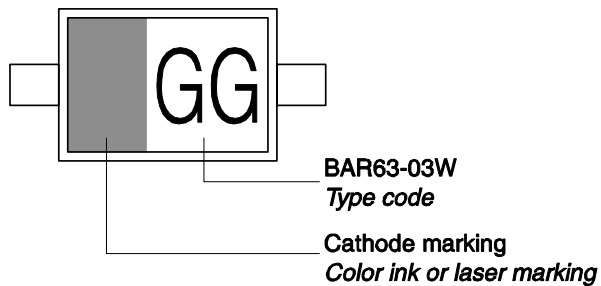

### Standard Packing

Reel  $\varnothing$ 180 mm = 3.000 Pieces/Reel  
 Reel  $\varnothing$ 330 mm = 10.000 Pieces/Reel

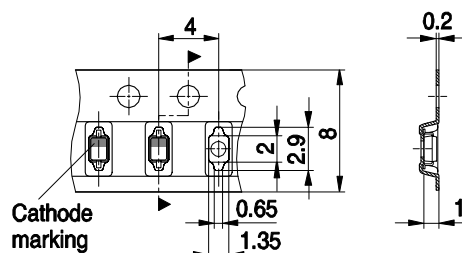

Package Outline

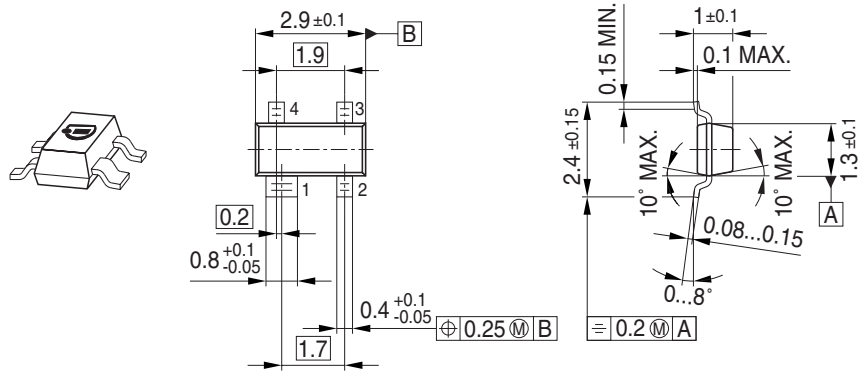

Foot Print

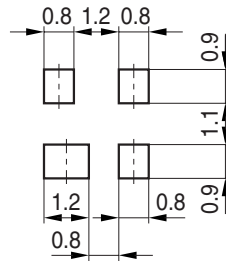

Marking Layout (Example)

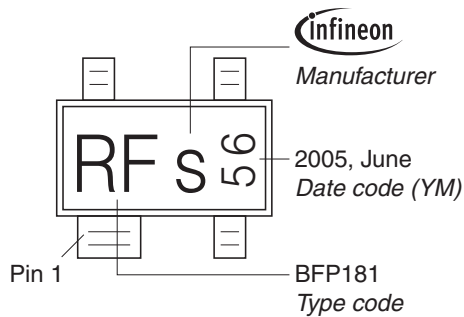

Standard Packing

Reel  $\phi 180$  mm = 3.000 Pieces/Reel  
 Reel  $\phi 330$  mm = 10.000 Pieces/Reel

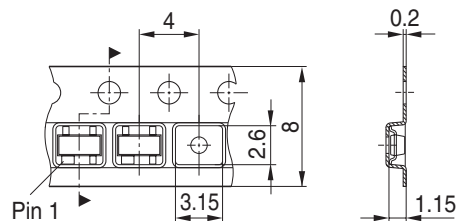

Package Outline

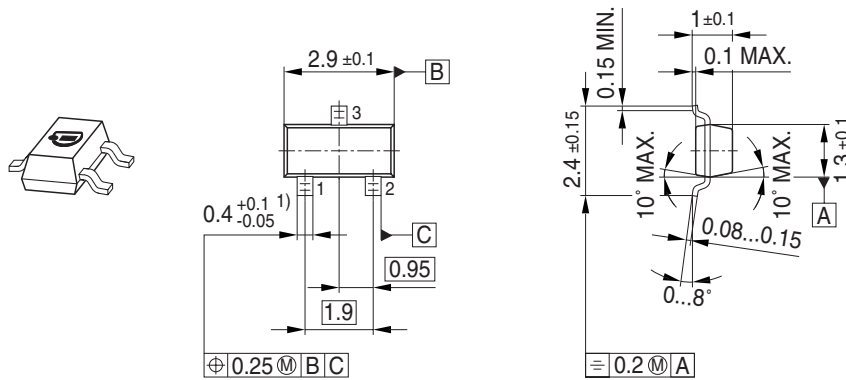

1) Lead width can be 0.6 max. in dambar area

Foot Print

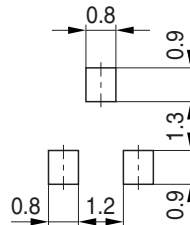

Marking Layout (Example)



Standard Packing

Reel  $\varnothing$ 180 mm = 3.000 Pieces/Reel  
 Reel  $\varnothing$ 330 mm = 10.000 Pieces/Reel



Package Outline



Foot Print



Marking Layout (Example)



Standard Packing

Reel  $\varnothing 180$  mm = 3.000 Pieces/Reel  
 Reel  $\varnothing 330$  mm = 10.000 Pieces/Reel



### Package Outline

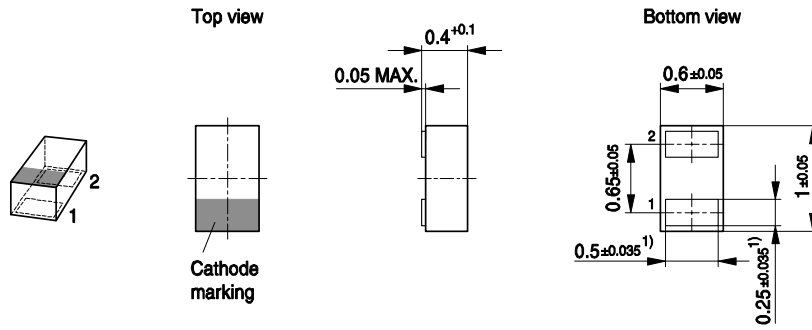

1) Dimension applies to plated terminal

### Foot Print

For board assembly information please refer to Infineon website "Packages"

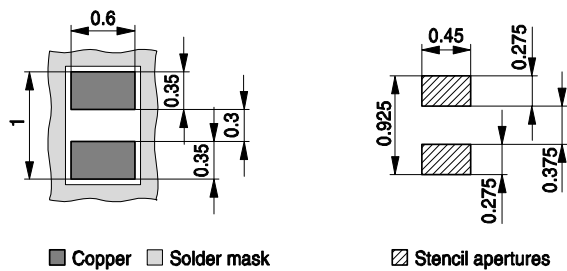

### Marking Layout (Example)

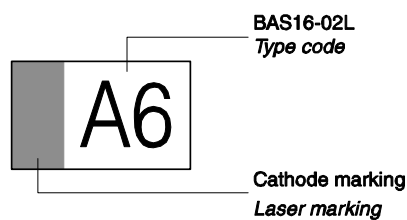

### Standard Packing

Reel  $\varnothing$ 180 mm = 15.000 Pieces/Reel  
 Reel  $\varnothing$ 330 mm = 50.000 Pieces/Reel (optional)

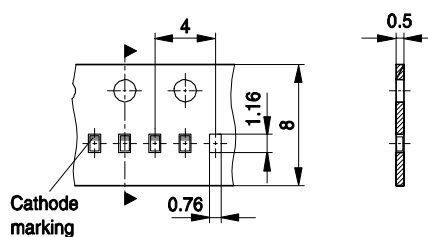

**Edition 2009-11-16**

**Published by  
Infineon Technologies AG  
81726 Munich, Germany**

**© 2009 Infineon Technologies AG  
All Rights Reserved.**

### **Legal Disclaimer**

The information given in this document shall in no event be regarded as a guarantee of conditions or characteristics. With respect to any examples or hints given herein, any typical values stated herein and/or any information regarding the application of the device, Infineon Technologies hereby disclaims any and all warranties and liabilities of any kind, including without limitation, warranties of non-infringement of intellectual property rights of any third party.

### **Information**

For further information on technology, delivery terms and conditions and prices, please contact the nearest Infineon Technologies Office ([<www.infineon.com>](http://www.infineon.com)).

### **Warnings**

Due to technical requirements, components may contain dangerous substances. For information on the types in question, please contact the nearest Infineon Technologies Office.

Infineon Technologies components may be used in life-support devices or systems only with the express written approval of Infineon Technologies, if a failure of such components can reasonably be expected to cause the failure of that life-support device or system or to affect the safety or effectiveness of that device or system. Life support devices or systems are intended to be implanted in the human body or to support and/or maintain and sustain and/or protect human life. If they fail, it is reasonable to assume that the health of the user or other persons may be endangered.