

SAW Bandpass Filter 202195B



1. Features

- IF Bandpass Filter
- High Attenuation
- Single-Ended Operation
- DIP Package
- Maximum Storage Temperature Range : -40°C ~ 85°C
- Electrostatics Sensitive Device (ESD)

2. Package Dimension

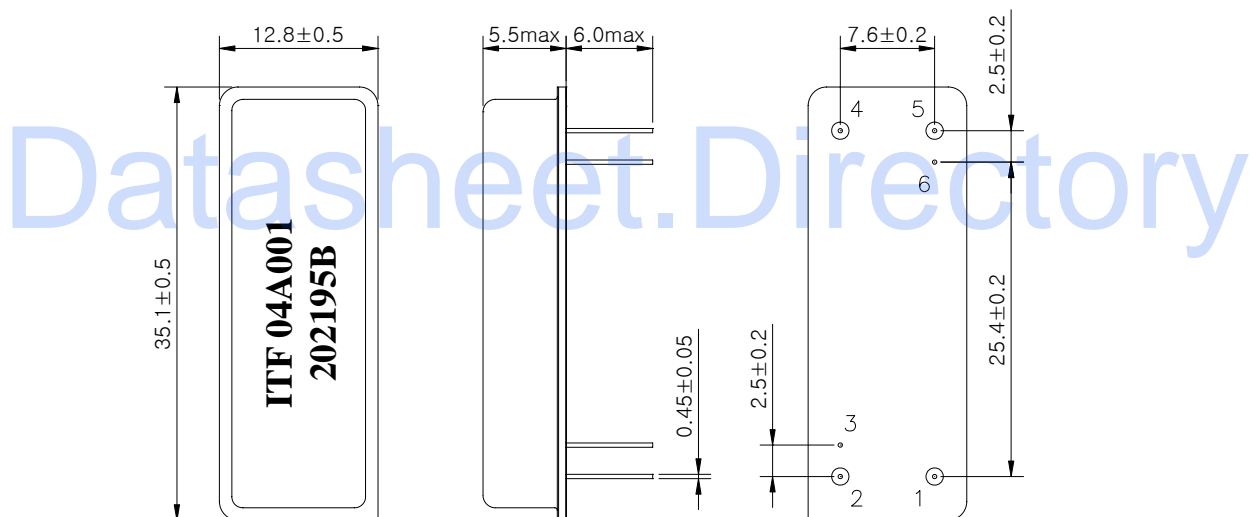

Package : D3512

Dimensions shown are nominal in millimeters
 Base : Fe(SPCC), Au plating over Ni plated
 Cap : Cu & Cr Alloy, Ni Plated
 Termination : Kovar, Au Plated

Pin Configuration	
1	Input
5	Output
2, 4	Ground
Other	Case ground

	ITF Co., Ltd. 102-901, Bucheon Technopark 364, Samjeong-Dong, Ojeong-Gu, Bucheon-City, Gyeonggi-Do, Korea 421-809	Part No.	202195B	
		Rev. Date	2004-04-02	
		Rev.	NW3008-CS02	1/5

SAW Bandpass Filter 202195B



3. Specifications

Fo = 70.0 MHz

Terminating source impedance : 50Ω and matching network

Terminating load impedance : 50Ω and matching network

		Minimum	Typical	Maximum
Center Frequency	MHz	-	70.0	-
Insertion Loss	dB	-	24.0	25.5
1dB Bandwidth	MHz	-	18.9	-
3dB Bandwidth	MHz	18.9	19.1	-
40dB Bandwidth	MHz	-	20.0	20.1
Amplitude Ripple (Fo +/- 9.22 MHz)	dB	-	0.75	1.0
Group Delay Variation (Fo +/- 9.22 MHz)	nsec	-	60	120
Absolute Delay	usec	-	3.1	-
Ultimate Rejection	dB	50	55	-
Temperature Coefficient of Frequency	ppm/°C	-	-72.0	-

Notes :

- 1) All specifications are based on the matching schematic shown below
- 2) All specifications are measured by Agilent Network analyzer and full 2 port calibration at room temperature
- 3) All attenuation measurements are measured relative to insertion loss

 Integrated Technology Future	ITF Co., Ltd. 102-901, Bucheon Technopark 364, Samjeong-Dong, Ojeong-Gu, Bucheon-City, Gyeonggi-Do, Korea 421-809	Part No.	202195B	
		Rev. Date	2004-04-02	
		Rev.	NW3008-CS02	2/5

SAW Bandpass Filter 202195B



4. Matching Schematic

(Actual matching values may vary due to PCB layout and parasitics)

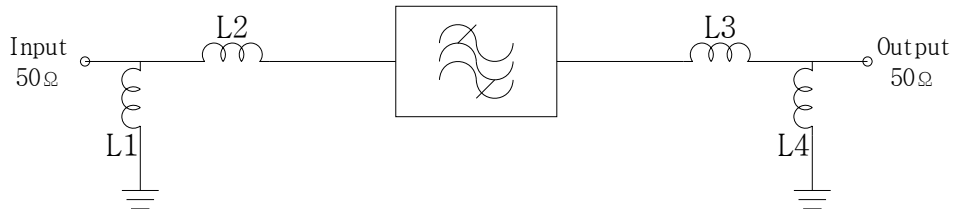

L2 = 47 nH, L3 = 47 nH
 L1 = 220 nH, L4 = 180 nH

5. Marking Configuration

ITF¹⁾ 04A001²⁾
 202195B³⁾

- 1) Manufacturer name
- 2) Lot Number
- 3) Part Number

	ITF Co., Ltd. 102-901, Bucheon Technopark 364, Samjeong-Dong, Ojeong-Gu, Bucheon-City, Gyeonggi-Do, Korea 421-809	Part No.	202195B	
		Rev. Date	2004-04-02	
		Rev.	NW3008-CS02	3/5

SAW Bandpass Filter 202195B



6. Typical Performance (at +25°C)

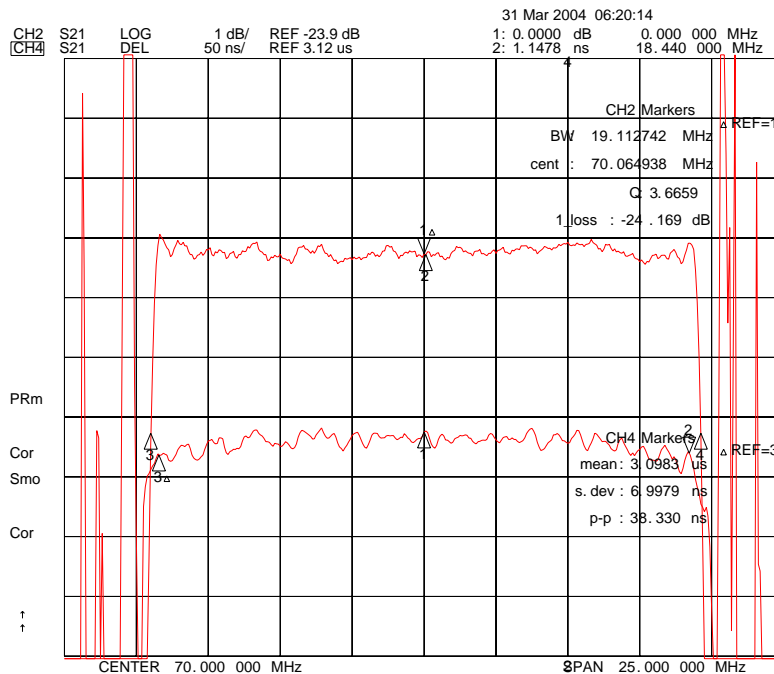
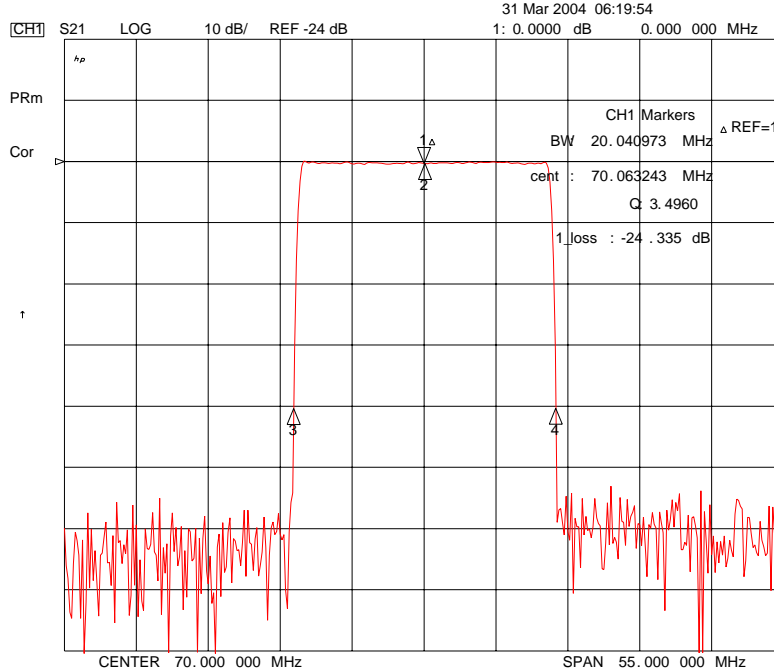

ITF Co., Ltd.
 102-901, Bucheon Technopark 364,
 Samjeong-Dong, Ojeong-Gu, Bucheon-City,
 Gyeonggi-Do, Korea 421-809

Part No.	202195B	
Rev. Date	2004-04-02	
Rev.	NW3008-CS02	4/5

SAW Bandpass Filter 202195B

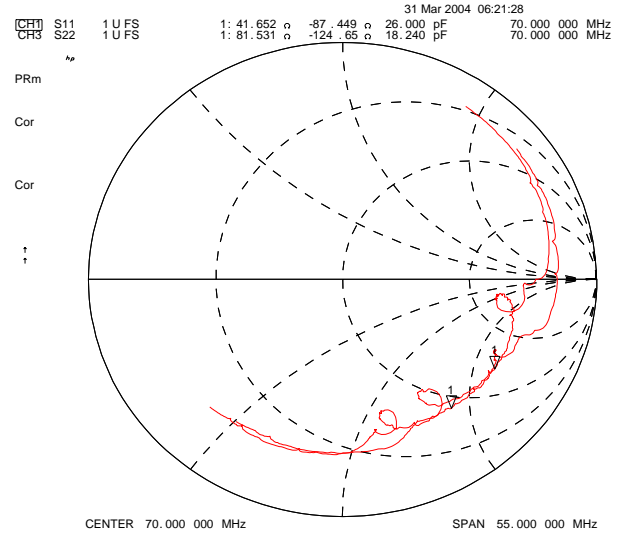
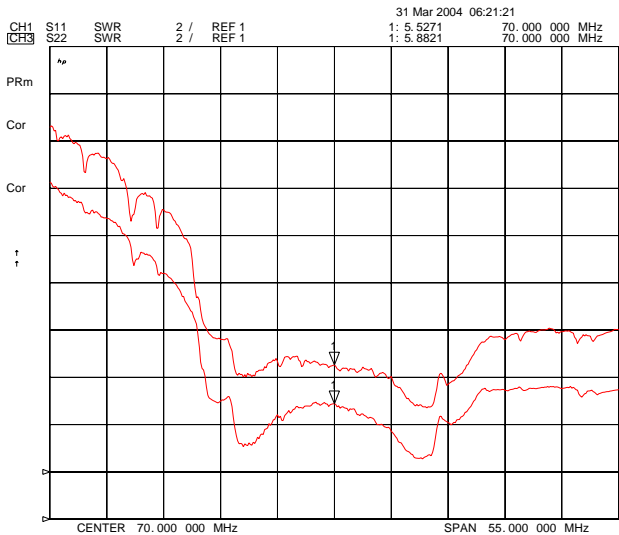
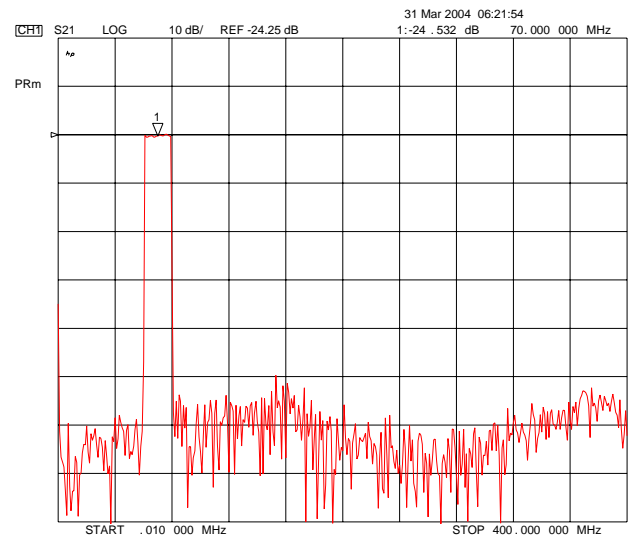
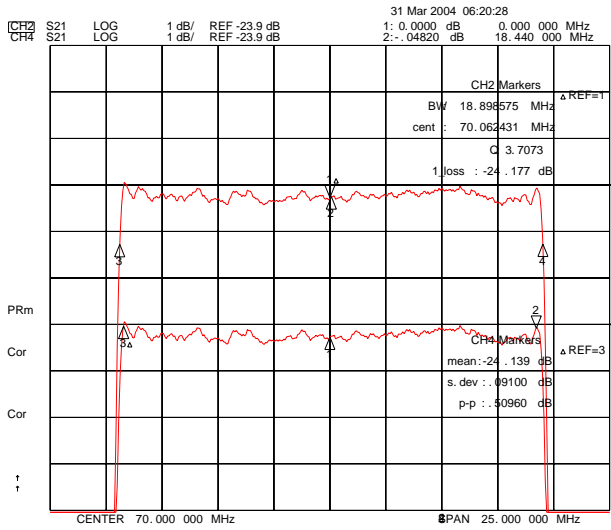

ITF Co., Ltd.
 102-901, Bucheon Technopark 364,
 Samjeong-Dong, Ojeong-Gu, Bucheon-City,
 Gyeonggi-Do, Korea 421-809

Part No.	202195B	
Rev. Date	2004-04-02	
Rev.	NW3008-CS02	5/5