

LM140,A Series
LM340,A Series

THREE-TERMINAL
POSITIVE FIXED
VOLTAGE REGULATORS

SILICON MONOLITHIC
INTEGRATED CIRCUIT

THREE-TERMINAL POSITIVE VOLTAGE REGULATORS

This family of fixed voltage regulators are monolithic integrated circuits capable of driving loads in excess of 1.0 ampere. These three-terminal regulators employ internal current limiting, thermal shutdown, and safe-area compensation. Devices are available with improved specifications, including a 2% output voltage tolerance, on A-suffix 5.0, 12 and 15 volt device types.

Although designed primarily as a fixed voltage regulator, these devices can be used with external components to obtain adjustable voltages and currents. This series of devices can be used with a series-pass transistor to boost output current capability at the nominal output voltage.

- Output Current in Excess of 1.0 Ampere
- No External Components Required
- Output Voltage Offered in 2% and 4% Tolerance*
- Internal Thermal Overload Protection
- Internal Short-Circuit Current Limiting
- Output Transistor Safe-Area Compensation

K SUFFIX
METAL PACKAGE
CASE 1

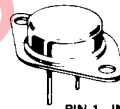

PIN 1. INPUT
 2. OUTPUT
 CASE GROUND

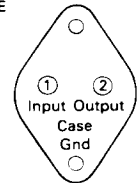

(Bottom View)

T SUFFIX
PLASTIC PACKAGE
CASE 221A

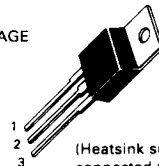

PIN 1. INPUT
 2. GROUND
 3. OUTPUT

(Heatsink surface connected to Pin 2)

ORDERING INFORMATION

Device	Output Voltage and Tolerance	Tested Operating Junction Temp. Range	Package		
LM140K-5.0	5.0 V ± 4%	-55°C to +150°C	Metal Power		
LM140AK-5.0	5.0 V ± 2%				
LM140K-8.0	8.0 V ± 4%				
LM140K-12	12 V ± 4%				
LM140AK-12	12 V ± 2%				
LM140K-15	15 V ± 4%				
LM140AK-15	15 V ± 2%				
LM340K-5.0	5.0 V ± 4%			0°C to +125°C	Metal Power
LM340AK-5.0	5.0 V ± 2%				
LM340T-5.0	5.0 V ± 4%				Plastic Power
LM340AT-5.0	5.0 V ± 2%	Plastic Power			
LM340T-6.0	6.0 V ± 4%	Metal Power			
LM340K-8.0	8.0 V ± 4%	Plastic Power			
LM340T-8.0	8.0 V ± 4%	Metal Power			
LM340K-12	12 V ± 4%	Plastic Power			
LM340AK-12	12 V ± 2%	Metal Power			
LM340T-12	12 V ± 4%	Plastic Power			
LM340AT-12	12 V ± 2%	Metal Power			
LM340K-15	15 V ± 4%				
LM340AK-15	15 V ± 2%	Plastic Power			
LM340T-15	15 V ± 4%				
LM340AT-15	15 V ± 2%				
LM340T-18	18 V ± 4%				
LM340T-24	24 V ± 4%				

STANDARD APPLICATION

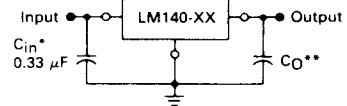

A common ground is required between the input and the output voltages. The input voltage must remain typically 1.7 V above the output voltage even during the low point on the input ripple voltage.

XX = these two digits of the type number indicate voltage.

* = C_{in} is required if regulator is located an appreciable distance from power supply filter.

** = C_{O} is not needed for stability; however, it does improve transient response. If needed, use a 0.1 μF ceramic disc.

*2% regulators are available in 5, 12 and 15 volt devices

LM140,A, LM340,A

MAXIMUM RATINGS (T_A = +25°C unless otherwise noted.)

Rating	Symbol	Value	Unit
Input Voltage (5.0 V - 18 V) (24 V)	V _{in}	35 40	Vdc
Power Dissipation and Thermal Characteristics			
Plastic Package			
T _A = +25°C	P _D	Internally Limited	Watts
Derate above T _A = +25°C	1/θ _{JA}	15.4	mW/°C
Thermal Resistance, Junction to Air	θ _{JA}	65	°C/W
T _C = +25°C	P _D	Internally Limited	Watts
Derate above T _C = +75°C (See Figure 1)	1/θ _{JC}	200	mW/°C
Thermal Resistance, Junction to Case	θ _{JC}	5.0	°C/W
Metal Package			
T _C = +25°C	P _D	Internally Limited	Watts
Derate above T _A = +25°C	1/θ _{JA}	22.5	mW/°C
Thermal Resistance, Junction to Air	θ _{JA}	45	°C/W
T _C = +25°C	P _D	Internally Limited	Watts
Derate above T _C = +65°C (See Figure 2)	1/θ _{JC}	182	mW/°C
Thermal Resistance, Junction to Case	θ _{JC}	5.5	°C/W
Storage Junction Temperature Range	T _{stg}	-65 to +150	°C
Operating Junction Temperature Range	T _J	-55 to -150 0 to -150	°C

3

EQUIVALENT SCHEMATIC DIAGRAM

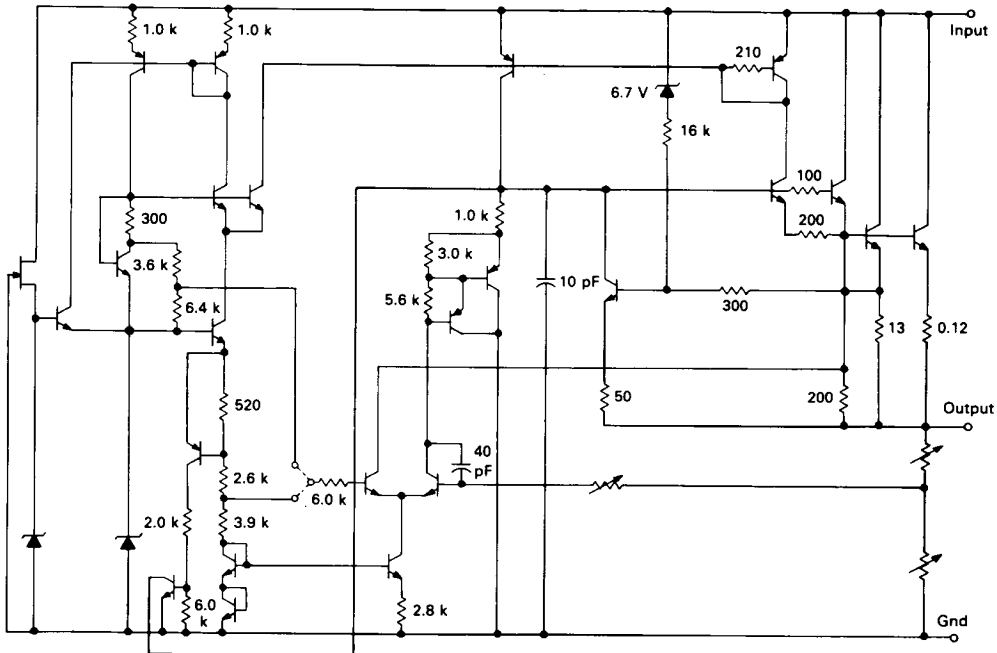

LM140,A, LM340,A

DEFINITIONS

Line Regulation — The change in output voltage for a change in the input voltage. The measurement is made under conditions of low dissipation or by using pulse techniques such that the average chip temperature is not significantly affected.

Load Regulation — The change in output voltage for a change in load current at constant chip temperature.

Maximum Power Dissipation — The maximum total device

dissipation for which the regulator will operate within specifications.

Quiescent Current — That part of the input current that is not delivered to the load.

Output Noise Voltage — The rms ac voltage at the output, with constant load and no input ripple, measured over a specified frequency range.

LM140/340 — 5.0

ELECTRICAL CHARACTERISTICS ($V_{in} = 10\text{ V}$, $I_O = 500\text{ mA}$, $T_J = T_{low}$ to T_{high} (Note 1), unless otherwise noted).

Characteristic	Symbol	Min	Typ	Max	Unit
Output Voltage ($T_J = +25^\circ\text{C}$) $I_O = 5.0\text{ mA}$ to 1.0 A	V_O	4.8	5.0	5.2	Vdc
Line Regulation (Note 2) 8.0 to 20 Vdc 7.0 to 25 Vdc ($T_J = +25^\circ\text{C}$) 8.0 to 12 Vdc, $I_O = 1.0\text{ A}$ 7.3 to 20 Vdc, $I_O = 1.0\text{ A}$ ($T_J = +25^\circ\text{C}$)	Regline	—	—	50	mV
Load Regulation (Note 2) 5.0 mA $\leq I_O \leq 1.0\text{ A}$ 5.0 mA $\leq I_O \leq 1.5\text{ A}$ ($T_J = +25^\circ\text{C}$) 250 mA $\leq I_O \leq 750\text{ mA}$ ($T_J = +25^\circ\text{C}$)	Regload	—	—	50	mV
Output Voltage LM140 8.0 $\leq V_{in} \leq 20\text{ Vdc}$, 5.0 mA $\leq I_O \leq 1.0\text{ A}$, $P_D \leq 15\text{ W}$ LM340 7.0 $\leq V_{in} \leq 20\text{ Vdc}$, 5.0 mA $\leq I_O \leq 1.0\text{ A}$, $P_D \leq 15\text{ W}$	V_O	4.75	—	5.25	Vdc
Quiescent Current $I_O = 1.0\text{ A}$ LM140 LM340 LM140 ($T_J = +25^\circ\text{C}$) LM340 ($T_J = +25^\circ\text{C}$)	I_B	—	—	7.0	mA
Quiescent Current Change 8.0 $\leq V_{in} \leq 25\text{ Vdc}$, $I_O = 500\text{ mA}$ LM140 7.0 $\leq V_{in} \leq 25\text{ Vdc}$, $I_O = 500\text{ mA}$ LM340 5.0 mA $\leq I_O \leq 1.0\text{ A}$, $V_{in} = 10\text{ V}$ LM140, LM340 8.0 $\leq V_{in} \leq 20\text{ Vdc}$, $I_O = 1.0\text{ A}$ LM140 7.5 $\leq V_{in} \leq 20\text{ Vdc}$, $I_O = 1.0\text{ A}$ LM340	ΔI_B	—	—	0.8	mA
Ripple Rejection LM140 LM340 $I_O = 1.0\text{ A}$ ($T_J = +25^\circ\text{C}$) LM140 LM340	RR	68	—	—	dB
Dropout Voltage	$V_{in} - V_O$	—	1.7	—	Vdc
Output Resistance ($f = 1.0\text{ kHz}$)	r_O	—	2.0	—	$m\Omega$
Short-Circuit Current Limit ($T_J = +25^\circ\text{C}$)	I_{sc}	—	2.0	—	mA
Output Noise Voltage ($T_A = +25^\circ\text{C}$) 10 Hz $\leq f \leq 100\text{ kHz}$	V_n	—	40	—	μV
Average Temperature Coefficient of Output Voltage $I_O = 5.0\text{ mA}$	TCV_O	—	± 0.6	—	$mV/^\circ\text{C}$
Peak Output Current ($T_J = +25^\circ\text{C}$)	I_O	—	2.4	—	A
Input Voltage to Maintain Line Regulation ($T_J = +25^\circ\text{C}$) $I_O = 1.0\text{ A}$		7.3	—	—	Vdc

NOTES: 1. $T_{low} = 55^\circ\text{C}$ for LM140 $T_{high} = +150^\circ\text{C}$ for LM140
= 0°C for LM340 = $+125^\circ\text{C}$ for LM340

2. Load and line regulation are specified at constant junction temperature. Changes in V_O due to heating effects must be taken into account separately. Pulse testing with low duty cycle is used.

LM140,A, LM340,A

LM140A/340A — 5.0

ELECTRICAL CHARACTERISTICS ($V_{in} = 10\text{ V}$, $I_O = 1.0\text{ A}$, $T_J = T_{low}$ to T_{high} (Note 1), unless otherwise noted).

Characteristic	Symbol	Min	Typ	Max	Unit
Output Voltage ($T_J = +25^\circ\text{C}$) $I_O = 5.0\text{ mA}$ to 1.0 A	V_O	4.9	5.0	5.1	Vdc
Line Regulation (Note 2) 7.5 to 20 Vdc, $I_O = 500\text{ mA}$ 7.3 to 20 Vdc ($T_J = +25^\circ\text{C}$) 8.0 to 12 Vdc 8.0 to 12 Vdc ($T_J = +25^\circ\text{C}$)	Regline	—	—	10	mV
Load Regulation (Note 2) 5.0 mA $\leq I_O \leq 1.0\text{ A}$ 5.0 mA $\leq I_O \leq 1.5\text{ A}$ ($T_J = +25^\circ\text{C}$) 250 mA $\leq I_O \leq 750\text{ mA}$ ($T_J = +25^\circ\text{C}$)	Regload	—	—	25	mV
Output Voltage 7.5 $\leq V_{in} \leq 20\text{ Vdc}$, 5.0 mA $\leq I_O \leq 1.0\text{ A}$, $P_D \leq 15\text{ W}$	V_O	4.8	—	5.2	Vdc
Quiescent Current ($T_J = +25^\circ\text{C}$)	I_B	—	—	6.5	mA
Quiescent Current Change 5.0 mA $\leq I_O \leq 1.0\text{ A}$, $V_{in} = 10\text{ V}$ 8.0 $\leq V_{in} \leq 25\text{ Vdc}$, $I_O = 500\text{ mA}$ 7.5 $\leq V_{in} \leq 20\text{ Vdc}$, $I_O = 1.0\text{ A}$ ($T_J = +25^\circ\text{C}$)	ΔI_B	—	—	0.5	mA
Ripple Rejection 8.0 $\leq V_{in} \leq 18\text{ Vdc}$, $f = 120\text{ Hz}$ $I_O = 500\text{ mA}$ $I_O = 1.0\text{ A}$ ($T_J = +25^\circ\text{C}$)	RR	68	—	—	dB
Dropout Voltage	$V_{in} - V_O$	—	1.7	—	Vdc
Output Resistance ($f \approx 1.0\text{ kHz}$)	r_O	—	2.0	—	$\text{m}\Omega$
Short-Circuit Current Limit ($T_J = -25^\circ\text{C}$)	I_{sc}	—	2.0	—	mA
Output Noise Voltage ($T_A = +25^\circ\text{C}$) 10 Hz $\leq f \leq 100\text{ kHz}$	V_n	—	40	—	μV
Average Temperature Coefficient of Output Voltage $I_O = 5.0\text{ mA}$	TCV_O	—	± 0.6	—	$\text{mV}/^\circ\text{C}$
Peak Output Current ($T_J = +25^\circ\text{C}$)	I_O	—	2.4	—	A
Input Voltage to Maintain Line Regulation ($T_J = -25^\circ\text{C}$)		7.3	—	—	Vdc

NOTES:

- $T_{low} = -55^\circ\text{C}$ for LM140A $T_{high} = +150^\circ\text{C}$ for LM140A
 $\quad = 0^\circ\text{C}$ for LM340A $\quad = +125^\circ\text{C}$ for LM340A
- Load and line regulation are specified at constant junction temperature. Changes in V_O due to heating effects must be taken into account separately. Pulse testing with low duty cycle is used.

3

LM140,A, LM340,A

LM140/340 — 6.0

ELECTRICAL CHARACTERISTICS ($V_{in} = 11\text{ V}$, $I_O = 500\text{ mA}$, $T_J = T_{low}$ to T_{high} (Note 1), unless otherwise noted).

Characteristic	Symbol	Min	Typ	Max	Unit
Output Voltage ($T_J = +25^\circ\text{C}$) $I_O = 5.0\text{ mA}$ to 1.0 A	V_O	5.75	6.0	6.25	Vdc
Line Regulation (Note 2) 9.0 to 21 Vdc 8.0 to 25 Vdc ($T_J = +25^\circ\text{C}$) 9.0 to 13 Vdc, $I_O = 1.0\text{ A}$ 8.3 to 21 Vdc, $I_O = 1.0\text{ A}$ ($T_J = +25^\circ\text{C}$)	Regline	—	—	60	mV
Load Regulation (Note 2) 5.0 mA $\leq I_O \leq 1.0\text{ A}$ 5.0 mA $\leq I_O \leq 1.5\text{ A}$ ($T_J = +25^\circ\text{C}$) 250 mA $\leq I_O \leq 750\text{ mA}$ ($T_J = +25^\circ\text{C}$)	Regload	—	—	60	mV
Output Voltage LM140 9.0 $\leq V_{in} \leq 21\text{ Vdc}$, 5.0 mA $\leq I_O \leq 1.0\text{ A}$, $P_D \leq 15\text{ W}$ LM340 8.0 $\leq V_{in} \leq 21\text{ Vdc}$, 6.0 mA $\leq I_O \leq 1.0\text{ A}$, $P_D \leq 15\text{ W}$	V_O	5.7	—	6.3	Vdc
Quiescent Current $I_O = 1.0\text{ A}$ LM140 LM340 LM140 ($T_J = +25^\circ\text{C}$) LM340 ($T_J = +25^\circ\text{C}$)	I_B	—	—	7.0	mA
Quiescent Current Change 9.0 $\leq V_{in} \leq 25\text{ Vdc}$, $I_O = 500\text{ mA}$ LM140 8.0 $\leq V_{in} \leq 25\text{ Vdc}$, $I_O = 500\text{ mA}$ LM340 5.0 mA $\leq I_O \leq 1.0\text{ A}$, $V_{in} = 11\text{ V}$ LM140, LM340 9.0 $\leq V_{in} \leq 21\text{ Vdc}$, $I_O = 1.0\text{ A}$ LM140 8.6 $\leq V_{in} \leq 21\text{ Vdc}$, $I_O = 1.0\text{ A}$ LM340	ΔI_B	—	—	0.8	mA
Ripple Rejection LM140 LM340 $I_O = 1.0\text{ A}$ ($T_J = +25^\circ\text{C}$) LM140 LM340	RR	65 59	— —	— —	dB
Dropout Voltage	$V_{in} - V_O$	—	1.7	—	Vdc
Output Resistance ($f = 1.0\text{ kHz}$)	r_O	—	2.0	—	m Ω
Short-Circuit Current Limit ($T_J = +25^\circ\text{C}$)	I_{sc}	—	1.9	—	mA
Output Noise Voltage ($T_A = +25^\circ\text{C}$) 10 Hz $\leq f \leq 100\text{ kHz}$	V_n	—	45	—	μV
Average Temperature Coefficient of Output Voltage $I_O = 5.0\text{ mA}$	TCV_O	—	± 0.7	—	mV/°C
Peak Output Current ($T_J = +25^\circ\text{C}$)	I_O	—	2.4	—	A
Input Voltage to Maintain Line Regulation ($T_J = -25^\circ\text{C}$) $I_O = 1.0\text{ A}$		8.3	—	—	Vdc

NOTES:

1. $T_{low} = -55^\circ\text{C}$ for LM140 $T_{high} = -150^\circ\text{C}$ for LM140
 = 0°C for LM340 = $+125^\circ\text{C}$ for LM340

2. Load and line regulation are specified at constant junction temperature. Changes in V_O due to heating effects must be taken into account separately. Pulse testing with low duty cycle is used.

LM140,A, LM340,A

LM140A/340A — 12

ELECTRICAL CHARACTERISTICS ($V_{in} = 19\text{ V}$, $I_O = 1.0\text{ A}$, $T_J = T_{low}$ to T_{high} (Note 1), unless otherwise noted).

Characteristic	Symbol	Min	Typ	Max	Unit
Output Voltage ($T_J = +25^\circ\text{C}$) $I_O = 5.0\text{ mA}$ to 1.0 A	V_O	11.75	12	12.25	Vdc
Line Regulation (Note 2) 14.8 to 27 Vdc, $I_O = 500\text{ mA}$ 14.5 to 27 Vdc ($T_J = -25^\circ\text{C}$) 16 to 22 Vdc 16 to 22 Vdc ($T_J = +25^\circ\text{C}$)	Reg _{line}	—	—	18 18 30 9.0	mV
Load Regulation (Note 2) $5.0\text{ mA} \leq I_O \leq 1.0\text{ A}$ $5.0\text{ mA} \leq I_O \leq 1.5\text{ A}$ ($T_J = +25^\circ\text{C}$) $250\text{ mA} \leq I_O \leq 750\text{ mA}$ ($T_J = +25^\circ\text{C}$)	Reg _{load}	—	—	60 32 19	mV
Output Voltage $14.8 \leq V_{in} \leq 27\text{ Vdc}$, $5.0\text{ mA} \leq I_O \leq 1.0\text{ A}$, $P_D \leq 15\text{ W}$	V_O	11.5	—	12.5	Vdc
Quiescent Current ($T_J = +25^\circ\text{C}$)	I_B	—	—	6.5 6.0	mA
Quiescent Current Change $5.0\text{ mA} \leq I_O \leq 1.0\text{ A}$, $V_{in} = 19\text{ V}$ $15 \leq V_{in} \leq 30\text{ Vdc}$, $I_O = 500\text{ mA}$ $14.8 \leq V_{in} \leq 27\text{ Vdc}$, $I_O = 1.0\text{ A}$ ($T_J = +25^\circ\text{C}$)	ΔI_B	—	—	0.5 0.8 0.8	mA
Ripple Rejection $15 \leq V_{in} \leq 25\text{ Vdc}$, $f = 120\text{ Hz}$ $I_O = 500\text{ mA}$ $I_O = 1.0\text{ A}$, ($T_J = +25^\circ\text{C}$)	RR	61 61	— 72	— —	dB
Dropout Voltage	$V_{in} - V_O$	—	1.7	—	Vdc
Output Resistance ($f = 1.0\text{ kHz}$)	r_O	—	2.0	—	m Ω
Short-Circuit Current Limit ($T_J = +25^\circ\text{C}$)	I_{sc}	—	1.1	—	mA
Output Noise Voltage ($T_A = +25^\circ\text{C}$) $10\text{ Hz} \leq f \leq 100\text{ kHz}$	V_n	—	75	—	μV
Average Temperature Coefficient of Output Voltage $I_O = 5.0\text{ mA}$	TCV_O	—	± 1.5	—	mV/°C
Peak Output Current ($T_J = +25^\circ\text{C}$)	I_O	—	2.4	—	A
Input Voltage to Maintain Line Regulation ($T_J = -25^\circ\text{C}$)		14.5	—	—	Vdc

NOTES:

- $T_{low} = -55^\circ\text{C}$ for LM140A $T_{high} = +150^\circ\text{C}$ for LM140A
 $\quad = 0^\circ\text{C}$ for LM340A $\quad = +125^\circ\text{C}$ for LM340A
- Load and line regulation are specified at constant junction temperature. Changes in V_O due to heating effects must be taken into account separately. Pulse testing with low duty cycle is used.



LM140,A, LM340,A

LM140A/340A — 15

ELECTRICAL CHARACTERISTICS ($V_{in} = 23\text{ V}$, $I_O = 1.0\text{ A}$, $T_J = T_{low}$ to T_{high} (Note 1), unless otherwise noted).

3

Characteristic	Symbol	Min	Typ	Max	Unit
Output Voltage ($T_J = +25^\circ\text{C}$) $I_O = 5.0\text{ mA}$ to 1.0 A	V_O	14.7	15	15.3	Vdc
Line Regulation (Note 2) 17.9 to 30 Vdc, $I_O = 500\text{ mA}$ 17.5 to 30 Vdc ($T_J = -25^\circ\text{C}$) 20 to 26 Vdc, $I_O = 1.0\text{ A}$ 20 to 26 Vdc, $I_O = 1.0\text{ A}$ ($T_J = +25^\circ\text{C}$)	Reg _{line}	—	—	22	mV
Load Regulation (Note 2) $5.0\text{ mA} \leq I_O \leq 1.0\text{ A}$ $5.0\text{ mA} \leq I_O \leq 1.5\text{ A}$ ($T_J = +25^\circ\text{C}$) $250\text{ mA} \leq I_O \leq 750\text{ mA}$ ($T_J = +25^\circ\text{C}$)	Reg _{load}	—	—	75	mV
Output Voltage $17.9 \leq V_{in} \leq 30\text{ Vdc}$, $5.0\text{ mA} \leq I_O \leq 1.0\text{ A}$, $P_D \leq 15\text{ W}$	V_O	14.4	—	15.6	Vdc
Quiescent Current ($T_J = +25^\circ\text{C}$)	I_B	—	—	6.5	mA
Quiescent Current Change $5.0\text{ mA} \leq I_O \leq 1.0\text{ A}$, $V_{in} = 23\text{ V}$ $17.9 \leq V_{in} \leq 30\text{ Vdc}$, $I_O = 500\text{ mA}$ $17.9 \leq V_{in} \leq 30\text{ Vdc}$, $I_O = 1.0\text{ A}$ ($T_J = +25^\circ\text{C}$)	ΔI_B	—	—	0.5	mA
Ripple Rejection $18.5 \leq V_{in} \leq 28.5\text{ Vdc}$, $f = 120\text{ Hz}$ $I_O = 500\text{ mA}$ $I_O = 1.0\text{ A}$, ($T_J = +25^\circ\text{C}$)	RR	60	—	—	dB
Dropout Voltage	$V_{in} - V_O$	—	1.7	—	Vdc
Output Resistance ($f = 1.0\text{ kHz}$)	r_O	—	2.0	—	m Ω
Short-Circuit Current Limit ($T_J = +25^\circ\text{C}$)	I_{sc}	—	800	—	mA
Output Noise Voltage ($T_A = +25^\circ\text{C}$) $10\text{ Hz} \leq f \leq 100\text{ kHz}$	V_n	—	90	—	μV
Average Temperature Coefficient of Output Voltage $I_O = 5.0\text{ mA}$	TCV_O	—	± 1.8	—	mV/°C
Peak Output Current ($T_J = +25^\circ\text{C}$)	I_O	—	2.4	—	A
Input Voltage to Maintain Line Regulation ($T_J = +25^\circ\text{C}$)		17.5	—	—	Vdc

NOTES:

- $T_{low} = -55^\circ\text{C}$ for LM140A $T_{high} = +150^\circ\text{C}$ for LM140A
 $\phantom{T_{low}} = 0^\circ\text{C}$ for LM340A $\phantom{T_{low}} = +125^\circ\text{C}$ for LM340A
- Load and line regulation are specified at constant junction temperature. Changes in V_O due to heating effects must be taken into account separately. Pulse testing with low duty cycle is used.

LM140,A, LM340,A

LM140/340 — 24

ELECTRICAL CHARACTERISTICS ($V_{in} = 33\text{ V}$, $I_O = 500\text{ mA}$, $T_J = T_{low}$ to T_{high} (Note 1), unless otherwise noted).

Characteristic	Symbol	Min	Typ	Max	Unit
Output Voltage ($T_J = +25^\circ\text{C}$) $I_O = 5.0\text{ mA}$ to 1.0 A	V_O	23	24	25	Vdc
Line Regulation (Note 2) 28 to 38 Vdc 27 to 38 Vdc ($T_J = +25^\circ\text{C}$) 30 to 36 Vdc, $I_O = 1.0\text{ A}$ 27.1 to 38 Vdc, $I_O = 1.0\text{ A}$ ($T_J = +25^\circ\text{C}$)	Reg _{line}	—	—	240	mV
Load Regulation (Note 2) $5.0\text{ mA} \leq I_O \leq 1.0\text{ A}$ $5.0\text{ mA} \leq I_O \leq 1.5\text{ A}$ ($T_J = +25^\circ\text{C}$) $250\text{ mA} \leq I_O \leq 750\text{ mA}$ ($T_J = -25^\circ\text{C}$)	Reg _{load}	—	—	240	mV
Output Voltage LM140 $28 \leq V_{in} \leq 38\text{ Vdc}$, $5.0\text{ mA} \leq I_O \leq 1.0\text{ A}$, $P_D \leq 15\text{ W}$ LM340 $27 \leq V_{in} \leq 38\text{ Vdc}$, $5.0\text{ mA} \leq I_O \leq 1.0\text{ A}$, $P_D \leq 15\text{ W}$	V_O	22.8	—	25.2	Vdc
Quiescent Current $I_O = 1.0\text{ A}$ LM140 LM340 LM140 ($T_J = +25^\circ\text{C}$) LM340 ($T_J = +25^\circ\text{C}$)	I_B	—	—	7.0	mA
Quiescent Current Change $28 \leq V_{in} \leq 38\text{ Vdc}$, $I_O = 500\text{ mA}$ LM140 $27 \leq V_{in} \leq 38\text{ Vdc}$, $I_O = 500\text{ mA}$ LM340 $5.0\text{ mA} \leq I_O \leq 1.0\text{ A}$, $V_{in} = 33\text{ V}$ LM140, LM340 $28 \leq V_{in} \leq 38\text{ Vdc}$, $I_O = 1.0\text{ A}$ LM140 $27.3 \leq V_{in} \leq 38\text{ Vdc}$, $I_O = 1.0\text{ A}$ LM340	ΔI_B	—	—	0.8	mA
Ripple Rejection LM140 LM340 $I_O = 1.0\text{ A}$ ($T_J = +25^\circ\text{C}$) LM140 LM340	RR	56	—	—	dB
Dropout Voltage	$V_{in} - V_O$	—	1.7	—	Vdc
Output Resistance ($f = 1.0\text{ kHz}$)	r_O	—	2.0	—	m Ω
Short-Circuit Current Limit ($T_J = -25^\circ\text{C}$)	I_{sc}	—	200	—	mA
Output Noise Voltage ($T_A = +25^\circ\text{C}$) $10\text{ Hz} \leq f \leq 100\text{ kHz}$	V_n	—	170	—	μV
Average Temperature Coefficient of Output Voltage $I_O = 5.0\text{ mA}$	TCV _O	—	± 3.0	—	mV/°C
Peak Output Current ($T_J = +25^\circ\text{C}$)	I_O	—	2.4	—	A
Input Voltage to Maintain Line Regulation ($T_J = -25^\circ\text{C}$) $I_O = 1.0\text{ A}$		27.1	—	—	Vdc

NOTES:

- $T_{low} = -55^\circ\text{C}$ for LM140 $T_{high} = +150^\circ\text{C}$ for LM140
 $\phantom{T_{low}} = 0^\circ\text{C}$ for LM340 $\phantom{T_{high}} = +125^\circ\text{C}$ for LM340
- Load and line regulation are specified at constant junction temperature. Changes in V_O due to heating effects must be taken into account separately. Pulse testing with low duty cycle is used.

3

FIGURE 5 — RIPPLE REJECTION versus FREQUENCY

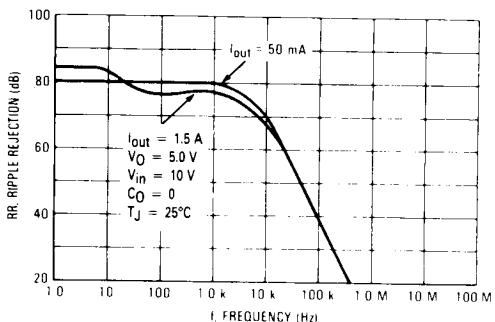

FIGURE 6 — RIPPLE REJECTION versus OUTPUT CURRENT

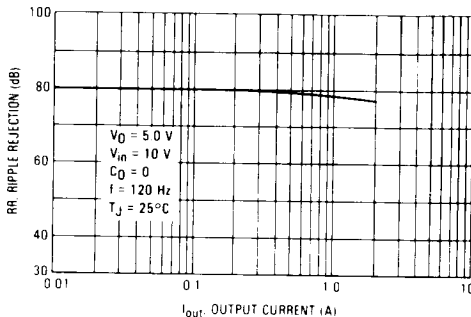

FIGURE 7 — QUIESCENT CURRENT versus INPUT VOLTAGE

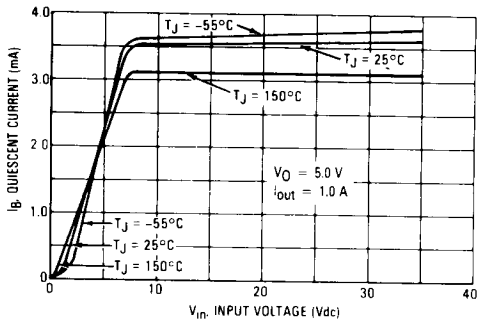

FIGURE 8 — QUIESCENT CURRENT versus OUTPUT CURRENT

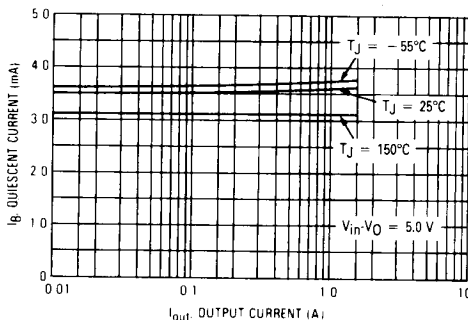

FIGURE 9 — DROPOUT VOLTAGE

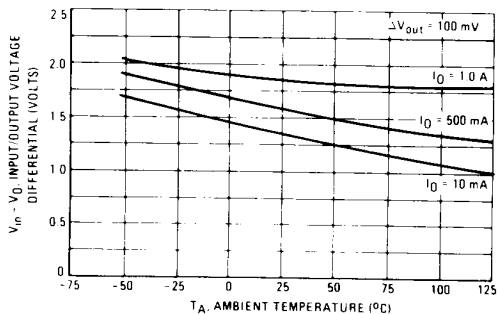
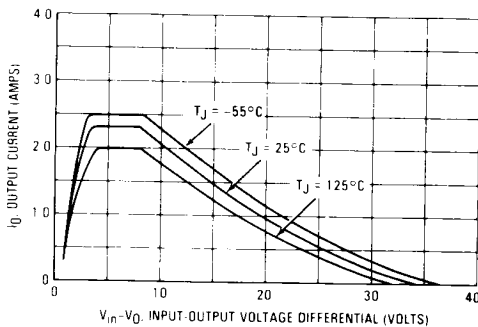

FIGURE 10 — PEAK OUTPUT CURRENT



LM140,A, LM340,A

FIGURE 11 — LINE TRANSIENT RESPONSE

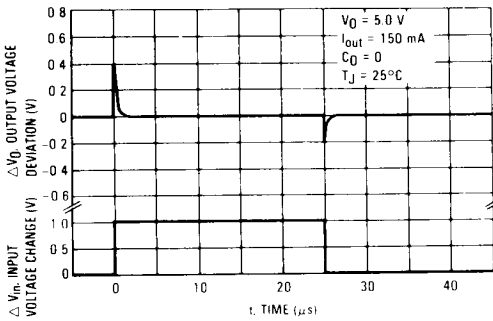

FIGURE 12 — LOAD TRANSIENT RESPONSE

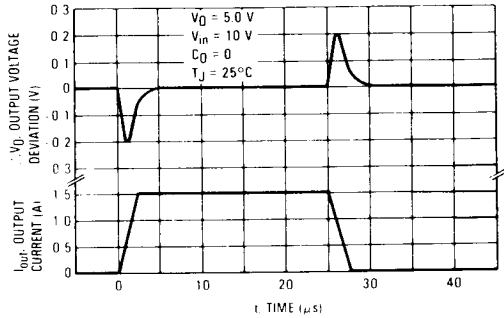

FIGURE 13 — WORST CASE POWER DISSIPATION versus AMBIENT TEMPERATURE (Case 221A)

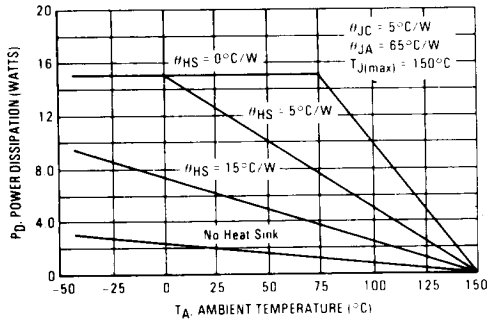
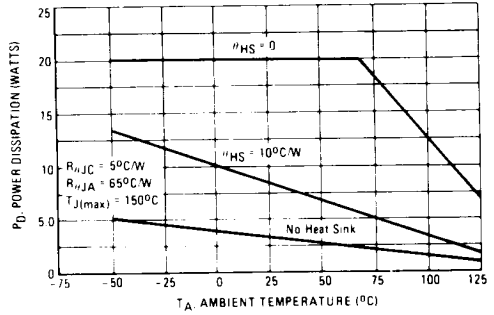

FIGURE 14 — WORST CASE POWER DISSIPATION versus AMBIENT TEMPERATURE (Case 1)



Design Considerations

The LM140 Series of fixed voltage regulators are designed with Thermal Overload Protection that shuts down the circuit when subjected to an excessive power overload condition, Internal Short-Circuit Protection that limits the maximum current the circuit will pass, and Output Transistor Safe-Area Compensation that reduces the output short-circuit current as the voltage across the pass transistor is increased.

In many low current applications, compensation capacitors are not required. However, it is recommended that the regulator input be bypassed with a capacitor if the regulator is connected to the power supply filter

APPLICATIONS INFORMATION

with long wire lengths, or if the output load capacitance is large. An input bypass capacitor should be selected to provide good high-frequency characteristics to insure stable operation under all load conditions. A 0.33 μF or larger tantalum, mylar, or other capacitor having low internal impedance at high frequencies should be chosen. The bypass capacitor should be mounted with the shortest possible leads directly across the regulators input terminals. Normally good construction techniques should be used to minimize ground loops and lead resistance drops since the regulator has no external sense lead.

FIGURE 15 — CURRENT REGULATOR

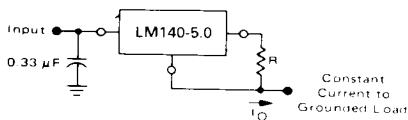

These regulators can also be used as a current source when connected as above. In order to minimize dissipation the LM140-5.0 is chosen in this application. Resistor R determines the current as follows:

$$I_O = \frac{5.0 \text{ V}}{R} + I_Q$$

$I_Q \cong 1.5 \text{ mA}$ over line and load changes

For example, a 1-ampere current source would require R to be a 5-ohm, 10-W resistor and the output voltage compliance would be the input voltage less 7.0 volts.

FIGURE 16 — ADJUSTABLE OUTPUT REGULATOR

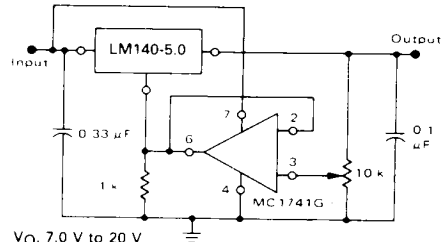

V_O : 7.0 V to 20 V
 $V_{IN} - V_O \cong 2.0 \text{ V}$

The addition of an operational amplifier allows adjustment to higher or intermediate values while retaining regulation characteristics. The minimum voltage obtainable with this arrangement is 2.0 volts greater than the regulator voltage.

FIGURE 17 — CURRENT BOOST REGULATOR

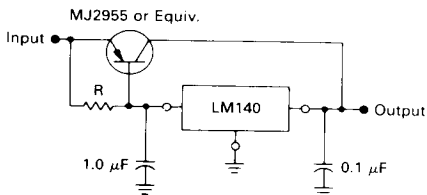

The LM140 series can be current boosted with a PNP transistor. The MJ2955 provides current to 5.0 amperes. Resistor R in conjunction with the V_{BE} of the PNP determines when the pass transistor begins conducting; this circuit is not short-circuit proof. Input-output differential voltage minimum is increased by V_{BE} of the pass transistor.

FIGURE 18 — SHORT-CIRCUIT PROTECTION

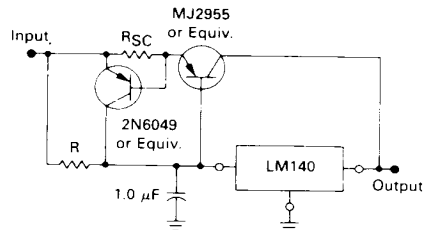

The circuit of Figure 17 can be modified to provide supply protection against short circuits by adding a short-circuit sense resistor, R_{SC} , and an additional PNP transistor. The current sensing PNP must be able to handle the short-circuit current of the three-terminal regulator. Therefore, a four-ampere plastic power transistor is specified.