

# HIGH VOLTAGE POWER MOSFETS T-39-15

The IXYS family of high voltage N- and P-channel Power MOSFETs is designed to provide superior performance and ruggedness in high voltage switching applications.

In addition, they are directly compatible as second sources to other industry standard Power MOSFETs in the 450 to 1000 volt range. Major improvements were made possible due to HDMOS which lowers the typical on-resistance yet maintains very high transconductance. The designer is able to reduce the gate drive requirements; yet can obtain very high switching speeds.

At 1000 volts, IXYS has more current ratings than any other supplier. IXYS MOSFETs exhibit excellent stability at high temperatures and offer the highest ruggedness of any device available.

## High Voltage P-Channel MOSFETs

IXYS offers the broadest line of high voltage P-channel MOSFETs ranging from 150 to 500 volts. At 500 volts there are eight ratings to choose from, starting at 2 Amps and going up to 11 Amps. These are the industry's highest power P-channel devices. HDMOS P-channel Power MOSFETs exhibit superior ruggedness to unclamped inductive energy as well as dynamic and static  $dv/dt$ . They can be combined with IXYS' N-channel Power MOSFETs to form "complementary pairs" and half bridge configurations to reduce the gate drive complexity of the upper power device.

## IXYS TECHNOLOGY OFFERS SUPERIOR RUGGEDNESS AND RELIABILITY

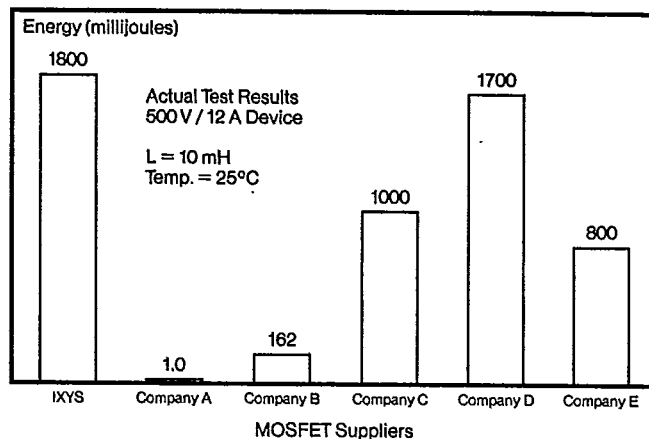

## Guaranteed Ruggedness

IXYS' high voltage Power MOSFETs are available with an optional ruggedness screen providing the highest levels of ruggedness currently offered in industry standard MOSFETs. By adding an "R" suffix at the end of the part number, IXYS guarantees that

100% of the devices shipped will pass the minimum UIS (Unclamped Inductive Surge) specified on the data sheet. For detailed information on the actual guaranteed UIS specifications, refer to the IXYS published spec sheet or call your local IXYS representative.

T-39-1.5

**N-Channel MOSFETs**

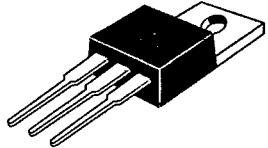
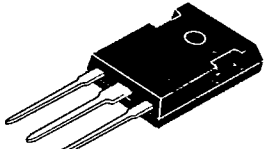
Part Number	Drain-Source Voltage $V_{(BR)DSS}$ (Volts)	Drain Current $I_D$ @ 25 °C Case		On Resistance $R_{DS(on)}$ (Ohms)	Input Cap. $C_{iss}$ (pF)	Power Diss. $P_D$ Max (Watts)	Notes	Case Style
		$I_{D(Cont)}$ (Amps)	$I_{D(Pulsed)}$ (Amps)					
IXTP4N100A	1000	4	16	3.3	1800	135		 <p>TO-220</p>
IXTP4N100	1000	4	16	4.3	1800	135		
IXTP2N100A	1000	2	8	6.0	900	75		
IXTP2N100	1000	2	8	8.0	900	75		
IXTP4N95A	950	4	16	3.3	1800	135		
IXTP4N95	950	4	16	4.3	1800	135		
IXTP2N95A	950	2	8	6.0	900	75		
IXTP2N95	950	2	8	8.0	900	75		
IXTP4N90A	900	4	16	2.5	1800	135		
IXTP4N90	900	4	16	3.5	1800	135		
IXTP3N90A	900	3	12	4.6	900	75		
IXTP3N90	900	3	12	6.0	900	75		
IXTP4N80A	800	4	16	2.5	1800	135		
IXTP4N80	800	4	16	3.5	1800	135		
IXTP3N80A	800	3	12	4.6	900	75		
IXTP3N80	800	3	12	6.0	900	75		
IXTP6N60A	600	6	24	1.2	1800	135		
IXTP6N60	600	6	24	1.5	1800	135		
IXTP4N60A	600	4	16	2.1	900	75		
IXTP4N60	600	4	16	2.4	900	75		
IXTP7N50A	500	7	28	0.85	1570	135	1	
IXTP7N50	500	7	28	1.1	1570	135	1	
IXTP4N50A	500	4	16	1.5	700	75	1	
IXTP4N50	500	4	16	2.0	700	75	1	
IXTP7N45A	450	7	28	0.85	1570	135	1	
IXTP7N45	450	7	28	1.1	1570	135	1	
IXTP4N45A	450	4	16	1.5	700	75	1	
IXTP4N45	450	4	16	2.0	700	75	1	
IXTH5N100A	1000	5	20	2.0	2800	175		 <p>TO-247</p>
IXTH5N100	1000	5	20	2.6	2800	175		
IXTH5N95A	950	5	20	2.0	2800	175		
IXTH5N95	950	5	20	2.6	2800	175		
IXTH6N90A	900	6	24	1.5	2800	175		
IXTH6N90	900	6	24	2.2	2800	175		
IXTH6N80A	800	6	24	1.5	2800	175		
IXTH6N80	800	6	24	2.2	2800	175		
IXTH10N60A	600	10	40	0.55	2700	175	1	
IXTH10N60	600	10	40	0.75	2700	175	1	
IRFP460	500	20	80	0.27	4100	250	1	
IXTH15N50A	500	15	60	0.4	2700	175	1	
IRFP450	500	14	56	0.4	2700	180	1	
IXTH12N50A	500	12	48	0.4	2700	175	1	
IXTH12N50	500	12	48	0.5	2700	175	1	
IRFP452	500	12	48	0.5	2700	180	1	
IXTH15N45A	450	15	60	0.4	2700	175	1	
IRFP451	450	14	56	0.4	2700	180	1	
IXTH12N45A	450	12	48	0.4	2700	175	1	

Note: 1. Input capacitance values are typical.

**N-Channel MOSFETs**

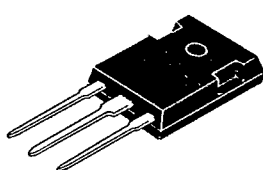
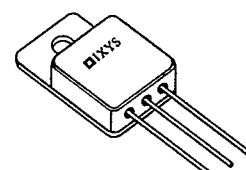
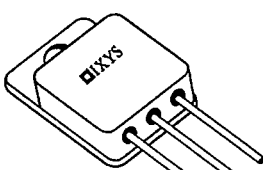
Part Number	Drain-Source Voltage V <sub>(BR)DSS</sub> (Volts)	Drain Current I <sub>D</sub> @ 25 °C Case		On Resistance R <sub>DS(on)</sub> (Ohms)	Input Cap. C <sub>iss</sub> (pF)	Power Diss. P <sub>D</sub> Max (Watts)	Notes	Case Style
		I <sub>D(Cont)</sub> (Amps)	I <sub>D(Pulsed)</sub> (Amps)					
IXTH12N45	450	12	48	0.5	2700	175	1	TO-247 
IRFP453	450	12	48	0.5	2700	180	1	
IRFP360	400	25	100	0.2	4000	250	1	
IRFP350	400	16	64	0.3	3000	180	1	
IRFP352	400	14	56	0.4	3000	180	1	
IRFP351	350	16	64	0.3	3000	180	1	
IRFP353	350	14	56	0.4	3000	180	1	
IRFP254	250	25	100	0.12	2700	180	1	
IRFP250	200	31	120	0.085	2600	180	1	
IRFP252	200	26	100	0.12	2600	180	1	
IRFP251	150	31	120	0.085	2600	180	1	
IRFP253	150	26	100	0.12	2600	180	1	
IRFP150	100	41	160	0.055	3000	180	1	
IRFP152	100	34	140	0.080	3000	180	1	
IRFP151	60	41	160	0.055	3000	180	1	
IRFP153	60	34	140	0.080	3000	180	1	
IXTR5N50	500	5	20	1.5	900	75		TO-220H 
IXTR6N40	400	6	24	1.0	900	75		
IXTR10N20	200	10	40	0.4	900	75		
IXTR15N10	100	15	60	0.18	900	75		
IXTL9N65	650	9	36	0.7	2800	125		
IXTL5N65	650	5	20	1.6	1800	100		TO-254 
IXTL10N60	600	10	40	0.55	2800	125		
IXTL6N60	600	6	24	1.2	1800	100		
IXTL450	500	12	48	0.4	2800	125		
IXTL7N50	500	7	28	0.85	1800	100		
IXTL350	400	14	56	0.3	2800	125		
IXTL9N40	400	9	36	0.56	1800	100		
IXTL250	200	25	100	0.1	2800	125		
IXTL15N20	200	15	60	0.21	1800	100		
IXTL150	100	25	100	0.065	2800	125		
IXTL24N10	100	24	96	0.18	1800	100		

Note: 1. Input capacitance values are typical.

N-Channel MOSFETs

Part Number	Drain-Source Voltage V <sub>(BR)DSS</sub> (Volts)	Drain Current I <sub>D</sub> @ 25 °C Case		On Resistance R <sub>DS(on)</sub> (Ohms)	Input Cap. C <sub>iss</sub> (pF)	Power Diss. P <sub>D</sub> Max (Watts)	Notes	Case Style
		I <sub>D(Cont)</sub> (Amps)	I <sub>D(Pulsed)</sub> (Amps)					
IXTM5N100A	1000	5	20	2.0	2800	175		TO-204 (TO-3) 
IXTM5N100	1000	5	20	2.6	2800	175		
IXTM4N100A	1000	4	16	3.3	1800	135		
IXTM4N100	1000	4	16	4.3	1800	135		
IXTM2N100A	1000	2	8	6.0	900	75		
IXTM2N100	1000	2	8	8.0	900	75		
IXTM5N95A	950	5	20	2.0	2800	175		
IXTM5N95	950	5	20	2.6	2800	175		
IXTM4N95A	950	4	16	3.3	1800	135		
IXTM4N95	950	4	16	4.3	1800	135		
IXTM2N95A	950	2	8	6.0	900	75		
IXTM2N95	950	2	8	8.0	900	75		
IXTM6N90A	900	6	24	1.5	2800	175		
IXTM6N90	900	6	24	2.2	2800	175		
IXTM4N90A	900	4	16	2.5	1800	135		
IXTM4N90	900	4	16	3.5	1800	135		
IXTM3N90A	900	3	12	4.6	900	75		
IXTM3N90	900	3	12	6.0	900	75		
IXTM6N80A	800	6	24	1.5	2800	175		
IXTM6N80	800	6	24	2.2	2800	175		
IXTM4N80A	800	4	16	2.5	1800	135		
IXTM4N80	800	4	16	3.5	1800	135		
IXTM3N80A	800	3	12	4.6	900	75		
IXTM3N80	800	3	12	6.0	900	75		
IXTM10N60A	600	10	40	0.55	2700	175	1	
IXTM10N60	600	10	40	0.75	2700	175	1	
IXTM6N60A	600	6	24	1.2	1570	135	1	
IXTM6N60	600	6	24	1.5	1570	135	1	
IXTM4N60A	600	4	16	2.1	700	75	1	
IXTM4N60	600	4	16	2.4	700	75	1	
IRF460	500	20	80	0.27	4100	300	1	
IXTM15N50A	500	15	60	0.4	2700	175	1	
IRF450	500	14	56	0.4	2700	150	1	
IXTM12N50A	500	12	48	0.4	2700	175	1	
2N6770	500	12	25	0.4	3000	150		
IXTM12N50	500	12	48	0.5	2700	175	1	
IRF452	500	12	48	0.5	2700	150	1	
IXTM7N50A	500	7	28	0.85	1570	135	1	
IXTM7N50	500	7	28	1.1	1570	135	1	
2N6762	500	4.5	7	1.5	800	75		
IXTM4N50A	500	4	16	1.5	700	75	1	
IXTM4N50	500	4	16	2.0	700	75	1	
IXTM15N45A	450	15	60	0.4	2700	175	1	
IRF451	450	14	56	0.4	2700	150	1	
IXTM12N45A	450	12	48	0.4	2700	175	1	
IXTM12N45	450	12	48	0.5	2700	175	1	
IRF453	450	12	48	0.5	2700	150	1	

Note: 1. Input capacitance values are typical.

**N-Channel MOSFETs**

Part Number	Drain-Source Voltage V <sub>(BR)DSS</sub> (Volts)	Drain Current I <sub>D</sub> @ 25 °C Case		On Resistance R <sub>DS(on)</sub> (Ohms)	Input Cap. C <sub>iss</sub> (pF)	Power Diss. P <sub>D</sub> Max (Watts)	Notes	Case Style
		I <sub>D(Cont)</sub> (Amps)	I <sub>D(Pulsed)</sub> (Amps)					
2N6769	450	11	20	0.5	3000	150		TO-204 (TO-3)
IXTM7N45A	450	7	28	0.85	1570	135	1	
IXTM7N45	450	7	28	1.1	1570	135	1	
IXTM4N45A	450	4	16	1.5	700	75	1	
IXTM4N45	450	4	16	2.0	700	75	1	
2N6761	450	4	6	2.0	800	75		
IRF360	400	25	100	0.2	4000	300	1	
IRF350	400	16	64	0.3	3000	150	1	
2N6768	400	14	25	0.3	3000	150		
IRF352	400	14	56	0.4	3000	150	1	
2N6760	400	5.5	8	1.0	800	75		
IRF351	350	16	64	0.3	3000	150	1	
IRF353	350	14	56	0.4	3000	150	1	
2N6767	350	12	20	0.4	3000	150		
2N6759	350	4.5	7	1.5	800	75		
IRF254	250	25	100	0.12	2700	150	1	
IRF250	200	31	120	0.085	2600	150	1	
2N6766	200	30	60	0.085	3000	150		
IRF252	200	26	100	0.12	2600	150	1	
2N6758	200	9	15	0.4	800	75		
IRF251	150	31	120	0.085	2600	150	1	
IRF253	150	26	100	0.12	2600	150	1	
2N6765	150	25	50	0.12	3000	150		
2N6757	150	8	12	0.6	800	75		
IRF150	100	41	160	0.055	3000	150	1	
2N6764	100	38	70	0.055	3000	150		
IRF152	100	34	140	0.080	3000	150	1	
2N6756	100	14	30	0.18	800	75		
IRF151	60	41	160	0.055	3000	150	1	
IRF153	60	34	140	0.080	3000	150	1	
2N6763	60	31	60	0.08	3000	150		
2N6755	60	12	25	0.25	800	75		
2N7103	650	14	28	0.55	4200	150		TO-210AC (TO-61)
IXTS10N65	650	10	40	0.7	2800	125		
IXTS11N60	600	11	44	0.55	2800	125		
2N7102	500	20	40	0.3	4200	150		
IXTS13N50	500	13	52	0.4	2800	125		
2N6965	500	13	26	0.4	3000	150		
2N7101	400	24	48	0.2	4200	150		
IXTS15N40	400	15	60	0.3	2800	125		
2N6964	400	15	30	0.3	3000	150		
2N7100	200	40	80	0.06	4200	150		
IXTS30N20	200	30	120	0.09	2800	125		
2N6963	200	30	60	0.09	3000	150		
IXTS30N10	100	30	120	0.06	2800	125		
2N6962	100	30	60	0.06	3000	150		

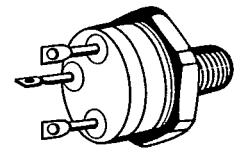
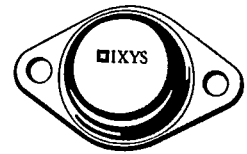

Note: 1. Input capacitance values are typical.

T-39-23

**P-Channel MOSFETs**

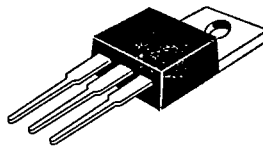
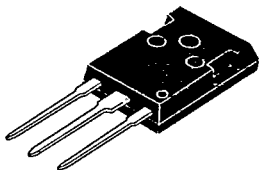
Part Number	Drain-Source Voltage $V_{(BR)DSS}$ (Volts)*	Drain Current $I_D$ @ 25 °C Case		On Resistance $R_{DS(on)}$ (Ohms)	Input Cap. $C_{iss}$ (pF)	Power Diss. $P_D$ Max (Watts)	Notes	Case Style
		$I_{D(Cont)}$ (Amps)*	$I_{D(Pulse)}$ (Amps)*					
IXTP5P50	500	5	20	2.5	1800	125		TO-220
IXTP4P50	500	4	16	3.3	1800	125		
IXTP3P50	500	3	12	4.5	900	75		
IXTP2P50	500	2	8	5.5	900	75		
IXTP5P45	450	5	20	2.5	1800	125		
IXTP4P45	450	4	16	3.3	1800	125		
IXTP3P45	450	3	12	4.5	900	75		
IXTP2P45	450	2	8	5.5	900	75		
IXTP9P25	250	9	36	0.7	1800	125		
IXTP8P25	250	8	32	0.9	1800	125		
IXTP6P25	250	6	24	1.1	900	75		
IXTP5P25	250	5	20	1.5	900	75		
IXTP11P20	200	11	44	0.5	1800	125		
IXTP9P20	200	9	36	0.7	1800	125		
IXTP7P20	200	7	28	0.8	900	75		
IXTP5P20	200	5	20	1.2	900	75		
IXTP11P15	150	11	44	0.5	1800	125		
IXTP9P15	150	9	36	0.7	1800	125		
IXTP7P15	150	7	28	0.8	900	75		
IXTP5P15	150	5	20	1.2	900	75		
IXTH11P50	500	11	44	0.75	4000	200		TO-247
IXTH10P50	500	10	40	0.9	4000	200		
IXTH8P50	500	8	32	1.2	2800	150		
IXTH7P50	500	7	28	1.5	2800	150		
IXTH11P45	450	11	44	0.75	4000	200		
IXTH10P45	450	10	40	0.9	4000	200		
IXTH8P45	450	8	32	1.2	2800	150		
IXTH7P45	450	7	28	1.5	2800	150		
IXTH20P25	250	20	80	0.24	4000	200		
IXTH17P25	250	17	68	0.3	4000	200		
IXTH13P25	250	13	52	0.4	2800	150		
IXTH12P25	250	12	48	0.5	2800	150		
IXTH22P20	200	22	88	0.2	4000	200		
IXTH19P20	200	19	76	0.25	4000	200		
IXTH15P20	200	15	60	0.3	2800	150		
IXTH13P20	200	13	52	0.4	2800	150		
IXTH22P15	150	22	88	0.2	4000	200		
IXTH19P15	150	19	76	0.25	4000	200		
IXTH15P15	150	15	60	0.3	2800	150		
IXTH13P15	150	13	52	0.4	2800	150		

\* All voltages and currents are negative.

**P-Channel MOSFETs**

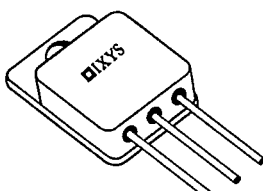
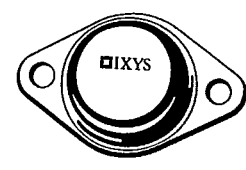
Part Number	Drain-Source Voltage $V_{(BR)DSS}$ (Volts)*	Drain Current $I_D$ @ 25 °C Case		On Resistance $R_{DS(on)}$ (Ohms)	Input Cap. $C_{iss}$ (pF)	Power Diss. $P_D$ Max (Watts)	Notes	Case Style
		$I_{D(Cont)}$ (Amps)*	$I_{D(Pulsed)}$ (Amps)*					
IXTL10P50	500	10	40	0.75	4000	175	1	
IXTL7P50	500	7	28	1.2	2800	125		
IXTL4P50	500	4	16	2.5	1800	100		
IXTL11P40	400	11	44	0.65	4000	175	1	
IXTL8P40	400	8	32	1.0	2800	125		
IXTL5P40	400	5	20	1.7	1800	100		
IXTL21P20	200	21	84	0.2	4000	175	1	
IXTL14P20	200	14	56	0.3	2800	125		
IXTL10P20	200	10	40	0.5	1800	100		
IXTL25P10	100	25	100	0.08	4000	175	1	
IXTL24P10	100	24	96	0.12	2800	125		
IXTL17P10	100	17	68	0.2	1800	100		
IXTM11P50	500	11	44	0.75	4000	200		
IXTM10P50	500	10	40	0.9	4000	200		
IXTM8P50	500	8	32	1.2	2800	150		
IXTM7P50	500	7	28	1.5	2800	150		
IXTM5P50	500	5	20	2.5	1800	125		
IXTM4P50	500	4	16	3.3	1800	125		
IXTM3P50	500	3	12	4.5	900	75		
IXTM2P50	500	2	8	5.5	900	75		
IXTM11P45	450	11	44	0.75	4000	200		
IXTM10P45	450	10	40	0.9	4000	200		
IXTM8P45	450	8	32	1.2	2800	150		
IXTM7P45	450	7	28	1.5	2800	150		
IXTM5P45	450	5	20	2.5	1800	125		
IXTM4P45	450	4	16	3.3	1800	125		
IXTM3P45	450	3	12	4.5	900	75		
IXTM2P45	450	2	8	5.5	900	75		
IXTM20P25	250	20	80	0.24	4000	200		
IXTM17P25	250	17	68	0.3	4000	200		
IXTM13P25	250	13	52	0.4	2800	150		

Note: 1. New part number reflects TO-254 package.

\* All voltages and currents are negative.

**P-Channel MOSFETs**

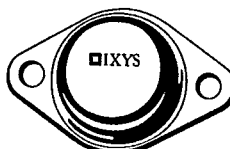
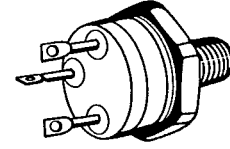
Part Number	Drain-Source Voltage $V_{(BR)DSS}$ (Volts)*	Drain Current $I_D$ @ 25 °C Case		On Resistance $R_{DS(on)}$ (Ohms)	Input Cap. $C_{iss}$ (pF)	Power Diss. $P_D$ Max (Watts)	Notes	Case Style
		$I_{D(Cont)}$ (Amps)*	$I_{D(Pulse)}$ (Amps)*					
IXTM12P25	250	12	48	0.5	2800	150		
IXTM9P25	250	9	36	0.7	1800	125		
IXTM8P25	250	8	32	0.9	1800	125		
IXTM6P25	250	6	24	1.1	900	75		
IXTM5P25	250	5	20	1.5	900	75		
IXTM22P20	200	22	88	0.2	4000	200		
IXTM19P20	200	19	76	0.25	4000	200		
IXTM15P20	200	15	60	0.3	2800	150		
IXTM13P20	200	13	52	0.4	2800	150		
IXTM11P20	200	11	44	0.5	1800	125		
IXTM9P20	200	9	36	0.7	1800	125		
IXTM7P20	200	7	28	0.8	900	75		
2N6806	200	6.5	26	0.8	800	75		
IXTM5P20	200	5	20	1.2	900	75		
IXTM22P15	150	22	88	0.2	4000	200		
IXTM19P15	150	19	76	0.25	4000	200		
IXTM15P15	150	15	60	0.3	2800	150		
IXTM13P15	150	13	52	0.4	2800	150		
IXTM11P15	150	11	44	0.5	1800	125		
IXTM9P15	150	9	36	0.7	1800	125		
IXTM7P15	150	7	28	0.8	900	75		
IXTM5P15	150	5	20	1.2	900	75		
2N6804	100	12	48	0.3	800	75		
IXTS10P50	500	10	40	0.75	4000	165		
IXTS11P40	400	11	44	0.65	4000	165		
IXTS20P20	200	20	80	0.2	4000	165		
IXTS30P10	100	30	120	0.08	4000	165		

\* All voltages and currents are negative.



# DETAILED PACKAGE OUTLINES

T-91-20

**TO-220 AB**

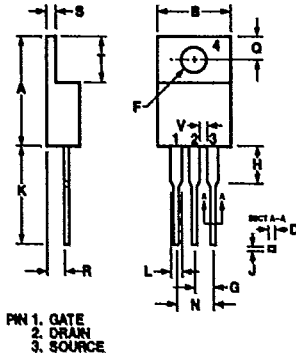

Dim.	Millimeter		Inches	
	Min.	Max.	Min.	Max.
A	14.23	16.51	.560	.650
B	9.66	10.66	.380	.420
C	3.56	4.82	.140	.190
D	0.64	0.89	.025	.035
F	3.54	4.08	.139	.161
G	2.29	2.79	.090	.110
H	-	6.35	-	.250
J	0.51	.76	.020	.030
K	12.70	14.73	.500	.580
L	1.15	1.77	.045	.070
N	4.83	5.33	.190	.210
Q	2.54	3.42	.100	.135
R	2.04	2.49	.080	.115
S	0.64	1.39	.025	.055
T	5.85	6.85	2.30	2.70
V	1.15	-	.045	-

**CONFORMS TO OUTLINE TO-220 (IR H-7)**  
Dimensions in Millimeters (Inches)

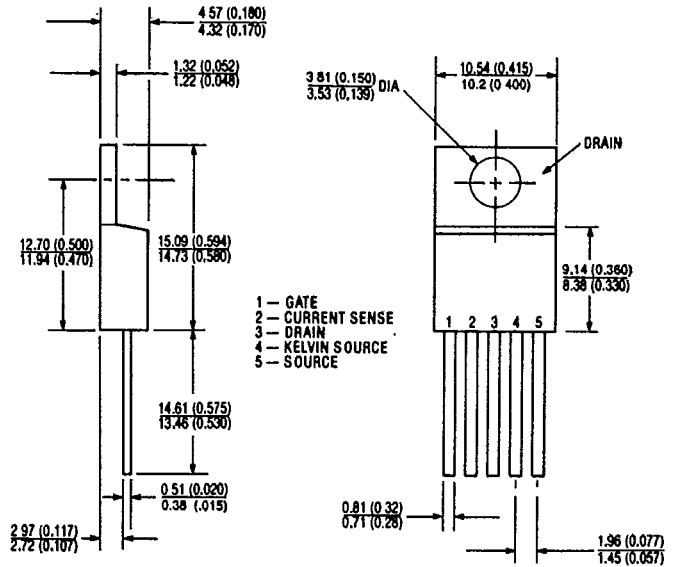

**TO-247 (3 LEADED)**

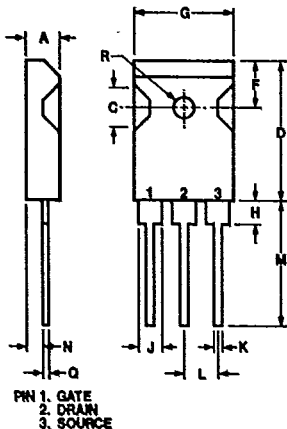

Dim.	Millimeter		Inches	
	Min.	Max.	Min.	Max.
A	4.7	5.3	.185	.209
C	4.5	6.0	.178	.236
D	19.7	21.4	.776	.843
F	5.3	6.1	.209	.240
G	15.3	15.9	.602	.625
H	3.7	4.3	.146	.169
J	1.95	2.4	.077	.094
J <sub>1</sub>	2.97	3.4	.117	.134
K	1.0	1.4	.040	.055
L	5.4	5.5	.213	.217
M	19.9	20.2	.783	.795
N	2.2	2.6	.087	.102
Q	0.4	0.8	.016	.031
R	2.9	3.3	.114	.129

**TO-247 (5 LEADED)**

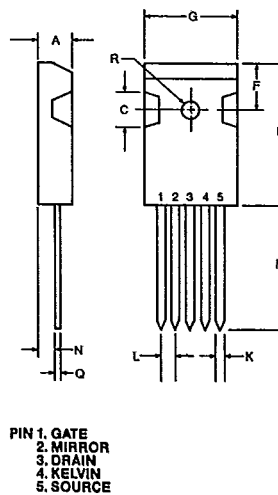

Dim.	Millimeter		Inches	
	Min.	Max.	Min.	Max.
A	4.7	5.3	.185	.209
C	4.5	6.0	.178	.236
D	19.7	21.4	.776	.843
F	5.3	6.1	.209	.240
G	15.3	15.9	.602	.625
K	1.1	1.3	.043	.051
L	2.51	2.56	.099	.101
M	19.9	20.2	.783	.795
N	2.2	2.6	.087	.102
Q	0.4	0.8	.016	.031
R	2.9	3.3	.114	.129

**TO-238**  
Dimensions in Millimeters

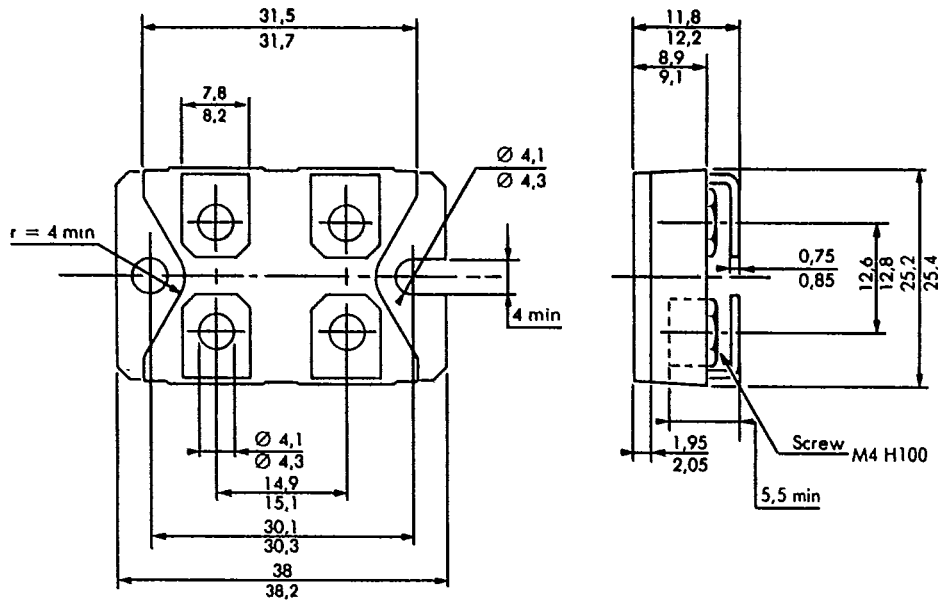

**Y-4**  
Dimensions in Millimeters

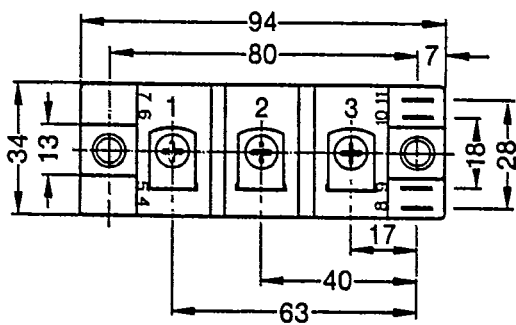
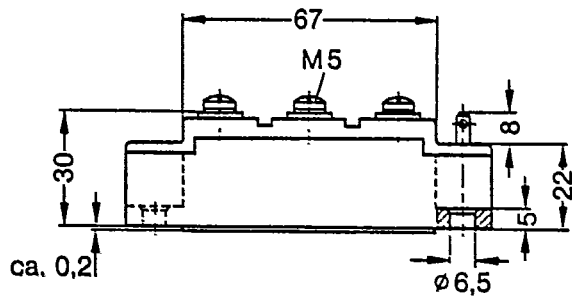

**Y-3**  
Dimensions in Millimeters

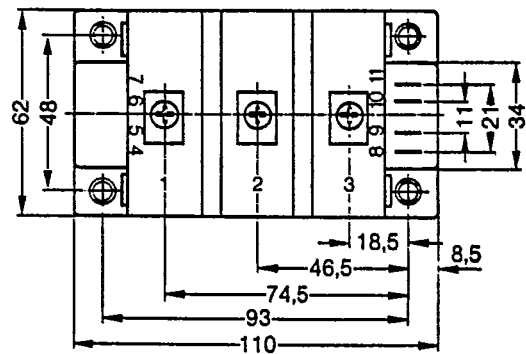
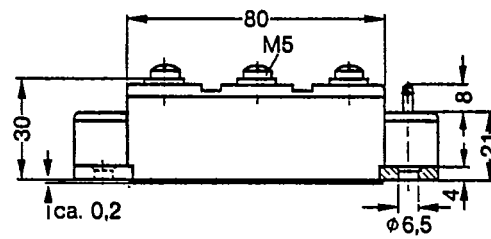

TO-220 HERMETIC

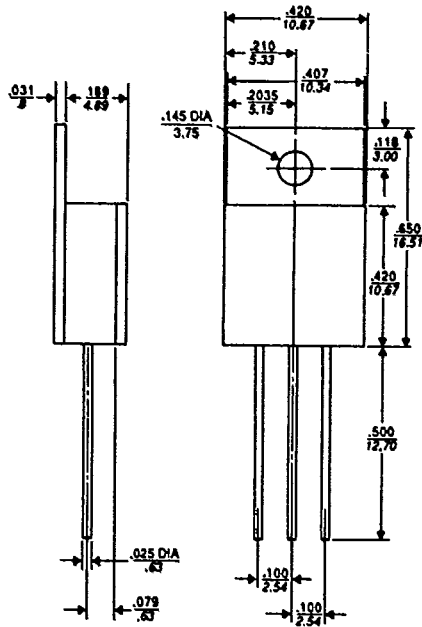

TO-204 AE

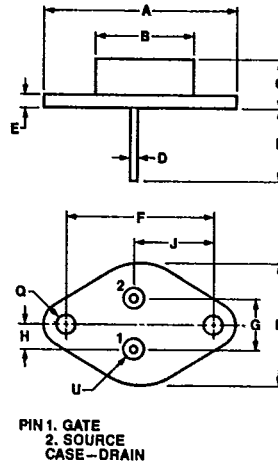

Dim.	Millimeter	Max.	Inches	Max.
A	—	39.37	—	1.55
B	—	19.71	—	.776
C	7.62	10.16	.300	.400
D	1.47	1.57	.058	.062
E	1.52	3.43	.060	.135
F	30.15	BSC	1.187	BSC
G	10.67	11.18	.420	.440
H	5.33	6.10	.210	.240
J	16.68	17.12	.657	.674
K	11.20	11.98	.441	.472
Q	3.86	4.11	.152	.162
R	24.84	25.27	.978	.995

TO-204 AA

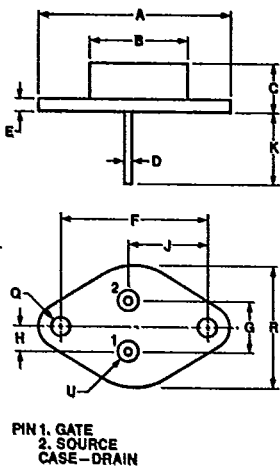

Dim.	Millimeter	Max.	Inches	Max.
A	—	39.37	—	.155
B	—	19.71	—	.776
C	6.35	8.89	.250	.350
D	.097	1.09	.038	.043
E	—	3.43	—	.135
F	30.15	BSC	1.187	BSC
G	10.67	11.18	.420	.440
H	5.33	6.10	.210	.240
J	16.68	17.12	.657	.674
K	11.20	11.98	.441	.472
Q	3.86	4.11	.152	.162
R	24.84	25.47	.978	1.00

TO-254 HERMETIC

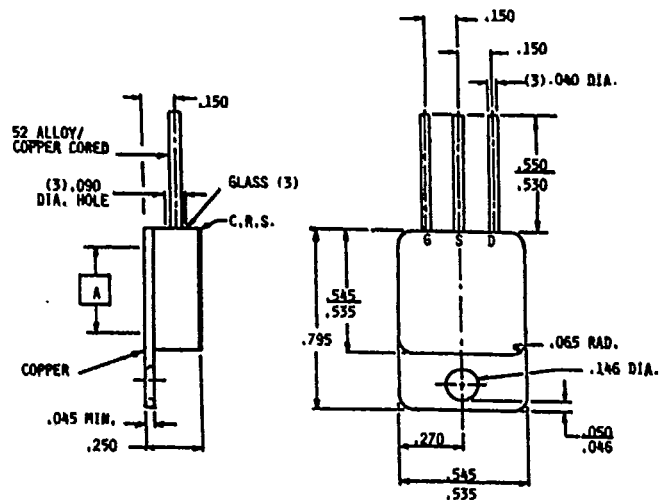

**CONFORMS TO JEDEC OUTLINE TO-210AC (TO-61)**  
Dimensions in Millimeters (Inches)

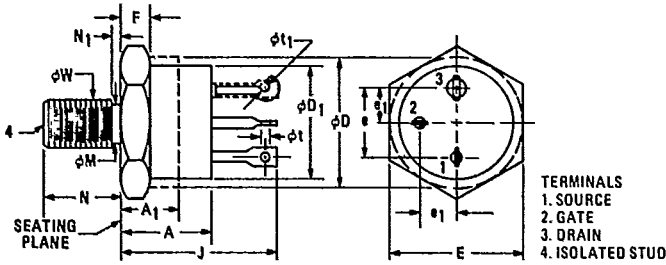

TERMINALS  
1. SOURCE  
2. GATE  
3. DRAIN  
4. ISOLATED STUD

Symbol	Inches		Millimeters		Notes
	Min.	Max.	Min.	Max.	
A	0.325	0.450	8.26	11.68	
A <sub>1</sub>	0.270		6.86		2
φD	0.610	0.687	15.49	17.45	2
φD <sub>1</sub>	0.570	0.610	14.48	15.49	
E	0.667	0.687	16.94	17.45	
e	0.340	0.415	8.64	10.54	5
e <sub>1</sub>	0.170	0.213	4.32	5.41	5
F	0.090	0.150	2.29	3.81	1

Symbol	Inches		Millimeters		Notes
	Min.	Max.	Min.	Max.	
J	0.640	0.875	16.26	22.23	
φM	0.220	0.249	5.59	6.32	
N	0.422	0.455	10.72	11.56	
N <sub>1</sub>		0.090		2.29	
φt	0.055	0.072	1.19	1.83	
φt <sub>1</sub>	0.046	0.077	1.17	1.96	4
φW	0.2225	0.2768	5.561	5.761	3

NOTES

1. DIMENSION DOES NOT INCLUDE SEALING FLANGES.
2. PACKAGE CONTOUR OPTIONAL WITHIN DIMENSIONS SPECIFIED.
3. PITCH DIAMETER - THREAD 1/4 28 UNF 2A (COATED).  
REFERENCE ISCREW THREAD STANDARDS FOR FEDERAL SERVICES - HANDBOOK H 281.
4. THIS TERMINAL CAN BE FLATTENED AND PIERCED OR HOOK TYPE.
5. POSITION OF LEADS IN RELATION TO THE HEXAGON IS NOT CONTROLLED.

**QUADPAC**

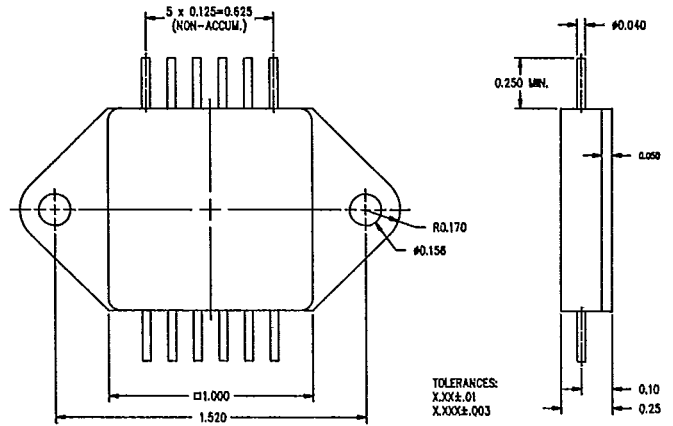

**Z-Pac**

