

# LP5990

## Micropower 200mA CMOS Low Dropout Voltage Regulator

### General Description

The LP5990 regulator is designed to meet the requirements of portable, battery-powered systems providing an accurate output voltage, low noise and low quiescent current.

The LP5990 will provide a 1.8V output from a low input voltage of 2.2V and can provide 200mA to an external load.

When switched into shutdown mode via a logic signal at the enable pin, the power consumption is reduced to virtually zero.

Fast shut-down is achieved by the push pull architecture.

The LP5990 is designed to be stable with space saving 0402 ceramic capacitors as small as 1 $\mu$ F, this gives an overall solution size of < 2.5mm<sup>2</sup>.

Performance is specified for a -40°C to 125°C junction temperature range.

The device is available in micro SMD Package (0.4mm pitch) and is available with 1.2V, 1.3V, 1.8V, 2.8V, 3.0V, 3.3V and 3.6V outputs. Lower voltage options down to 0.8V are available on request. For all other output voltage options please contact your local NSC sales office.

### Features

- Operation from 2.2V to 5.5V input
- $\pm 1\%$  accuracy over temp range
- Output voltage from 0.8V to 3.6V in 50mV increments
- 30  $\mu$ A Quiescent current (enabled)
- 10nA Quiescent current (disabled)
- 160mV dropout at 200mA load
- 60  $\mu$ V<sub>RMS</sub> Output voltage noise
- 60  $\mu$ s start-up time
- 500 $\mu$ s shut-down time
- PSRR 55 dB at 10 kHz
- Stable with 0402 1.0 $\mu$ F ceramic capacitors
- Logic controlled enable
- Thermal-overload and short-circuit protection

### Package

4-Bump micro SMD, 0.4mm  
pitch  
(lead free)

866  $\mu$ m x 917  $\mu$ m

### Applications

- Cellular phones
- Hand-held information appliances

### Typical Application Circuit

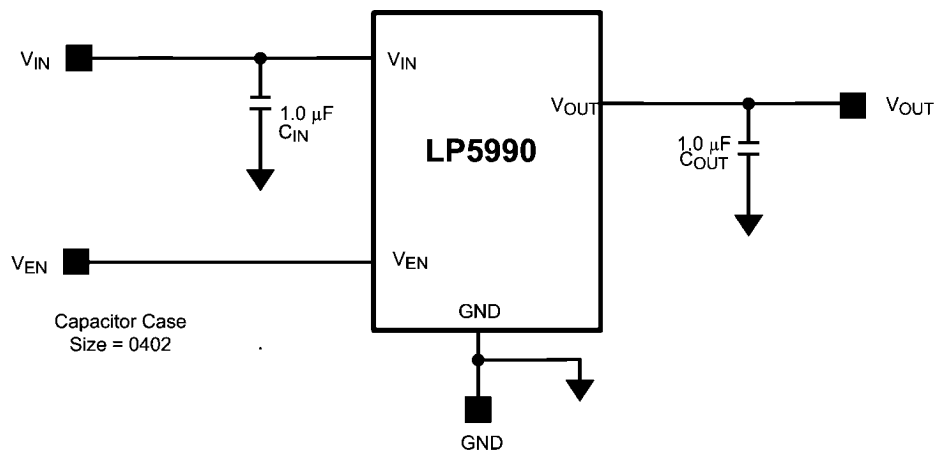

20184801

## Connection Diagrams

4-Bump Thin micro SMD Package, 0.4mm pitch  
NS Package Number TMD04

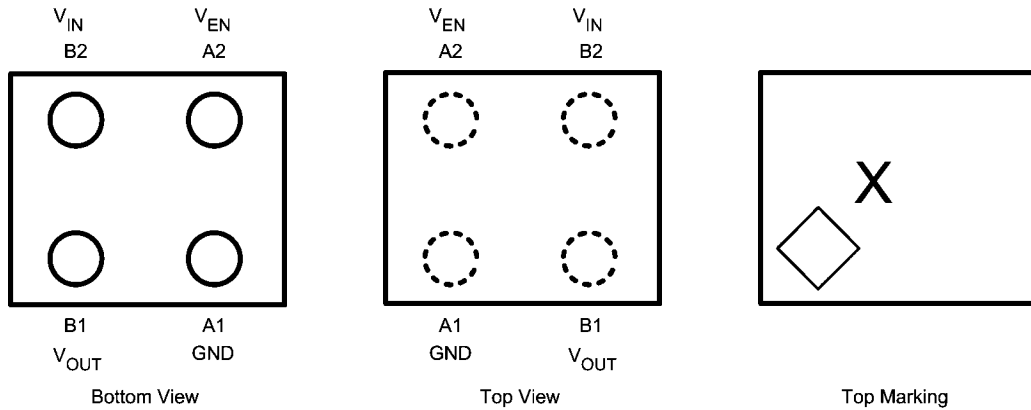

20184802

The actual physical placement of the package marking will vary from part to part.

## Pin Descriptions

| Pin No.          | Symbol    | Name and Function   |
|------------------|-----------|---|
| <b>micro SMD</b> |           |   |
| A2               | $V_{EN}$  | Enable input; disables the regulator when $\leq 0.35V$ . Enables the regulator when $\geq 1.0V$ .                         |
| A1               | GND       | Common ground.  |
| B1               | $V_{OUT}$ | Output voltage. A $1.0 \mu F$ Low ESR capacitor should be connected to this Pin. Connect this output to the load circuit. |
| B2               | $V_{IN}$  | Input voltage supply. A $1.0 \mu F$ capacitor should be connected at this input.  |

## Ordering Information

### micro SMD Package (Lead Free)

| Output Voltage (V) | Supplied As             |                        |
|--------------------|-------------------------|------------------------|
|                    | 250 Units Tape and Reel | 3k Units Tape and Reel |
| 1.2                | LP5990TM-1.2/NOPB       | LP5990TMX-1.2/NOPB     |
| 1.3                | LP5990TM-1.3/NOPB       | LP5990TMX-1.3/NOPB     |
| 1.8                | LP5990TM-1.8/NOPB       | LP5990TMX-1.8/NOPB     |
| 2.8                | LP5990TM-2.8/NOPB       | LP5990TMX-2.8/NOPB     |
| 3.0                | LP5990TM-3.0/NOPB       | LP5990TMX-3.0/NOPB     |
| 3.3                | LP5990TM-3.3/NOPB       | LP5990TMX-3.3/NOPB     |
| 3.6                | LP5990TM-3.6/NOPB       | LP5990TMX-3.6/NOPB     |

**Absolute Maximum Ratings** (Notes 1, 2)

If Military/Aerospace specified devices are required, please contact the National Semiconductor Sales Office/Distributors for availability and specifications.

|   |   |
|---|---|
| $V_{IN}$ Pin: Input Voltage                   | -0.3 to 6.0V                              |
| $V_{OUT}$ Pin: Output Voltage                 | -0.3 to ( $V_{IN} + 0.3V$ ) to 6.0V (max) |
| $V_{EN}$ Pin: Enable Input Voltage            | -0.3 to 6.0V (max)                        |
| Continuous Power Dissipation (Note 3)         | Internally Limited                        |
| Junction Temperature ( $T_{JMAX}$ )           | 150°C                                     |
| Storage Temperature Range                     | -65 to 150°C                              |
| Maximum Lead Temperature (Soldering, 10 sec.) | 260°C                                     |
| ESD Rating (Note 4)                           |   |

|                  |      |
|------------------|------|
| Human Body Model | 2 kV |
| Machine Model    | 200V |

**Operating Ratings** (Note 1), (Note 2)

|  |                 |
|--|-----------------|
| $V_{IN}$ : Input Voltage Range               | 2.2V to 5.5V    |
| $V_{EN}$ : Enable Voltage Range              | 0 to 5.5V (max) |
| Recommended Load Current (Note 5)            | 0 to 200 mA     |
| Junction Temperature Range ( $T_J$ )         | -40°C to +125°C |
| Ambient Temperature Range ( $T_A$ ) (Note 5) | -40°C to +85°C  |

**Thermal Properties**

|   |           |
|---|-----------|
| Junction to Ambient Thermal Resistance $\theta_{JA}$ (Note 6) |           |
| JEDEC Board (microSMD) (Note 14)                              | 100.6°C/W |
| 4L Cellphone Board (microSMD)                                 | 174.8°C/W |

**Electrical Characteristics**

Limits in standard typeface are for  $T_A = 25^\circ\text{C}$ . Limits in **boldface** type apply over the full operating junction temperature range (-40°C  $\leq T_J \leq +125^\circ\text{C}$ ). Unless otherwise noted, specifications apply to the LP5990 Typical Application Circuit (pg. 1) with:  $V_{IN} = V_{OUT(NOM)} + 1.0V$ , or 2.2V, whichever is higher.  $V_{EN} = 1.0V$ ,  $C_{IN} = C_{OUT} = 1.0 \mu\text{F}$ ,  $I_{OUT} = 1.0 \text{ mA}$ . (Note 2), (Note 7)

| Symbol           | Parameter                              | Conditions   | Min              | Typ  | Max | Units               |
|------------------|--|--|------------------|------|-----|---------------------|
| $V_{IN}$         | Input Voltage                          |  | 2.2              |      | 5.5 | V                   |
| $\Delta V_{OUT}$ | Output Voltage Tolerance               | $V_{IN} = (V_{OUT(NOM)} + 1.0V)$ to 5.5V                             | -1               |      | 1   | %                   |
|                  | Line Regulation                        | $V_{IN} = (V_{OUT(NOM)} + 1.0V)$ to 5.5V, $I_{OUT} = 1 \text{ mA}$   |                  | 1    |     | mV                  |
|                  | Load Regulation                        | $I_{OUT} = 1 \text{ mA}$ to 200 mA                                   |                  | 5    | 15  | mV                  |
| $I_{LOAD}$       | Load Current                           | (Note 8)   | 0                |      |     | mA                  |
|                  | Maximum Output Current                 |  | 200              |      |     |                     |
| $I_Q$            | Quiescent Current (Note 10)            | $V_{EN} = 1.0V$ , $I_{OUT} = 0 \text{ mA}$                           |                  | 30   | 75  | $\mu\text{A}$       |
|                  |  | $V_{EN} = 1.0V$ , $I_{OUT} = 200 \text{ mA}$                         |                  | 35   |     |                     |
|                  |  | $V_{EN} = <0.35V$ (Disabled)   |                  | 0.01 |     |                     |
| $V_{DO}$         | Dropout Voltage (Note 9)               | $I_{OUT} = 200 \text{ mA}$   |                  | 160  | 250 | mV                  |
| $I_{SC}$         | Short Circuit Current Limit            | (Note 11)  |                  | 600  |     | mA                  |
| PSRR             | Power Supply Rejection Ratio (Note 13) | $f = 10 \text{ kHz}$ , $I_{OUT} = 200 \text{ mA}$                    |                  | 55   |     | dB                  |
| $e_n$            | Output Noise Voltage (Note 13)         | BW = 10 Hz to 100 kHz,<br>$V_{IN} = 4.2V$ , $I_{OUT} = 1 \text{ mA}$ | $V_{OUT} = 1.8V$ |      | 60  | $\mu\text{V}_{RMS}$ |
|                  |  |  | $V_{OUT} = 2.8V$ |      | 85  |                     |
| $T_{SHUTDOWN}$   | Thermal Shutdown                       | Temperature  |                  | 160  |     | °C                  |
|                  |  | Hysteresis   |                  | 20   |     |                     |

## Electrical Characteristics (continued).

Limits in standard typeface are for  $T_A = 25^\circ\text{C}$ . Limits in **boldface** type apply over the full operating junction temperature range ( $-40^\circ\text{C} \leq T_J \leq +125^\circ\text{C}$ ). Unless otherwise noted, specifications apply to the LP5990 Typical Application Circuit (pg. 1) with:  $V_{IN} = V_{OUT(NOM)} + 1.0\text{V}$ , or  $2.2\text{V}$ , whichever is higher.  $V_{EN} = 1.0\text{V}$ ,  $C_{IN} = C_{OUT} = 1.0\ \mu\text{F}$ ,  $I_{OUT} = 1.0\ \text{mA}$ . (Note 2), (Note 7)

| Symbol                           | Parameter                                  | Conditions   | Min        | Typ   | Max         | Units         |
|----------------------------------|--|--|------------|-------|-------------|---------------|
| <b>Enable Input Thresholds</b>   |  |  |            |       |             |               |
| $V_{IL}$                         | Low Input Threshold ( $V_{EN}$ )           | $V_{IN} = 2.2\text{V to } 5.5\text{V}$   |            |       | <b>0.35</b> | V             |
| $V_{IH}$                         | High Input Threshold ( $V_{EN}$ )          | $V_{IN} = 2.2\text{V to } 5.5\text{V}$   | <b>1.0</b> |       |             | V             |
| $I_{EN}$                         | Input Current at $V_{EN}$ Pin<br>(Note 12) | $V_{EN} = 5.5\text{V}$ and $V_{IN} = 5.5\text{V}$  |            | 2     | <b>5</b>    | $\mu\text{A}$ |
|                                  |  | $V_{EN} = 0.0\text{V}$ and $V_{IN} = 5.5\text{V}$  |            | 0.001 |             |               |
| <b>Transient Characteristics</b> |  |  |            |       |             |               |
| $\Delta V_{OUT}$                 | Line Transient<br>(Note 13)                | $T_{rise} = T_{fall} = 30\ \mu\text{s}$ . $\Delta V_{IN} = 600\ \text{mV}$   |            | 4     |             | mV            |
|                                  | Load Transient<br>(Note 13)                | $I_{OUT} = 1\ \text{mA to } 200\ \text{mA}$ in $1\ \mu\text{s}$<br>$I_{OUT} = 200\ \text{mA to } 1\ \text{mA}$ in $1\ \mu\text{s}$ |            | -50   |             | mV            |
| $T_{ON}$                         | Turn on Time                               | To 98% of $V_{OUT(NOM)}$   |            | 60    |             | $\mu\text{s}$ |
| $T_{OFF}$                        | Turn off Time from Enable                  | 100mV of $V_{OUT(NOM)}$ $I_{OUT} = 0\text{mA}$   |            | 500   |             | $\mu\text{s}$ |

**Note 1:** Absolute Maximum Ratings indicate limits beyond which damage to the component may occur. Operating Ratings are conditions under which operation of the device is guaranteed. Operating Ratings do not imply guaranteed performance limits. For guaranteed performance limits and associated test conditions, see the Electrical Characteristics tables.

**Note 2:** All voltages are with respect to the potential at the GND pin.

**Note 3:** Internal thermal shutdown circuitry protects the device from permanent damage.

**Note 4:** The Human body model is a  $100\ \text{pF}$  capacitor discharged through a  $1.5\ \text{k}\Omega$  resistor into each pin. The machine model is a  $200\ \text{pF}$  capacitor discharged directly into each pin. MIL-STD-883 3015.7

**Note 5:** In applications where high power dissipation and/or poor package thermal resistance is present, the maximum ambient temperature may have to be derated. Maximum ambient temperature ( $T_{A-MAX}$ ) is dependent on the maximum operating junction temperature ( $T_{J-MAX-OP} = 125^\circ\text{C}$ ), the maximum power dissipation of the device in the application ( $P_{D-MAX}$ ), and the junction-to ambient thermal resistance of the part/package in the application ( $\theta_{JA}$ ), as given by the following equation:  $T_{A-MAX} = T_{J-MAX-OP} - (\theta_{JA} \times P_{D-MAX})$ . See applications section.

**Note 6:** Junction-to-ambient thermal resistance is highly application and board-layout dependent. In applications where high maximum power dissipation exists, special care must be paid to thermal dissipation issues in board design.

**Note 7:** Min and Max limits are guaranteed by design, test, or statistical analysis. Typical numbers are not guaranteed, but do represent the most likely norm.

**Note 8:** The device maintains a stable, regulated output voltage without a load current.

**Note 9:** Dropout voltage is the voltage difference between the input and the output at which the output voltage drops to  $100\ \text{mV}$  below its nominal value. This parameter only applies to output voltages above  $2.8\text{V}$ .

**Note 10:** Quiescent current is defined here as the difference in current between the input voltage source and the load at  $V_{OUT}$ .

**Note 11:** Short Circuit Current is measured with  $V_{OUT}$  pulled to  $0\text{V}$ .

**Note 12:** There is a  $3\ \text{M}\Omega$  resistor between  $V_{EN}$  and ground on the device.

**Note 13:** This specification is guaranteed by design.

**Note 14:** Detailed description of the board can be found in JESD51-7

## Output & Input Capacitor, Recommended Specifications

| Symbol    | Parameter                | Conditions                | Min        | Nom | Max       | Units            |
|-----------|--------------------------|---------------------------|------------|-----|-----------|------------------|
| $C_{IN}$  | Input Capacitance        | Capacitance for stability | <b>0.3</b> | 1.0 |           | $\mu\text{F}$    |
| $C_{OUT}$ | Output Capacitance       |                           | <b>0.3</b> | 1.0 | <b>10</b> |                  |
| ESR       | Output/Input Capacitance |                           | 5          |     | 500       | $\text{m}\Omega$ |

Note: The minimum capacitance should be greater than  $0.3\ \mu\text{F}$  over the full range of operating conditions. The capacitor tolerance should be 30% or better over the full temperature range. The full range of operating conditions for the capacitor in the application should be considered during device selection to ensure this minimum capacitance specification is met. X7R capacitors are recommended however capacitor types X5R, Y5V and Z5U may be used with consideration of the application and conditions.

**Typical Performance Characteristics.** Unless otherwise specified,  $C_{IN} = C_{OUT} = 1.0\mu F$ ,  $V_{IN} = V_{OUT(NOM)} + 1.0V$ ,  $V_{EN} = 1.0V$ ,  $I_{OUT} = 1mA$ ,  $T_A = 25^\circ C$ .

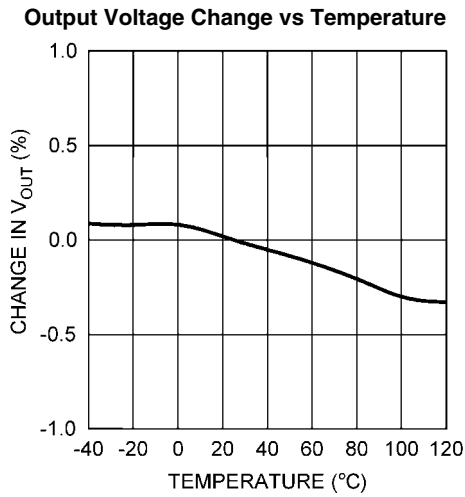

20184899

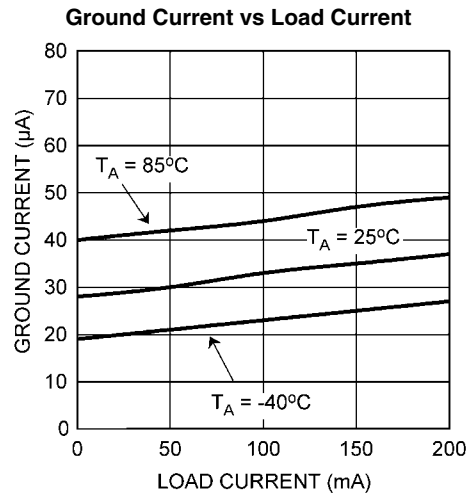

20184843

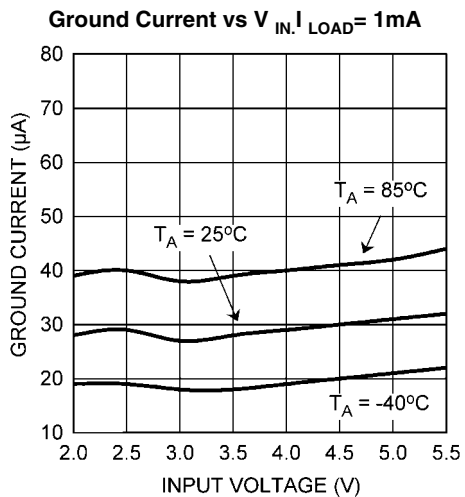

20184854

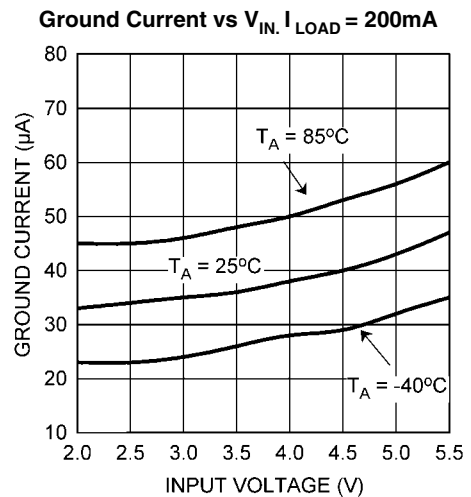

20184851

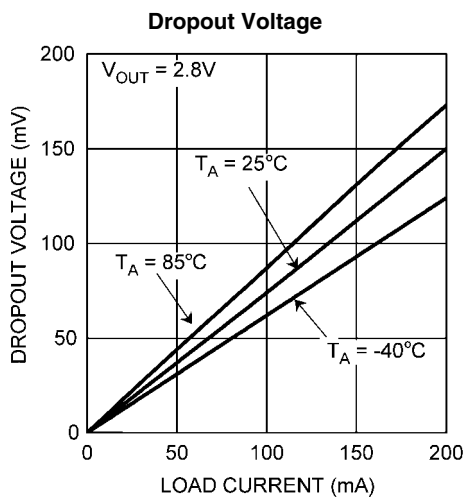

20184889

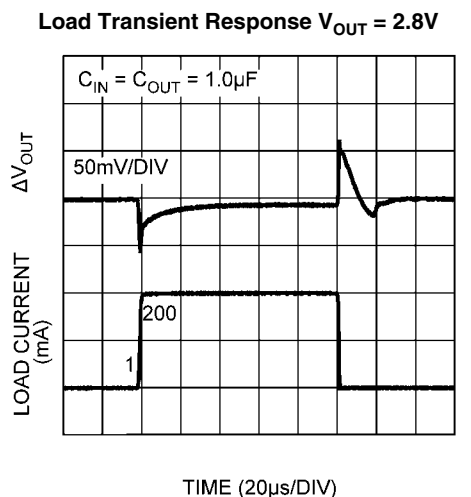

20184887

**Typical Performance Characteristics (continued).** Unless otherwise specified,  $C_{IN} = C_{OUT} = 1.0\mu F$ ,  $V_{IN} = V_{OUT(NOM)} + 1.0V$ ,  $V_{EN} = 1.0V$ ,  $I_{OUT} = 1mA$ ,  $T_A = 25^\circ C$ .

**Load Transient Response.  $V_{OUT} = 2.8V$**

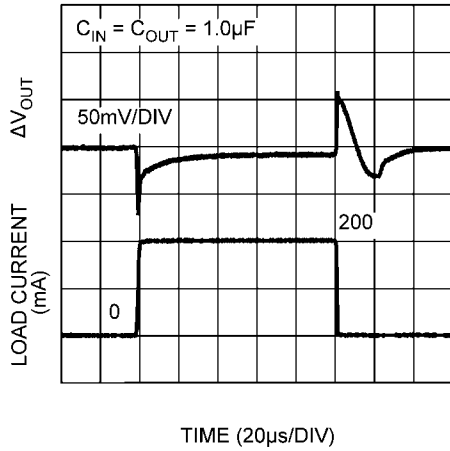

20184886

**Short Circuit Current**

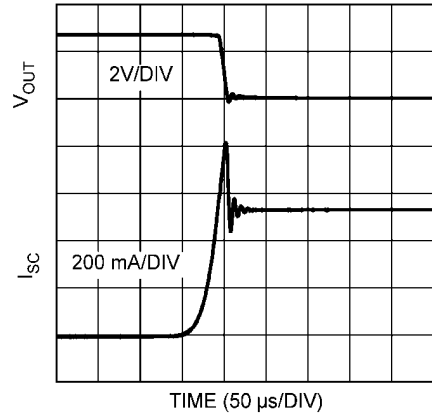

20184888

**Line Transient Response**

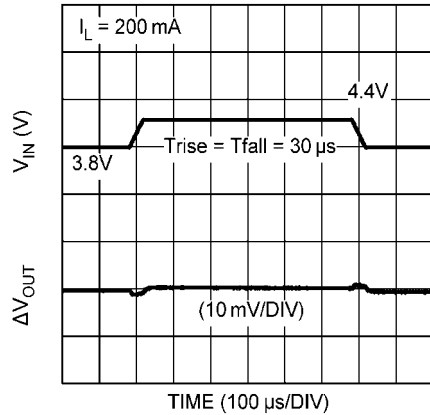

20184895

**Line Transient Response**

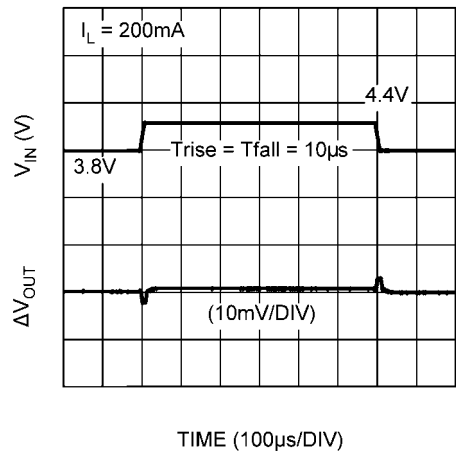

20184885

**Start-up Time**

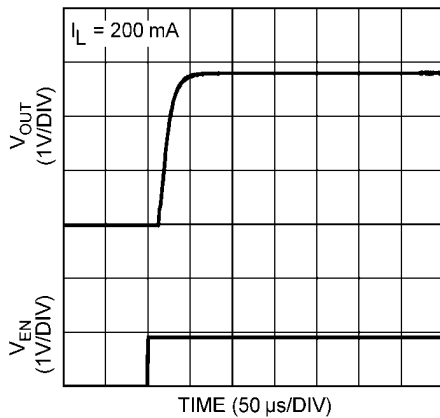

20184893

**Shutdown Characteristics**

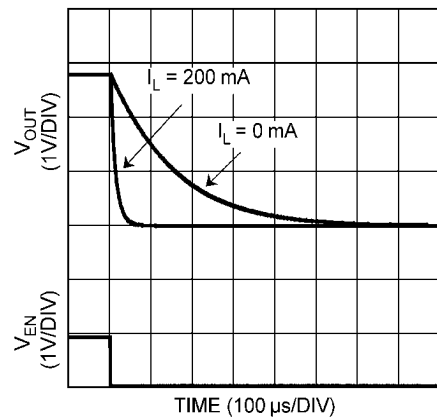

20184890

**Typical Performance Characteristics (continued).** Unless otherwise specified,  $C_{IN} = C_{OUT} = 1.0\mu F$ ,  $V_{IN} = V_{OUT(NOM)} + 1.0V$ ,  $V_{EN} = 1.0V$ ,  $I_{OUT} = 1mA$ ,  $T_A = 25^\circ C$ .

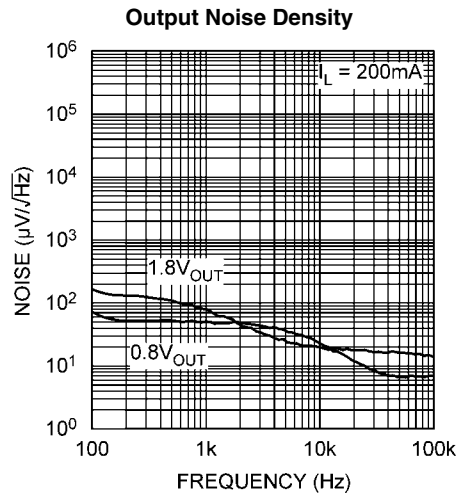
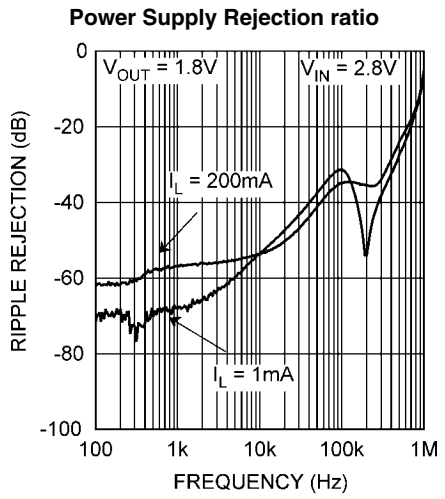

## Application Hints

### POWER DISSIPATION AND DEVICE OPERATION

The permissible power dissipation for any package is a measure of the capability of the device to pass heat from the power source, the junctions of the IC, to the ultimate heat sink, the ambient environment. Thus the power dissipation is dependent on the ambient temperature and the thermal resistance across the various interfaces between the die and ambient air. As stated in (Note 5) of the electrical characteristics, the allowable power dissipation for the device in a given package can be calculated using the equation:

$$P_D = \frac{(T_{JMAX} - T_A)}{\theta_{JA}}$$

The actual power dissipation across the device can be represented by the following equation:

$$P_D = (V_{IN} - V_{OUT}) \times I_{OUT}$$

This establishes the relationship between the power dissipation allowed due to thermal consideration, the voltage drop across the device, and the continuous current capability of the device. These two equations should be used to determine the optimum operating conditions for the device in the application.

### EXTERNAL CAPACITORS

Like any low-dropout regulator, the LP5990 requires external capacitors for regulator stability. The LP5990 is specifically designed for portable applications requiring minimum board space and smallest components. These capacitors must be correctly selected for good performance.

#### INPUT CAPACITOR

An input capacitor is required for stability. The input capacitor should be at least equal to or greater than the output capacitor. It is recommended that a 1.0  $\mu\text{F}$  capacitor be connected between the LP5990 input pin and ground.

This capacitor must be located a distance of not more than 1 cm from the input pin and returned to a clean analogue ground. Any good quality ceramic, tantalum, or film capacitor may be used at the input.

**Important:** To ensure stable operation it is essential that good PCB practices are employed to minimize ground impedance and keep input inductance low. If these conditions cannot be met, or if long leads are to be used to connect the battery or other power source to the LP5990, then it is recommended to increase the input capacitor to at least 2.2  $\mu\text{F}$ . Also, tantalum capacitors can suffer catastrophic failures due to surge current when connected to a low-impedance source of power (like a battery or a very large capacitor). If a tantalum capacitor is used at the input, it must be guaranteed by the manufacturer to have a surge current rating sufficient for the application. There are no requirements for the ESR (Equivalent Series Resistance) on the input capacitor, but tolerance and temperature coefficient must be considered when selecting the capacitor to ensure the capacitance will remain 0.3  $\mu\text{F}$  over the entire operating temperature range.

#### OUTPUT CAPACITOR

The LP5990 is designed specifically to work with very small ceramic output capacitors. A ceramic capacitor (dielectric types X5R or X7R) 1.0  $\mu\text{F}$ , and with ESR between 5 m $\Omega$  to 500 m $\Omega$ , is suitable in the LP5990 application circuit.

Other ceramic capacitors such as Y5V and Z5U are less suitable owing to their inferior temperature characteristics. (See section in Capacitor Characteristics).

For this device the output capacitor should be connected between the  $V_{OUT}$  pin and a good ground connection and should be mounted within 1 cm of the device.

It may also be possible to use tantalum or film capacitors at the device output,  $V_{OUT}$ , but these are not as attractive for reasons of size and cost (see the section Capacitor Characteristics).

The output capacitor must meet the requirement for the minimum value of capacitance (0.3  $\mu\text{F}$ ) and have an ESR value that is within the range 5 m $\Omega$  to 500 m $\Omega$  for stability.

### CAPACITOR CHARACTERISTICS

The LP5990 is designed to work with ceramic capacitors on the input and output to take advantage of the benefits they offer. For capacitance values in the range of 1.0  $\mu\text{F}$  to 4.7  $\mu\text{F}$ , ceramic capacitors are the smallest, least expensive and have the lowest ESR values, thus making them best for eliminating high frequency noise. The ESR of a typical 1.0  $\mu\text{F}$  ceramic capacitor is in the range of 20 m $\Omega$  to 40 m $\Omega$ , which easily meets the ESR requirement for stability for the LP5990. For both input and output capacitors careful interpretation of the capacitor specification is required to ensure correct device operation. The capacitor value can change greatly depending on the conditions of operation and capacitor type.

In particular the output capacitor selection should take account of all the capacitor parameters to ensure that the specification is met within the application. Capacitance value can vary with DC bias conditions as well as temperature and frequency of operation. Capacitor values will also show some decrease over time due to aging. The capacitor parameters are also dependant on particular case size with smaller sizes giving poorer performance figures in general. As an example *Figure 1* shows a typical graph showing a comparison of capacitor case sizes in a Capacitance versus DC Bias plot. As shown in the graph, as a result of the DC Bias condition, the capacitance value may drop below the minimum capacitance value given in the recommended capacitor table (0.3  $\mu\text{F}$  in this case). Note that the graph shows the capacitance out of spec for the 0402 case size capacitor at higher bias voltages. It is therefore recommend that the capacitor manufacturer's specifications for the nominal value capacitor are consulted for all conditions as some capacitors may not be suited in the application.

The temperature performance of ceramic capacitors varies by type and manufacturer. Most large value ceramic capacitors ( $\geq 2.2 \mu\text{F}$ ) are manufactured with Z5U or Y5V temperature characteristics, which results in the capacitance dropping by more than 50% as the temperature goes from 25°C to 85°C. A better choice for temperature coefficient in a ceramic capacitor is X7R. This type of capacitor is the most stable and holds the capacitance within  $\pm 15\%$  over the temperature range. Tantalum capacitors are less desirable than ceramic for use as output capacitors because they are more expensive when comparing equivalent capacitance and voltage ratings in the 0.47  $\mu\text{F}$  to 4.7  $\mu\text{F}$  range.

Another important consideration is that tantalum capacitors have higher ESR values than equivalent size ceramics. This means that while it may be possible to find a tantalum capacitor with an ESR value within the stable range, it would have to be larger in capacitance (which means bigger and more costly) than a ceramic capacitor with the same ESR value. It should also be noted that the ESR of a typical tantalum will



increase about 2:1 as the temperature goes from 25°C down to -40°C, so some guard band must be allowed.

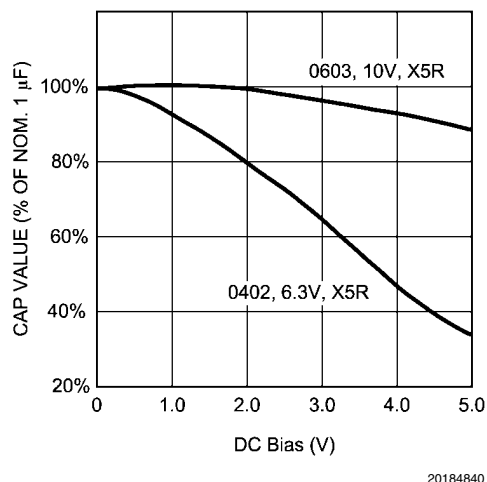

**FIGURE 1. Graph Showing a Typical Variation in Capacitance vs DC Bias**

#### NO-LOAD STABILITY

The LP5990 will remain stable and in regulation with no external load.

#### ENABLE CONTROL

The LP5990 may be switched ON or OFF by a logic input at the ENABLE pin,  $V_{EN}$ . A high voltage at this pin will turn the

device on. When the enable pin is low, the regulator output is off and the device typically consumes 3 nA. If the application does not require the shutdown feature, the  $V_{EN}$  pin should be tied to  $V_{IN}$  to keep the regulator output permanently on.

The signal source used to drive the  $V_{EN}$  input must be able to swing above and below the specified turn-on/off voltage thresholds listed in the Electrical Characteristics section under  $V_{IL}$  and  $V_{IH}$ .

#### micro SMD MOUNTING

The micro SMD package requires specific mounting techniques, which are detailed in National Semiconductor Application Note AN-1112.

For best results during assembly, alignment ordinals on the PC board may be used to facilitate placement of the micro SMD device.

#### micro SMD LIGHT SENSITIVITY

Exposing the micro SMD device to direct light may cause incorrect operation of the device. Light sources such as halogen lamps can affect electrical performance if they are situated in proximity to the device.

Light with wavelengths in the red and infra-red part of the spectrum have the most detrimental effect thus the fluorescent lighting used inside most buildings has very little effect on performance.

**Physical Dimensions** inches (millimeters) unless otherwise noted

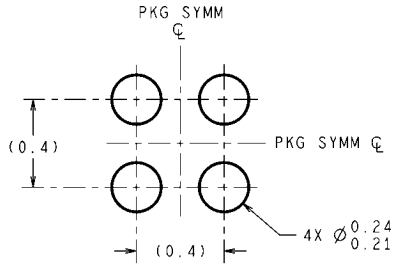

**DIMENSIONS ARE IN MILLIMETERS**  
DIMENSIONS IN ( ) FOR REFERENCE ONLY

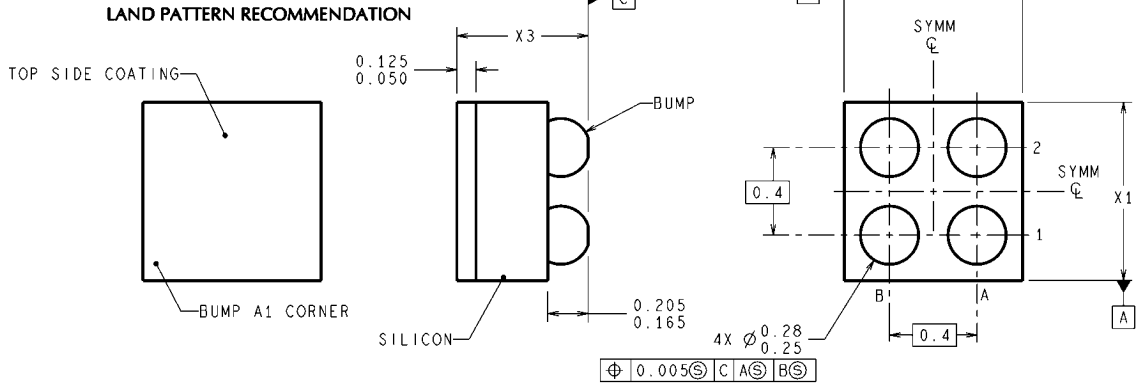

TMD04XXX (Rev A)

**4-Bump Thin micro SMD**  
**NS Package Number TMD04 CEA**  
**The dimensions for X1, X2 and X3 are given as:**  
**X1 = 0.866 mm ± 0.030 mm**  
**X2 = 0.917 mm ± 0.030 mm**  
**X3 = 0.600 mm ± 0.075 mm**

# Notes

LP5990

## Notes

For more National Semiconductor product information and proven design tools, visit the following Web sites at:

| Products                       |  | Design Support          |  |
|--------------------------------|--|-------------------------|--|
| Amplifiers                     | <a href="http://www.national.com/amplifiers">www.national.com/amplifiers</a>   | WEBENCH                 | <a href="http://www.national.com/webench">www.national.com/webench</a>             |
| Audio                          | <a href="http://www.national.com/audio">www.national.com/audio</a>             | Analog University       | <a href="http://www.national.com/AU">www.national.com/AU</a>                       |
| Clock Conditioners             | <a href="http://www.national.com/timing">www.national.com/timing</a>           | App Notes               | <a href="http://www.national.com/appnotes">www.national.com/appnotes</a>           |
| Data Converters                | <a href="http://www.national.com/adc">www.national.com/adc</a>                 | Distributors            | <a href="http://www.national.com/contacts">www.national.com/contacts</a>           |
| Displays                       | <a href="http://www.national.com/displays">www.national.com/displays</a>       | Green Compliance        | <a href="http://www.national.com/quality/green">www.national.com/quality/green</a> |
| Ethernet                       | <a href="http://www.national.com/ethernet">www.national.com/ethernet</a>       | Packaging               | <a href="http://www.national.com/packaging">www.national.com/packaging</a>         |
| Interface                      | <a href="http://www.national.com/interface">www.national.com/interface</a>     | Quality and Reliability | <a href="http://www.national.com/quality">www.national.com/quality</a>             |
| LVDS                           | <a href="http://www.national.com/lvds">www.national.com/lvds</a>               | Reference Designs       | <a href="http://www.national.com/refdesigns">www.national.com/refdesigns</a>       |
| Power Management               | <a href="http://www.national.com/power">www.national.com/power</a>             | Feedback                | <a href="http://www.national.com/feedback">www.national.com/feedback</a>           |
| Switching Regulators           | <a href="http://www.national.com/switchers">www.national.com/switchers</a>     |                         |  |
| LDOs                           | <a href="http://www.national.com/ldo">www.national.com/ldo</a>                 |                         |  |
| LED Lighting                   | <a href="http://www.national.com/led">www.national.com/led</a>                 |                         |  |
| PowerWise                      | <a href="http://www.national.com/powerwise">www.national.com/powerwise</a>     |                         |  |
| Serial Digital Interface (SDI) | <a href="http://www.national.com/sdi">www.national.com/sdi</a>                 |                         |  |
| Temperature Sensors            | <a href="http://www.national.com/tempsensors">www.national.com/tempsensors</a> |                         |  |
| Wireless (PLL/VCO)             | <a href="http://www.national.com/wireless">www.national.com/wireless</a>       |                         |  |

THE CONTENTS OF THIS DOCUMENT ARE PROVIDED IN CONNECTION WITH NATIONAL SEMICONDUCTOR CORPORATION ("NATIONAL") PRODUCTS. NATIONAL MAKES NO REPRESENTATIONS OR WARRANTIES WITH RESPECT TO THE ACCURACY OR COMPLETENESS OF THE CONTENTS OF THIS PUBLICATION AND RESERVES THE RIGHT TO MAKE CHANGES TO SPECIFICATIONS AND PRODUCT DESCRIPTIONS AT ANY TIME WITHOUT NOTICE. NO LICENSE, WHETHER EXPRESS, IMPLIED, ARISING BY ESTOPPEL OR OTHERWISE, TO ANY INTELLECTUAL PROPERTY RIGHTS IS GRANTED BY THIS DOCUMENT.

TESTING AND OTHER QUALITY CONTROLS ARE USED TO THE EXTENT NATIONAL DEEMS NECESSARY TO SUPPORT NATIONAL'S PRODUCT WARRANTY. EXCEPT WHERE MANDATED BY GOVERNMENT REQUIREMENTS, TESTING OF ALL PARAMETERS OF EACH PRODUCT IS NOT NECESSARILY PERFORMED. NATIONAL ASSUMES NO LIABILITY FOR APPLICATIONS ASSISTANCE OR BUYER PRODUCT DESIGN. BUYERS ARE RESPONSIBLE FOR THEIR PRODUCTS AND APPLICATIONS USING NATIONAL COMPONENTS. PRIOR TO USING OR DISTRIBUTING ANY PRODUCTS THAT INCLUDE NATIONAL COMPONENTS, BUYERS SHOULD PROVIDE ADEQUATE DESIGN, TESTING AND OPERATING SAFEGUARDS.

EXCEPT AS PROVIDED IN NATIONAL'S TERMS AND CONDITIONS OF SALE FOR SUCH PRODUCTS, NATIONAL ASSUMES NO LIABILITY WHATSOEVER, AND NATIONAL DISCLAIMS ANY EXPRESS OR IMPLIED WARRANTY RELATING TO THE SALE AND/OR USE OF NATIONAL PRODUCTS INCLUDING LIABILITY OR WARRANTIES RELATING TO FITNESS FOR A PARTICULAR PURPOSE, MERCHANTABILITY, OR INFRINGEMENT OF ANY PATENT, COPYRIGHT OR OTHER INTELLECTUAL PROPERTY RIGHT.

### LIFE SUPPORT POLICY

**NATIONAL'S PRODUCTS ARE NOT AUTHORIZED FOR USE AS CRITICAL COMPONENTS IN LIFE SUPPORT DEVICES OR SYSTEMS WITHOUT THE EXPRESS PRIOR WRITTEN APPROVAL OF THE CHIEF EXECUTIVE OFFICER AND GENERAL COUNSEL OF NATIONAL SEMICONDUCTOR CORPORATION.** As used herein:

Life support devices or systems are devices which (a) are intended for surgical implant into the body, or (b) support or sustain life and whose failure to perform when properly used in accordance with instructions for use provided in the labeling can be reasonably expected to result in a significant injury to the user. A critical component is any component in a life support device or system whose failure to perform can be reasonably expected to cause the failure of the life support device or system or to affect its safety or effectiveness.

National Semiconductor and the National Semiconductor logo are registered trademarks of National Semiconductor Corporation. All other brand or product names may be trademarks or registered trademarks of their respective holders.

Copyright© 2007 National Semiconductor Corporation

For the most current product information visit us at [www.national.com](http://www.national.com)



**National Semiconductor Americas Customer Support Center**  
 Email: [new.feedback@nsc.com](mailto:new.feedback@nsc.com)  
 Tel: 1-800-272-9959

**National Semiconductor Europe Customer Support Center**  
 Fax: +49 (0) 180-530-85-86  
 Email: [europe.support@nsc.com](mailto:europe.support@nsc.com)  
 Deutsch Tel: +49 (0) 69 9508 6208  
 English Tel: +49 (0) 870 24 0 2171  
 Français Tel: +33 (0) 1 41 91 8790

**National Semiconductor Asia Pacific Customer Support Center**  
 Email: [ap.support@nsc.com](mailto:ap.support@nsc.com)

**National Semiconductor Japan Customer Support Center**  
 Fax: 81-3-5639-7507  
 Email: [jpn.feedback@nsc.com](mailto:jpn.feedback@nsc.com)  
 Tel: 81-3-5639-7560