

Surface Mount Multilayer Ceramic Chip Capacitors for Automotive Applications



For more than 20 years Vishay Vitramon has supported the Automotive Industry with robust, highly reliable MLCCs that have made it a leader in this segment. All Vishay Vitramon MLCCs are manufactured in "Precious Metal Technology" (PMT/NME) with a wet build process. They are qualified according to AEC Q-200 with PPAP available on request. Applications for these devices include automotive "under the hood", safety and comfort electronics. Their termination finish is 100 % tin plate matte and AgPd which is used with silver epoxy bonding. A Polymer (flexible) termination with 100 % tin plate matte finish is under full qualification and expected to be released early 2008.

COG (NP0) DIELECTRIC	X7R DIELECTRIC
<p>GENERAL SPECIFICATIONS Note: Electrical characteristics at + 25 °C unless otherwise specified</p> <p>Operating Temperature: - 55 °C to + 150 °C (above + 125 °C characteristics 2.3)</p> <p>Temperature Coefficient of Capacitance (TCC): ± 30 ppm/°C from - 55 °C to + 125 °</p> <p>Dissipation Factor (DF): 0.1 % maximum at 1.0 V_{rms} and 1 kHz for values > 1000 pF 0.1 % maximum at 1.0 V_{rms} and 1 MHz for values > 1000 pF</p> <p>Voltage Range: 25 Vdc to 3000 Vdc</p> <p>Insulating Resistance: At + 25 °C 100 000 MΩ min or 1000 ΩF whichever is less At + 125 °C 10 000 MΩ min or 100 ΩF whichever is less</p> <p>Aging: 0 % maximum per decade</p> <p>Dielectric Withstanding Voltage (DWV): This is the maximum voltage the capacitors are tested for a 1 to 5 second period and the charge/discharge current does not exceed 50 mA ≤ 200 Vdc: DWV at 250 % of rated voltage 500 Vdc: DWV at 200 % of rated voltage 630 Vdc/1000 Vdc: DWV at 150 % of rated voltage 3000 Vdc: DWV at 120 % of rated voltage</p>	<p>GENERAL SPECIFICATIONS Note: Electrical characteristics at + 25 °C unless otherwise specified</p> <p>Operating Temperature: - 55 °C to + 150 °C (above + 125 °C characteristics 2.3)</p> <p>Capacitance Range: 100 pF to 1.0 μF</p> <p>Temperature Coefficient of Capacitance (TCC): X7R: ± 15 % from - 55 °C to 125 °C, with 0 Vdc applied X5R: ± 15 % from - 55 °C to 85 °C, with 0 Vdc applied ⁽⁵⁾</p> <p>Dissipation Factor (DF): ≤ 25 V ratings: 3.5 % maximum at 1.0 V_{rms} and 1 kHz ≤ 25 V ratings: 2.5 % maximum at 1.0 V_{rms} and 1 kHz</p> <p>Aging Rate: 1 % maximum per decade</p> <p>Voltage Range: 10 Vdc to 1000 Vdc</p> <p>Insulating Resistance: At + 25 °C 100 000 MΩ min. or 1000 ΩF whichever is less At + 125 °C 10 000 MΩ min. or 100 ΩF whichever is less</p> <p>Dielectric Withstanding Voltage (DWV): This is the maximum voltage the capacitors are tested for a 1 to 5 s period and the charge/discharge current does not exceed 50 mA ≤ 200 Vdc: DWV at 250 % of rated voltage 500 Vdc: DWV at 200 % of rated voltage 630 Vdc/1000 Vdc: DWV at 150 % of rated voltage</p>



VJ....31/VJ....34 Automotive MLCC

Surface Mount Multilayer Ceramic Chip Capacitors Vishay Vitramon
for Automotive Applications

PART DESCRIPTION								
VJ0805 ⁽²⁾	Y	102	K	X	A	A	C	31
CASE CODE	DIELECTRIC	CAPACITANCE NOMINAL CODE	CAPACITANCE TOLERANCE	TERMINATION	DC VOLTAGE RATING ⁽¹⁾	MARKING	PACKAGING	PROCESS CODE
0402 0603 0805 1206 1210 1812	A = NP0 (C0G) Y = X7R G = X5R ⁽⁵⁾	Expressed in picofarads (pF). The first two digits are significant, the third is a multiplier. An "R" indicates a decimal point. Examples: 4R7 = 4.7 pF 102 = 1000 pF	B = ± 0.10 pF C = ± 0.25 pF D = ± 0.5 pF F = ± 1 % G = ± 2 % J = ± 5 % K = ± 10 % M = ± 20 % Note: NP0 (C0G): B, C, D < 10 pF F, G, J ≥ 10 pF X7R: J, K, M	X = Ni barrier 100 % tin plate matte finish B = Polymer 100 % tin plate matte finish ⁽³⁾	Q = 10 V J = 16 V X = 25 V A = 50 V B = 100 V C = 200 V P = 250 V T = 400V E = 500 V L = 630 V G = 1000 V H = 3000 V	A = Unmarked B = Marked Note: Marking is only available for 0805 and 1206 vendor ID and date code E = 7" reel/plastic tape C = 7" reel/paper tape M = 11 1/4"/13" reel/plastic tape P = 11 1/4"/13" reel/paper tape		31 = Automotive 100 % tin plate matte finish

PART DESCRIPTION								
VJ0805 ⁽²⁾	Y	102	K	F	A	A	T	34
CASE CODE	DIELECTRIC	CAPACITANCE NOMINAL CODE	CAPACITANCE TOLERANCE	TERMINATION	DC VOLTAGE RATING ⁽¹⁾	MARKING	PACKAGING	PROCESS CODE
0402 0603 0805 1206 1210 1812	A = NP0 (C0G) Y = X7R G = X5R ⁽⁵⁾	Expressed in picofarads (pF). The first two digits are significant, the third is a multiplier. An "R" indicates a decimal point. Examples: 102 = 1000 pF	B = ± 0.10 pF C = ± 0.25 pF D = ± 0.5 pF F = ± 1 % G = ± 2 % J = ± 5 % K = ± 10 % M = ± 20 % Note: NP0 (C0G) B, C, D < 10 pF F, G, J, ≥ 10 pF X7R: J, K, M	F = AgPd	Q = 10 V J = 16 V X = 25 V A = 50 V B = 100 V C = 200 V P = 250 V ⁽⁴⁾ T = 400 V ⁽⁴⁾ E = 500 V L = 630 V G = 1000 V H = 3000 V	A = Unmarked Note: Marking is not available		34 = Automotive AgPd finish

Notes:

- (1) DC voltage rating should not be exceeded in application
- (2) Case size designator may be replaced by a four digit drawing number
- (3) Polymer termination under qualification. Expected 2008
- (4) Per customer request. Contact: mlcc@vishay.com for availability
- (5) Selected values for X5R, see dielectric selection chart

VJ....31/VJ....34 Automotive MLCC



Vishay Vitramon Surface Mount Multilayer Ceramic Chip Capacitors
for Automotive Applications

COG (NP0) DIELECTRIC																										
STYLE		VJ0402			VJ0603			VJ0805				VJ1206				VJ1210 (1)				VJ1812 (1) (2)						
EIA TYPE		0402			0603			0805				1206				1210				1812						
VOLTAGE (Vdc)		25	50	100	50	100	200	50	100	200	500	50	100	200	500/630	50	100	200	500/630	50	100	200	500/630	1000	3000	
CAP. CODE	CAP.																									
1R0	1.0 pF	**	**	**	**	**	**	**	**	**	**	*	*	*	*											
1R2	1.2 pF	**	**	**	**	**	**	**	**	**	**	*	*	*	*											
1R5	1.5 pF	**	**	**	**	**	**	**	**	**	**	*	*	*	*											
1R8	1.8 pF	**	**	**	**	**	**	**	**	**	**	*	*	*	*											
2R2	2.2 pF	**	**	**	**	**	**	**	**	**	**	*	*	*	*											
2R7	2.7 pF	**	**	**	**	**	**	**	**	**	**	*	*	*	*											
3R3	3.3 pF	**	**	**	**	**	**	**	**	**	**	*	*	*	*											
3R9	3.9 pF	**	**	**	**	**	**	**	**	**	**	*	*	*	*											
4R7	4.7 pF	**	**	**	**	**	**	**	**	**	**	*	*	*	*											
5R6	5.6 pF	**	**	**	**	**	**	**	**	**	**	*	*	*	*											
6R8	6.8 pF	**	**	**	**	**	**	**	**	**	**	*	*	*	*											
8R2	8.2 pF	**	**	**	**	**	**	**	**	**	**	*	*	*	*											
100	10 pF	**	**	**	**	**	**	**	**	**	**	*	*	*	*											
120	12 pF	**	**	**	**	**	**	**	**	**	**	*	*	*	*										*	
150	15 pF	**	**	**	**	**	**	**	**	**	**	*	*	*	*										*	
180	18 pF	**	**	**	**	**	**	**	**	**	**	*	*	*	*										*	
220	22 pF	++	++	++	**	**	**	**	**	**	**	*	*	*	*										*	
270	27 pF	++	++	++	**	**	**	**	**	**	**	*	*	*	*										*	
330	33 pF	++	++	++	**	**	**	**	**	**	**	*	*	*	*										*	
390	39 pF	++	++	++	**	**	**	**	**	**	**	*	*	*	*					*	*	*	*	*	*	
470	47 pF	++	++	++	**	**	**	**	**	**	**	*	*	*	*					*	*	*	*	*	*	
560	56 pF	++	++	++	++	++	++	**	**	**	**	*	*	*	*					*	*	*	*	*	*	
680	68 pF	++	++	++	++	++	++	**	**	**	**	*	*	*	*					*	*	*	*	*	*	
820	82 pF	++	++	++	++	++	++	**	**	**	**	*	*	*	*					*	*	*	*	*	*	
101	100 pF	++	++	++	++	++	++	++	++	++	++	+	+	+	+	+	+	+	+	*	*	*	*	*	*	
121	120 pF	++	++	++	++	++	++	++	++	++	++	+	+	+	+	+	+	+	+	*	*	*	*	*	*	
151	150 pF	++	++		++	++	++	++	++	++	++	+	+	+	+	+	+	+	+	*	*	*	*	*	*	
181	180 pF	++	++		++	++	+	++	++	++	++	+	+	+	+	+	+	+	+	*	*	*	*	*	*	
221	220 pF				++	++	+	++	++	++	++	+	+	+	+	+	+	+	+	*	*	*	*	*	*	
271	270 pF				++	++	+	++	++	++	++	+	+	+	+	+	+	+	+	*	*	*	*	*	*	
331	330 pF				++	++		++	++	++	++	+	+	+	+	+	+	+	+	*	*	*	*	*	*	
391	390 pF				++	++		++	++	++	++	+	+	+	+	+	+	+	+	*	*	*	*	*	*	
471	470 pF				++			++	++	++	++	+	+	+	+	+	+	+	+	*	*	*	*	*	*	
561	560 pF				++			++	++	++	++	+	+	+	+	+	+	+	+	*	*	*	*	*	*	
681	680 pF				++			++	++	++	++	+	+	+	+	+	+	+	+	*	*	*	*	*	*	
821	820 pF				++			++	++	++	++	+	+	+	+	+	+	+	+	*	*	*	*	*	*	
102	1000 pF							++	++	++	++	+	+	+	+	+	+	+	+	*	*	*	*	*	*	
122	1200 pF							++	+			+	+	+		+	+	+	+	*	*	*	*	*	*	
152	1500 pF							++	+			+	+	+		+	+	+	+	*	*	*	*	*	*	
182	1800 pF							+	+			+	+	+		+	+	+	+	*	*	*	*	*	*	
222	2200 pF							+				+	+	+		+	+	+	+	*	*	*	*	*	*	
272	2700 pF							+				+	+	+		+	+	+	+	*	*	*	*	*	*	
332	3300 pF							+				+	+	+		+	+	+	+	*	*	*	*	*	*	
392	3900 pF							+				+	+			+	+	+	+	*	*	*	*	*	*	
472	4700 pF											+	+			+	+	+	+	*	*	*	*	*	*	
562	5600 pF											+	+			+	+	+	+	*	*	*	*	*	*	
682	6800 pF											+	+			+	+	+	+	*	*	*	*	*	*	
822	8200 pF											+	+			+	+	+	+	*	*	*	*	*	*	
103	0.010 µF											+	+			+	+	+	+	*	*	*	*	*	*	
123	0.012 µF															+	+	+	+	*	*	*	*	*	*	
153	0.015 µF															+	+			*	*	*	*	*	*	
183	0.018 µF															+	+			*	*	*	*	*	*	
223	0.022 µF															+	+			*	*	*	*	*	*	
273	0.027 µF																			*	*	*	*	*	*	
333	0.033 µF																									
393	0.039 µF																									
473	0.047 µF																									
563	0.056 µF																									

Notes:
 ** Paper tape, * Plastic tape, ++ Paper tape, + Plastic tape, see table "Product drawings (in use)"
 (1) See soldering recommendations
 (2) 1812 - 1000 V/3000 V, please contact for availability: mlcc@vishay.com

VJ....31/VJ....34 Automotive MLCC



Vishay Vitramon Surface Mount Multilayer Ceramic Chip Capacitors
for Automotive Applications

PRODUCT DRAWINGS (in use)					
		X-TERMINATION CODE (100 % MATTE TIN)		F - TERMINATION CODE (AgPd)	
SIZE	CODE	DRAWING NP0	DRAWING X7R	DRAWING NP0	DRAWING X7R
0402	•• = Papertape	7175	9172	7175	9072
	++ = Papertape	7172	7172	7072	7072
0603	•• = Papertape	7179	9155	7179	9097
	++ = Papertape	7155	7155	7097	7097
	• = Plastictape	7179	9155	7179	9097
	+ = Plastictape	7155	7155	7097	7097
0805	•• = Papertape	7188	9156	7188	9080
	++ = Papertape	7156	7156	7080	7080
	• = Plastictape	7188	9156	7188	9080
	+ = Plastictape	7156	7156	7080	7080
1206	• = Plastictape	7180	9157	7180	9081
	+ = Plastictape	7157	7157	7081	7081
1210	• = Plastictape	7190	9158	7190	9099
	+ = Plastictape	7158	7158	7099	7099
1812 ⁽⁶⁾	• = Plastictape	7159/7979	7159/9979	7082/7979/9979	9082/7979/9979
	+ = Plastictape	7159/7979	7159/9159 7979/9979	7082/7979/9979	7082/9082 7979/9979

STANDARD PACKAGING QUANTITIES (1) (2)					
		7" REEL QUANTITIES		11 1/4" AND 13" REEL QUANTITIES	
BODY SIZE	TAPE SIZE	PAPER TAPE PACKAGING CODE "C"/"O" (4)	PLASTIC TAPE PACKAGING CODE "E"	PAPER TAPE PACKAGING CODE "P"/"I" (4)	PLASTIC TAPE PACKAGING CODE "M"
0402	8 mm	5000/10 000	N/a	10 000/30 000 ⁽³⁾	N/a
0603	8 mm	4000	N/a	10 000	N/a
0805 ⁽⁵⁾	8 mm	3000	3000	10 000	10 000
1206 ⁽⁵⁾	8 mm	N/a	3000	N/a	10 000
1210 ⁽⁵⁾	8 mm	N/a	3000	N/a	10 000
1812	12 mm	N/a	1000	N/a	5000

Notes:

- (1) REFERENCE: EIA Standard RS 481 – "Taping of Surface Mount Components for Automatic Placement"
- (2) N/a = Not available
- (3) Quantity can vary with customer request
- (4) Flamed paper tape code "O" (7" reel) and "I" (11 1/4/13" reel) for AgPd terminated parts (termination code F)
- (5) Packaging "C/P" or "E/M" and quantity can depend from product thickness
- (6) Drawing 7159/9159 per customer request. Please contact: mlcc@vishay.com



VJ....31/VJ....34 Automotive MLCC

Surface Mount Multilayer Ceramic Chip Capacitors Vishay Vitramon
for Automotive Applications

1 - GENERAL CERTIFICATES

# Quality Management System acc. to ISO/TS 16949 certified	Yes
# Quality Management System acc. to ISO9000, Rev. 2000 certified	Yes
# Environmental Certification acc. to ISO 14001	Yes

2 - TECHNICAL REQUIREMENTS

Unless specified in component specification, these parameters are the minimum requirements for the components.

2.1 - OPERATING TEMPERATURE RANGE

For standard applications	T _A : - 55 °C to + 125 °C	see characteristics 2.3
For high temperature applications	T _A : - 55 °C to + 150 °C	see characteristics 2.3
For ultra high temperature applications	T _A : - 55 °C to + 175 °C	see characteristics 2.3

2.2 - STORAGE TEMPERATURE RANGE

Comment: Only for the part without packaging	T _A : - 55 °C to + 150 °C
--	--------------------------------------

2.3 - CHARACTERISTICS

PARAMETER	CERAMIC TYPE	SYMBOL	RATINGS	TEST CONDITIONS/REMARKS
Rated voltage in temperature range - 55 °C to + 125 °C	NP0 (C0G), X7R	U _R	10 V - 500 V	
Derating at higher temperature	NP0 (C0G), X7R	N/a	10 V - 100 V	+ 150 °C U ≤ ½ UR + 175 °C U ≤ ¼ UR
Temperature coefficient in temperature range - 55 °C to + 125 °C	NP0 (C0G), X7R	α _C ΔC	≤ ± 30 ppm/K ≤ ± 15 %	if C _R < 10 pF: α _C ≤ ± 120 ppm/K
Temperature coefficient in temperature range - 55 °C to + 150 °C For typical data see graphs below	NP0 (C0G), X7R	α _C ΔC	≤ ± 30 ppm/K + 15/- 30 % + 15/- 50 %	- 55 °C to + 150 °C - 55 °C to + 150 °C - 55 °C to + 175 °C
Dissipation factor in temperature range - 55 °C to + 175 °C	NP0 (C0G), X7R	tan δ	≤ 0.0015 tan δ ≤ 0.06	

2.3.1 - C0G (NP0) DIELECTRIC - TYPICAL PARAMETERS

TYPICAL PARAMETER NP0 (C0G)
TEMPERATURE DEPENDENCE OF CAPACITANCE

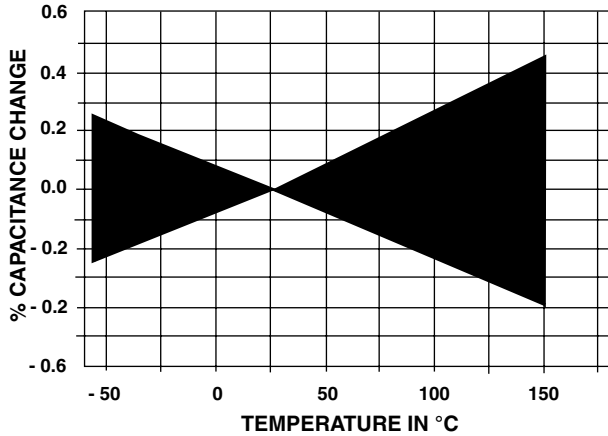

TYPICAL PARAMETER C0G (NP0)
VOLTAGE COEFFICIENT OF CAPACITANCE - NP0

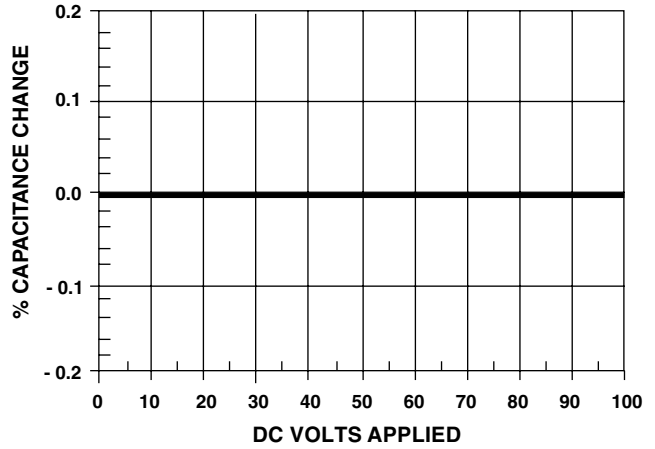

TYPICAL PARAMETER C0G (NP0)
AGING RATE - NP0

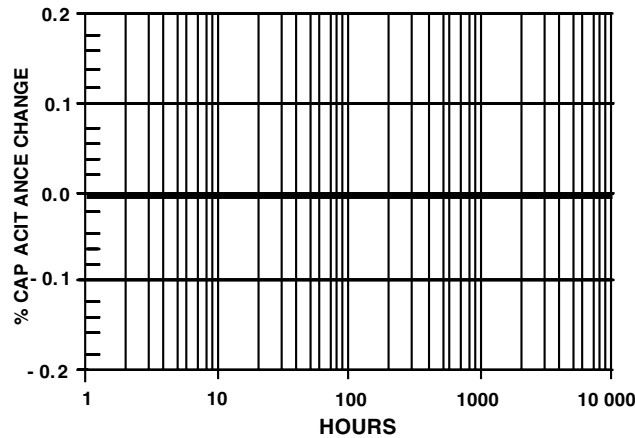

TYPICAL PARAMETER C0G (NP0)
ISOLATION RESISTANCE

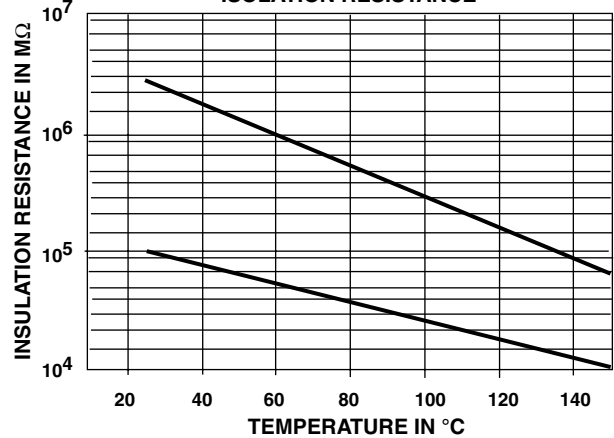

TYPICAL PARAMETER C0G (NP0)
CHANGE OF CAPACITANCE WITH FREQUENCY - NP0

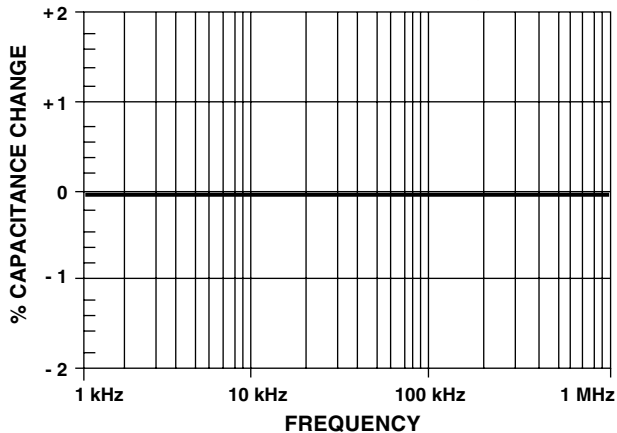

TYPICAL PARAMETER C0G (NP0)
CHANGE OF CAPACITANCE WITH FREQUENCY - NP0

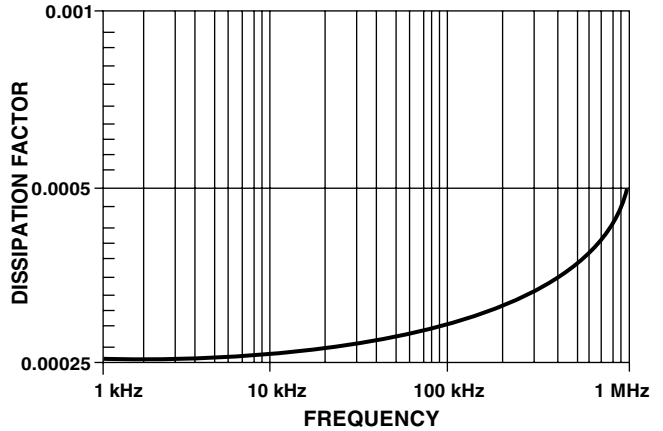



VJ....31/VJ....34 Automotive MLCC

Surface Mount Multilayer Ceramic Chip Capacitors Vishay Vitramon
for Automotive Applications

2.3.2. COG (NP0) DIELECTRIC - TYPICAL PARAMETERS

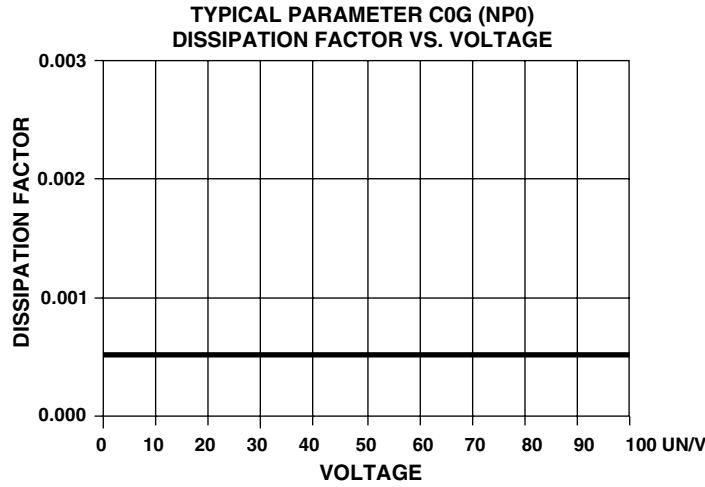

X7R DIELECTRIC - TYPICAL PARAMETERS

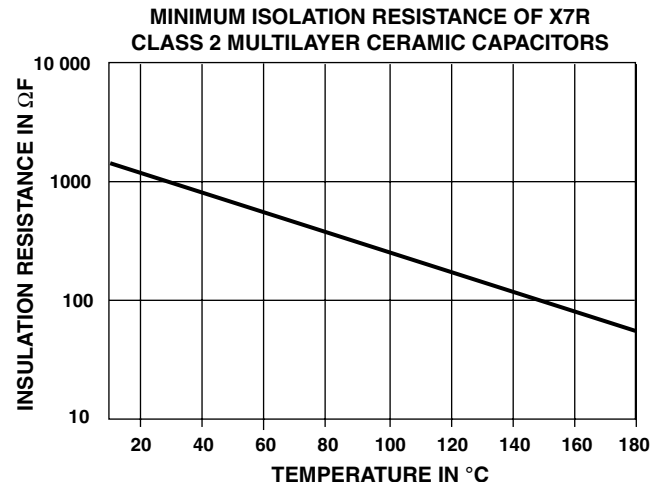
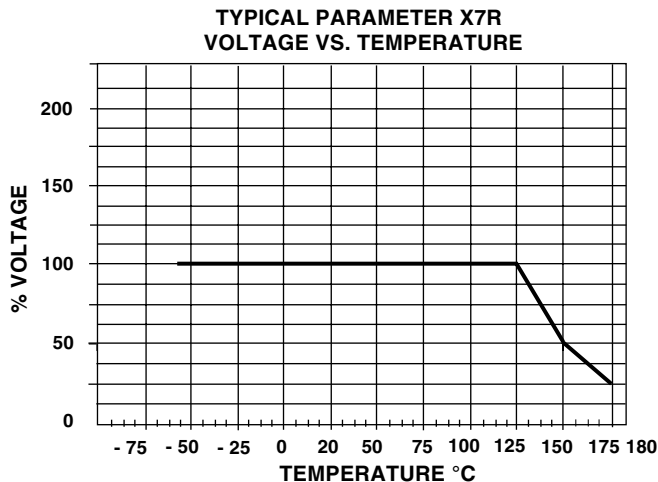
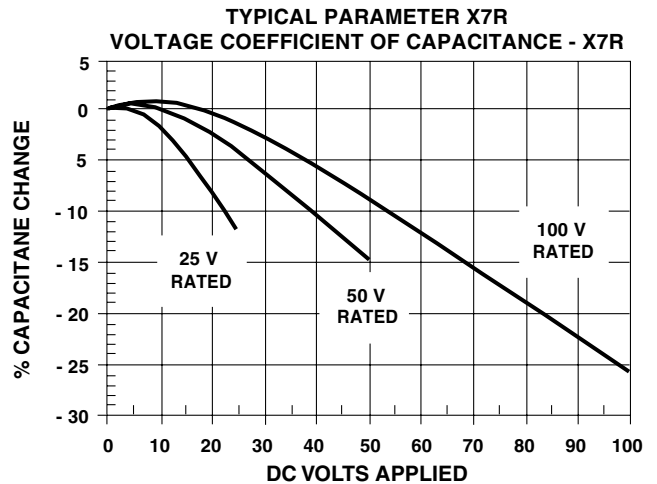
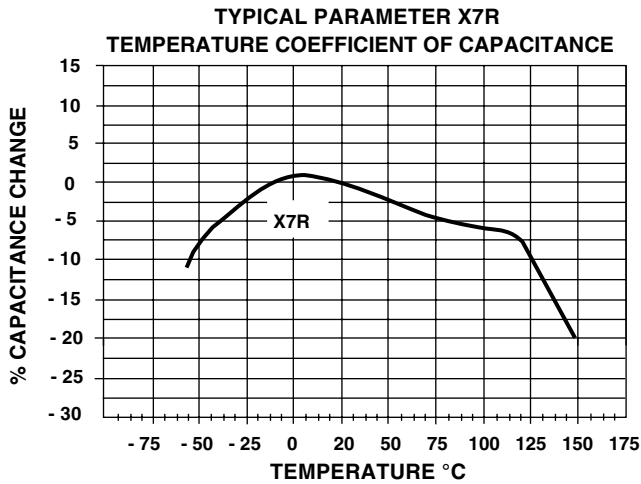

X7R DIELECTRIC - TYPICAL PARAMETERS

TYPICAL PARAMETER X7R
DISSIPATION FACTOR VS. TEMPERATURE

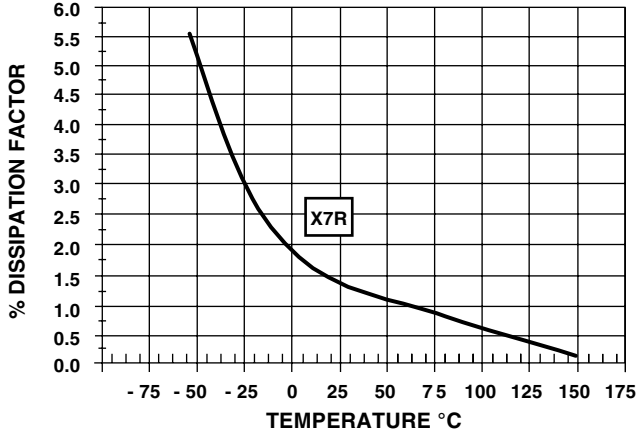

TYPICAL PARAMETER X7R
DISSIPATION FACTOR VS. VOLTAGE

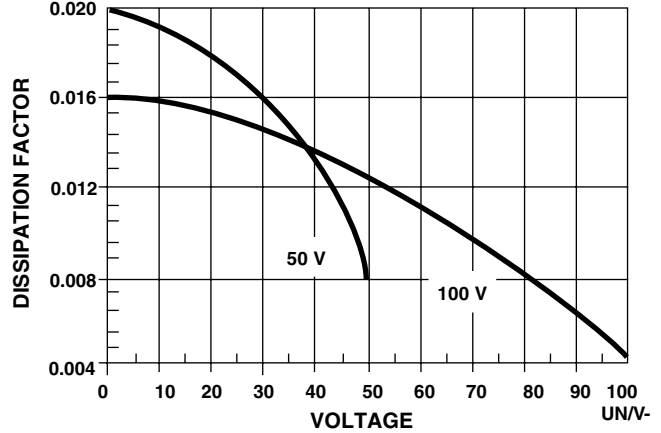

TYPICAL PARAMETER X7R
AGING RATE - X7R

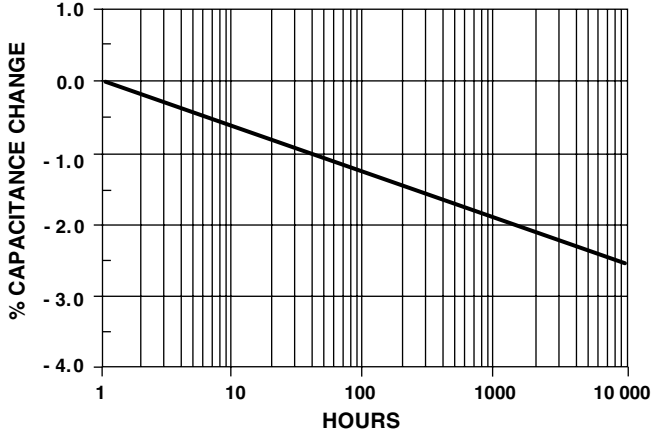

TYPICAL PARAMETER X7R
CHANGE OF DISSIPATION FACTOR WITH FREQUENCY

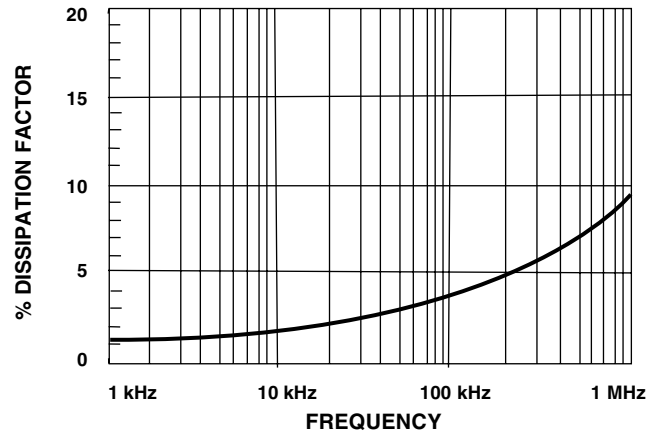

TYPICAL PARAMETER X7R
CHANGE OF CAPACITANCE WITH FREQUENCY

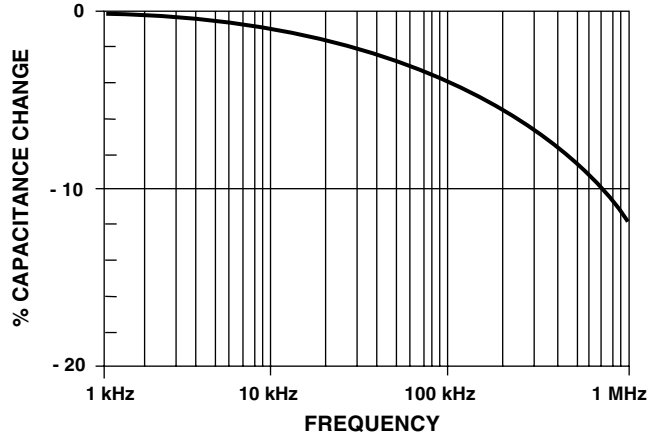

TYPICAL PARAMETER X7R
DISSIPATION FACTOR VS. VOLTAGE

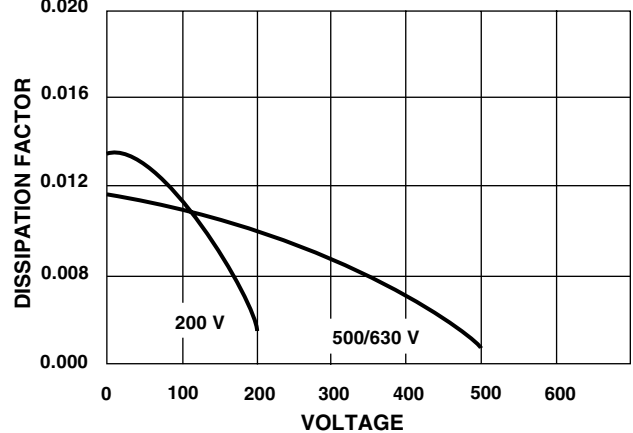



VJ....31/VJ....34 Automotive MLCC

Surface Mount Multilayer Ceramic Chip Capacitors Vishay Vitramon
for Automotive Applications

DIMENSIONS in millimeters						
SIZE	0402	0603	0805	1206	1210	1812
LENGTH	1.0 + 0.1/- 0.5	1.6 ± 0.12	2.0 ± 0.2	3.2 ± 0.25	3.2 ± 0.25	4.50 ± 0.25
WIDTH	0.50 ± 0.1	0.8 ± 0.12	1.25 ± 0.2	1.6 ± 0.25	2.5 ± 0.25	3.20 ± 0.25
THICKNESS MAXIMUM	0.60	0.97	1.40	1.70	1.94	2.18

Information for typical thickness per capacitor is available on request.

3.3. - LOT ACCEPTANCE TESTS

Process tests available in classes (on request)

CLASS	ACTION
A	Components are tested within the monitoring program of the supplier. The supplier shall submit the part numbers of the selected component to the customer during the component specification discussions.
B	Components (customer P/N) shall be tested quarterly. Records available only on special request by the customer.
C	Test with each shipment. Records are provided on a monthly basis. Customer special requirement; requirement should be determined in a specific component specification.

The supplier shall submit the records in electronic format on a monthly basis.

3.3.1

THERMAL STRENGTH, THERMAL SHOCK SENSIBILITY (BIATS)	
SAMPLE SIZE	200
HANDLING	Mounted on PCB
THERMAL SHOCK	1 x 280 °C, no pre-heat, 5 to 10 s
IR - TEST (IRATS)	U = U _r , T = room temperature, verified
BURN IN	Equivalent to 12 h burn-in, 2 x U _r /125 °C, verification time to failure

Acceptance criteria: Zero defects (IRATS and BIATS).

3.3.2

BOARD FLEX	
SAMPLE SIZE	20 pcs/lot
X7R	Every lot
COG	At least three different part numbers of one component family matrix per quarter
MAX DEFLECTION	8 mm (data to be reported, available on request)

3.3.3 Solderability/Resistance to Soldering Heat

Temperature profile for reflow soldering of SMD parts IPC/JEDEC-J-STD-020C.

Test is done on a regular basis for samples taken randomly out of the line.

Acceptance criteria: At least 95 % new solder and no detachment or leaching of terminations.

Solder-ability is guaranteed at least for one year when stored in original package.

Remark: For recommendation only for reflow soldering, see range information (on page 1).

4. ENVIRONMENTAL REQUIREMENTS

A list of the chemical substances content, which must not be used or whose use shall be limited by international law, is available on request.

Vishay confirms that the components specified in this specification do not contain asbestos nor cadmium, not even in the smallest volumes.

The manufacturer/supplier confirms that the component during normal handling, storage and assembly, as well as during operation in the automobile, is non toxic.

5. INSPECTION CRITERIA

5.1 VISUAL INSPECTION - CRITERIA

The supplier shall carry out visual examination with suitable equipment with approximately 10 x magnification and lighting appropriate to the specimen under test and the required quality level.

Chipping

The components shall be free of cracks or fissures. Small damages which do not deteriorate the performance of the component shall be less than 5 % of the surface of the MLCC.

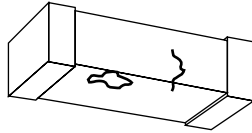

Delamination or Exposed Electrodes

No visible separation or delamination between layers of the capacitor and no exposed electrodes between the two terminals of the capacitor must be seen.

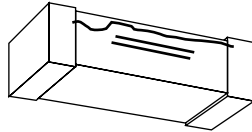

Metallization

For the metallization, no visible detachment of the metallized terminals and no exposed electrodes must be seen. Defects and gaps in the metallization on each sides of the terminal must not exceed 10 % of the total area (e.g. A, B, C, ...). Leaching shall not exceed 25 %.

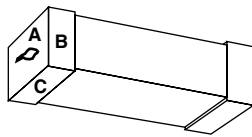

Electrode Distance

The ceramic body shall be free of any conducting material between the terminals which reduces the distance of the electrodes. The minimum distance 'd' is 400 μm for all package sizes, except 0603. For the component package '0603' the minimum distance is 200 μm .

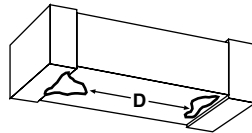



6. - BOARD FLEX/DEFINITION OF TEST CONDITIONS PCB

PCB thickness = (1.6 ± 0.1) mm

Copper thickness = 35 µm

Material FR4 (EP-GC 02 according to DIN 40 802)

LAYOUT/PAD DESIGN Dimensions in mm			
TYPE	PAD SIZE		
	LL	LB	LEL
0603	2.2	1.0	0.75
0805	3.4	1.3	1.2
1206	4.5	1.8	1.2
1210	4.5	2.8	1.3

LL = total length; LB = width of the pad; LEL = single pad length

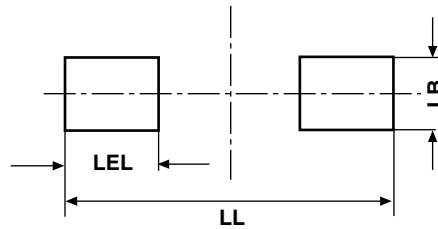

SOLDERING INSTRUCTIONS

Type of recommended solder;

reflow: 63/37 SnPb (DIN 32513)

wave: 63/37

THICKNESS, RECOMMENDED FOR SOLDER PASTE (reflow soldering)	
TYPE	THICKNESS IN µm
0603	150 to 200
0805	150 to 200
1206	150 to 200
1210	150 to 200

TYPICAL TEMPERATURE PROFILE FOR REFLOW SOLDERING

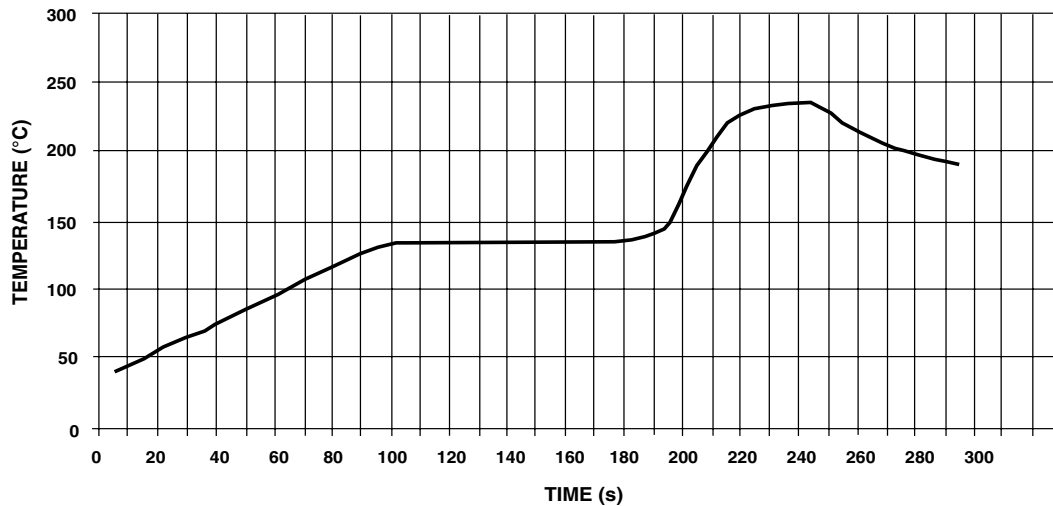

VJ....31/VJ....34 Automotive MLCC

Vishay Vitramon Surface Mount Multilayer Ceramic Chip Capacitors for Automotive Applications



MOUNTING, DIMENSIONS AND TESTING

MOUNTING

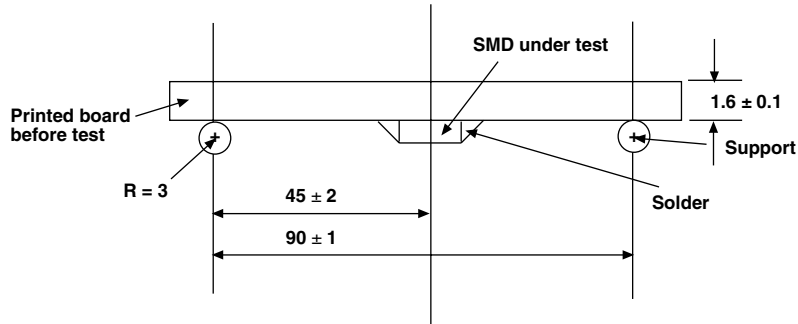

TESTING

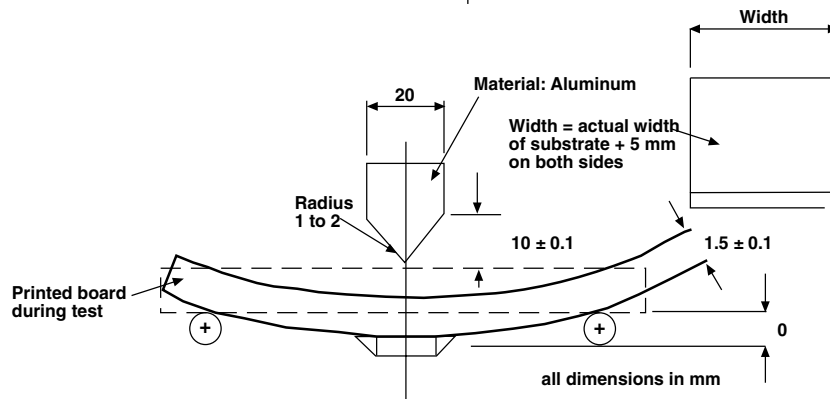

PERFORMANCE OF THE TEST(S)

Electrical Test according to component specification
 Mounting to PCB
 Storage at room temperature (min. 10 h)
 Board Flex Test

Details

X7R	PCB to be deflected continuously, speed 1 mm/s (± 0.5 mm/s).
COG	PCB to be deflected in steps until cracks or other damages are visible or can be measured. Dwell time between steps: 5 ± 1 s

Failure criteria

X7R	Piezoelectric sensor, no failure up to 2 mm
COG	$\Delta C/C < 1\%$ or < 1 pF, no failure up to 3 mm
BOTH	Electrical test according to component specification



Notice

Specifications of the products displayed herein are subject to change without notice. Vishay Intertechnology, Inc., or anyone on its behalf, assumes no responsibility or liability for any errors or inaccuracies.

Information contained herein is intended to provide a product description only. No license, express or implied, by estoppel or otherwise, to any intellectual property rights is granted by this document. Except as provided in Vishay's terms and conditions of sale for such products, Vishay assumes no liability whatsoever, and disclaims any express or implied warranty, relating to sale and/or use of Vishay products including liability or warranties relating to fitness for a particular purpose, merchantability, or infringement of any patent, copyright, or other intellectual property right.

The products shown herein are not designed for use in medical, life-saving, or life-sustaining applications. Customers using or selling these products for use in such applications do so at their own risk and agree to fully indemnify Vishay for any damages resulting from such improper use or sale.