

3875081 G E SOLID STATE

General-Purpose Power Transistors

01E 17450

D T-33-13

T-33-21

2N6486, 2N6487, 2N6488, 2N6489, 2N6490, 2N6491

File Number 678

15-A, 75-W, Silicon N-P-N and P-N-P Epitaxial-Base VERSAWATT Transistors

Complementary Pairs for General-Purpose Switching and Amplifier Applications

Features:

- Maximum safe-area-of-operation curves

RCA-2N6486—2N6491*, inclusive, are epitaxial-base silicon transistors. The 2N6486, 2N6487, and 2N6488 are n-p-n complements of p-n-p types 2N6489, 2N6490, and 2N6491, respectively. All these devices are intended for a wide variety of medium-power switching and amplifier applications, and are particularly useful in high-fidelity amplifiers utilizing complementary-symmetry circuits.

These devices are supplied in the TO-220AB (VERSA-WATT) plastic package.

- Formerly RCA Dev. Nos. TA8325, TA8324, TA8323, TA8328, TA8327, and TA8326, respectively.

TERMINAL DESIGNATIONS

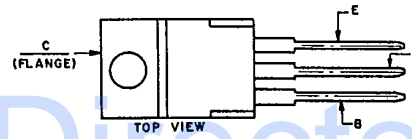

DataSheet.Directory

MAXIMUM RATINGS, Absolute-Maximum Values:

	N-P-N	2N6486	2N6487	2N6488	
	P-N-P	2N6489†	2N6490†	2N6491†	
*COLLECTOR-TO-BASE VOLTAGE.....	V_{CBO}	50	70	90	V
COLLECTOR-TO-EMITTER VOLTAGE:					
* With 1.5 volts (V_{BE}) of reverse bias, and external base-to-emitter resistance (R_{BE}) = 100 Ω	V_{CEX}	50	70	90	V
With external base-to-emitter resistance (R_{BE}) = 100 Ω	V_{CER}	45	65	85	V
With base open	V_{CEO}	40	60	80	V
*EMITTER-TO-BASE VOLTAGE	V_{EBO}	5	5	5	V
*CONTINUOUS COLLECTOR CURRENT.....	I_C	15	15	15	A
*CONTINUOUS BASE CURRENT	I_B	5	5	5	A
*TRANSISTOR DISSIPATION:	P_T				
At case temperatures up to 25°C		57	75	75	W
At ambient temperatures up to 25°C		1.8	1.8	1.8	W/°C
At case temperatures above 25°C			Derate linearly 0.6		W/°C
At ambient temperatures above 25°C			Derate linearly 0.0144		W/°C
*TEMPERATURE RANGE:					
Storage and operating (Junction)			-65 to +150		°C
*LEAD TEMPERATURE (During soldering):					
At distance \geq 1/8 in. (3.17 mm) from seating plane for 10 s max.			235		°C

* In accordance with JEDEC registration data format JS-6 RDF-2.

† For p-n-p devices, voltage and current values are negative.

3875081 G E SOLID STATE

01E 17451 D T-33-13

General-Purpose Power Transistors

2N6486, 2N6487, 2N6488, 2N6489, 2N6490, 2N6491

ELECTRICAL CHARACTERISTICS, At case temperature (T_C) = 25°C unless otherwise specified

T-33-21

CHARACTERISTIC	SYMBOL	TEST CONDITIONS			LIMITS						UNITS
		VOLTAGE V dc		CURR. A dc	2N6486 2N6489 [†]		2N6487 2N6490 [†]		2N6488 2N6491 [†]		
		V _{CE}	V _{BE}	I _C	Min.	Max.	Min.	Max.	Min.	Max.	
Collector-Cutoff Current: With external base-emitter resistance (R _{BE}) = 100Ω	I _{CER}	35 55 75			-	500	-	500	-	500	μA
With base-emitter junction reverse biased and external base-to-emitter resistance (R _{BE}) = 100Ω	I _{CEX}	45 65 85	-1.5 -1.5 -1.5		-	500	-	500	-	500	μA
At T _C = 150°C		40 60 80	-1.5 -1.5 -1.5		-	5	-	5	-	5	mA
With base open	I _{CEO}	20 30 40			-	1	-	1	-	1	mA
Emitter-Cutoff Current	I _{EBO}		-5	0	-	1	-	1	-	1	mA
DC Forward-Current Transfer Ratio	h _{FE}	4 4		5 ^a 15 ^a	20 5	150 -	20 5	150 -	20 5	150 -	
Collector-to-Emitter Sustaining Voltage With base open	V _{CEO(sus)}			0.2	40 ^b	-	60 ^b	-	80 ^b	-	V
With external base-emitter resistance (R _{BE}) = 100Ω	V _{CER(sus)}			0.2	45 ^b	-	65 ^b	-	85 ^b	-	V
With base-emitter junction reverse- biased and external base-to-emitter resistance (R _{BE}) = 100Ω	V _{CEX(sus)}		-1.5	0.2	50 ^b	-	70 ^b	-	90 ^b	-	V
Base-to-Emitter Voltage	V _{BE}	4 4		5 ^a 15 ^a	-	1.3 3.5	-	1.3 3.5	-	1.3 3.5	V
Collector-to-Emitter Saturation Voltage	V _{CE(sat)}			5 ^a 15 ^a	-	1.3 3.5	-	1.3 3.5	-	1.3 3.5	V
Magnitude of Common-Emitter Small-Signal Short-Circuit Forward-Current Transfer Ratio; f = 1 MHz	h _{fe}	4		1	5	-	5	-	5	-	
Common-Emitter, Small-Signal, Short-Circuit, Forward-Current Transfer Ratio (f = 1 kHz)	h _{fe}	4		1	25	-	25	-	25	-	
Thermal Resistance: Junction-to-case	R _{θJC}				-	1.67	-	1.67	-	1.67	°C/W
Junction-to-ambient	R _{θJA}				-	-	70	-	70	-	°C/W

^a In accordance with JEDEC registration data format (JS-6 RDF-2). ^b CAUTION: Sustaining voltages V_{CEO(sus)}, V_{CER(sus)}, and V_{CEX(sus)} MUST NOT be measured on a curve tracer.

[†] Pulsed; pulse duration = 300 μs, duty factor = 1.8%.

[♦] For p-n-p devices, voltage and current values are negative.

3875081 G E SOLID STATE
General-Purpose Power Transistors

01E 17452 D T-33-13

T-33-21

2N6486, 2N6487, 2N6488, 2N6489, 2N6490, 2N6491

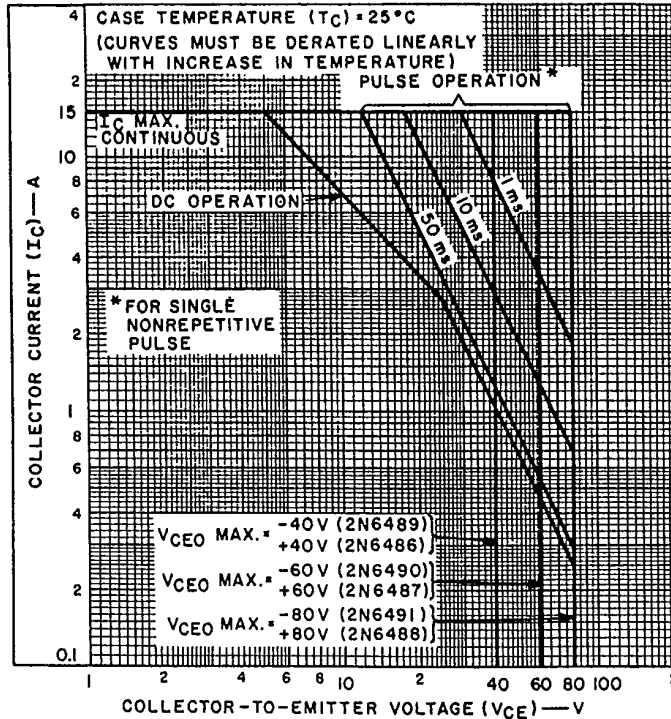

92CS-22805

Fig. 1 — Maximum operating areas for all types†.

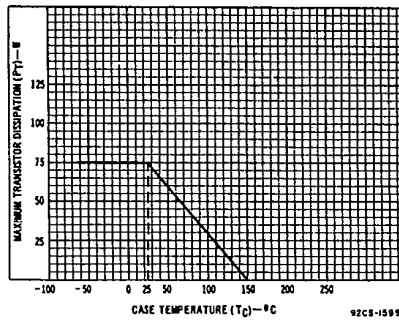

92CS-15998

Fig. 2 — Derating chart for all types

† For p-n-p devices, voltage and current values are negative.

T-33-21

2N6486, 2N6487, 2N6488, 2N6489, 2N6490, 2N6491

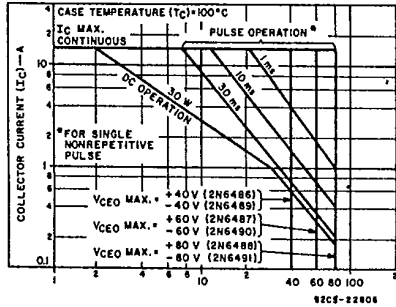

Fig. 3 — Maximum operating areas for all types†.

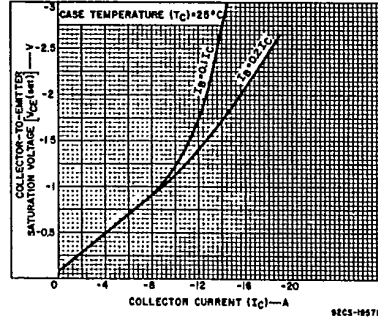

Fig. 4 — Typical collector-to-emitter saturation-voltage characteristics for all types.

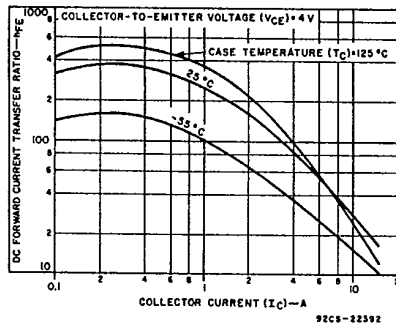

Fig. 5 — Typical dc beta characteristics for 2N6486, 2N6487, and 2N6488.

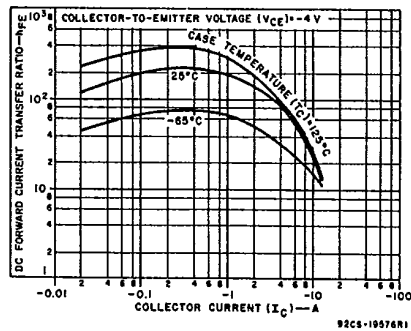

Fig. 6 — Typical dc beta characteristics for 2N6489, 2N6490, and 2N6491.

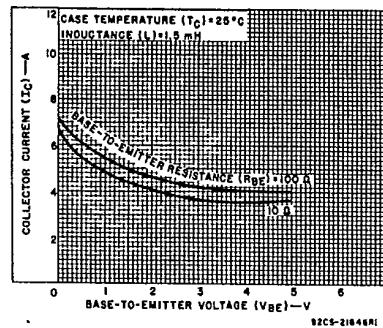

Fig. 7 — Minimum reverse-bias second-breakdown characteristics for all types†.

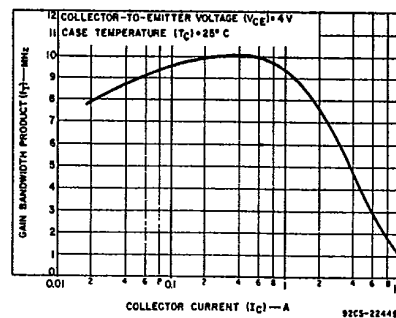

Fig. 8 — Typical gain-bandwidth product vs. collector current for all types†.

† For p-n-p devices, voltage and current values are negative.

3875081 G E SOLID STATE
General-Purpose Power Transistors

01E 17454 D T-33-13

T-33-21

2N6486, 2N6487, 2N6488, 2N6489, 2N6490, 2N6491

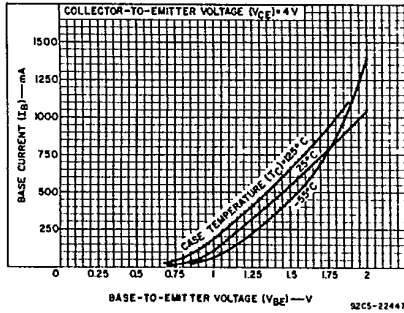

Fig. 9 — Typical input characteristics for all types†.

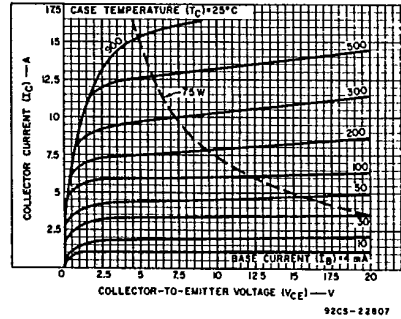

Fig. 10 — Typical output characteristics for all types†.

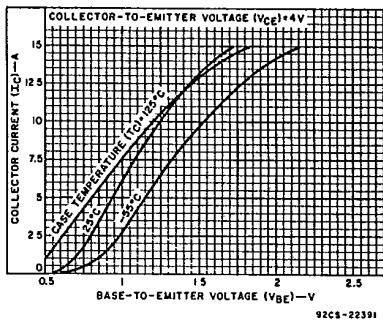

Fig. 11 — Typical transfer characteristics for all types†.

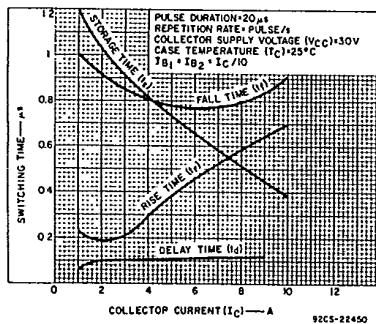

Fig. 12 — Typical saturated switching characteristics for 2N6486, 2N6487, and 2N6488.

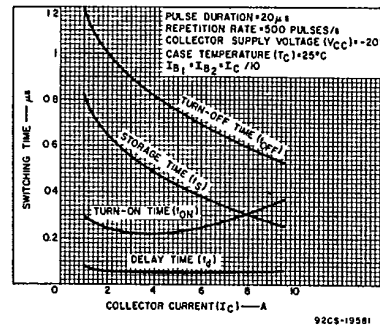

Fig. 13 — Typical saturated switching characteristics for 2N6489, 2N6490, and 2N6491.

† For p-n-p devices, voltage and current values are negative.

2N6486, 2N6487, 2N6488, 2N6489, 2N6490, 2N6491

T-33-21

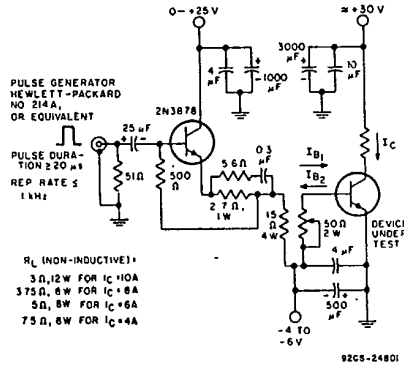

Fig. 14 — Circuit used to measure switching times for 2N6486, 2N6487, and 2N6488.

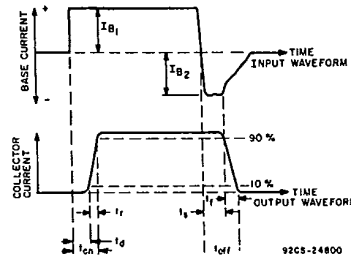

Fig. 15 — Phase relationship between input and output currents showing reference points for specification of switching times (test circuit shown in Fig. 14).

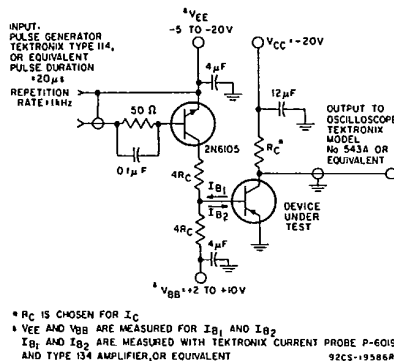

Fig. 16 — Circuit used to measure switching times for 2N6489, 2N6490, and 2N6491.

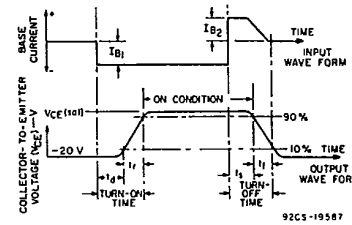

Fig. 17 — Oscilloscope display for measurement for switching times (test circuit shown in Fig. 16).

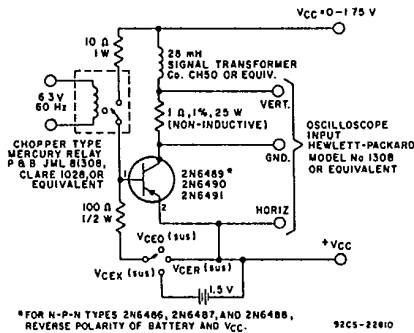

Fig. 18 — Circuit used to measure sustaining voltages $V_{CE0}(sus)$, $V_{CE1}(sus)$, and $V_{CE2}(sus)$ for all types.

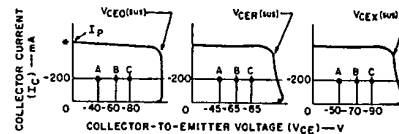

Fig. 19 — Oscilloscope display for measurement of sustaining voltages (test circuit shown in Fig. 18).