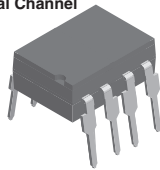
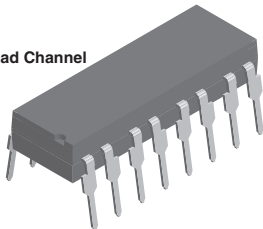


Optocoupler, Phototransistor Output (Dual, Quad Channel)

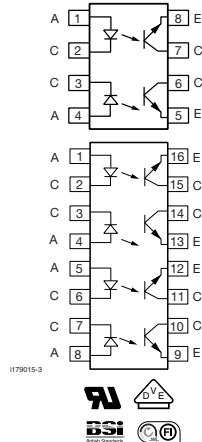
Dual Channel



Quad Channel



i179012-1



FEATURES

- Current transfer ratio at $I_F = 10 \text{ mA}$
- Isolation rated voltage $4420 V_{RMS}$
- Material categorization: for definitions of compliance please see www.vishay.com/doc?99912



RoHS COMPLIANT

AGENCY APPROVALS

- UL1577, file no. E52744, double protection
- cUL tested to CSA 22.2 bulletin 5A
- CSA 93751
- BSI EN 60950, BSI EN 60065
- DIN EN 60747-5-5 (VDE 0884-5) available with option 1
- FIMKO

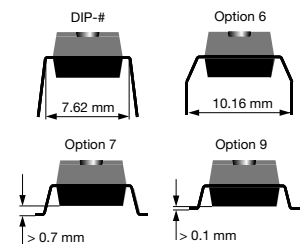
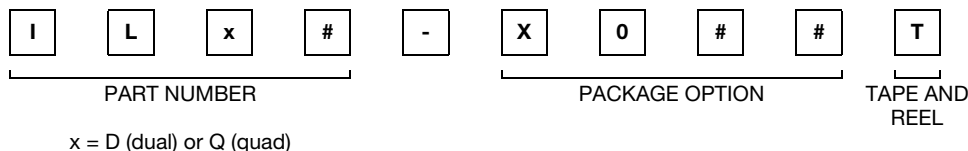
DESCRIPTION

The ILD1, ILD2, ILD5, ILQ1, ILQ2 are optically coupled isolated pairs employing GaAs infrared LEDs and silicon NPN phototransistor. Signal information, including a DC level, can be transmitted by the drive while maintaining a high degree of electrical isolation between input and output.

The ILD1, ILD2, ILD5, ILQ1, ILQ2 are especially designed for driving medium-speed logic and can be used to eliminate troublesome ground loop and noise problems. Also these couplers can be used to replace relays and transformers in many digital interface applications such as CTR modulation.

The ILD1, ILD2, ILD5 have two isolated channels in a single DIP package and the ILQ1, ILQ2 have four isolated channels per package.

ORDERING INFORMATION



AGENCY CERTIFIED/PACKAGE	DUAL CHANNEL			QUAD CHANNEL	
	CTR (%)				
UL, CSA, BSI, FIMKO	20 to 300	100 to 500	50 to 400	20 to 300	100 to 500
DIP-8	ILD1	ILD2	ILD5	-	-
DIP-8, 400 mil, option 6	-	ILD2-X006	-	-	-
SMD-8, option 7	ILD1-X007T ⁽¹⁾	ILD2-X007T ⁽¹⁾	-	-	-
SMD-8, option 9	ILD1-X009T ⁽¹⁾	ILD2-X009T ⁽¹⁾	ILD5-X009T ⁽¹⁾	-	-
DIP-16	-	-	-	ILQ1	ILQ2
DIP-16, 400 mil, option 6	-	-	-	ILQ1-X006	ILQ2-X006
SMD-16, option 7	-	-	-	ILQ1-X007	ILQ2-X007T ⁽¹⁾
SMD-16, option 9	-	-	-	ILQ1-X009T ⁽¹⁾	ILQ2-X009T ⁽¹⁾



AGENCY CERTIFIED/PACKAGE	DUAL CHANNEL			QUAD CHANNEL	
	CTR (%)				
VDE, UL, CSA, BSI, FIMKO	20 to 300	100 to 500	50 to 400	20 to 300	100 to 500
DIP-8	ILD1-X001	ILD2-X001	ILD5-X001	-	-
DIP-8, 400 mil, option 6	-	ILD2-X016	-	-	-
SMD-8, option 7	-	ILD2-X017	-	-	-
SMD-8, option 9	ILD1-X019T	-	-	-	-
DIP-16	-	-	-	-	ILQ2-X001
DIP-16, 400 mil, option 6	-	-	-	-	ILQ2-X016
SMD-16, option 7	-	-	-	-	ILQ2-X017T ⁽¹⁾

Notes

- Additional options may be possible, please contact sales office

⁽¹⁾ Also available in tubes; do not put T on end

ABSOLUTE MAXIMUM RATINGS ($T_{amb} = 25\text{ }^{\circ}\text{C}$, unless otherwise specified)					
PARAMETER	TEST CONDITION	PART	SYMBOL	VALUE	UNIT
INPUT					
Reverse voltage			V_R	6	V
Forward current			I_F	60	mA
Surge current			I_{FSM}	2.5	A
Power dissipation			P_{diss}	100	mW
Derate linearly from 25 °C				1.3	mW/°C
OUTPUT					
Collector emitter reverse voltage		ILD1	V_{CEO}	50	V
		ILQ1	V_{CEO}	50	V
		ILD2	V_{CEO}	70	V
		ILQ2	V_{CEO}	70	V
		ILD5	V_{CEO}	70	V
Collector current			I_C	50	mA
	$t < 1\text{ ms}$		I_C	400	mA
Power dissipation			P_{diss}	200	mW
Derate linearly from 25 °C				2.6	mW/°C
COUPLER					
Package power dissipation			P_{tot}	250	mW
Derate linearly from 25 °C				3.3	mW/°C
Storage temperature			T_{stg}	-40 to +150	°C
Operating temperature			T_{amb}	-40 to +100	°C
Junction temperature			T_j	100	°C
Soldering temperature ⁽¹⁾	2 mm from case bottom		T_{slid}	260	°C

Notes

- Stresses in excess of the absolute maximum ratings can cause permanent damage to the device. Functional operation of the device is not implied at these or any other conditions in excess of those given in the operational sections of this document. Exposure to absolute maximum ratings for extended periods of the time can adversely affect reliability

⁽¹⁾ Refer to reflow profile for soldering conditions for surface mounted devices (SMD). Refer to wave profile for soldering conditions for through hole devices (DIP)

ELECTRICAL CHARACTERISTICS ($T_{amb} = 25\text{ }^{\circ}\text{C}$, unless otherwise specified)						
PARAMETER	TEST CONDITION	SYMBOL	MIN.	TYP.	MAX.	UNIT
INPUT						
Forward voltage	$I_F = 60\text{ mA}$	V_F	-	1.25	1.65	V
Reverse current	$V_R = 6\text{ V}$	I_R	-	0.01	10	μA
Capacitance	$V_R = 0\text{ V}, f = 1\text{ MHz}$	C_O	-	25	-	pF
Thermal resistance, junction to lead		T_{thJL}	-	750	-	K/W
OUTPUT						
Collector emitter capacitance	$V_{CE} = 5\text{ V}, f = 1\text{ MHz}$	C_{CE}	-	6.8	-	pF
Collector emitter leakage current	$V_{VCE} = 10\text{ V}$	I_{CEO}	-	5	50	nA
Saturation voltage, collector emitter	$I_C = 1\text{ mA}, I_B = 20\text{ }\mu\text{A}$	V_{CESAT}	-	0.25	0.4	V
DC forward current gain	$V_{CE} = 10\text{ V}, I_B = 20\text{ }\mu\text{A}$	h_{FE}	200	650	1800	
DC forward current gain saturated	$V_{CE} = 0.4\text{ V}, I_B = 20\text{ }\mu\text{A}$	h_{FEsat}	120	400	600	
Thermal resistance, junction to lead		R_{thjL}	-	500	-	K/W
COUPLER						
Capacitance (input to output)	$V_{IO} = 0\text{ V}, f = 1\text{ MHz}$	C_{IO}	-	0.8	-	pF

Note

- Minimum and maximum values are testing requirements. Typical values are characteristics of the device and are the result of engineering evaluation. Typical values are for information only and are not part of the testing requirements

CURRENT TRANSFER RATIO ($T_{amb} = 25\text{ }^{\circ}\text{C}$, unless otherwise specified)							
PARAMETER	TEST CONDITION	PART	SYMBOL	MIN.	TYP.	MAX.	UNIT
I_C/I_F (collector emitter saturated)	$I_F = 10\text{ mA}, V_{CE} = 0.4\text{ V}$	ILD1	CTR_{CEsat}	-	75	-	%
		ILQ1	CTR_{CEsat}	-	75	-	%
		ILD2	CTR_{CEsat}	-	170	-	%
		ILQ2	CTR_{CEsat}	-	170	-	%
		ILD5	CTR_{CEsat}	-	100	-	%
	$I_F = 10\text{ mA}, V_{CE} = 10\text{ V}$	ILD1	CTR_{CE}	20	80	300	%
		ILQ1	CTR_{CE}	20	80	300	%
		ILD2	CTR_{CE}	100	200	500	%
		ILQ2	CTR_{CE}	100	200	500	%
		ILD5	CTR_{CE}	50	130	400	%

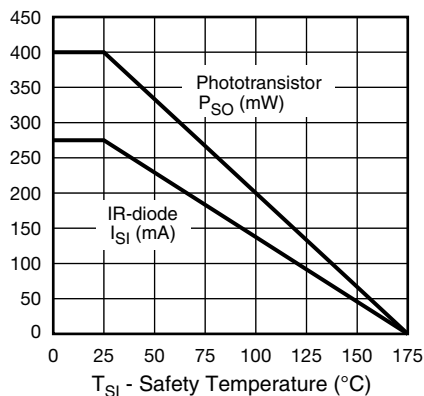


Fig. 1 - Derating Diagram

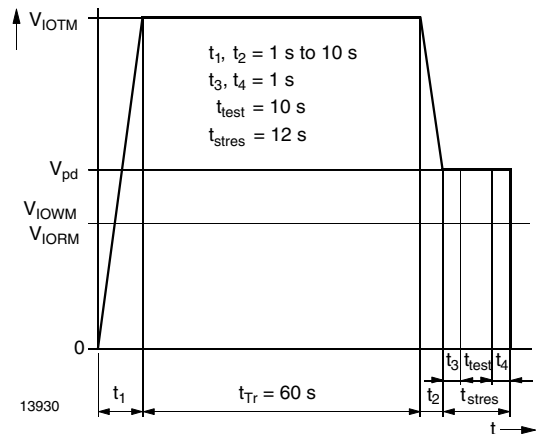


Fig. 2 - Test Pulse Diagram for Sample Test according to DIN EN 60747-5-2 (VDE 0884); IEC 60747-5-5



SWITCHING CHARACTERISTICS (T _{amb} = 25 °C, unless otherwise specified)							
PARAMETER	TEST CONDITION	PART	SYMBOL	MIN.	TYP.	MAX.	UNIT
NON-SATURATED							
Current	V _{CE} = 5 V, R _L = 75 Ω, 50 % of V _{PP}	ILD1	I _F	-	20	-	mA
		ILQ1	I _F	-	20	-	mA
		ILD2	I _F	-	5	-	mA
		ILQ2	I _F	-	5	-	mA
		ILD5	I _F	-	10	-	mA
Delay	V _{CE} = 5 V, R _L = 75 Ω, 50 % of V _{PP}	ILD1	t _D	-	0.8	-	μs
		ILQ1	t _D	-	0.8	-	μs
		ILD2	t _D	-	1.7	-	μs
		ILQ2	t _D	-	1.7	-	μs
		ILD5	t _D	-	1.7	-	μs
Rise time	V _{CE} = 5 V, R _L = 75 Ω, 50 % of V _{PP}	ILD1	t _r	-	1.9	-	μs
		ILQ1	t _r	-	1.9	-	μs
		ILD2	t _r	-	2.6	-	μs
		ILQ2	t _r	-	2.6	-	μs
		ILD5	t _r	-	2.6	-	μs
Storage	V _{CE} = 5 V, R _L = 75 Ω, 50 % of V _{PP}	ILD1	t _s	-	0.2	-	μs
		ILQ1	t _s	-	0.2	-	μs
		ILD2	t _s	-	0.4	-	μs
		ILQ2	t _s	-	0.4	-	μs
		ILD5	t _s	-	0.4	-	μs
Fall time	V _{CE} = 5 V, R _L = 75 Ω, 50 % of V _{PP}	ILD1	t _f	-	1.4	-	μs
		ILQ1	t _f	-	1.4	-	μs
		ILD2	t _f	-	2.2	-	μs
		ILQ2	t _f	-	2.2	-	μs
		ILD5	t _f	-	2.2	-	μs
Propagation H to L	V _{CE} = 5 V, R _L = 75 Ω, 50 % of V _{PP}	ILD1	t _{PHL}	-	0.7	-	μs
		ILQ1	t _{PHL}	-	0.7	-	μs
		ILD2	t _{PHL}	-	1.2	-	μs
		ILQ2	t _{PHL}	-	1.2	-	μs
		ILD5	t _{PHL}	-	1.1	-	μs
Propagation L to H	V _{CE} = 5 V, R _L = 75 Ω, 50 % of V _{PP}	ILD1	t _{PLH}	-	1.4	-	μs
		ILQ1	t _{PLH}	-	1.4	-	μs
		ILD2	t _{PLH}	-	2.3	-	μs
		ILQ2	t _{PLH}	-	2.3	-	μs
		ILD5	t _{PLH}	-	2.5	-	μs



SWITCHING CHARACTERISTICS (T _{amb} = 25 °C, unless otherwise specified)							
PARAMETER	TEST CONDITION	PART	SYMBOL	MIN.	TYP.	MAX.	UNIT
SATURATED							
Current	V _{CE} = 0.4 V, R _L = 1 kΩ, V _{CC} = 5 V, V _{TH} = 1.5 V	ILD1	I _F	-	20	-	mA
		ILQ1	I _F	-	20	-	mA
		ILD2	I _F	-	5	-	mA
		ILQ2	I _F	-	5	-	mA
		ILD5	I _F	-	10	-	mA
Delay	V _{CE} = 0.4 V, R _L = 1 kΩ, V _{CC} = 5 V, V _{TH} = 1.5 V	ILD1	t _D	-	0.8	-	μs
		ILQ1	t _D	-	0.8	-	μs
		ILD2	t _D	-	1	-	μs
		ILQ2	t _D	-	1	-	μs
		ILD5	t _D	-	1.7	-	μs
Rise time	V _{CE} = 0.4 V, R _L = 1 kΩ, V _{CC} = 5 V, V _{TH} = 1.5 V	ILD1	t _r	-	1.2	-	μs
		ILQ1	t _r	-	1.2	-	μs
		ILD2	t _r	-	2	-	μs
		ILQ2	t _r	-	2	-	μs
		ILD5	t _r	-	7	-	μs
Storage	V _{CE} = 0.4 V, R _L = 1 kΩ, V _{CC} = 5 V, V _{TH} = 1.5 V	ILD1	t _s	-	7.4	-	μs
		ILQ1	t _s	-	7.4	-	μs
		ILD2	t _s	-	5.4	-	μs
		ILQ2	t _s	-	5.4	-	μs
		ILD5	t _s	-	4.6	-	μs
Fall time	V _{CE} = 0.4 V, R _L = 1 kΩ, V _{CC} = 5 V, V _{TH} = 1.5 V	ILD1	t _f	-	7.6	-	μs
		ILQ1	t _f	-	7.6	-	μs
		ILD2	t _f	-	13.5	-	μs
		ILQ2	t _f	-	13.5	-	μs
		ILD5	t _f	-	20	-	μs
Propagation H to L	V _{CE} = 0.4 V, R _L = 1 kΩ, V _{CC} = 5 V, V _{TH} = 1.5 V	ILD1	t _{PHL}	-	1.6	-	μs
		ILQ1	t _{PHL}	-	1.6	-	μs
		ILD2	t _{PHL}	-	5.4	-	μs
		ILQ2	t _{PHL}	-	5.4	-	μs
		ILD5	t _{PHL}	-	2.6	-	μs
Propagation L to H	V _{CE} = 0.4 V, R _L = 1 kΩ, V _{CC} = 5 V, V _{TH} = 1.5 V	ILD1	t _{PLH}	-	8.6	-	μs
		ILQ1	t _{PLH}	-	8.6	-	μs
		ILD2	t _{PLH}	-	7.4	-	μs
		ILQ2	t _{PLH}	-	7.4	-	μs
		ILD5	t _{PLH}	-	7.2	-	μs

COMMON MODE TRANSIENT IMMUNITY (T _{amb} = 25 °C, unless otherwise specified)							
PARAMETER	TEST CONDITION	SYMBOL	MIN.	TYP.	MAX.	UNIT	
Common mode rejection, output high	V _{CM} = 50 V _{P-P} , R _L = 1 kΩ, I _F = 0 mA	CM _H	-	5000	-	V/μs	
Common mode rejection, output low	V _{CM} = 50 V _{P-P} , R _L = 1 kΩ, I _F = 10 mA	CM _L	-	5000	-	V/μs	
Common mode coupling capacitance		C _{CM}	-	0.01	-	pF	

SAFETY AND INSULATION RATINGS				
PARAMETER	TEST CONDITION	SYMBOL	VALUE	UNIT
Climatic classification	According to IEC 68 part 1		40/100/21	
Comparative tracking index		CTI	175	
Maximum rated withstanding isolation voltage	$t = 1 \text{ min}$	V_{ISO}	4420	V_{RMS}
Maximum transient isolation voltage		V_{IOTM}	10 000	V_{peak}
Maximum repetitive peak isolation voltage		V_{IORM}	890	V_{peak}
Isolation resistance	$V_{IO} = 500 \text{ V}, T_{amb} = 25 \text{ }^\circ\text{C}$	R_{IO}	$\geq 10^{12}$	Ω
	$V_{IO} = 500 \text{ V}, T_{amb} = 100 \text{ }^\circ\text{C}$	R_{IO}	$\geq 10^{11}$	Ω
Output safety power		P_{SO}	400	mW
Input safety current		I_{SI}	275	mA
Safety temperature		T_S	175	$^\circ\text{C}$
Creepage distance			≥ 7	mm
Clearance distance			≥ 7	mm
Insulation thickness		DTI	≥ 0.4	mm

Note

- As per IEC 60747-5-5, § 7.4.3.8.2, this optocoupler is suitable for “safe electrical insulation” only within the safety ratings. Compliance with the safety ratings shall be ensured by means of protective circuits

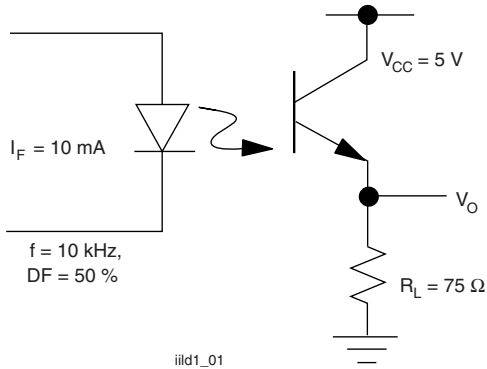
TYPICAL CHARACTERISTICS ($T_{amb} = 25 \text{ }^\circ\text{C}$, unless otherwise specified)


Fig. 3 - Non-Saturated Switching Schematic

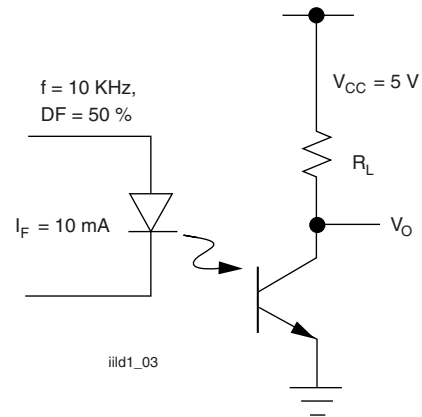


Fig. 5 - Saturated Switching Schematic

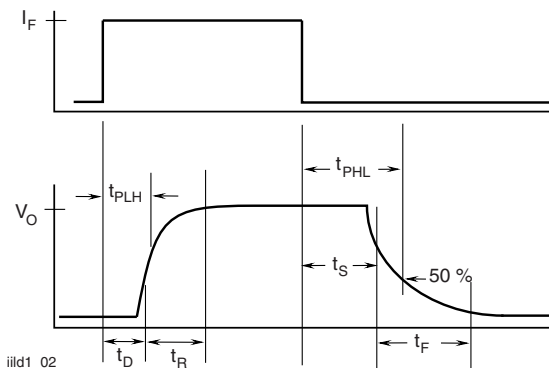


Fig. 4 - Non-Saturated Switching Timing

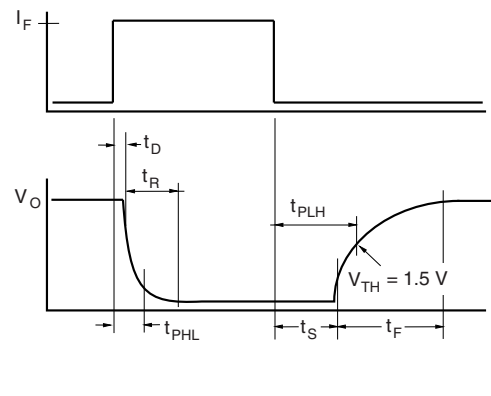


Fig. 6 - Saturated Switching Timing

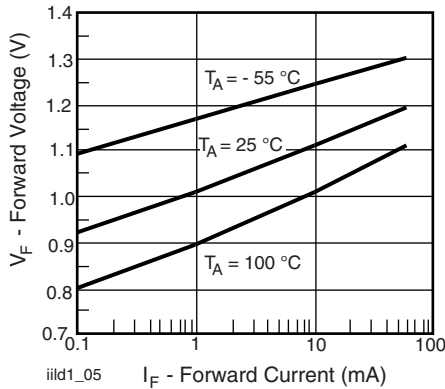


Fig. 7 - Normalized Non-Saturated and Saturated CTR vs. LED Current

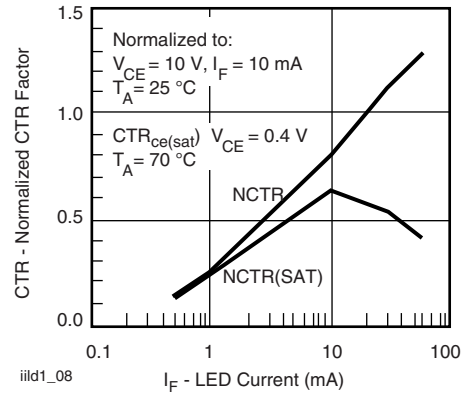


Fig. 10 - Normalized Non-Saturated and Saturated CTR vs. LED Current

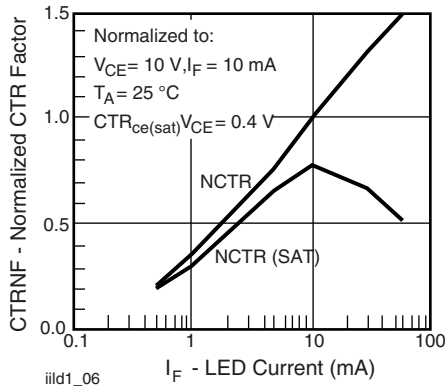


Fig. 8 - Normalized Non-Saturated and Saturated CTR vs. LED Current

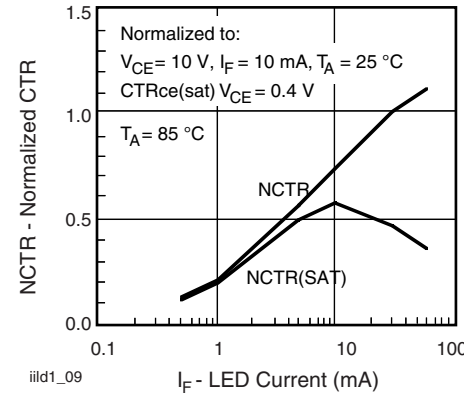


Fig. 11 - Normalized Non-Saturated and Saturated CTR vs. LED Current

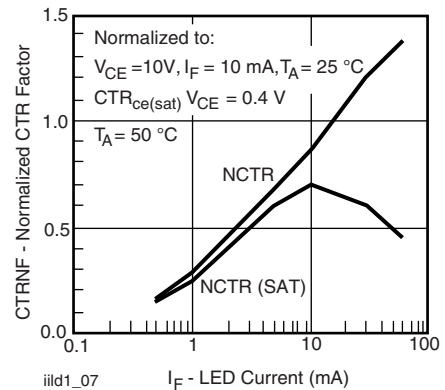


Fig. 9 - Normalized Non-Saturated and Saturated CTR vs. LED Current

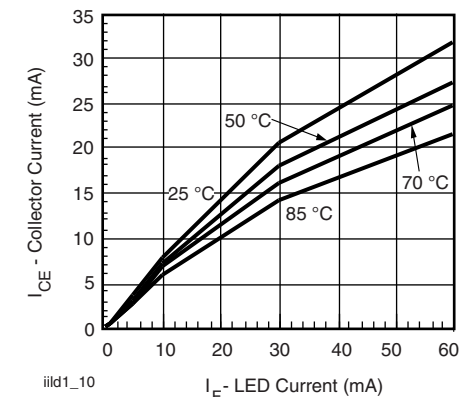


Fig. 12 - Collector Emitter Current vs. Temperature and LED Current

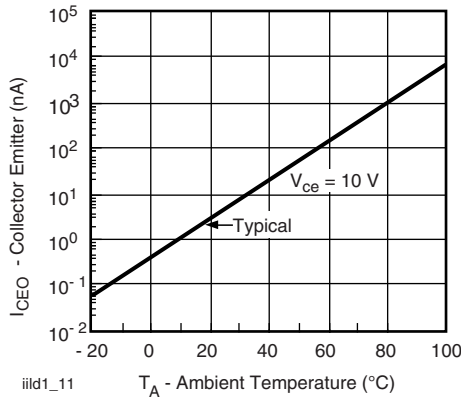


Fig. 13 - Collector Emitter Leakage Current vs. Temperature

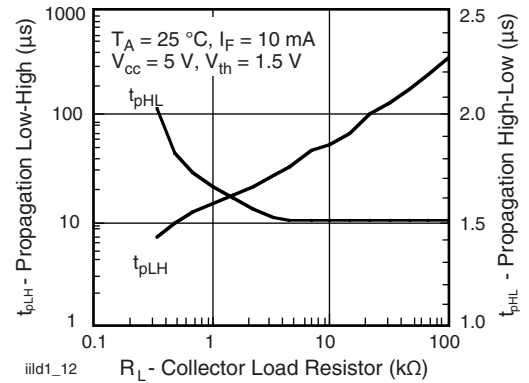
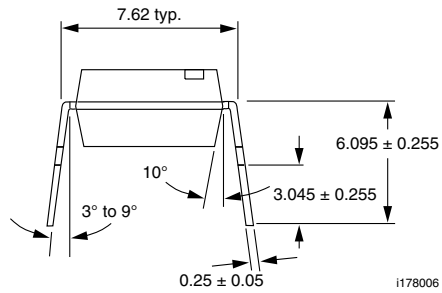
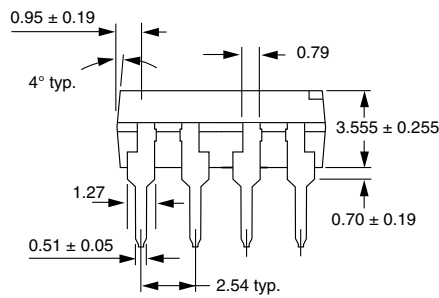
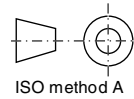
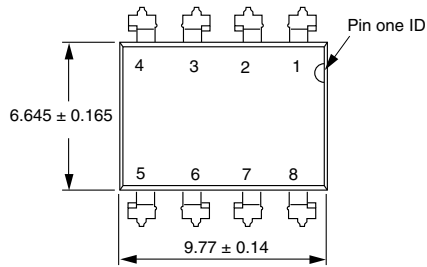


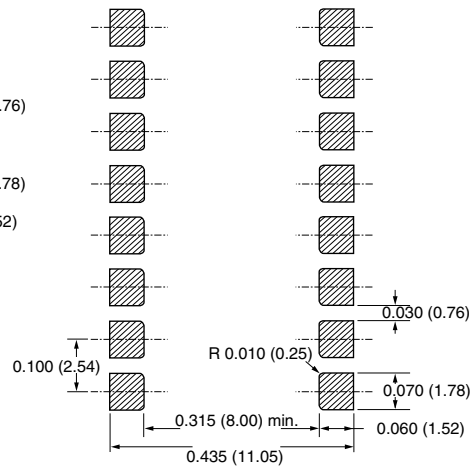
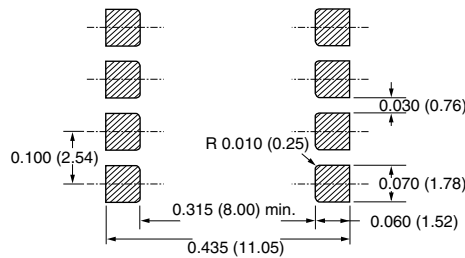
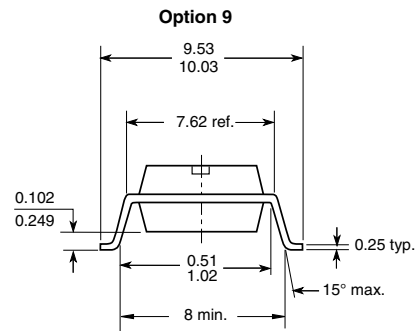
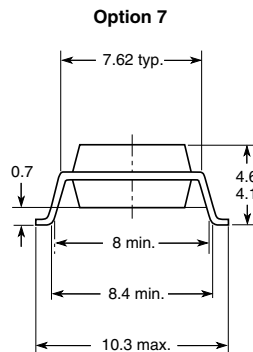
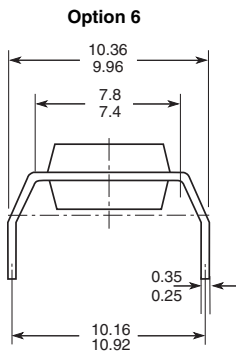
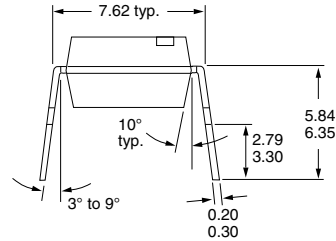
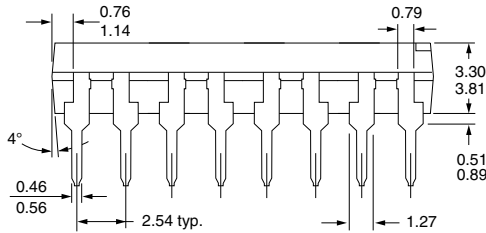
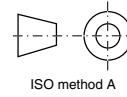
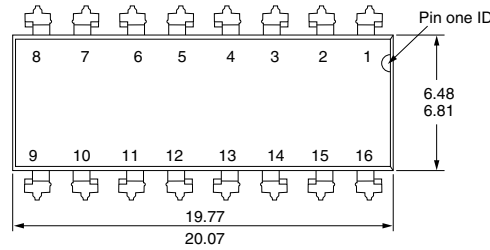
Fig. 14 - Propagation Delay vs. Collector Load Resistor

PACKAGE DIMENSIONS in millimeters



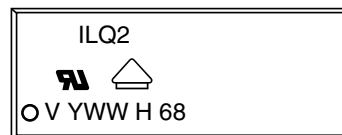
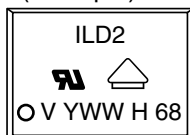


PACKAGE DIMENSIONS in millimeters



18450-9

PACKAGE MARKING (example)



Notes

- Only option 1 and 7 reflected in the package marking
- The VDE logo is only marked on option 1 parts
- Tape and reel suffix (T) is not part of the package marking



Disclaimer

ALL PRODUCT, PRODUCT SPECIFICATIONS AND DATA ARE SUBJECT TO CHANGE WITHOUT NOTICE TO IMPROVE RELIABILITY, FUNCTION OR DESIGN OR OTHERWISE.

Vishay Intertechnology, Inc., its affiliates, agents, and employees, and all persons acting on its or their behalf (collectively, "Vishay"), disclaim any and all liability for any errors, inaccuracies or incompleteness contained in any datasheet or in any other disclosure relating to any product.

Vishay makes no warranty, representation or guarantee regarding the suitability of the products for any particular purpose or the continuing production of any product. To the maximum extent permitted by applicable law, Vishay disclaims (i) any and all liability arising out of the application or use of any product, (ii) any and all liability, including without limitation special, consequential or incidental damages, and (iii) any and all implied warranties, including warranties of fitness for particular purpose, non-infringement and merchantability.

Statements regarding the suitability of products for certain types of applications are based on Vishay's knowledge of typical requirements that are often placed on Vishay products in generic applications. Such statements are not binding statements about the suitability of products for a particular application. It is the customer's responsibility to validate that a particular product with the properties described in the product specification is suitable for use in a particular application. Parameters provided in datasheets and / or specifications may vary in different applications and performance may vary over time. All operating parameters, including typical parameters, must be validated for each customer application by the customer's technical experts. Product specifications do not expand or otherwise modify Vishay's terms and conditions of purchase, including but not limited to the warranty expressed therein.

Except as expressly indicated in writing, Vishay products are not designed for use in medical, life-saving, or life-sustaining applications or for any other application in which the failure of the Vishay product could result in personal injury or death. Customers using or selling Vishay products not expressly indicated for use in such applications do so at their own risk. Please contact authorized Vishay personnel to obtain written terms and conditions regarding products designed for such applications.

No license, express or implied, by estoppel or otherwise, to any intellectual property rights is granted by this document or by any conduct of Vishay. Product names and markings noted herein may be trademarks of their respective owners.

Mouser Electronics

Authorized Distributor

Click to View Pricing, Inventory, Delivery & Lifecycle Information:

[Vishay:](#)

[ILD1](#) [ILD2](#) [ILD2-X007T](#) [ILD2-X009](#) [ILD5](#) [ILQ1](#) [ILQ2](#) [ILQ2-X009](#) [ILQ5](#) [ILD1-X001](#) [ILD1-X007](#) [ILD1-X007T](#) [ILD1-X009](#) [ILD1-X009T](#) [ILD1-X019T](#) [ILD1211T](#) [ILD1213T](#) [ILD1217T](#) [ILD2-X001](#) [ILD2-X006](#) [ILD2-X007](#) [ILD2-X009T](#) [ILD2-X016](#) [ILD2-X017](#) [ILD5-X001](#) [ILD5-X009T](#) [ILQ1-X006](#) [ILQ1-X007](#) [ILQ1-X009](#) [ILQ2-X001](#) [ILQ2-X006](#) [ILQ2-X007](#) [ILQ2-X007T](#) [ILQ2-X009T](#) [ILQ2-X016](#) [ILQ2-X017](#) [ILQ2-X017T](#) [ILQ5-X009](#) [ILQ5-X009T](#) [ILD5-X009](#) [ILQ1-X009T](#) [ILD207-X001T](#)