

Wall Mounting Receptacle

TKJ0

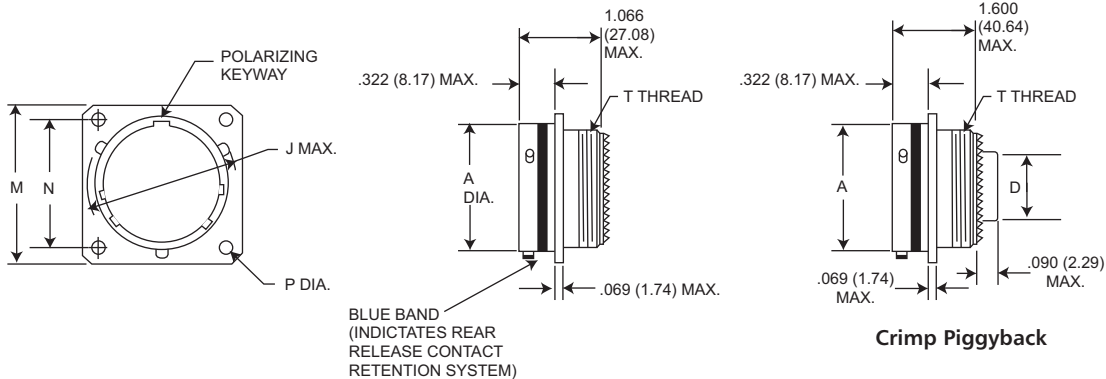

Wall Mounting Receptacle (Back Panel)

TKJ3

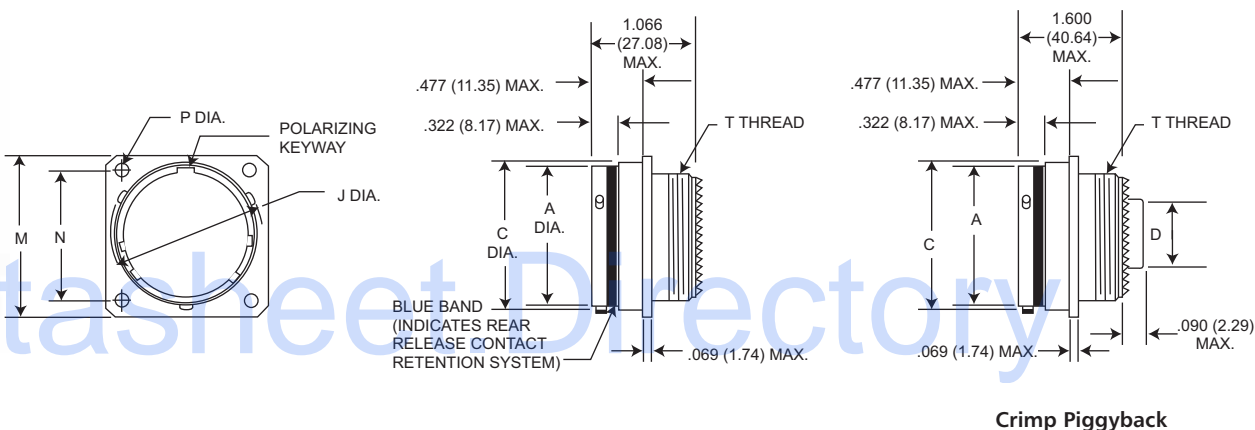

Shell Size	A Dia. Max.	C Dia. Max.	D Dia. Max.	G Dia. Max.	J Dia. Max.	M Max.	N T.P	P +.005 (0.13) - .010 (0.25)	T Thread
8	.474 (12.04)	.547 (13.89)	.299 (7.59)	.562 (14.27)	.563 (14.30)	.828 (21.03)	.594 (15.09)	.125 (3.18)	.5625-24UNEF-2A
10	.591 (15.01)	.672 (17.06)	.427 (10.85)	.594 (15.08)	.680 (17.27)	.954 (24.23)	.719 (18.26)	.125 (3.18)	11/16-24UNEF-2A
12	.751 (19.08)	.844 (21.43)	.541 (13.74)	.720 (18.28)	.859 (21.82)	1.047 (26.59)	.812 (20.62)	.125 (3.18)	13/16-20UNEF-2A
14	.876 (22.25)	.969 (24.61)	.666 (16.92)	.844 (21.43)	.984 (24.99)	1.141 (28.98)	.906 (23.01)	.125 (3.18)	15/16-20UNEF-2A
16	1.001 (25.43)	1.094 (27.78)	.791 (20.09)	.969 (24.61)	1.108 (28.14)	1.234 (31.34)	.969 (24.61)	.125 (3.18)	1-1/16-18UNEF-2A
18	1.126 (28.60)	1.219 (30.96)	.880 (22.35)	1.063 (27.00)	1.233 (31.32)	1.328 (33.73)	1.062 (26.97)	.125 (3.18)	1-1/16-18UNEF-2A
20	1.251 (31.78)	1.344 (34.13)	1.005 (25.52)	1.188 (30.17)	1.358 (34.49)	1.453 (36.91)	1.156 (27.36)	.125 (3.18)	1-3/16-18UNEF-2A
22	1.376 (34.95)	1.469 (37.31)	1.130 (28.70)	1.313 (33.35)	1.483 (37.67)	1.578 (39.08)	1.250 (31.76)	.125 (3.18)	1-5/16-18UNEF-2A
24	1.501 (38.13)	1.594 (40.48)	1.255 (31.88)	1.438 (36.52)	1.610 (40.89)	1.703 (43.26)	1.375 (34.92)	.152 (3.86)	1-7/16-18UNEF-2A

Dimensions shown in inch (mm)
 Specifications and dimensions subject to change

www.ittcannon.com



Box Mounting Receptacle (Back Panel, No Rear Threads)

TKJ5

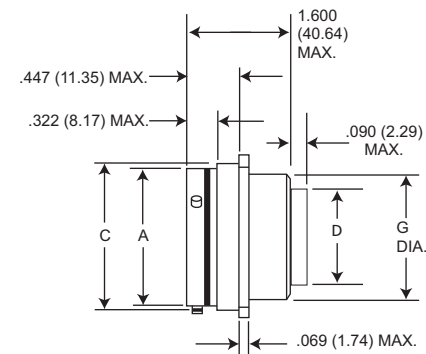
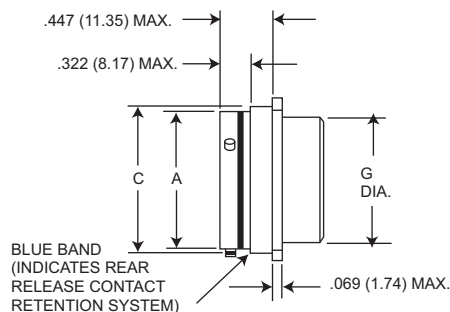
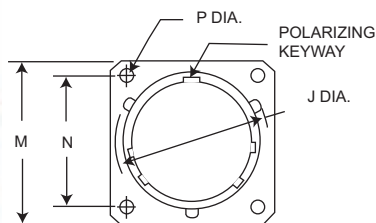

Crimp Piggyback

Shell Size	A Dia. Max.	C Dia. Max.	D Dia. Max.	G Dia. Max.	J Dia. Max.	M Max.	N T.P	P +.005 (0.13) - .010 (0.25)
8	.474 (12.04)	.547 (13.89)	.299 (7.59)	.562 (14.27)	.563 (14.30)	.828 (21.03)	.594 (15.09)	.125 (3.18)
10	.591 (15.01)	.672 (17.06)	.427 (10.85)	.594 (15.08)	.680 (17.27)	.954 (24.23)	.719 (18.26)	.125 (3.18)
12	.751 (19.08)	.844 (21.43)	.541 (13.74)	.720 (18.28)	.859 (21.82)	1.047 (26.59)	.812 (20.62)	.125 (3.18)
14	.876 (22.25)	.969 (24.61)	.666 (16.92)	.844 (21.43)	.984 (24.99)	1.141 (28.98)	.906 (23.01)	.125 (3.18)
16	1.001 (25.42)	1.094 (27.78)	.791 (20.09)	.969 (24.61)	1.108 (28.14)	1.234 (31.24)	.969 (24.61)	.125 (3.18)
18	1.126 (28.60)	1.219 (30.96)	.880 (22.35)	1.063 (27.00)	1.233 (31.32)	1.328 (33.73)	1.062 (26.97)	.125 (3.18)
20	1.251 (31.77)	1.344 (34.13)	1.005 (25.52)	1.188 (30.17)	1.358 (34.49)	1.453 (36.91)	1.156 (29.36)	.125 (3.18)
22	1.376 (34.95)	1.469 (37.31)	1.130 (28.70)	1.313 (33.35)	1.483 (37.67)	1.578 (40.08)	1.250 (31.75)	.125 (3.18)
24	1.501 (38.13)	1.594 (40.48)	1.255 (31.88)	1.438 (36.52)	1.610 (40.89)	1.703 (43.66)	1.375 (34.92)	.152 (3.86)

Jam Nut Receptacle

TKJ7

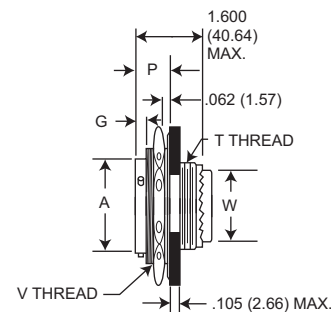
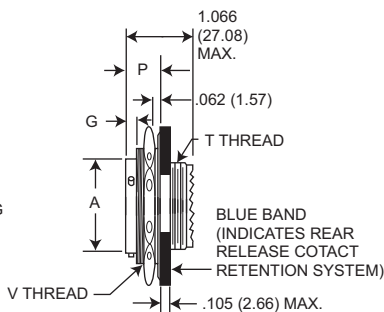
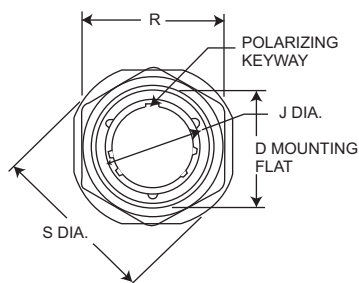

Crimp Piggyback

Shell Size	C Dia. Max.	D Max.	G Max.	J Max.	P Max.	R Max. Hex.	S Dia. Max.	T Thread	V Thread	W Dia. Max.
8	.474 (12.04)	.818 (20.78)	.145 (3.68)	.563 (14.30)	.443 (11.25)	1.079 (27.41)	1.381 (35.08)	.5625-24UNEF-2A	7/8-20UNEF-2A	.299 (7.59)
10	.591 (15.01)	.942 (23.93)	.145 (3.68)	.680 (17.27)	.443 (11.25)	1.205 (30.61)	1.506 (38.25)	11/16-24UNEF-2A	1-20UNEF-2A	.427 (10.85)
12	.751 (19.08)	1.066 (27.08)	.145 (3.68)	.859 (21.82)	.443 (11.25)	1.329 (33.76)	1.631 (41.43)	13/16-20UNEF-2A	1-1/8-18UNEF-2A	.541 (13.74)
14	.876 (22.25)	1.191 (30.25)	.145 (3.68)	.984 (24.99)	.443 (11.25)	1.455 (36.96)	1.756 (44.60)	15/16-20UNEF-2A	1-1/4-18UNEF-2A	.666 (16.92)
16	1.001 (25.43)	1.321 (33.55)	.145 (3.68)	1.108 (28.14)	.443 (11.25)	1.579 (40.11)	1.944 (49.38)	1-1/16-18UNEF-2A	1-3/8-18UNEF-2A	.791 (20.09)
18	1.126 (28.60)	1.441 (36.60)	.145 (3.68)	1.233 (31.32)	.443 (11.25)	1.705 (43.31)	2.022 (51.36)	1-1/16-18UNEF-2A	1-1/2-18UNEF-2A	.880 (22.35)
20	1.251 (31.78)	1.566 (39.78)	.171 (4.34)	1.358 (34.49)	.469 (11.91)	1.829 (46.46)	2.147 (54.53)	1-3/16-18UNEF-2A	1-5/8-18UNEF-2A	1.005 (25.52)
22	1.376 (33.95)	1.691 (42.95)	.171 (4.34)	1.483 (37.67)	.469 (11.91)	2.017 (51.23)	2.271 (57.68)	1-5/16-18UNEF-2A	1-3/4-18UNEF-2A	1.130 (28.70)
24	1.501 (38.13)	1.816 (46.13)	.171 (4.34)	1.610 (40.89)	.469 (11.91)	2.142 (54.41)	2.396 (60.86)	1-7/16-18UNEF-2A	1-7/8-18UNEF-2A	1.255 (31.88)



Dimensions shown in inch (mm)
Specifications and dimensions subject to change

www.ittcannon.com