

Wall Mounting Receptacle

TKJ0

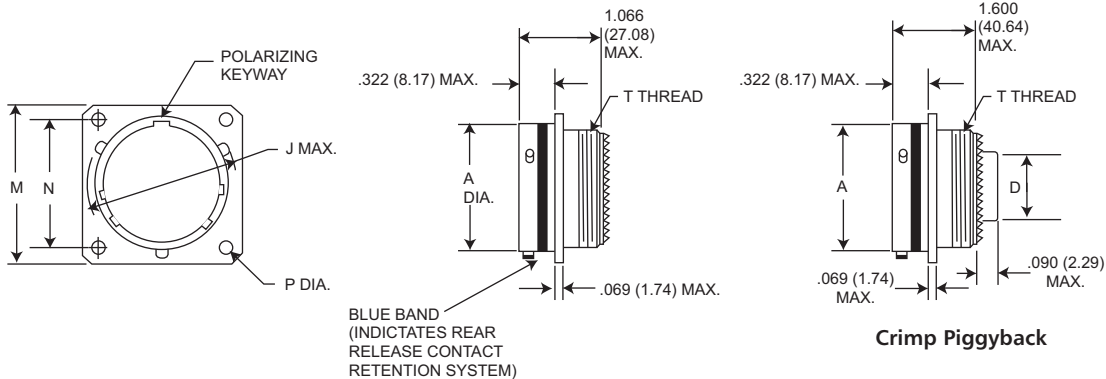

Wall Mounting Receptacle (Back Panel)

TKJ3

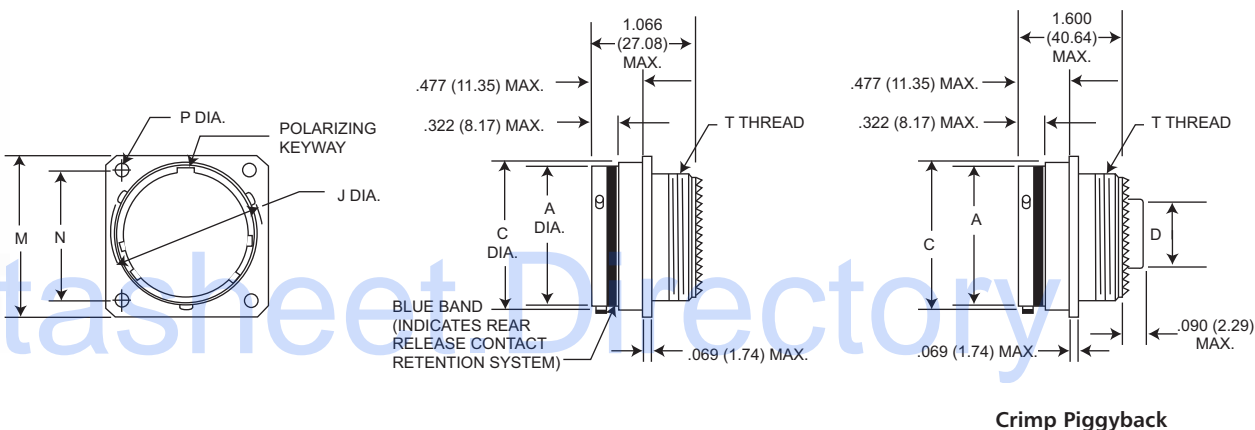

| Shell Size | A Dia. Max. | C Dia. Max. | D Dia. Max. | G Dia. Max. | J Dia. Max. | M Max. | N T.P | P +.005 (0.13) -.010 (0.25) | T Thread |
|------------|---------------|---------------|---------------|---------------|---------------|---------------|---------------|-----------------------------------|------------------|
| 8 | .474 (12.04) | .547 (13.89) | .299 (7.59) | .562 (14.27) | .563 (14.30) | .828 (21.03) | .594 (15.09) | .125 (3.18) | .5625-24UNEF-2A |
| 10 | .591 (15.01) | .672 (17.06) | .427 (10.85) | .594 (15.08) | .680 (17.27) | .954 (24.23) | .719 (18.26) | .125 (3.18) | 11/16-24UNEF-2A |
| 12 | .751 (19.08) | .844 (21.43) | .541 (13.74) | .720 (13.28) | .859 (21.82) | 1.047 (26.59) | .812 (20.62) | .125 (3.18) | 13/16-20UNEF-2A |
| 14 | .876 (22.25) | .969 (24.61) | .666 (16.92) | .844 (21.43) | .984 (24.99) | 1.141 (28.98) | .906 (23.01) | .125 (3.18) | 15/16-20UNEF-2A |
| 16 | 1.001 (25.43) | 1.094 (27.78) | .791 (20.09) | .969 (24.61) | 1.108 (28.14) | 1.234 (31.34) | .969 (24.61) | .125 (3.18) | 1-1/16-18UNEF-2A |
| 18 | 1.126 (28.60) | 1.219 (30.96) | .880 (22.35) | 1.063 (27.00) | 1.233 (31.32) | 1.328 (33.73) | 1.062 (26.97) | .125 (3.18) | 1-1/16-18UNEF-2A |
| 20 | 1.251 (31.78) | 1.344 (34.13) | 1.005 (25.52) | 1.188 (30.17) | 1.358 (34.49) | 1.453 (36.91) | 1.156 (27.36) | .125 (3.18) | 1-3/16-18UNEF-2A |
| 22 | 1.376 (34.95) | 1.469 (37.31) | 1.130 (28.70) | 1.313 (33.35) | 1.483 (37.67) | 1.578 (39.08) | 1.250 (31.76) | .125 (3.18) | 1-5/16-18UNEF-2A |
| 24 | 1.501 (38.13) | 1.594 (40.48) | 1.255 (31.88) | 1.438 (36.52) | 1.610 (40.89) | 1.703 (43.26) | 1.375 (34.92) | .152 (3.86) | 1-7/16-18UNEF-2A |

Dimensions shown in inch (mm)
Specifications and dimensions subject to change

www.ittcannon.com



Box Mounting Receptacle (Back Panel, No Rear Threads)

TKJ5

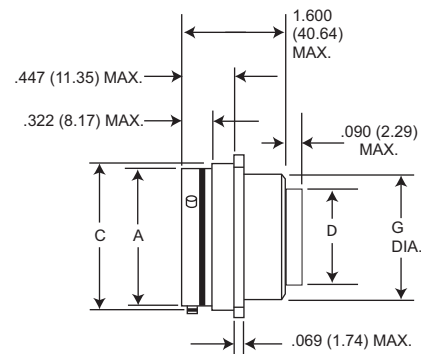
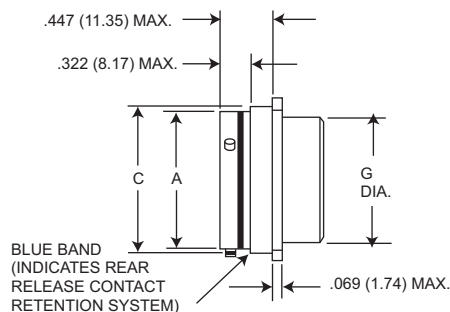
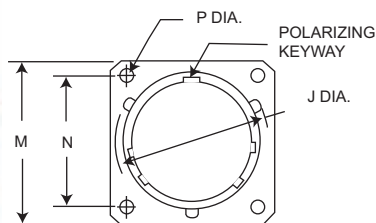

Crimp Piggyback

| Shell Size | A Dia. Max. | C Dia. Max. | D Dia. Max. | G Dia. Max. | J Dia. Max. | M Max. | N T.P | P +.005 (0.13) - .010 (0.25) |
|------------|---------------|---------------|---------------|---------------|---------------|---------------|---------------|------------------------------|
| 8 | .474 (12.04) | .547 (13.89) | .299 (7.59) | .562 (14.27) | .563 (14.30) | .828 (21.03) | .594 (15.09) | .125 (3.18) |
| 10 | .591 (15.01) | .672 (17.06) | .427 (10.85) | .594 (15.08) | .680 (17.27) | .954 (24.23) | .719 (18.26) | .125 (3.18) |
| 12 | .751 (19.08) | .844 (21.43) | .541 (13.74) | .720 (18.28) | .859 (21.82) | 1.047 (26.59) | .812 (20.62) | .125 (3.18) |
| 14 | .876 (22.25) | .969 (24.61) | .666 (16.92) | .844 (21.43) | .984 (24.99) | 1.141 (28.98) | .906 (23.01) | .125 (3.18) |
| 16 | 1.001 (25.42) | 1.094 (27.78) | .791 (20.09) | .969 (24.61) | 1.108 (28.14) | 1.234 (31.24) | .969 (24.61) | .125 (3.18) |
| 18 | 1.126 (28.60) | 1.219 (30.96) | .880 (22.35) | 1.063 (27.00) | 1.233 (31.32) | 1.328 (33.73) | 1.062 (26.97) | .125 (3.18) |
| 20 | 1.251 (31.77) | 1.344 (34.13) | 1.005 (25.52) | 1.188 (30.17) | 1.358 (34.49) | 1.453 (36.91) | 1.156 (29.36) | .125 (3.18) |
| 22 | 1.376 (34.95) | 1.469 (37.31) | 1.130 (28.70) | 1.313 (33.35) | 1.483 (37.67) | 1.578 (40.08) | 1.250 (31.75) | .125 (3.18) |
| 24 | 1.501 (38.13) | 1.594 (40.48) | 1.255 (31.88) | 1.438 (36.52) | 1.610 (40.89) | 1.703 (43.66) | 1.375 (34.92) | .152 (3.86) |

Jam Nut Receptacle

TKJ7

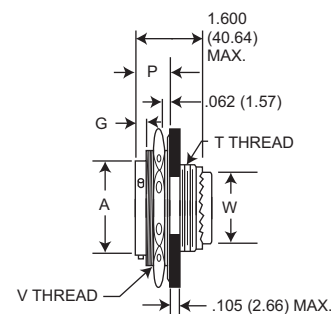
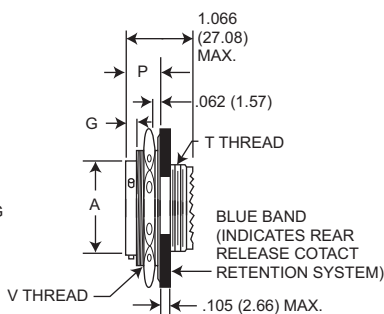
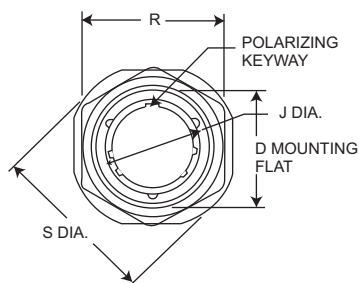

Crimp Piggyback

| Shell Size | C Dia. Max. | D Max. | G Max. | J Max. | P Max. | R Max. Hex. | S Dia. Max. | T Thread | V Thread | W Dia. Max. |
|------------|---------------|---------------|-------------|---------------|--------------|---------------|---------------|------------------|-----------------|---------------|
| 8 | .474 (12.04) | .818 (20.78) | .145 (3.68) | .563 (14.30) | .443 (11.25) | 1.079 (27.41) | 1.381 (35.08) | .5625-24UNEF-2A | 7/8-20UNEF-2A | .299 (7.59) |
| 10 | .591 (15.01) | .942 (23.93) | .145 (3.68) | .680 (17.27) | .443 (11.25) | 1.205 (30.61) | 1.506 (38.25) | 11/16-24UNEF-2A | 1-20UNEF-2A | .427 (10.85) |
| 12 | .751 (19.08) | 1.066 (27.08) | .145 (3.68) | .859 (21.82) | .443 (11.25) | 1.329 (33.76) | 1.631 (41.43) | 13/16-20UNEF-2A | 1-1/8-18UNEF-2A | .541 (13.74) |
| 14 | .876 (22.25) | 1.191 (30.25) | .145 (3.68) | .984 (24.99) | .443 (11.25) | 1.455 (36.96) | 1.756 (44.60) | 15/16-20UNEF-2A | 1-1/4-18UNEF-2A | .666 (16.92) |
| 16 | 1.001 (25.43) | 1.321 (33.55) | .145 (3.68) | 1.108 (28.14) | .443 (11.25) | 1.579 (40.11) | 1.944 (49.38) | 1-1/16-18UNEF-2A | 1-3/8-18UNEF-2A | .791 (20.09) |
| 18 | 1.126 (28.60) | 1.441 (36.60) | .145 (3.68) | 1.233 (31.32) | .443 (11.25) | 1.705 (43.31) | 2.022 (51.36) | 1-1/16-18UNEF-2A | 1-1/2-18UNEF-2A | .880 (22.35) |
| 20 | 1.251 (31.78) | 1.566 (39.78) | .171 (4.34) | 1.358 (34.49) | .469 (11.91) | 1.829 (46.46) | 2.147 (54.53) | 1-3/16-18UNEF-2A | 1-5/8-18UNEF-2A | 1.005 (25.52) |
| 22 | 1.376 (33.95) | 1.691 (42.95) | .171 (4.34) | 1.483 (37.67) | .469 (11.91) | 2.017 (51.23) | 2.271 (57.68) | 1-5/16-18UNEF-2A | 1-3/4-18UNEF-2A | 1.130 (28.70) |
| 24 | 1.501 (38.13) | 1.816 (46.13) | .171 (4.34) | 1.610 (40.89) | .469 (11.91) | 2.142 (54.41) | 2.396 (60.86) | 1-7/16-18UNEF-2A | 1-7/8-18UNEF-2A | 1.255 (31.88) |



Dimensions shown in inch (mm)
Specifications and dimensions subject to change

www.ittcannon.com