

NPN Silicon Darlington Transistors

- For general AF applications
- High collector current
- High current gain
- Pb-free (RoHS compliant) package¹⁾
- Qualified according AEC Q101

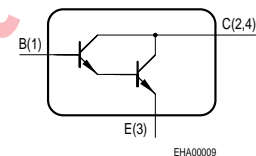
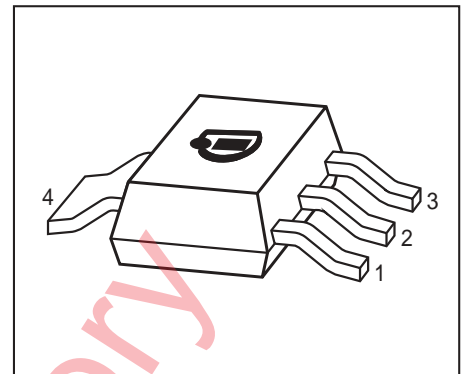

Type	Marking	Pin Configuration				Package
BCP49	BCP 49	1 = B	2 = C	3 = E	4 = C	SOT223

Maximum Ratings

Parameter	Symbol	Values	Unit
Collector-emitter voltage	V_{CEO}	60	V
Collector-base voltage	V_{CBO}	80	
Emitter-base voltage	V_{EBO}	10	
DC collector current	I_C	500	mA
Peak collector current	I_{CM}	800	mA
Base current	I_B	100	
Peak base current	I_{BM}	200	
Total power dissipation, $T_S = 124\text{ °C}$	P_{tot}	1.5	W
Junction temperature	T_j	150	°C
Storage temperature	T_{stg}	-65 ... 150	

Thermal Resistance

Junction - soldering point ²⁾	R_{thJS}	≤17	K/W
--	------------	-----	-----

¹Pb-containing package may be available upon special request

²For calculation of R_{thJA} please refer to Application Note Thermal Resistance

Electrical Characteristics at $T_A = 25^\circ\text{C}$, unless otherwise specified.

Parameter	Symbol	Values			Unit
		min.	typ.	max.	
DC Characteristics					
Collector-emitter breakdown voltage $I_C = 1 \text{ mA}, I_B = 0$	$V_{(BR)CEO}$	60	-	-	V
Collector-base breakdown voltage $I_C = 100 \mu\text{A}, I_E = 0$	$V_{(BR)CBO}$	80	-	-	
Emitter-base breakdown voltage $I_E = 10 \mu\text{A}, I_C = 0$	$V_{(BR)EBO}$	10	-	-	
Collector cutoff current $V_{CB} = 60 \text{ V}, I_E = 0$	I_{CBO}	-	-	100	nA
Collector cutoff current $V_{CB} = 60 \text{ V}, I_E = 0, T_A = 150^\circ\text{C}$	I_{CBO}	-	-	10	μA
Emitter cutoff current $V_{EB} = 5 \text{ V}, I_C = 0$	I_{EBO}	-	-	100	nA
DC current gain 1) $I_C = 100 \mu\text{A}, V_{CE} = 1 \text{ V}$	h_{FE}	2000	-	-	-
DC current gain 1) $I_C = 10 \text{ mA}, V_{CE} = 5 \text{ V}$	h_{FE}	4000	-	-	
DC current gain 1) $I_C = 100 \text{ mA}, V_{CE} = 5 \text{ V}$	h_{FE}	10000	-	-	
DC current gain 1) $I_C = 500 \text{ mA}, V_{CE} = 5 \text{ V}$	h_{FE}	2000	-	-	

1) Pulse test: $t \leq 300 \mu\text{s}$, $D = 2\%$

Electrical Characteristics at $T_A = 25^\circ\text{C}$, unless otherwise specified.

Parameter	Symbol	Values			Unit
		min.	typ.	max.	
DC Characteristics					
Collector-emitter saturation voltage ¹⁾ $I_C = 100\text{ mA}, I_B = 0.1\text{ mA}$	V_{CEsat}	-	-	1	V
Base-emitter saturation voltage 1) $I_C = 100\text{ mA}, I_B = 0.1\text{ mA}$	V_{BEsat}	-	-	1.5	
AC Characteristics					
Transition frequency $I_C = 50\text{ mA}, V_{CE} = 5\text{ V}, f = 100\text{ MHz}$	f_T	-	200	-	MHz
Collector-base capacitance $V_{CB} = 10\text{ V}, f = 1\text{ MHz}$	C_{cb}	-	6.5	-	pF

1) Pulse test: $t \leq 300\mu\text{s}$, $D = 2\%$

Total power dissipation $P_{tot} = f(T_S)$

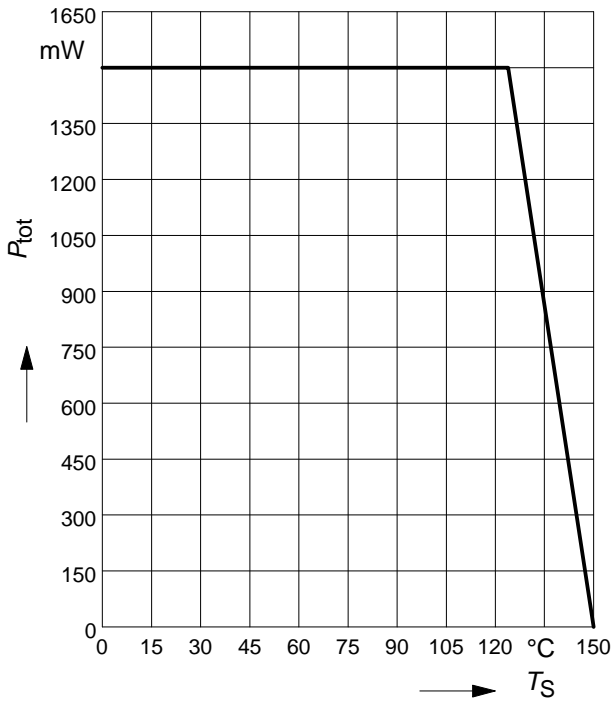

Collector cutoff current $I_{CBO} = f(T_A)$

$V_{CB} = V_{CEmax}$

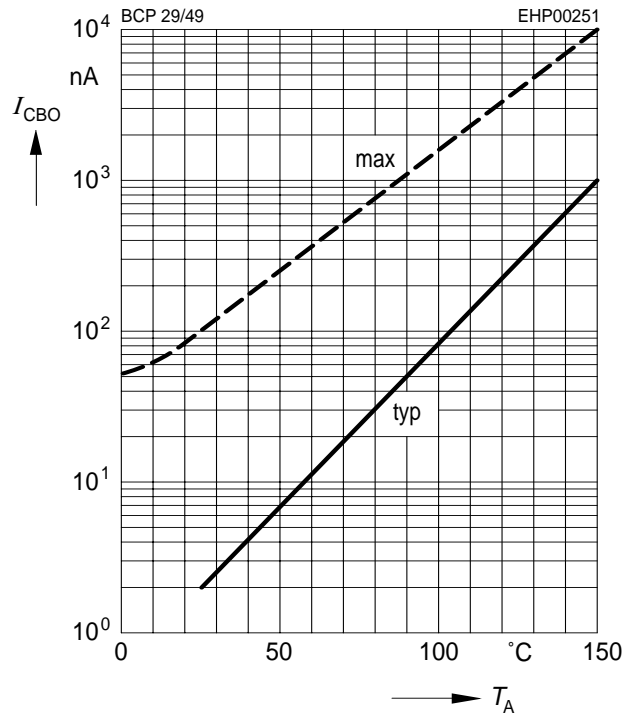

Transition frequency $f_T = f(I_C)$

$V_{CE} = 5V$

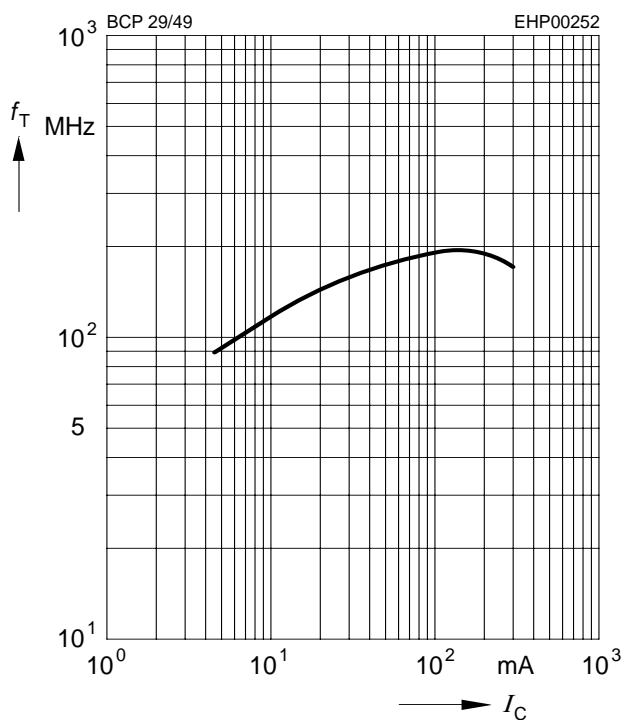

Permissible pulse load

$P_{totmax} / P_{totDC} = f(t_p)$

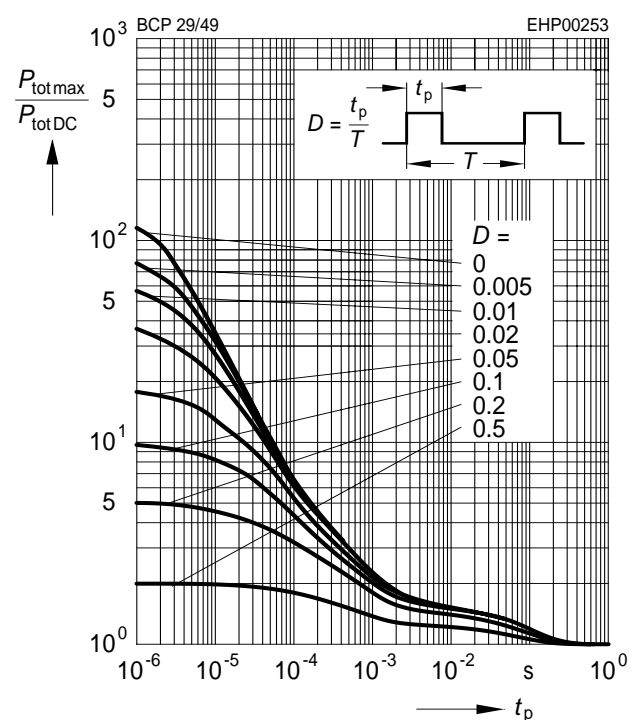

DC current gain $h_{FE} = f(I_C)$

$V_{CE} = 5V$

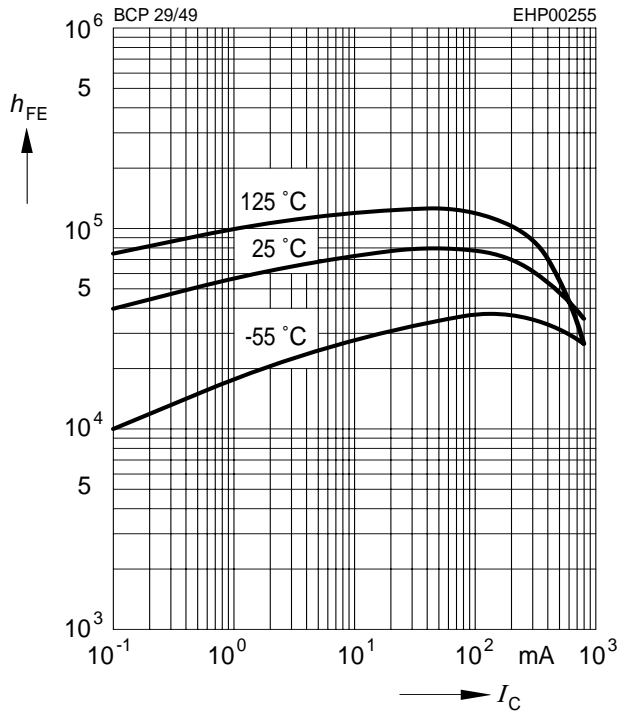

Collector-emitter saturation voltage

$I_C = f(V_{CEsat}), h_{FE} = 1000$

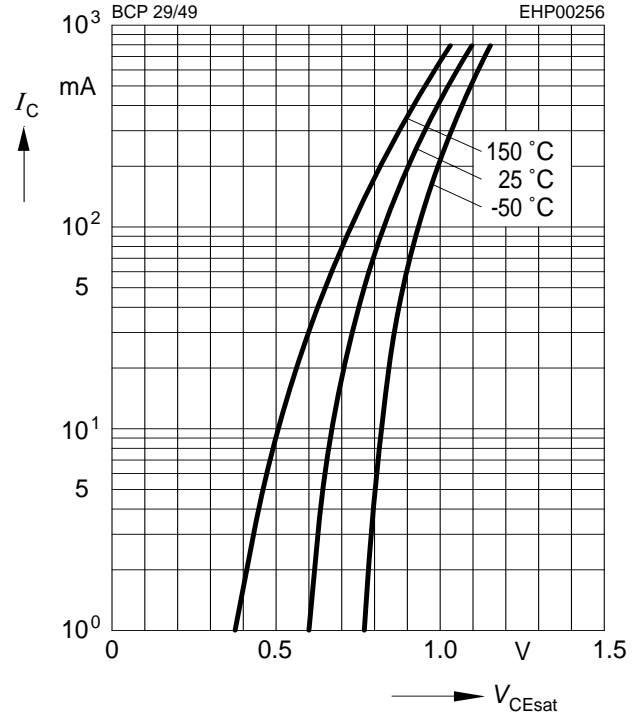

Collector-base capacitance $C_{cb} = f(V_{CB})$

Emitter-base capacitance $C_{eb} = f(V_{EB})$

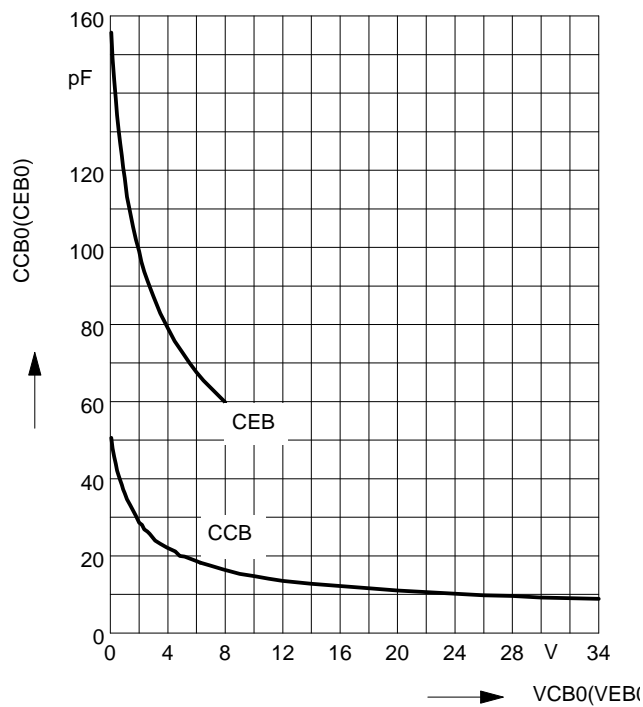

Base-emitter saturation voltage

$I_C = f(V_{BEsat}), h_{FE} = 1000$

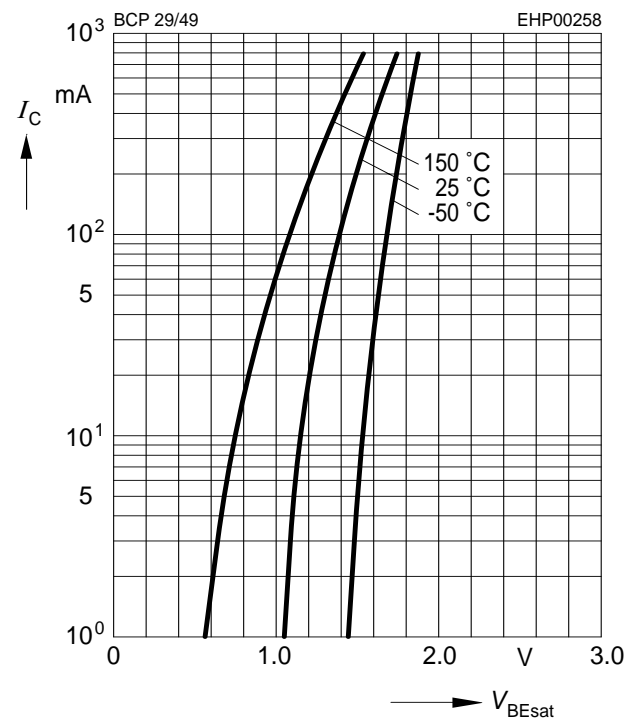

Package Outline

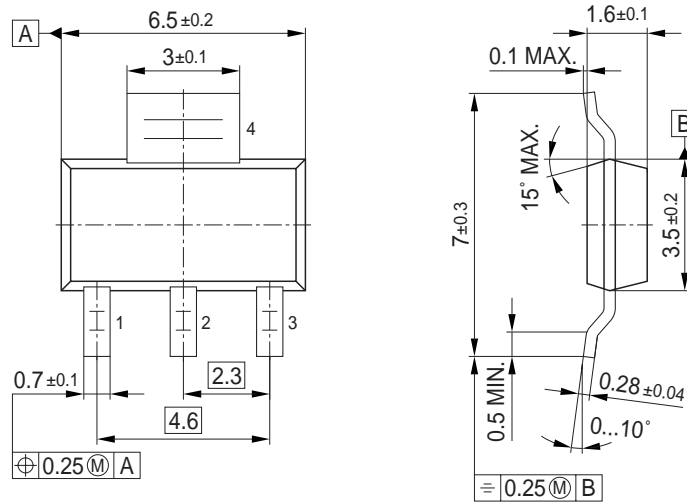

Foot Print

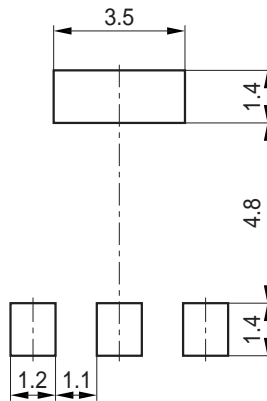

Marking Layout (Example)

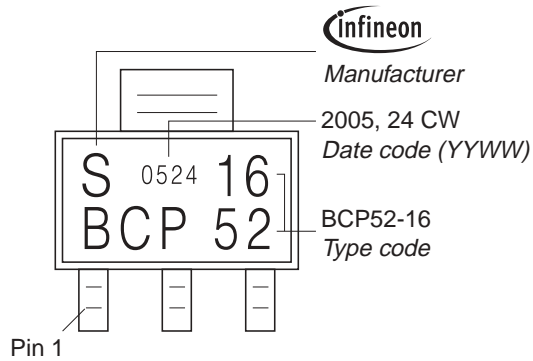

Packing

Reel $\varnothing 180$ mm = 1.000 Pieces/Reel
 Reel $\varnothing 330$ mm = 4.000 Pieces/Reel

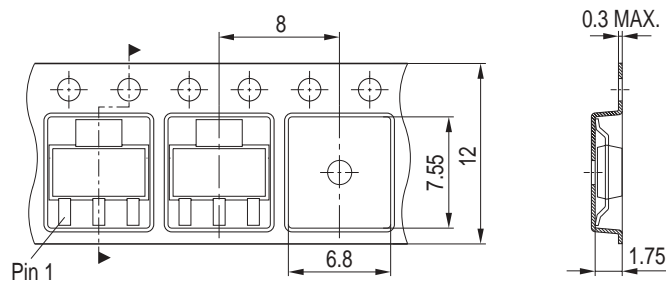

Published by
Infineon Technologies AG
81726 München, Germany
© Infineon Technologies AG 2006.
All Rights Reserved.

Attention please!

The information given in this data sheet shall in no event be regarded as a guarantee of conditions or characteristics ("Beschaffenheitsgarantie"). With respect to any examples or hints given herein, any typical values stated herein and/or any information regarding the application of the device, Infineon Technologies hereby disclaims any and all warranties and liabilities of any kind, including without limitation warranties of non-infringement of intellectual property rights of any third party.

Information

For further information on technology, delivery terms and conditions and prices please contact your nearest Infineon Technologies Office (www.infineon.com).

Warnings

Due to technical requirements components may contain dangerous substances. For information on the types in question please contact your nearest Infineon Technologies Office.

Infineon Technologies Components may only be used in life-support devices or systems with the express written approval of Infineon Technologies, if a failure of such components can reasonably be expected to cause the failure of that life-support device or system, or to affect the safety or effectiveness of that device or system.

Life support devices or systems are intended to be implanted in the human body, or to support and/or maintain and sustain and/or protect human life. If they fail, it is reasonable to assume that the health of the user or other persons may be endangered.