

# AVX

A KYOCERA GROUP COMPANY

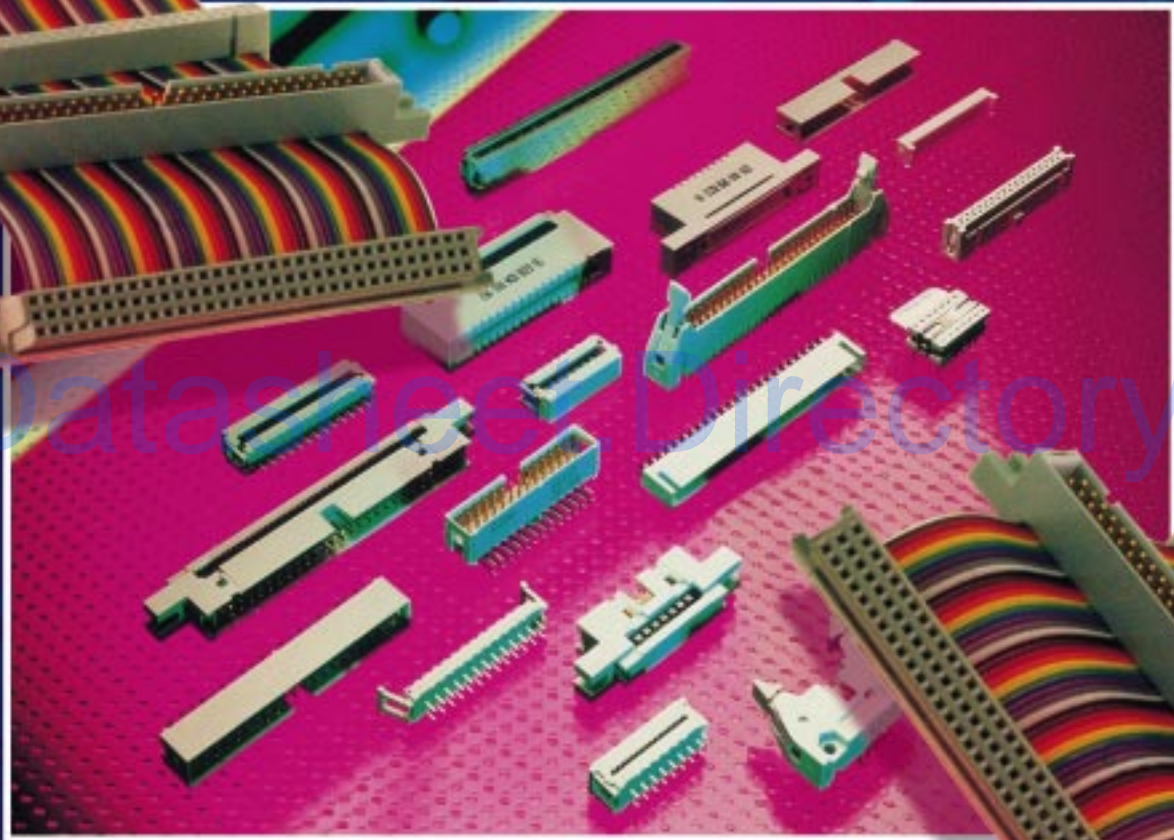

ELCO  
IDC For Round  
Conductor Flat Cable

Introduction - Your Complete IDC Connector Source . . . . .	2-4
Ribbon Cable for IDC Applications . . . . . Series 2026 . . . . .	5
IDC Card Edge Connector . . . . . Series 6338 . . . . .	6-7
Low Profile IDC Dip Plug . . . . . Series 8291 . . . . .	8-9
Single Row IDC Header . . . . . Series 8284 . . . . .	10
Single Row IDC Socket. . . . . Series 8284 . . . . .	11
Ejector Style Header . . . . . Series 8289 . . . . .	12-13
Low Profile IDC Socket Connector . . . . . Series 8290 . . . . .	14-15
IDC Transition Connector . . . . . Series 8292 . . . . .	16-17
Male IDC Plug Connector . . . . . Series 8293 . . . . .	18-19
Low Profile Box Header . . . . . Series 8380 . . . . .	20-21
High Temperature Box Header . . . . . Series 8383 . . . . .	22-23
Dual In-Line IDC Transition Connector . . . . . Series 8399 . . . . .	24-25
DIN 41612 IDC Connector. . . . . Series 8459 . . . . .	26
Customer Application Tooling . . . . .	27

## Connector Approvals



File No. E90723



File No. 1255749

### Series

8289	IDC P.C.B. Header
8290	IDC Socket Connector
8291	IDC Dip Connector
8292	IDC Transition Connector (Staggered)
6338	IDC Card Edge Connector
8399	IDC Transition Connector (Dual In-Line)
8380	Low Profile Box Header

UL Wiring Harness - 764 File No.  
E137836 IDC Cable Assemblies

### Series

8289	IDC P.C.B. Header
8290	IDC Socket Connector
8291	IDC Dip Connector
8292	IDC Transition Connector (Staggered)
6338	IDC Card Edge Connector
8399	IDC Transition Connector (Dual In-Line)
8380	Low Profile Box Header

NOTICE: Specifications are subject to change without notice. Contact your nearest AVX Sales Office for the latest specifications. All statements, information and data given herein are believed to be accurate and reliable, but are presented without guarantee, warranty, or responsibility of any kind, expressed or implied. Statements or suggestions concerning possible use of our products are made without representation or warranty that any such use is free of patent infringement and are not recommendations to infringe any patent. The user should not assume that all safety measures are indicated or that other measures may not be required. Specifications are typical and may not apply to all applications.

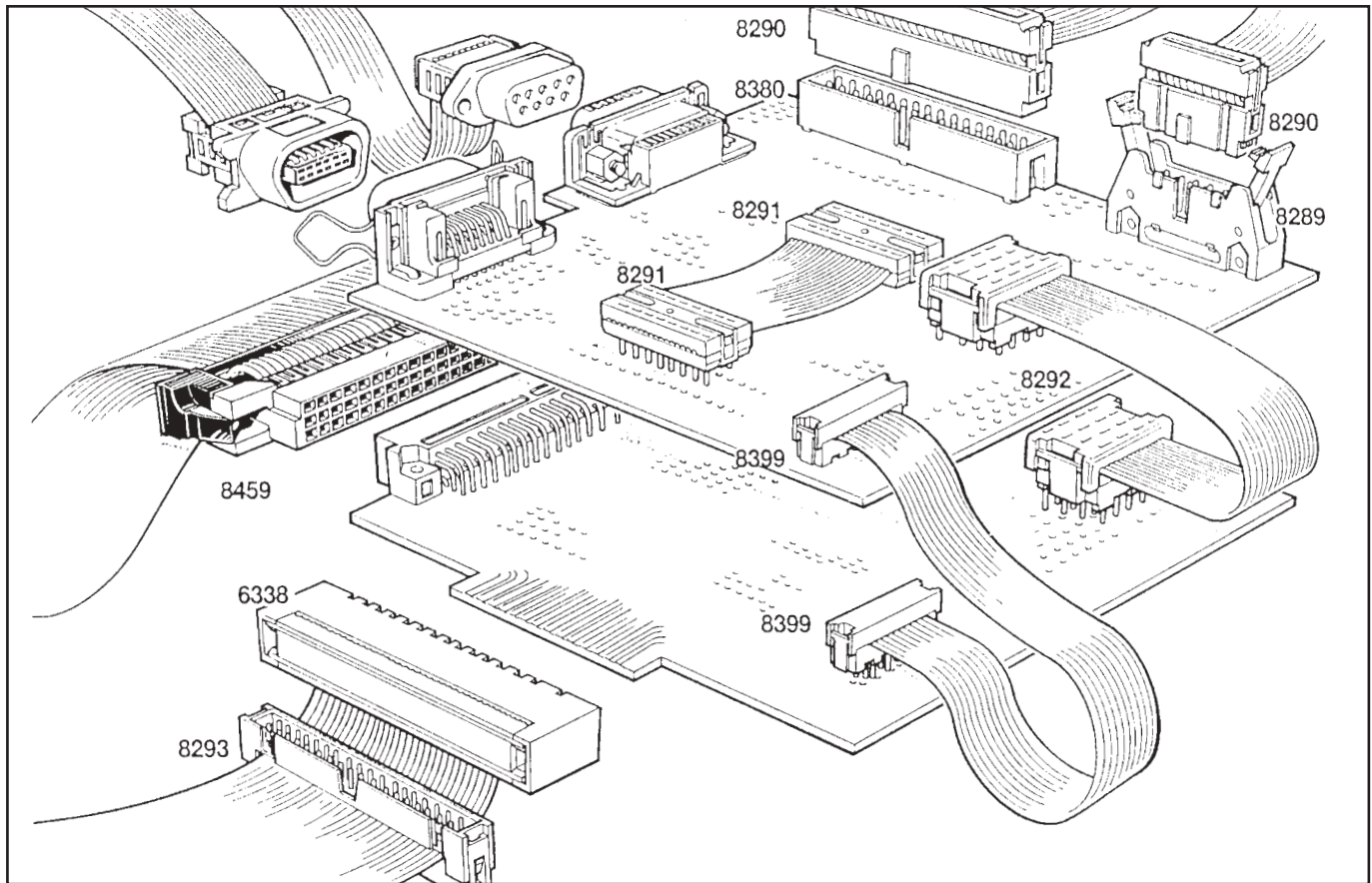

Elco is approved by B.S.I. to B.S.E.N. ISO 9001 to manufacture a broad line of popular IDC connector configurations for a wide variety of applications:

- Telecommunications
- Computers & Peripherals
- Consumer & Business/Office Equipment
- Robotics
- Terminals
- Appliances
- Automotive Electronics
- Military & Aerospace Equipment

### BENEFITS OF FLAT CABLE MASS TERMINATION

- Space efficient and easy to route in tight enclosures
- Easy, fast and reliable termination, with controlled centerline spacing
- Reliable coplanarity provides accurate spacing from #1 to last conductor
- No need for wire stripping, prepping or soldering
- Operators easily trained, to achieve minimal error or variability

And any other cable-to-board, board-to-board and cable-to-cable interface on 0.050" - (1.27mm) and 0.100" (2.54mm) spacing!



# Your Complete IDC Connector Source

## IDC FOR 0.050" (1.27mm) ROUND CONDUCTOR FLAT CABLE

No. of Positions	Socket	Header Latched	Low Profile Header		Card Edge	2 Row Transition	4 Row Transition	DIL Plug	Male Plug	IDC DIN 41612
	Series 8290	Series 8289	Series 8380	Series 8383 High Temp	Series 6338	Series 8399	Series 8292	Series 8291	Series 8293	Series 8459
4										
6				○						
8				●						
9										
10	●	●	●	●	●	●	●		●	
12										
14	●	●	●	●		●		●	●	
15										
16	●	●	●	●	●	●	●	●	●	
20	●	●	●	●	●	●	●		●	
24										
25										
26	●	●	●	●	●	●	●		●	
30										
32										●
34	●	●	●	●	●	●	●		●	
36			●	●						
37										
40	●	●	●	●	●	●	●		●	
44	●				●					
50	●	●	●	●	●	●	●		●	
52										
56										
60	●	●	●	●	●	●	●		●	
64	●	●	●	●		●				●
<b>Accessories</b>										
Strain Relief	●				●	●			●	●
Coding Key	●		●	●						
Polarizing Key		●			●				●	
Latch / Eject	●	●							○	
<b>Tooling</b>										
Base Plate	●				●	●	●	●	●	●
Hand Tool	●				●	●	●	●	○	
Bench Press	●				●	●	●	●	●	●
Semi-Automatic	●				●	●				
Fully Automatic	●				○	○				
<b>Options</b>										
PCB Retention	○	○	○	○		○				

Available ● Consult Sales ○

## IDC FOR 0.100" (2.54mm) ROUND CONDUCTOR FLAT CABLE

No. of Positions	Socket	Header
	Series 8284	Series 8284
8	●	●
14	●	●
16	●	●
18	●	●
20	●	●
24	●	●

## COMPATIBILITY & APPROVALS

- UL
- CSA
- Intermateable and interchangeable with many other manufacturers
- Compatible with MIL-83503 product

### ADVANCED DESIGN & QUALITY

- Contact design pierces the cable insulation, providing a reliable gas-tight termination, with positive electrical characteristics
- Contacts accommodate solid or stranded wire
- Single beam contact face makes early contact with mating pin to give maximum contact wipe
- Industry-standard P.C.B. footprints provide easy circuit routing and efficient use of board real estate
- Popular header variations, such as press-fit, straight (vertical) and right-angle (horizontal) through-hole, for a variety of board thicknesses
- Headers in 4-wall configurations for pin protection

### A FULL RANGE OF FEATURES AND ACCESSORIES

- Lock & ejects that can accommodate sockets with or without strain relief mechanisms, to avoid stressing cable terminations
- Feed-through or closed-end sockets accommodate daisy chain or cable-end applications
- Ridged covers and marked #1 contact positions that provide accurate cable to contact alignment
- S.M.T. header styles molded in high thermal resistant material
- IDC connectors are available in packaging designed for automated cable or P.C.B. assembly

### IDC HARNESSSES

Elco provides custom harness design and manufacturing expertise across a broad range of applications including telecommunications, computing, industrial processing and automotive.

Elco works closely with major manufacturers not just as a supplier of IDC connectors and cable assemblies but as a partner with its own design team working with the customer to solve interconnect problems.

Harness design and manufacture is a strategic growth area for Elco.

### CABLE HARNESSING ASSEMBLY SERVICE

The Company now has the in-house capability to produce IDC cable assemblies for the high volume personal computer and telecommunications market and the market for process instrumentation. Other examples of harnesses are built around the advanced range of VARICON™ connector systems using crimp and solder discrete wiring techniques.

Design of connectors and harnesses are drafted in house using the latest range of CAD equipment.

The Company's quality management system is approved by QS 9000, ensuring optimum reliability.

The Customer profile for cable harnesses substantiates Elco's reputation for total commitment to quality, service and value. The Company's team of interconnection specialists provide Customers with the optimum, most cost-effective interconnection solution.

# Card Edge Connector



## Series 6338

UL Approved File No. E90732.

CSA Approved File No. 1255749.

10, 16, 20, 26, 34, 40, 44, 50 & 60 positions.

Copper alloy contacts.

Accepts printed circuit boards of 1.6mm thickness.

Compatible with other leading manufacturers.



## TECHNICAL SPECIFICATION

### Material:

Molding - UL94VO rated glass filled grey polyester

Contact - Phosphor bronze

### Contact Plating:

Contacts are selective gold-plated over nickel, reflow tin lead on IDC section

### Current Rating:

1 ampere at 70°C maximum ambient

### Working Voltage:

350V DC or AC peak

### Insulation Resistance:

>1000 megohms

### Voltage Proof:

1050 DC or AC peak

### Operating Temperature:

-55°C to +105°C

### Wire Gauge:

26 AWG Solid & Stranded  
28 AWG Solid & Stranded

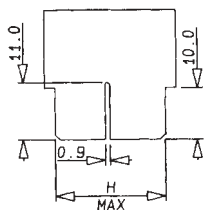

PC CARD DETAILS

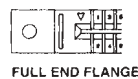

FULL END FLANGE

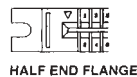

HALF END FLANGE

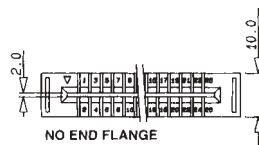

NO END FLANGE

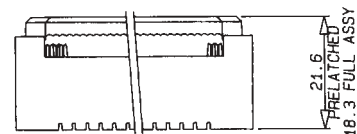
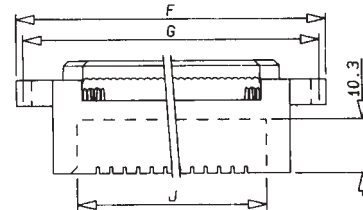
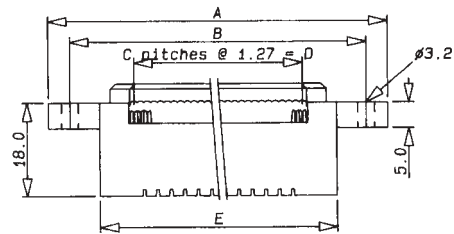

## DIMENSIONS: millimeters (inches)

No. of Positions	A	B	C	D	E	F	G	H	J
010	43.69 (1.72)	35.56 (1.40)	(9)	11.43 (0.450)	24.36 (0.959)	38.10 (1.50)	33.02 (1.30)	15.11 (0.595)	15.34 (0.604)
016	51.31 (2.02)	43.18 (1.70)	(15)	19.05 (0.750)	31.98 (1.26)	45.72 (1.80)	40.64 (1.60)	22.73 (0.895)	22.96 (0.904)
020	56.39 (2.22)	48.26 (1.90)	(19)	24.13 (0.950)	37.06 (1.46)	50.80 (2.00)	45.72 (1.80)	27.81 (1.09)	28.04 (1.10)
026	64.01 (2.52)	55.88 (2.20)	(25)	31.75 (1.25)	44.68 (1.76)	58.42 (2.30)	53.34 (2.10)	35.43 (1.39)	35.66 (1.40)
034	74.17 (2.92)	66.04 (2.60)	(33)	41.91 (1.65)	54.84 (2.16)	68.58 (2.70)	63.50 (2.50)	45.59 (1.79)	45.82 (1.80)
040	81.79 (3.22)	73.66 (2.90)	(39)	49.53 (1.95)	62.46 (2.46)	76.20 (3.00)	71.12 (2.80)	53.21 (2.09)	53.44 (2.10)
044	86.87 (3.42)	78.74 (3.10)	(43)	54.61 (2.15)	67.54 (2.66)	81.28 (3.20)	76.20 (3.00)	58.29 (2.29)	58.52 (2.30)
050	94.49 (3.72)	86.36 (3.40)	(49)	62.23 (2.45)	75.16 (2.96)	88.90 (3.50)	83.82 (3.30)	65.91 (2.59)	66.14 (2.60)
060	107.19 (4.22)	99.06 (3.90)	(59)	74.93 (2.95)	87.86 (3.46)	101.60 (4.00)	96.52 (3.80)	78.61 (3.09)	78.84 (3.10)

# Card Edge Connector

## Series 6338



### CUSTOMER APPLICATION TOOLING

A standard hand press set and platen is available. See page 27.

### POLARIZING KEYS

**Order Code:** 60 6338 4404 00 000 (between contacts)

### ORDERING CODE

<b>00</b>	<b>6338</b>	<b>016</b>	<b>000</b>	<b>02</b>	<b>2</b>
Connector Code Prefix	Series Number	Number of Circuits	Strain Relief	Plating	Variation Insulator End Flanges
		010 = 10 position 016 = 16 position 020 = 20 position 026 = 26 position 034 = 34 position 040 = 40 position 044 = 44 position 050 = 50 position 060 = 60 position	000 = Without strain relief*	02 = Selective Plating 30µ Gold 04 = Selective Plating 10µ Gold	0 = No end flanges 1 = Half end flanges 2 = Full end flanges

NB: \*For optional strain relief version, please contact the local sales office.



# Single Row IDC Header

## Series 8284

IDC header/socket for 0.100" (2.54mm) pitch IDC for 0.100" (2.54mm) round conductor flat cable uses similar 8289/8290 contact components recognized under UL & CSA specifications, but housed in a single row insulator format. The header is a 1-piece insulator with right angle, straight solder or press-fit terminations. The socket is a 2-piece insulator design with IDC contacts suitable for termination to 26/28 AWG stranded ribbon cable or dip solder terminations.



### TECHNICAL SPECIFICATION

<p><b>Material:</b> Molding - UL94VO rated grey polyester Contact - Brass</p> <p><b>Current Rating:</b> 1.5 Amp maximum at 25°C 1 Amp maximum at 70°C</p> <p><b>Insulation Resistance:</b> 1000 megohms</p>	<p><b>Dielectric Withstanding Voltage:</b> 1050V DC or AC peak</p> <p><b>Voltage Rating:</b> 350V DC or AC peak</p> <p><b>Contact Resistance:</b> 20 milliohms maximum</p> <p><b>Operating Temperature:</b> -55°C to +125°C</p>	<p><b>Mechanical Endurance:</b> Standard tin plating - 10 cycles</p> <p><b>Insertion/Withdrawal Forces:</b> 2.7N max insertion force per contact 0.2N min withdrawal force per contact</p>
---	---	--

### CUSTOMER APPLICATION TOOLING

A standard hand press set and platen is available. See page 27.

### HEADER

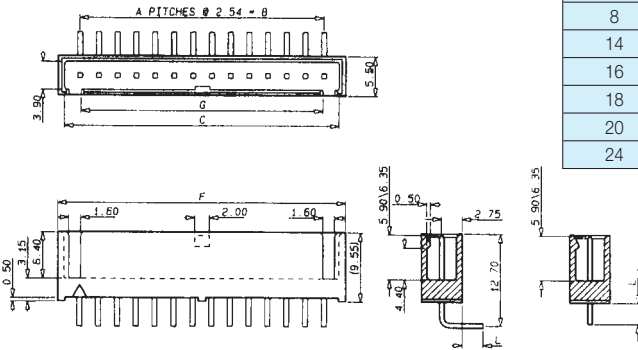

### DIMENSIONS: millimeters (inches)

No. of Positions	A	B	C	D	E	F	G
8	7	17.78 (0.70)	21.30 (0.84)	18.54 (0.73)	19.30 (0.76)	23.70 (0.93)	17.54 (0.69)
14	13	33.02 (1.30)	36.54 (1.44)	33.78 (1.33)	34.54 (1.36)	38.94 (1.53)	32.78 (1.29)
16	15	38.10 (1.50)	42.22 (1.66)	38.86 (1.53)	39.62 (1.56)	44.02 (1.73)	37.86 (1.49)
18	17	43.18 (1.70)	46.70 (1.84)	43.94 (1.73)	44.70 (1.76)	49.10 (1.93)	42.94 (1.69)
20	19	48.26 (1.90)	52.38 (2.06)	49.02 (1.93)	49.78 (1.96)	54.18 (2.13)	48.02 (1.89)
24	23	58.42 (2.30)	61.94 (2.44)	59.18 (2.33)	59.94 (2.36)	64.34 (2.53)	58.18 (2.29)

### ORDERING CODE

<p><b>10</b></p> <p>┆</p> <p><b>Connector Code Prefix</b></p> <p>10 = Header Connector</p>	<p><b>8284</b></p> <p>┆</p> <p><b>Series Number</b></p>	<p><b>014</b></p> <p>┆</p> <p><b>Number of Contacts</b></p> <p>008 = 8 position 014 = 14 position 016 = 16 position 018 = 18 position 020 = 20 position 024 = 24 position</p>	<p><b>000</b></p> <p>┆</p> <p><b>Contact Variation</b></p> <p>000 = 0.110" (2.8mm) Straight PC Tail 001 = 0.146" (3.7mm) Straight PC Tail 002 = 0.110" (2.8mm) R.A. PC Tail 003 = 0.146" (3.7mm) R.A. PC Tail 009 = 0.209" (4.5mm) Straight PC Tail</p>	<p><b>030</b></p> <p>┆</p> <p><b>Plating Variation</b></p> <p>030 = Tin plating, 10 cycles 040 = Gold plating, 50 cycles</p>
--	---	---	---	--



# Single Row IDC Socket



## Series 8284

IDC header/socket for 0.100" (2.54mm) pitch IDC for 0.100" (2.54mm) round conductor flat cable uses similar 8289/8290 contact components recognized under UL & CSA specifications, but housed in a single row insulator format. The header is a 1-piece insulator with right angle, straight solder or press-fit terminations. The socket is a 2-piece insulator design with IDC contacts suitable for termination to 26/28 AWG stranded ribbon cable or dip solder terminations.



### TECHNICAL SPECIFICATION

**Material:**

Molding - UL94VO rated grey polyester  
Contact - Phosphor bronze

**Current Rating:**

1.5 Amp maximum at 25°C  
1 Amp maximum at 70°C

**Insulation Resistance:**

1000 megohms

**Dielectric Withstanding Voltage:**

1050V DC or AC peak

**Voltage Rating:**

350V DC or AC peak

**Contact Resistance:**

20 milliohms maximum

**Operating Temperature:**

-55°C to +125°C

**Mechanical Endurance:**

Standard tin plating - 10 cycles

**Insertion/Withdrawal Forces:**

2.7N max insertion force per contact  
0.2N min withdrawal force per contact

### CUSTOMER APPLICATION TOOLING

A standard hand press set and platen is available.  
See page 27.

### SOCKET

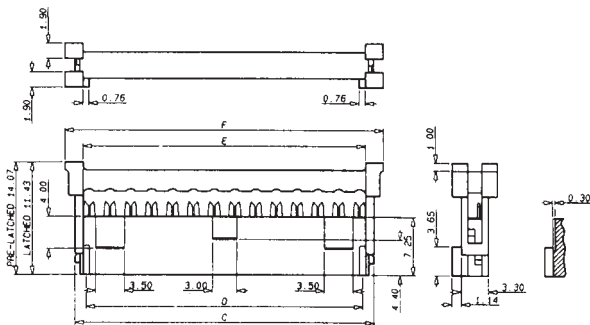

**DIMENSIONS:** millimeters (inches)

No. of Positions	A	B	C	D	E	F
8	7	17.78 (0.70)	21.30 (0.84)	18.54 (0.72)	19.30 (0.76)	23.70 (0.93)
14	13	33.02 (1.18)	36.54 (1.45)	33.78 (1.33)	34.54 (1.36)	38.94 (1.53)
16	15	38.10 (1.50)	42.22 (1.66)	38.86 (1.53)	39.62 (1.56)	44.02 (1.73)
18	17	43.18 (1.70)	46.70 (1.84)	43.94 (1.73)	44.70 (1.76)	49.10 (1.93)
20	19	48.26 (1.90)	52.38 (2.06)	49.02 (1.93)	49.78 (1.96)	54.18 (2.13)
24	23	58.42 (2.30)	61.94 (2.44)	59.18 (2.33)	59.94 (2.36)	64.34 (2.53)

### ORDERING CODE

**20**

**Connector Code Prefix**

20 = Socket Connector

**8284**

**Series Number**

**014**

**Number of Contacts**

008 = 8 position  
014 = 14 position  
016 = 16 position  
018 = 18 position  
020 = 20 position  
024 = 24 position

**000**

**Contact Variation**

000 = Standard IDC contact 26/28 AWG

**030**

**Plating Variation**

030 = Tin plating, 10 cycles  
040 = Gold plating, 50 cycles

# Ejector Style Header



## Series 8289

Available in industry standard sizes of 10-64 positions, they mate to Elco Series 8290 IDC sockets, as well as other industry compatible connectors. Solder or press-fit contacts are available in either straight or right angle formats. The four wall design and optional molded in polarizing keys ensure positive polarization without pin loss. Latch/eject levers can also be specified to suit the mating Series 8290 socket, either with or without strain relief. Stand-off are incorporated to facilitate flux washing and de-gassing.



### TECHNICAL SPECIFICATION

**Material:**

Molding - UL94VO rated glass filled grey polyester

Contact - Phosphor bronze

**Contact Plating:**

Selective gold over nickel plating on the mating face, reflow tin lead IDC section

**Latch/Eject Levers****Part Numbers when ordered separately.**

Long (For 8290 socket with strain relief) 60 8289 6301 00 000  
Short (For 8290 socket without strain relief) 60 8289 6302 00 000

**Current Rating:**

1 ampere at 70°C maximum ambient

**Voltage Rating:**

350V DC or AC peak

**Contact Resistance:**

Initially 10 milliohms maximum

**Dielectric Withstanding Voltage:**

1050 DC or AC peak

**Insulation Resistance:**

>1000 megohms

**Operating Temperature:**

-55°C to +125°C

**UL File No.** E90723

**CSA File No.** 1255749

### ORDERING CODE

<b>00</b>	<b>8289</b>	<b>050</b>	<b>002</b>	<b>1</b>	<b>1</b>	<b>1</b>
<b>Connector Code Prefix</b>	<b>Series Number</b>	<b>Number of Contacts</b>	<b>Contact Termination</b>	<b>Latch/Eject Lever</b>	<b>Plating</b>	<b>Polarization</b>
00 = Standard		010 = 10 position 014 = 14 position 016 = 16 position 020 = 20 position 026 = 26 position 034 = 34 position 040 = 40 position 050 = 50 position 060 = 60 position 064 = 64 position	002 = Straight PC Tail for 2.4mm PCB - 0.142" (3.60mm) 004 = Right Angle PC Tail for 2.4mm PCB - 0.142" (3.60mm) 006 = Straight PC Tail for 1.6mm PCB - 0.110" (2.80mm) 007 = Right Angle PCB Tail for 1.6mm PCB - 0.110" (2.80mm) 009 = Press-Fit PC Tail 2.4/3.2mm PCB - 0.209" (4.5mm)	0 = No Latch/Eject Lever 1 = Latch/Eject Lever for use with Series 8290 with strain relief 2 = Latch/Eject Lever for use with Series 8290 without strain relief	1 = Selective Plating 30µ" Gold over Nickel 4 = Selective Plating 10µ" Gold over Nickel	1 = Type A BS9525 & BT224 Dual Height molding in polarizing key/keys 3 = No Polarizing key/keys - Standard

# Ejector Style Header



## Series 8289

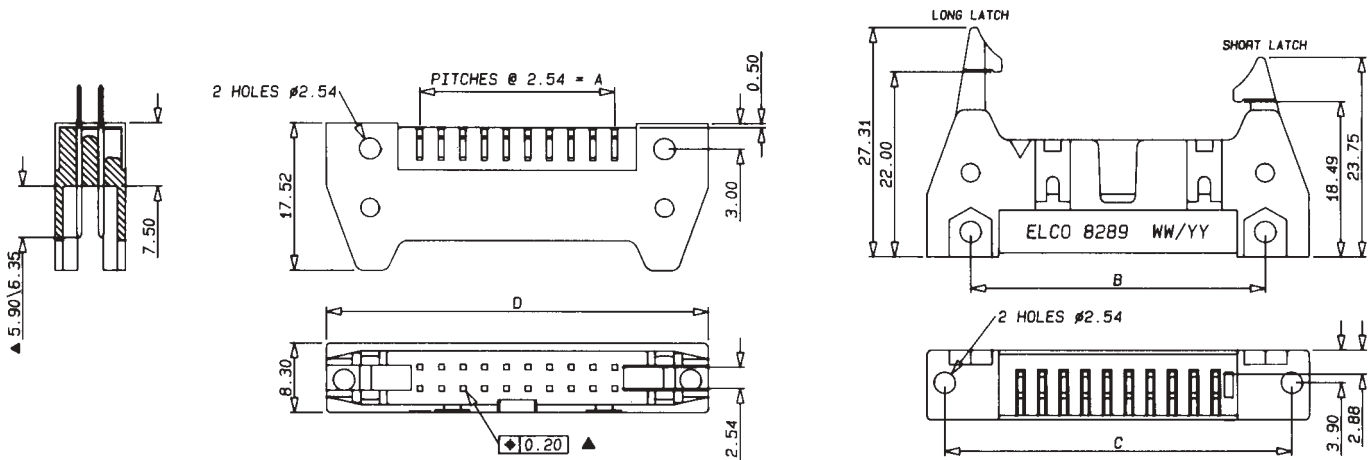

### CONTACT VARIATIONS

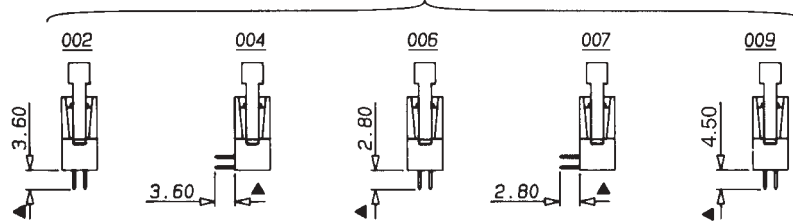

TAIL LENGTH TOLERANCES STANDARD  $\pm 0.30$ mm.

▲  $\pm 0.20$  POSITIONAL TOLERANCE OF TAILS

### BOARD HOLE DETAILS

VIEWED FROM PIN SIDE

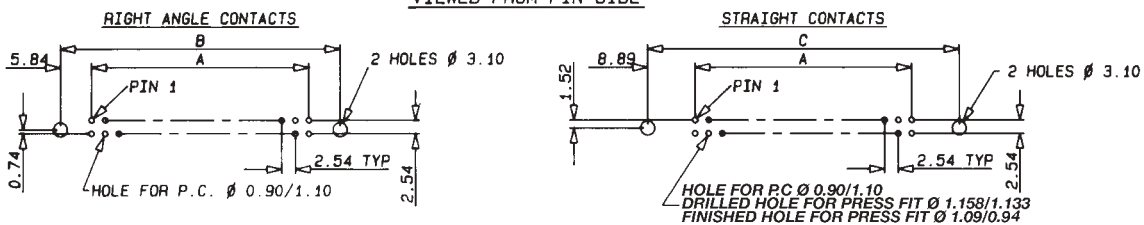

### DIMENSIONS: millimeters (inches)

No. of Ways	A	B	C	D
10	10.16 (.040)	21.84 (.860)	27.94 (1.10)	32.11 (1.26)
14	15.24 (.060)	26.92 (1.06)	33.02 (1.30)	37.19 (1.46)
16	17.78 (.070)	29.46 (1.16)	35.56 (1.40)	39.73 (1.56)
20	22.86 (.090)	34.54 (1.36)	40.64 (1.60)	44.81 (1.76)
26	30.48 (1.20)	42.16 (1.66)	40.64 (1.90)	52.43 (2.06)
34	40.64 (1.60)	52.32 (2.06)	58.42 (2.30)	62.59 (2.46)
40	48.26 (1.90)	59.94 (2.36)	66.04 (2.60)	70.21 (2.76)
50	60.96 (2.40)	72.64 (2.86)	78.74 (3.10)	82.91 (3.26)
60	73.66 (2.90)	85.34 (3.36)	91.44 (3.60)	95.61 (3.76)
64	78.74 (3.10)	90.42 (3.56)	96.52 (3.80)	100.69 (3.96)

# Low Profile IDC Socket Connector



## Series 8290

Available in industry standard sizes of 10-64 positions. They mate to Elco Series 8289, 8293, 8380 and 8383 headers, as well as other industry compatible connectors. An optional strain relief, which can be easily fitted, eliminates stress on the cable. An in-contact polarizing key is available to ensure positive polarization. Contacts are copper alloy for added reliability, and are designed to mate to 0.024" (0.60mm) to 0.025" (0.64mm) square pins. The contact design facilitates maximum wipe on the header pins. (early mate, late break).



## TECHNICAL SPECIFICATION

### Material:

Molding - UL94VO rated glass filled grey polyester

Contact - Phosphor bronze

### Contact Plating:

Contacts are selective gold-plated over nickel, reflow tin lead on IDC section

### Current Rating:

1 ampere at 70°C maximum ambient

### Voltage Rating:

350V DC or AC peak

### Dielectric Withstanding Voltage:

1050V DC or AC peak

### Insulation Resistance:

>1000 megohms

### Contact Resistance:

Initially, 10 milliohms maximum

### Operating Temperature:

-55°C to +105°C

### Wire Gauge:

26 AWG Solid & Stranded

28 AWG Solid & Stranded

## CUSTOMER APPLICATION TOOLING

A standard hand press set and platen is available. See page 27.

## POLARIZING KEYS (strip of 10)

**Order Code:** 60 8290 4410 10 000

## ORDERING CODE

**00**  
|  
Connector Code Prefix

**8290**  
|  
Series Number

**010**  
|  
Number of Circuits

010 = 10 position  
014 = 14 position  
016 = 16 position  
020 = 20 position  
026 = 26 position  
034 = 34 position  
040 = 40 position  
044 = 44 position\*  
050 = 50 position  
060 = 60 position  
064 = 64 position

**000**  
|  
Strain Relief

000 = Without strain relief (feed thru) Standard  
001 = With strain relief (feed thru) Standard  
006 = With latching strain relief (feed thru) see series 8380 page 20

**01**  
|  
Plating

01 = 30μ Gold over Nickel  
04 = 10μ Gold over Nickel

**1**  
|  
Polarization

1 = With central polarizing boss  
2 = Without central polarizing boss

\*44 position connector is only available without strain relief - consult sales office for availability.

# Low Profile IDC Socket Connector



## Series 8290

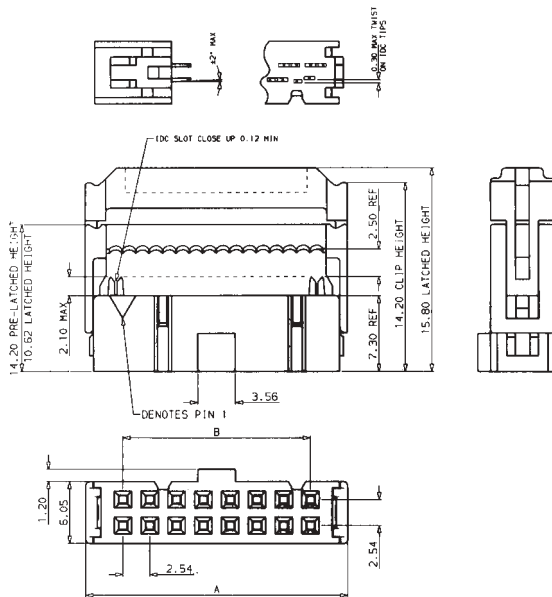

### Dimensions: millimeters (inches)

No. of Contacts	A	B
10	17.22 (0.68)	10.16 (0.40)
14	22.30 (0.88)	15.24 (0.60)
16	24.84 (0.98)	17.78 (0.70)
20	29.92 (1.18)	22.86 (0.90)
26	37.54 (1.48)	30.48 (1.20)
34	47.70 (1.88)	40.64 (1.60)
40	55.32 (2.18)	48.26 (1.90)
44	60.40 (2.38)	53.34 (2.10)
50	68.02 (2.68)	60.69 (2.39)
60	80.72 (3.18)	73.66 (2.90)
64	85.80 (3.38)	78.74 (3.10)

### Standard 001 Strain Relief

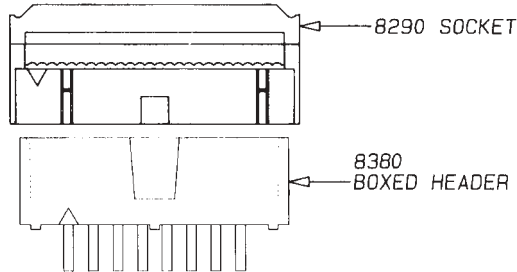

### Latching 006 Strain Relief

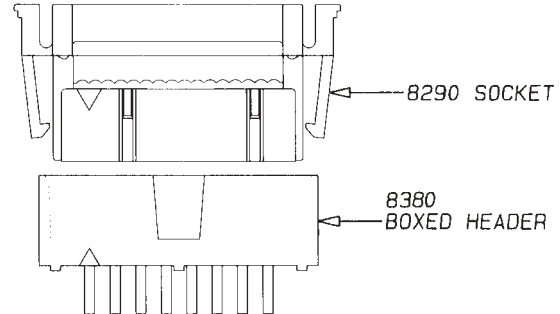

### Standard Strain Relief Order Code

Part Numbers when ordered separately

10 position	60 8290 6610 00 000
14 position	60 8290 6614 00 000
16 position	60 8290 6616 00 000
20 position	60 8290 6620 00 000
26 position	60 8290 6626 00 000
34 position	60 8290 6634 00 000
40 position	60 8290 6640 00 000
50 position	60 8290 6650 00 000
60 position	60 8290 6660 00 000
64 position	60 8290 6664 00 000

### Latching Strain Relief Order Code

Part Numbers when ordered separately

10 position	60 8290 68 10 000 00
14 position	60 8290 68 14 000 00
16 position	60 8290 68 16 000 00
20 position	60 8290 68 20 000 00
26 position	60 8290 68 26 000 00
34 position	60 8290 68 34 000 00
40 position	60 8290 68 40 000 00
50 position	60 8290 68 50 000 00
60 position	60 8290 68 60 000 00
64 position	60 8290 68 64 000 00

# Transition Connector

## Series 8292



Transition connectors are available in industry standard sizes of 10-60 positions. This IDC connector provides a fast, permanent, and economical termination of ribbon cable to PC boards. It can be used as either a daisy chain or end type termination connector. Pin lengths are available to suit 0.063" (1.6mm) or 0.126" (3.2mm) PC boards. Designed to accommodate the industry standard 4 row PC Board hold pattern, the connector also incorporates standoffs which enable efficient flux washing and de-gassing to take place.

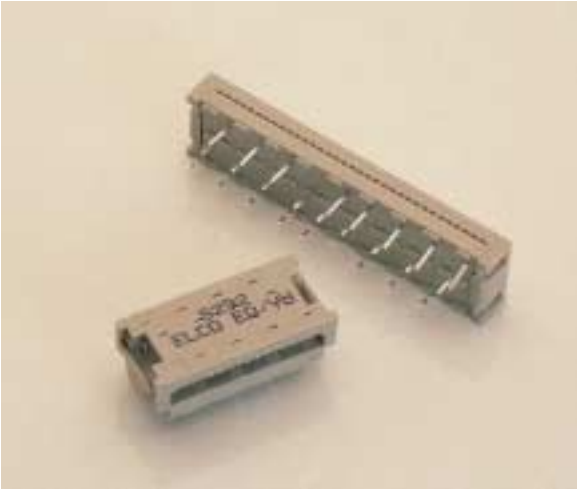

### TECHNICAL SPECIFICATION

**Material:**

Molding - UL94VO rated glass filled grey polyester

Contact - Phosphor bronze

**Contact Plating:**

Tin lead

**Current Rating:**

1 ampere

**Insulation Resistance:**

1000 megohms

**Voltage Rating:**

1000V DC or AC peak

**Operating Temperature:**

-55°C to +105°C

**Wire Gauge:**

26 AWG Solid & Stranded

28 AWG Solid & Stranded

**UL File No:** E90723

**CSA File No:** 1255749

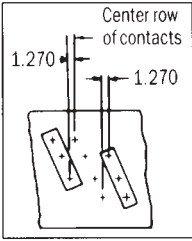

To suit	E
1.60 PCB	2.54
3.20 PCB	3.94

**DIMENSIONS:** millimeters (inches)

No. of Ways	A	B	C	D
10	17.78 (0.70)	19.08 (0.75)	9	11.43 (0.45)
16	25.40 (1.00)	26.70 (1.05)	15	19.05 (0.75)
20	30.48 (1.20)	31.78 (1.25)	19	24.13 (0.95)
26	38.10 (1.50)	39.40 (1.55)	25	31.75 (1.25)
34	48.26 (1.90)	49.56 (1.95)	33	41.91 (1.65)
40	55.88 (2.20)	57.18 (2.25)	39	49.53 (1.95)
50	68.58 (2.70)	69.88 (2.75)	49	62.23 (2.45)
60	81.28 (3.20)	82.58 (3.25)	59	74.94 (2.95)

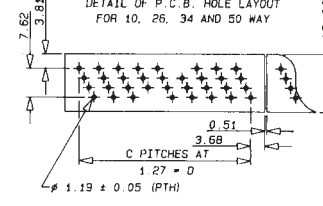
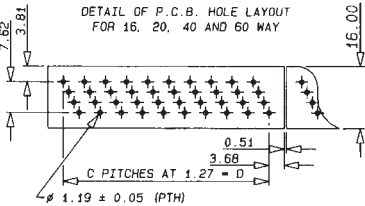
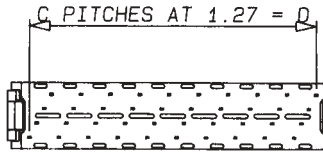
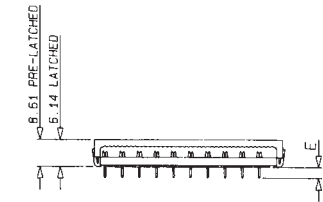
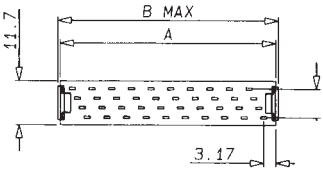

# Transition Connector



## Series 8292

---

### CUSTOMER APPLICATION TOOLING

A standard hand press set and platen is available. See page 27.

### ORDERING CODE

**00**  
|  
**Connector Code  
Prefix**

**8292**  
|  
**Series Number**

**010**  
|  
**Number of  
Contacts**  
010 = 10 position  
016 = 16 position  
020 = 20 position  
026 = 26 position  
034 = 34 position  
040 = 40 position  
050 = 50 position  
060 = 60 position

**001**  
|  
**PCB Thickness**  
001 = Suitable for  
1.6mm PCB  
002 = Suitable for  
3.2mm PCB

**010**  
|  
**Plating**  
010 = Tin alloy

# Male Plug Connector

## Series 8293

**Series 8293 IDC** male plug connectors are available in industry standard sizes of 10 to 64 positions. They mate with Series 8290 IDC sockets as well as other industry compatible connectors. The housing gives full protection to contact pins, and has the optional facility of fitting dual height polarizing keys to prevent incorrect insertion of the mating socket.



### TECHNICAL SPECIFICATION

**Material:**  
Molding - UL94VO rated glass filled grey polyester  
Contact - Phosphor bronze

**Contact Plating:**  
Gold over nickel

**Current Rating:**  
1 ampere at 70°C maximum ambient

**Voltage Rating:**  
350V DC or AC peak

**Insulation Resistance:**  
>1000 megohms

**Dielectric Withstanding Voltage:**  
1050 DC or AC peak

**UL and CSA Approval pending**

**Operating Temperature:**  
-55°C to +105°C

**Contact Resistance:**  
Initially, 10 milliohms max.

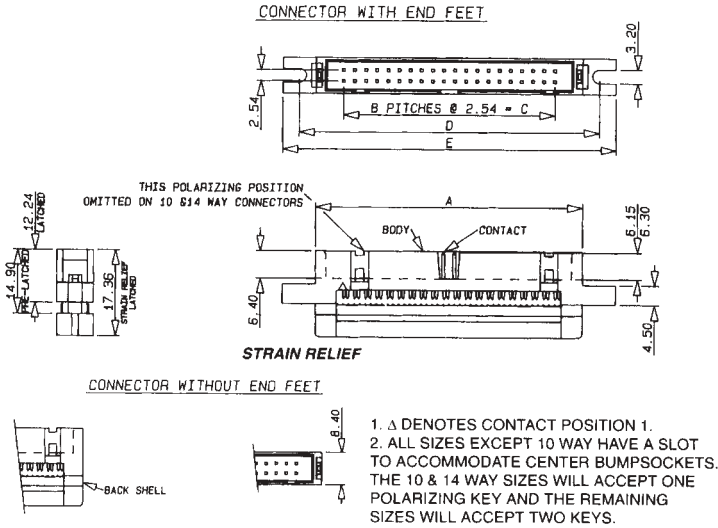

**DIMENSIONS:** millimeters (inches)

No. of Ways	A	B	C	D	E
10	22.89 (0.901)	4	10.16 (0.400)	30.48 (1.200)	38.10 (1.500)
14	27.97 (1.101)	6	15.24 (0.600)	35.56 (1.400)	43.18 (1.700)
16	30.51 (1.201)	7	17.78 (0.700)	38.10 (1.500)	45.72 (1.800)
20	35.59 (1.401)	9	22.86 (0.900)	43.18 (1.700)	50.80 (2.000)
26	43.21 (1.701)	12	30.48 (1.200)	50.80 (2.000)	56.59 (2.228)
34	53.37 (2.101)	16	40.64 (1.600)	60.96 (2.400)	68.58 (2.700)
40	60.99 (2.401)	19	48.26 (1.900)	68.58 (2.700)	76.20 (3.000)
50	73.69 (2.091)	24	60.96 (2.400)	81.28 (3.200)	88.90 (3.500)
60	86.39 (3.401)	29	73.66 (2.900)	93.98 (3.700)	101.60 (4.000)
64	91.47 (3.601)	31	78.74 (3.100)	98.74 (3.900)	106.68 (4.200)



# Male Plug Connector



## Series 8293

### CUSTOMER APPLICATION TOOLING

A standard hand press set and platen is available. See page 27.

### POLARIZING KEYS

**Order Code:** 90 2118 7000 00 000

### ORDERING CODE

<b>10</b>	<b>8293</b>	<b>026</b>	<b>000</b>	<b>01</b>	<b>0</b>
<b>Connector Code Prefix</b>	<b>Series Number</b>	<b>Number of Contacts</b>	<b>Assembly Variation</b>	<b>Plating Variation</b>	<b>Polarization Variation</b>
10 = Standard Connector Assembly with mounting flange 11 = Standard Connector Assembly without mounting flange		010 = 10 position 014 = 14 position 016 = 16 position 020 = 20 position 026 = 26 position 034 = 34 position 040 = 40 position 050 = 50 position 060 = 60 position 064 = 64 position	000 = Connector without strain relief 001 = Connector with strain relief	01 = Standard 30µ" Gold over Nickel 04 = 10µ" Gold over Nickel	0 = No Polarizing 2 = Dual Height Type A

#### Strain Relief Order Code

10 position	60 8293 3310 00 000
14 position	60 8293 3314 00 000
16 position	60 8293 3316 00 000
20 position	60 8293 3320 00 000
26 position	60 8293 3326 00 000
34 position	60 8293 3334 00 000
40 position	60 8293 3340 00 000
50 position	60 8293 3350 00 000
60 position	60 8293 3360 00 000
64 position	60 8293 3364 00 000

# Low Profile Box Header



## Series 8380

Low profile box headers are available in industry standard sizes of 10-64 positions. They mate to Elco Series 8290 IDC sockets, as well as other industry compatible connectors. Both straight and right angle solder dip pins for PC boards are available together with straight press-fit versions. The connector is shrouded on all four sides for polarization and contact protection. Polarizing keys are molded in for correct socket alignment with contact loss.



## TECHNICAL SPECIFICATION

### Material:

Molding - UL94VO rated glass filled grey polyester

Contact - Brass

### Contact Plating:

Selective gold over nickel plating on the mating face, reflow tin lead on IDC section

### Current Rating:

1 ampere at 70°C maximum ambient

### Voltage Rating:

350V DC or AC peak

### Contact Resistance:

Initially 10 milliohms maximum

### Dielectric Withstanding Voltage:

>1050 DC or AC peak

### Insulation Resistance:

>1000 megohms

### Operating Temperature:

-55°C to +105°C

UL File No. E90723

CSA File No. 1255749

## ORDERING CODE

00

### Connector Code Prefix

00 = Standard Connector Assembly

8380

### Series Number

050

### Number of Contacts

010 = 10 position  
014 = 14 position  
016 = 16 position  
020 = 20 position  
026 = 26 position  
034 = 34 position  
040 = 40 position  
050 = 50 position  
060 = 60 position  
064 = 64 position

000

### Contact Variation

000 = Solder Tail Straight Contact for 1.6mm PCB - Contact Length (2.8mm)  
001 = Solder Tail Straight Contact for 2.4mm PCB - Contact Length (3.6mm)  
002 = Solder Tail Right Angle Contact for 1.6mm PCB - Contact Length (2.8mm)  
003 = Solder Tail Right Angle Contact for 2.6mm PCB - Contact Length (3.6mm)  
009 = Press-Fit Contact for 2.4/3.2 PCB - Contact Length (4.5mm)

01

### Plating Variation

01 = 30μ" Gold over Nickel solder  
04 = 10μ" Gold over Nickel

01

### Polarization

0 = No Polarizing Keys Standard  
2 = Type B - Dual Height molded in polarizing key(s)

NB: Additional plating and tail lengths are available. Consult sales office for availability.

# Low Profile Box Header



## Series 8380

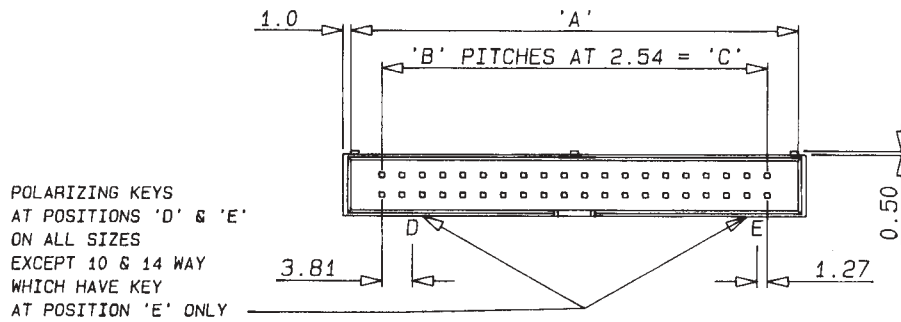

### P.C.B CONTACT VARIATIONS

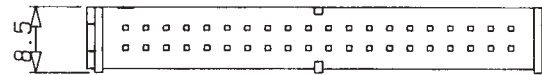
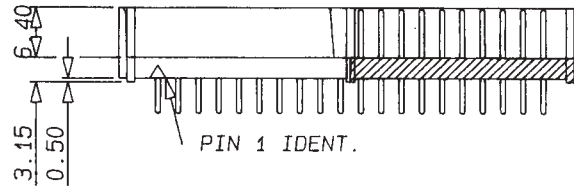
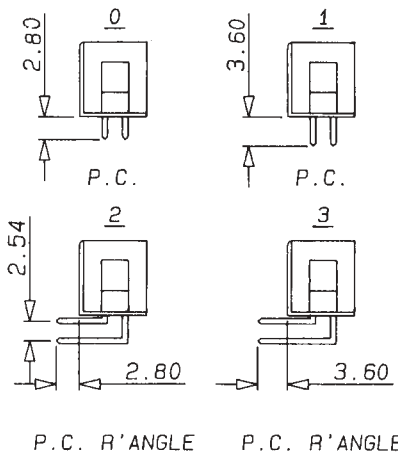

WITHOUT POL-KEY

DUAL HEIGHT  
POL-KEY

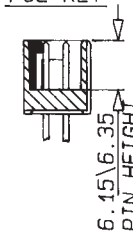

### DIMENSIONS: millimeters (inches)

No. of Contacts	A	B	C
10	17.90 (0.705)	4	10.16 (0.40)
14	22.98 (0.905)	6	15.24 (0.60)
16	25.52 (1.00)	7	17.78 (0.70)
20	30.60 (1.20)	9	22.86 (0.90)
26	38.22 (1.50)	12	30.48 (1.20)
34	48.38 (1.90)	16	40.64 (1.60)
40	56.00 (2.20)	19	48.26 (1.90)
50	68.70 (2.70)	24	60.96 (2.40)
60	81.40 (3.20)	29	73.66 (2.90)
64	86.48 (3.20)	31	78.74 (3.10)

### BOARD HOLE DETAILS

VIEWED FROM PIN SIDE

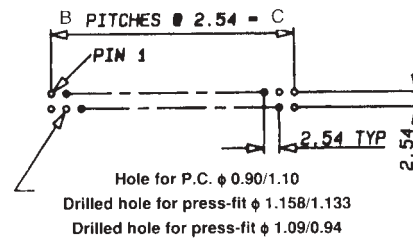

# High Temperature Box Header



## Series 8383

**Series 8383** box headers are designed to be suitable for applications using either infra red or vapor phase equipment. These connectors are designed to mate with Series 8290 IDC sockets as well as other industry compatible connectors.

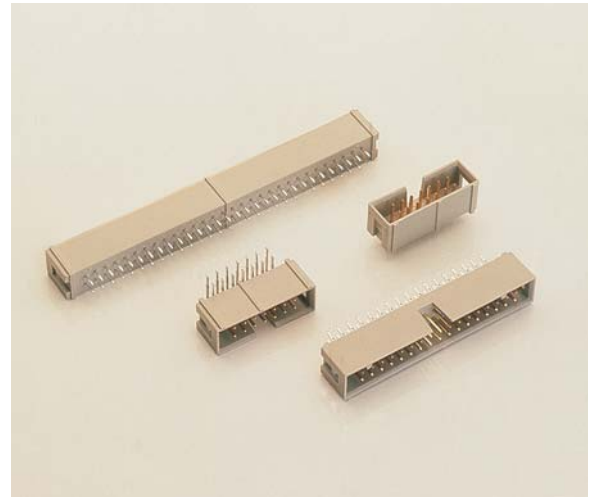

### TECHNICAL SPECIFICATION

**Termination Type:**

Plated Through Hole

**Termination Pitch:**

0.100" (2.54mm)

**Material:**

Housing - UL94VO rated high thermal resistant nylon

Contact - Brass

**Contact Plating:**

Gold over nickel

**Contact Resistance:**

Initially 10 milliohms maximum

**Current Rating:**

1 ampere at 70°C maximum ambient

**Insulation Resistance:**

>1000 megohms

**Voltage Rating:**

350V DC or AC peak

**Heat Deflection Temperature:**

285°C

### ORDERING CODE

**00**

**Connector Code Prefix**

00 = Standard Connector Assembly

**8383**

**Series Number**

**050**

**Number of Contacts**

010 = 10 position  
014 = 14 position  
016 = 16 position  
020 = 20 position  
026 = 26 position  
034 = 34 position  
040 = 40 position  
050 = 50 position  
060 = 60 position  
064 = 64 position

**000**

**Contact Variation**

000 = Solder PC Straight (1.60mm PCB) Length 2.90mm  
001 = Solder PC Right Angle (2.40mm PCB) Length 3.70mm  
002 = Solder PC Right Angle (1.6mm PCB) Length 2.90mm  
003 = Solder PC Straight (2.40mm PCB) Length 3.70mm  
009 = Press Fit contact for 2.4/3.2mm PCB or contact length 4.5mm

**0**

**Clip Variation**

0 = No Clip

**1**

**Plating Variation**

1 = 30µ" Gold over Nickel  
4 = 10µ" Gold over Nickel

**0**

**Polarization**

0 = No Polarizing



# Dual In-Line Transition Connector



## Series 8399

**Series 8399** dual in-line transition connector is available in industry standard sizes of 10-64 positions. It will accommodate Series 2026 0.050" (1.27mm) ribbon cable, and is available with or without strain relief and has an optional cable stop facility. It forms a simple and cost effective method of terminating IDC ribbon cable to a PCB.



### TECHNICAL SPECIFICATION

**Material:**

Molding - UL94VO rated glass filled grey polyester

Contact - Phosphor bronze

**Contact Plating:**

Tin lead

**Current Rating:**

1 ampere

**Voltage Rating:**

350V DC or AC peak

**Insulation Resistance:**

>1000 megohms

**Dielectric Withstanding Voltage:**

1050 DC or AC peak

**Operating Temperature:**

-55°C to +105°C

**Wire Gauge:**

26 AWG Solid & Stranded

28 AWG Solid & Stranded

**UL File No.** E90723

**CSA File No.** 1255749

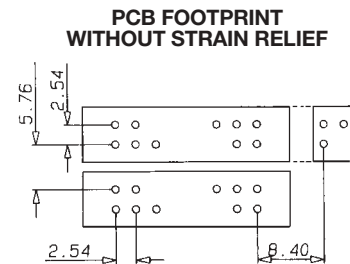
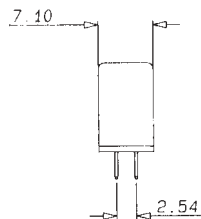
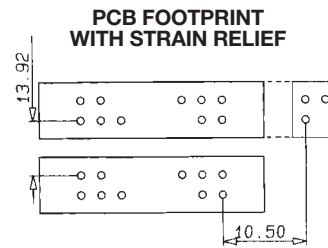

**WITH STRAIN RELIEF**

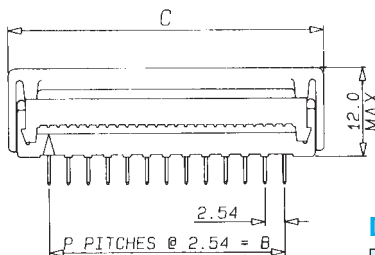

**WITHOUT STRAIN RELIEF**

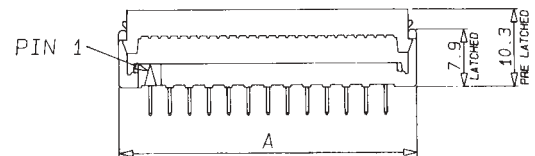

**DIMENSIONS:** millimeters (inches)

No. of Positions	A	B	P	C
010	18.45 (0.726)	10.16 (.400)	4	20.27 (0.798)
014	23.53 (0.926)	15.24 (.600)	6	25.65 (1.01)
016	26.07 (1.03)	17.78 (.700)	7	28.19 (1.11)
020	31.15 (1.23)	22.86 (.900)	9	33.27 (1.31)
026	38.77 (1.53)	30.48 (1.20)	12	40.89 (1.61)
034	48.93 (1.93)	40.64 (1.60)	16	51.05 (2.01)
040	56.55 (2.23)	48.26 (1.90)	19	58.67 (2.31)
050	69.25 (2.73)	60.96 (2.40)	24	71.37 (2.81)
060	81.95 (3.23)	73.66 (2.90)	39	84.07 (3.31)
064	87.03 (3.42)	78.74 (3.10)	31	89.15 (3.51)

# Dual In-Line Transition Connector



## Series 8399

### CUSTOMER APPLICATION TOOLING

A standard hand press set and platen is available. See page 27.

### ORDERING CODE

<b>00</b>	<b>8399</b>	<b>016</b>	<b>00</b>	<b>0</b>	<b>2</b>	<b>02</b>
<b>Connector Code Prefix</b>	<b>Series Number</b>	<b>Number of Contacts</b>	<b>Strain Relief</b>	<b>Cable Stop</b>	<b>Contact</b>	<b>Plating</b>
00 = Standard		010 = 10 position 014 = 14 position 016 = 16 position 020 = 20 position 026 = 26 position 034 = 34 position 040 = 40 position 050 = 50 position 060 = 60 position 064 = 64 position	00 = Without strain relief 01 = With strain relief	0 = Without cable stop Standard 1 = With cable stop Special	2 = 3.6mm tail phosphor bronze 3 = 2.8mm tail phosphor bronze	02 = Tin Lead

# IDC DIN Connector

## Series 8459



**Series 8459** IDC DIN connectors are based on DIN 41612. This series is loaded with 64 contacts in 2 rows of 32 in rows "A" and "C". Also available is a 1/2 "C" version, with 2 rows of 16 contacts, also loaded in rows "A" and "C". A strain relief is available as an option. Use of the Series 2521 accessory, which is optional, provides a connector latch and eject system from inverted format shells. This connector series will mate with any industry standard DIN connectors that are loaded only in rows "A" and "C".



### TECHNICAL SPECIFICATION

**Material:**

Molding - UL94VO rated grey polyester  
Contact - Phosphor bronze

**Contact Plating:**

Gold over nickel

**Current Rating per contact**

at ambient +20°C 3 amp  
+70°C 1.5 amp  
+100°C 1 amp

**Working Voltage:**

350V DC or AC peak

**Contact Resistance:**

15 milliohms max.

**Operating Temperature:**

-55°C to +125°C

**Insertion/Withdrawal Force (Mating):**

1N max/0.2N min per contact

**Wire Gauge:**

26 AWG Solid & Stranded  
28 AWG Solid & Stranded

### CUSTOMER APPLICATION TOOLING

A standard hand press set and platen is available. See page 27.

### ORDERING CODE

**20**  
Connector Code Prefix

**8459**  
Series Number

**096**  
Insulator Size  
048 or 096 (See note)

**001**  
Variation  
001 = With strain relief  
002 = Without strain relief

**026**  
Plating Gold over Nickel  
002 = DIN Class III  
026 = Class II  
050 = Class I

Note: 96 position insulator fitted with 2 rows of 32 contacts, rows A and C.  
48 position insulator fitted with 2 rows of 16 contacts, rows A and C.

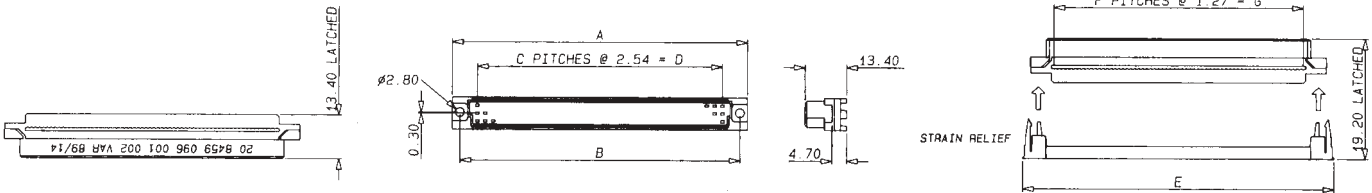

**DIMENSIONS:** millimeters (inches)

Insulator Size	A	B	C	D	E	F	G
048 position (3 x 16)	54.90 (2.16)	50.00 (1.97)	15	38.10 (1.50)	60.00 (2.36)	31	39.37 (1.55)
096 position (3 x 32)	94.90 (3.74)	90.00 (3.54)	31	78.74 (3.10)	100.00 (3.94)	63	80.01 (3.15)



## TOGGLE PRESS

The Elco toggle press is capable of terminating 125 connectors per hour. The press features long horned guides for the ram which provides precise alignment. The press is fitted with a return mechanism allowing the return of the ram to its starting position after its entire extension. An offset hand lever permits good operator visibility of the work. A micro-meter attachment to the ram is factory set. The range of platens for the toggle press is identical to those for the pneumatic press, thereby allowing the use of existing tooling when upgrading to a pneumatic press.



### ORDERING CODE

<b>Toggle Press Ordering Code</b>	06 8290 7225 00 000
<b>Platen Ordering Code</b>	
Series 8290 socket	06 8290 7207 01 000
DIL transition connectors	06 8399 7009 00 000
Staggered transition connectors	06 8292 7010 00 000
Card edge connectors	06 6338 7116 00 000
DIL 14/16 connectors	06 8291 7009 00 000

### TECHNICAL DATA

Force output max.	12 kN (2600 lbs)
Stroke	45mm (1.8 in)
Working height adjustable	120-360mm (5-14 in)
Overhang	86mm (3.4 in)
Ram bore dia	10 H 7 x 28mm (1/2 x 1 in)
Ram dia	32mm (1 1/4 in)
Table bore dia	20 H 7mm (0.787 in)
Table dimension	185 x 115mm (7 x 4.5 in)
Breath of T-slot	10 H 9mm (0.394 in)
Weight	30kg (66 lbs)

*Non-metric dimensions are for U.S. versions only.*

## PNEUMATIC PRESS

The Elco pneumatic press is a compact, high precision press providing a fast and accurate method of terminating IDC connectors. The press is capable of terminating 250 connectors per hour and a precision slide table allows all parts to be loaded outside the termination area. The press features service-free bearings and guides. Low maintenance and a favorable noise level of less than 75 dBA. The ram incorporates a micrometer adjustment which is factory set.

A range of platens is available to suit each series of IDC connectors.

Under certain terms, arrangements exist for this press to be leased or loaned by customers. Please consult our sales representative for further information and outright purchase price.



### ORDERING CODE

<b>Pneumatic Press Ordering Code</b>	06 8290 7207 00 000
<b>Platen Ordering Code</b>	
Series 8290 socket	06 8290 7207 01 000
DIL transition connectors	06 8399 7009 00 000
Staggered transition connectors	06 8292 7010 00 000
Card edge connectors	06 6338 7116 00 000
DIL 14/16 connectors	06 8291 7009 00 000

### TECHNICAL DATA

Force output max.	15 kN (3300 lbs)
Stroke	Factory Set
Air consumption (per stroke)	0.12scf/in (3.0 litre/cm)
Working height adjustable	3.5-8 in (90-210mm)
Overhang	3.4 in (86mm)
Ram dia	1.57 in (40mm)
Ram bore dia with fixation screw M10	5/8 x 2 in (20 H7 x 50mm)
Breadth of T-slot	0.394 in (10 H 9mm)
Table bore dia	0.787 in (20 H 7mm)
Table dimension	6 x 4 in (150 x 110mm)
Space requirement	6 x 10 in (155 x 260mm)
Air connection thread	R 1/4 in
Weight	45kg (100 lbs)

*Non-metric dimensions are for U.S. versions only.*

### CONNECTORS

Automotive Connectors

DIN 41612

Board-to-Board Connectors - SMT and Thru-Hole

Post and Box

Torson™

Customized Backpanel, Racking and Harnessing Services

Card Edge

Memory Card Headers and Sockets

Wire-to-Board - Crimp and IDC

MOBO™

I/O Connectors

FFC/FPC

Custom Designed Connectors

### PASSIVES

MLC Capacitors

Tantalum Capacitors

Microwave Capacitors

Thin-Film Capacitors

Glass Capacitors

Chip Resistors

Networks

EMI Filters

Bulk Filters

Saw Filters

Dielectric Filters

Resonators

Oscillators

Thin-Film Inductors

Thin-Film Fuses

Voltage Suppressors

Acoustical Piezos

### TPC PRODUCTS

Film Capacitors

Non Linear Resistors

Metal Oxide Varistors

Ceramic Disc Capacitors

Soft Ferrites

Power Capacitors

X & Y Suppressor Capacitors

# Elco – World Class Connections

## USA

**AVX Myrtle Beach, SC  
Corporate Offices**

Tel: 843-448-9411  
FAX: 843-626-5292

**AVX Northwest, WA**

Tel: 360-699-8746  
FAX: 360-699-8751

**AVX North Central, IN**

Tel: 317-848-7153  
FAX: 317-844-9314

**AVX Mid/Pacific, MN**

Tel: 952-974-9155  
FAX: 952-974-9179

**AVX Southwest, AZ**

Tel: 480-539-1496  
FAX: 480-539-1501

**AVX South Central, TX**

Tel: 972-669-1223  
FAX: 972-669-2090

**AVX Southeast, NC**

Tel: 919-878-6223  
FAX: 919-878-6462

**AVX Canada**

Tel: 905-564-8959  
FAX: 905-564-9728

## EUROPE

**AVX Limited, England  
European Headquarters**

Tel: ++44 (0) 1252 770000  
FAX: ++44 (0) 1252 770001

**AVX S.A., France**

Tel: ++33 (1) 69.18.46.00  
FAX: ++33 (1) 69.28.73.87

**AVX GmbH, Germany - AVX**

Tel: ++49 (0) 8131 9004-0  
FAX: ++49 (0) 8131 9004-44

**AVX GmbH, Germany - Elco**

Tel: ++49 (0) 2741 2990  
FAX: ++49 (0) 2741 299133

**AVX srl, Italy**

Tel: ++390 (0)2 614571  
FAX: ++390 (0)2 614 2576

**AVX Czech Republic, s.r.o.**

Tel: ++420 (0)467 558340  
FAX: ++420 (0)467 558345

## ASIA-PACIFIC

**AVX/Kyocera, Singapore  
Asia-Pacific Headquarters**

Tel: (65) 258-2833  
FAX: (65) 350-4880

**AVX/Kyocera, Hong Kong**

Tel: (852) 2-363-3303  
FAX: (852) 2-765-8185

**AVX/Kyocera, Korea**

Tel: (82) 2-785-6504  
FAX: (82) 2-784-5411

**AVX/Kyocera, Taiwan**

Tel: (886) 2-2696-4636  
FAX: (886) 2-2696-4237

**AVX/Kyocera, China**

Tel: (86) 21-6249-0314-16  
FAX: (86) 21-6249-0313

**AVX/Kyocera, Malaysia**

Tel: (60) 4-228-1190  
FAX: (60) 4-228-1196

**Elco, Japan**

Tel: 045-943-2906/7  
FAX: 045-943-2910

**Kyocera, Japan - AVX**

Tel: (81) 75-604-3426  
FAX: (81) 75-604-3425

**Kyocera, Japan - KDP**

Tel: (81) 75-604-3424  
FAX: (81) 75-604-3425

Contact:



<http://www.avxcorp.com>

S-IDC5M602-C