

SILICON DIODES

SILICON VARISTORS

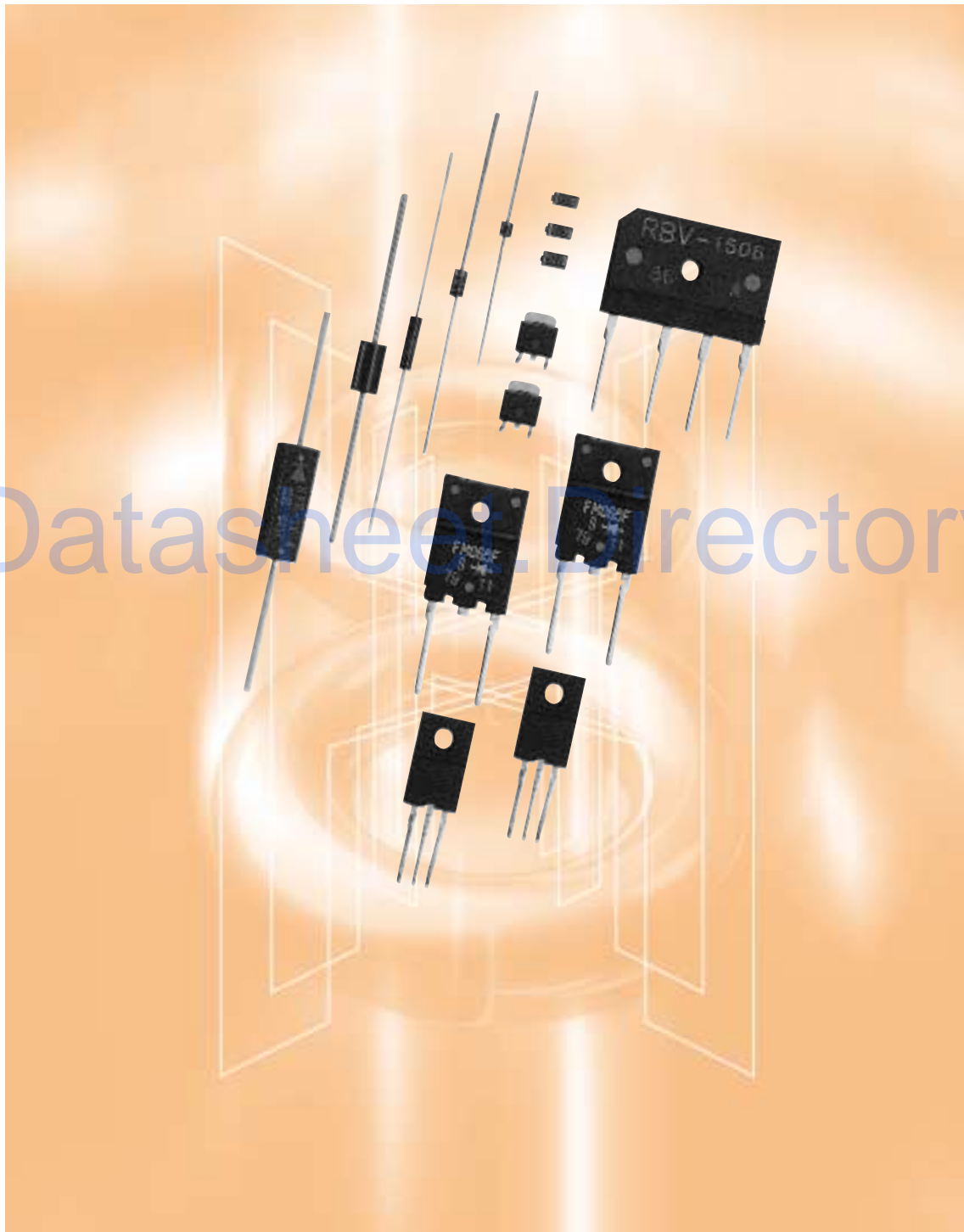

 **CAUTION / WARNING**

- The information in this publication has been carefully checked and is believed to be accurate; however, no responsibility is assumed for inaccuracies.
- Sanken reserves the right to make changes without further notice to any products herein in the interest of improvements in the performance, reliability, or manufacturability of its products. Before placing an order, Sanken advises its customers to obtain the latest version of the relevant information to verify that the information being relied upon is current.
- Application and operation examples described in this catalog are quoted for the sole purpose of reference for the use of the products herein and Sanken can assume no responsibility for any infringement of industrial property rights, intellectual property rights or any other rights of Sanken or any third party which may result from its use.
- When using the products herein, the applicability and suitability of such products for the intended purpose or object shall be reviewed at the users responsibility.
- Although Sanken undertakes to enhance the quality and reliability of its products, the occurrence of failure and defect of semiconductor products at a certain rate is inevitable. Users of Sanken products are requested to take, at their own risk, preventative measures including safety design of the equipment or systems against any possible injury, death, fires or damages to the society due to device failure or malfunction.
- Sanken products listed in this catalog are designed and intended for the use as components in general purpose electronic equipment or apparatus (home appliances, office equipment, telecommunication equipment, measuring equipment, etc.). Before placing an order, the user's written consent to the specifications is requested.
- When considering the use of Sanken products in the applications where higher reliability is required (transportation equipment and its control systems, traffic signal control systems or equipment, fire/crime alarm systems, various safety devices, etc.), please contact your nearest Sanken sales representative to discuss and obtain written confirmation of your specifications.
- The use of Sanken products without the written consent of Sanken in the applications where extremely high reliability is required (aerospace equipment, nuclear power control systems, life support systems, etc.) is strictly prohibited.
- Anti radioactive ray design is not considered for the products listed herein.
- This publication shall not be reproduced in whole or in part without prior written approval from Sanken.

Contents

Selection Guide	2
Rectifier Diodes	2
Fast-Recovery Rectifier Diodes	3
Ultra-Fast-Recovery Rectifier Diodes	4
Schottky Barrier Diodes	5
Damper Diodes / High-Voltage Rectifier Diodes	6
Avalanche Diodes / Power Zener Diodes / Silicon Varistors	7
Symbols and Terms / t_{rr} Measurement Circuit	8
Taping Specifications	8
Marking Guide	11
Rectifier Diodes	12
Fast-Recovery Rectifier Diodes	18
Ultra-Fast-Recovery Rectifier Diodes	25
Schottky Barrier Diodes	35
Damper Diodes	40
High-Voltage Rectifier Diodes	42
Avalanche Diodes	44
Power Zener Diodes	45
Silicon Varistors	46
Characteristic Curves	48
Application Notes	107
Product Index by Part Number	108

Selection Guide

Rectifier Diodes

●1 in one-package

V _{RM} (V)	I _F (A)	I _{FSM} (A)	Part Number	Package	Page
100	1.0	45	EM 1Y	Axial (E1)	12
	3.0	200	RM 4Y	Axial (R4)	
200	0.9	30	SFPM-52	Surface Mount (SFP)	13
		45	SFPM-62		
		35	AM01Z	Axial (A0)	
	1.0	45	EM01Z	Axial (E0)	
		45	EM 1Z	Axial (E1)	
		50	RM 1Z	Axial (R1)	
		1.2	100	RM 2Z	
	80		RO 2Z		
	1.5	120	RM 10Z	Axial (R1)	
	3.0	200	RM 4Z	Axial (R4)	
400	0.9	30	SFPM-54	Surface Mount (SFP)	14
		45	SFPM-64		
		50	SFPM-74		
	1.0	35	AM01	Axial (A0)	
		45	EM01	Axial (E0)	
		45	EM 1	Axial (E1)	
		50	RM 1	Axial (R1)	
		1.2	80	EM 2	
	150		RM 10	Axial (R1)	
	100		RM 2	Axial (R2)	
	80		RO 2		
	2.5	150	RM 3	Axial (R3)	
	3.0	200	RM 4	Axial (R4)	
	600	1.0	35	AM01A	
45			EM01A	Axial (E0)	
45			EM 1A	Axial (E1)	
50			RM 1A	Axial (R1)	
1.2		80	EM 2A	Axial (E1)	
		150	RM 10A	Axial (R1)	
		100	RM 11A		
		100	RM 2A	Axial (R2)	
		80	RO 2A		
2.5		150	RM 3A	Axial (R3)	
3.0		200	RM 4A	Axial (R4)	
3.2		350	RM 4AM		
800		0.8	40	RM 1B	Axial (R1)
	1.0	35	EM 1B	Axial (E1)	
		80	EM 2B		
	1.2	150	RM 10B	Axial (R1)	
		100	RM 11B		
		100	RM 2B	Axial (R2)	
		80	RO 2B		
2.5	100	RM 3B	Axial (R3)		
3.0	150	RM 4B	Axial (R4)		
1000	0.8	40	RM 1C	Axial (R1)	17
	1.0	35	EM 1C	Axial (E1)	
		100	RM 11C		
	1.2	100	RM 2C	Axial (R2)	
		80	RO 2C		
	2.0	150	RM 3C	Axial (R3)	
3.0	100	RM 4C	Axial (R4)		

●2 in one-package

V _{RM} (V)	I _F (A)	I _{FSM} (A)	Part Number	Package	Page
100	20	120	FMM-31S, R	FM80	12
200	10	100	FMM-22S, R	TO-220F	13
	20	120	FMM-32S, R	FM80	
400	10	100	FMM-24S, R	TO-220F	14
	20	120	FMM-34S, R	FM80	
600	10	100	FMM-26S, R	TO-220F	15
	20	120	FMM-36S, R	FM80	

●Bridge

V _{RM} (V)	I _F (A)	I _{FSM} (A)	Part Number	Package	Page	
100	4.0	80	RBV-401	RBV-40	12	
	6.0	100	RBV-601	RBV-60		
200	4.0	80	RBV-402	RBV-40	13	
	6.0	120	RBV-602	RBV-60		
	10	80	RBV-4102	RBV-40		
400	4.0	80	RBV-404	RBV-60	14	
	6.0	150	RBV-604	RBV-40		
600	4.0	80	RBV-406	RBV-40	15	
	4.0	120	RBV-406H			
	4.0	120	RBV-406M			
	6.0	150	RBV-606	RBV-60		
	6.0	140	RBV-606H			
	8.0	120	RBV-4086H	RBV-40		
	10	120	RBV-4106M			
	13	80	RBV-1306			
	800	15	200	RBV-1506		RBV-60
		15	150	RBV-1506S		
15		150	RBV-1506J			
25		350	RBV-2506			
4.0		100	RBV-408	RBV-40		
1000	6.0	170	RBV-608	RBV-60	16	
	4.0	100	RBV-40C	RBV-40	17	
15	200	RBV-150C *	RBV-60			

* : Under development

Selection Guide

Fast-Recovery Rectifier Diodes

trr ①: I_R = I_F 90% Recovery Point
trr ②: I_R = 2 • I_F 75% Recovery Point

●1 in one-package

V _{RM} (V)	I _F (A)	I _{FSM} (A)	t _{rr} ① (μs)	t _{rr} ② (μs)	Part Number	Package	Page		
100	1.2	25	0.2	0.08	EU 2YX	Axial (E1)	18		
	1.5	30	0.2	0.08	RU 2YX	Axial (R1)			
	2.0	50	0.2	0.08	RU 3YX	Axial (R2)			
	3.5	100	0.4	0.18	RU 30Y	Axial (R3)			
		70	0.4	0.18	RU 4Y	Axial (R4)			
	4.0	100	0.2	0.08	RU 4YX				
	10.0	100	0.2	0.08	FMU-G2YXS	TO-220F-2Pin			
200	0.25	15	0.4	0.18	EU01Z	Axial (E0)	19		
		15	0.4	0.18	EU 1Z	Axial (E1)			
	0.5	15	0.4	0.18	AU01Z	Axial (A0)			
		20	1.5	0.6	AS01Z				
	0.6	30	4.0	1.3	EH 1Z	Axial (E1)			
		15	0.4	0.18	RF 1Z	Axial (R1)			
		35	4.0	1.3	RH 1Z				
	0.7	30	1.5	0.6	ES 1Z	Axial (E1)			
		30	1.5	0.6	ES01Z	Axial (E0)			
	0.8	25	0.4	0.18	AU02Z	Axial (A0)			
		15	0.4	0.18	EU02Z	Axial (E0)			
	1.0	15	0.4	0.18	EU 2Z	Axial (E1)			
		20	0.4	0.18	RU 2Z	Axial (R1)			
	3.5	80	0.4	0.18	RU 30Z	Axial (R3)			
		70	0.4	0.18	RU 4Z	Axial (R4)			
	400	0.25	15	0.4	0.18	EU01		Axial (E0)	20
			15	0.4	0.18	EU 1		Axial (E1)	
		0.5	15	0.4	0.18	AU 1		Axial (A0)	
			20	1.5	0.6	AS01			
0.6		30	4.0	1.3	EH 1	Axial (E1)			
		15	0.4	0.18	RF 1	Axial (R1)			
		35	4.0	1.3	RH 1				
0.7		30	1.5	0.6	ES01	Axial (E0)			
		30	1.5	0.6	ES 1	Axial (E1)			
0.8		25	0.4	0.18	AU02	Axial (A0)			
		15	0.4	0.18	EU02	Axial (E0)			
1.0		15	0.4	0.18	EU 2	Axial (E1)			
		20	0.4	0.18	RU 2M	Axial (R1)			
1.5		20	0.4	0.18	RU 3	Axial (R2)			
		50	0.4	0.18	RU 3M				
2.0		200	0.4	0.18	RU 30	Axial (R3)			
		150	0.4	0.18	RU 31				
3.0		50	0.4	0.18	RU 4	Axial (R4)			
		70	0.4	0.18	RU 4M				
600		0.25	15	0.4	0.18	EU01A	Axial (E0)	21	
	15		0.4	0.18	EU 1A	Axial (E1)			
	0.5	15	0.4	0.18	RU 1A	Axial (R1)			
		15	0.4	0.18	AU01A		Axial (A0)		
	0.6	20	1.5	0.6	AS01A				
		30	4.0	1.3	EH 1A	Axial (E1)			
		15	0.4	0.18	RF 1A	Axial (R1)			
	35	4.0	1.3	RH 1A					
	0.7	30	1.5	0.6	ES01A	Axial (E0)			
		30	1.5	0.6	ES 1A	Axial (E1)			
	0.8	30	1.5	0.6	RS 1A	Axial (R1)			
		25	0.4	0.18	AU02A	Axial (A0)			
	1.0	15	0.4	0.18	EU02A	Axial (E0)			
		15	0.4	0.18	EU 2A	Axial (E1)			
	1.1	20	0.4	0.18	RU 2AM	Axial (R1)			
		20	0.4	0.18	RU 20A				
	1.5	20	0.4	0.18	RU 3A	Axial (R2)			
		50	0.4	0.18	RU 3AM				
	2.0	200	0.4	0.18	RU 30A	Axial (R3)			
		150	0.4	0.18	RU 31A				
3.0	50	0.4	0.18	RU 4A	Axial (R4)				
	70	0.4	0.18	RU 4AM					
5.0	30	0.4	0.18	FMUP-1056	TO-220F-2Pin				
10.0	40	0.4	0.18	FMUP-1106					

V _{RM} (V)	I _F (A)	I _{FSM} (A)	t _{rr} ① (μs)	t _{rr} ② (μs)	Part Number	Package	Page	
800	0.25	15	0.4	0.18	RU 1B	Axia (R1)	22	
		15	0.4	0.18	RF 1B			
	0.6	35	4.0	1.3	RH 1B			
		0.7	30	1.5	0.6			RS 1B
	1.0	20	0.4	0.18	RU 2B			Axial (R2)
	1.1	20	0.4	0.18	RU 3B			
	3.0	50	0.4	0.18	RU 4B			Axial (R4)
1000	0.2	15	0.4	0.18	RU 1C	Axial (R1)	23	
		0.6	35	4.0	1.3			RH 1C
	0.8	20	0.4	0.18	RU 2C			Axial (R2)
	1.5	20	0.4	0.18	RU 3C			Axial (R2)
	2.5	50	0.4	0.18	RU 4C			Axial (R4)
1500	0.5	20	1.5	0.6	ES01F	Axial (E0)	24	
		20	1.5	0.6	ES 1F	Axial (E1)		
2000	0.2	20	4.0	1.3	RC 2	Axial (R1)		

●2 in one-package

V _{RM} (V)	I _F (A)	I _{FSM} (A)	t _{rr} ① (μs)	t _{rr} ② (μs)	Part Number	Package	Page
100	10.0	40	0.4	0.18	FMU-21S, R	TO-220F	18
200	5.0	30	0.4	0.18	FMU-12S, R	TO-220F	19
	10.0	40	0.4	0.18	FMU-22S, R		
400	20.0	80	0.4	0.18	FMU-32S, R	FM80	20
	5.0	30	0.4	0.18	FMU-14S, R	TO-220F	
	10.0	40	0.4	0.18	FMU-24S, R		
600	5.0	30	0.4	0.18	FMU-16S, R	TO-220F	21
		30	0.4	0.18	FMUP-2056*		
	10.0	40	0.4	0.18	FMU-26S, R		
	20.0	80	0.4	0.18	FMU-36S, R		

* : Under development

Selection Guide

Ultra-Fast-Recovery Rectifier Diodes

trr①: I_R = I_F 90% Recovery Point
trr②: I_R = 2 • I_F 75% Recovery Point

●1 in one-package

V _{RM} (V)	I _F (A)	I _{FSM} (A)	trr① (ns)	trr② (ns)	Part Number	Package	Page		
70	1.0	25	100	50	AG01Y	Axial (A0)	25		
	1.1	30	100	50	EG01Y	Axial (E0)			
		30	100	50	EG 1Y	Axial (E1)			
		50	100	50	RG 10Y	Axial (R1)			
	1.5	50	100	50	RG 2Y	Axial (R2)			
		3.5	100	100	50	RG 4Y		Axial (R4)	
200	0.7	15	100	50	AG01Z	Axial (A0)	26		
	0.8	15	100	50	EG01Z	Axial (E0)			
		15	100	50	EG 1Z	Axial (E1)			
	0.9	25	50	35	SFPL-52	Surface Mount (SFP)			
		25	50	35	SFPL-62				
	1.0	25	50	35	AL01Z	Axial (A0)			
		25	100	50	EN 01Z	Axial (E0)			
	1.2	50	100	50	RG 10Z	Axial (R1)			
		50	100	50	RG 2Z	Axial (R2)			
	1.5	30	30	25	SFPX-62	Surface Mount (SFP)			
		25	40	30	EL02Z	Axial (E0)			
		20	50	35	EL 1Z	Axial (E1)			
		60	100	50	RN 1Z	Axial (R1)			
	30	30	25	RX 10Z *					
	2.0	30	50	35	RL 10Z	Axial (R2)			
		30	50	35	RL 2Z				
		70	100	50	RN 2Z				
	3.0	80	30	25	RX 3Z	Axial (R3)			
80		100	50	RN 3Z					
80		100	50	RG 4Z					
3.5	50	30	25	SPX-G32S	Surface Mount (D Pack)				
	80	50	35	RL 3Z	Axial (R3)				
	80	50	35	RL 4Z	Axial (R4)				
	120	100	50	RN 4Z					
5.0	65	40	30	FML-G12S	TO-220F-2Pin				
	100	100	50	FMN-G12S					
	65	150	70	FMP-G12S					
	65	30	25	FMX-G12S					
	150	30	25	FMX-G22S					
10.0	150	40	30	FML-G22S					
	2.0	30	30	SFPX-63	Surface Mount (SFP)	28			
5.0	70	50	35	FML-G13S	TO-220F-2Pin				
400	0.7	15	100	50	AG01	Axial (A0)	29		
	0.8	15	100	50	EG01	Axial (E0)			
		15	100	50	EG 1	Axial (E1)			
	1.0	25	50	30	SFPX-64	Surface Mount (SFP)			
		20	50	35	AL01 *	Axial (A0)			
	1.2	50	100	50	RG 10	Axial (R1)			
		50	100	50	RG 2	Axial (R2)			
	1.5	25	50	35	EL 1	Axial (E1)			
		40	50	35	RL 2	Axial (R2)			
	2.0	70	50	35	RL 31 *	Axial (R3)			
		80	100	50	RG 4	Axial (R4)			
	3.5	80	50	35	RL 3	Axial (R3)			
		70	50	35	FML-G14S	TO-220F-2Pin			
	70	100	50	FMN-G14S					
	70	30	25	FMX-G14S *					
	600	0.5	15	100	50	AG01A		Axial (A0)	30
			10	100	50	EG01A		Axial (E0)	
		0.6	10	100	50	EG 1A		Axial (E1)	
50			100	50	RG 10A	Axial (R1)			
1.0		50	100	50	RG 2A	Axial (R2)			
		30	50	35	RD 2A				
2.0		60	50	35	RL 3A	Axial (R3)			
		50	100	50	RG 4A	Axial (R4)			
3.0		80	50	35	RL 4A	Axial (R4)			
4.0		50	100	50	FMG-G26S	TO-220F-2Pin			

* : Under development

V _{RM} (V)	I _F (A)	I _{FSM} (A)	trr① (ns)	trr② (ns)	Part Number	Package	Page
600	5.0	50	50	35	FML-G16S	TO-220F-2Pin	30
		50	100	50	FMN-G16S *		
		50	30	25	FMX-G16S		
	8.0	80	100	50	FMG-G36S	FM80-2Pin	
		100	50	30	FMD-G26S	TO-220F-2Pin	
	10.0	100	35	25	FMX-G26S		
30.0		180	150	70	MP3-306	Surface Mount (TO-220S)	
800	3.0	50	70	35	FMC-G28S	TO-220F-2Pin	32
	5.0	60	70	35	FMC-G28SL		
1000	0.2	5	200	80	AP01C	Axial (A0)	33
		5	200	80	EP01C	Axial (E0)	
	0.4	10	100	50	RU 1P	Axial (R1)	
	0.5	10	100	50	EG01C	Axial (E0)	
	0.7	10	100	50	RG 1C	Axial (R1)	
	2.0	60	100	50	RG 4C	Axial (R4)	
	3.0	30	100	50	FMG-G2CS	TO-220F-2Pin	
5.0	60	150	70	FMG-G3CS	FM80-2Pin		
2000	0.1	5	200	80	RP 1H	Axial (R1)	34

* : Under development

●2 in one-package

V _{RM} (V)	I _F (A)	I _{FSM} (A)	trr① (ns)	trr② (ns)	Part Number	Package	Page	
200	5.0	35	30	25	FMX-12S	TO-220F	26	
		35	40	30	FML-12S			
		35	100	50	FMG-12S, R			
	6.0	80	30	25	SPX-62S	Surface Mount (D Pack)		
		65	30	25	FMX-22S	TO-220F		
	10.0	65	40	30	FML-22S			
		65	40	30	MPL-102S	Surface Mount (TO-220S)		
		65	100	50	FMG-22S, R	TO-220F		
	15.0	100	30	25	FMX-22SL	FM80		
		150	30	25	FMX-32S			
		150	40	30	FML-32S			
		110	50	35	MP2-202S			Surface Mount (TO-220S)
20.0	150	100	50	FMG-32S, R	FM80			
	40	50	35	FML-13S	TO-220F			
	35	100	50	FMG-13S, R				
	10.0	70	50	35		FML-23S		
		65	100	50		FMG-23S, R		
65		30	25	FMX-23S				
20.0	65	30	25	MPX-2103	Surface Mount (TO-220S)			
	100	30	25	FMX-2203	TO-220F			
	100	50	35	FML-33S	FM80			
	150	100	50	FMG-33S, R				
100	30	25	FMX-33S					
400	5.0	40	50	35	FML-14S	TO-220F	29	
		35	100	50	FMG-14S, R			
	8.0	65	100	50	FMG-24S, R			
		10.0	70	50	FML-24S			
	16.0	100	100	50	FMG-34S, R			FM80
		100	50	35	FML-34S			
600	3.0	50	70	35	FMC-26U	TO-220F	30	
	6.0	50	100	50	FMG-26S, R			
	15.0	80	100	50	FMG-36S, R			
	20.0	100	65	35	FML-36S	FM80		
800	3.0	50	70	35	FMC-28U	TO-220F	31	
1200	3.0	50	70	35	FMC-26UA	TO-220F-2Pin	34	
1600	3.0	50	70	35	FMC-28UA			

●Bridge

V _{RM} (V)	I _F (A)	I _{FSM} (A)	trr① (ns)	trr② (ns)	Part Number	Package	Page
200	4.0	80	40	30	RBV-402L	RBV-40	26
	6.0	100	50	35	RBV-602L	RBV-60	

Selection Guide

Schottky Barrier Diodes

●1 in one-package

V _{RM} (V)	I _F (A)	V _F (V)	Part Number	Package	Page	
30	1.0	0.47	MI1A3	Surface Mount (Small)	35	
		0.39	MI2A3 *			
		0.36	SFPA-53	Surface Mount (SFP)		
		0.45	SFPJ-53 *			
		0.55	AK 03	Axial (A0)		
		0.36	EA 03	Axial (E0)		
	0.55	EK 03				
	1.5	0.55	EK 13	Axial (E1)		
	1.7	0.55	RK 13	Axial (R1)		
	2.0	0.36	SFPA-63	Surface Mount (SFP)		
			0.45			SFPJ-63
			0.55			SFPE-63 *
		0.36	RA 13	Axial (R1)		
	2.5	0.55	RK 33	Axial (R2)		
			0.36	SFPA-73		Surface Mount (SFP)
	0.45	SFPJ-73				
	0.45	RJ 43		Axial (R4)		
	0.55	RK 43				
5.0	0.45	SPJ-G53S	Surface Mount (D Pack)			
40	1.0	0.55	SFPB-54	Surface Mount (SFP)	36	
		0.55	AK 04	Axial (A0)		
		0.58	AW 04			
		0.6	AE 04			
	1.5	0.55	EK 04			Axial (E0)
			SFPB-64	Surface Mount (SFP)		
	1.7	0.55	EK 14	Axial (E1)		
			RK 14	Axial (R1)		
	2.0	0.50	SFPB-74	Surface Mount (SFP)		
			0.60			SFPE-64
		0.6	EE 04 *	Axial (E0)		
	2.5	0.55	RK 34	Axial (R2)		
			0.55	SPB-G34S		Surface Mount (D Pack)
	0.55	RK 44		Axial (R4)		
	3.0	0.55		FMB-G14		TO-220F-2Pin
			0.55	SPB-G54S		Surface Mount (D Pack)
	5.0	0.55	FMB-G14L	TO-220F-2Pin		
			0.55			FMB-G24H
60	0.7	0.62	SFPB-56	Surface Mount (SFP)	38	
		0.62	AK 06	Axial (R0)		
		0.62	EK 06	Axial (E0)		
	1.5	0.7	SFPW-56	Surface Mount (SFP)		
			0.62	EK 16		Axial (E1)
		0.62	RK 16	Axial (R1)		
	2.0	0.62	SFPB-76	Surface Mount (SFP)		
			0.69			SFPB-66
	3.5	0.62	RK 36	Axial (R2)		
			RK 46	Axial (R4)		
	5.0	0.62	FMB-G16L	TO-220F-2Pin		
	6.0	0.70	SPB-G56S	Surface Mount (D Pack)		
90	0.7	0.81	SFPB-59	Surface Mount (SFP)	39	
		0.81	AK 09	Axial (A0)		
		0.81	EK 09	Axial (E0)		
	1.5	0.81	SFPB-69	Surface Mount (SFP)		
			0.81	EK 19		Axial (E1)
	2.0	0.81	RK 19	Axial (R1)		
			RK 39	Axial (R2)		
	3.5	0.81	RK 49	Axial (R4)		
			0.81	FMB-G19L		TO-220F-2Pin

* : Under development

●2 in one-package

V _{RM} (V)	I _F (A)	V _F (V)	Part Number	Package	Page		
30	6.0	0.45	SPJ-63S	Surface Mount (D Pack)	35		
		0.45	FMJ-23L	TO-220F			
		0.45	FMJ-2203				
		0.45	FMJ-2303				
40	4.0	0.55	FMB-24	TO-220F	36		
		6.0	0.55	SPB-64S		Surface Mount (D Pack)	
	10.0		0.55	FMB-24M		TO-220F	
		0.55	FMW-24L				
	12.0	0.58	FMB-34S	FM80			
			0.60	FME-2104			
	15.0	0.60	MPE-24H	TO-220S			
			0.55	FMW-24H		TO-220F	
			0.55	FMB-24H			
			0.55	FME-24H			
	20.0	0.55	FMB-34	FM80			
			0.55	FMB-2204		TO-220F	
30.0	0.55	FMW-2204	FM80				
		0.55		FMB-2304			
60	4.0	0.62	FMB-26	TO-220F	38		
		6.0	0.65	SPB-66S		Surface Mount (D Pack)	
	10.0		0.62	FMB-26L		TO-220F	
		0.72	FME-2106				
	15.0	0.62	FMB-36	FM80			
			0.7	FMB-2206		TO-220F	
	30.0	0.7	FMB-2306	FM80			
			0.62			FMB-36M	
	90	4.0	0.81	FMB-29		TO-220F	39
			0.81	FMB-29L			
15.0		0.81	FMB-39	FM80			
			0.85	MPE-29G	TO-220S		
20.0	0.81	FMB-39M	FM80				
		100	0.85	FME-220A	TO-220F		
0.85	FME-230A						

●Bridge

V _{RM} (V)	I _F (A)	V _F (V)	Part Number	Package	Page
60	4.0	0.62	RBV-406B	RBV-40	38

Selection Guide

Damper Diodes

t_{rr} ①: I_R = I_F 90% Recovery Point
t_{rr} ②: I_R = 2 • I_F 75% Recovery Point

Application	V _{RM}	I _F	t _{rr} ①	t _{rr} ②	Part Number	Package	Page
	(V)	(A)	(μs)	(μs)			
For TV	1300	1.0	4.0	1.3	RH 2D	Axial (R2)	40
	1500	0.8	4.0	1.3	RH 10F	Axial (R1)	
		1.0	4.0	1.3	RH 2F	Axial (R2)	
		2.0	2.0	0.8	RS 3FS	Axial (R3)	
		2.5	4.0	1.3	RH 3F		
	1600		4.0	1.3	RH 4F	Axial (R4)	
		1.0	0.4	RS 4FS			
	1700	2.5	4.0	1.3	RH 3G	Axial (R3)	
	1800	6.0	2.0	0.8	FMV-G2GS	TO-220F-2Pin	
	1800	10.0	1.8	0.7	FMR-G5HS	TO-3PF-2Pin	
For CRT Display	1300	1.5	0.4	0.18	RU 4D	Axial (R4)	
		2.5	0.4	0.18	RU 4DS		
	1500	2.0	0.7	0.3	RP 3F	Axial (R3)	
		10.0	5.0	0.7	0.3	FMQ-G1FS	TO-220F-2Pin
			0.5	0.2	0.2	FMQ-G2FS	
			0.5	0.2	0.2	FMQ-G2FMS	
			0.6	0.25	0.2	FMU-G2FS	
			1.2	0.4	0.2	FMQ-G2FLS	
	0.5	0.2	0.2	FMQ-G5FMS			
	1700	10.0	0.5	0.2	FMQ-G5GS	TO-3PF-2Pin	
1800	8.0	1.0	0.4	FMP-G5HS			
For CRT Display Compensation	1300	0.5	0.1	0.05	RG 2A2	Axial (R2)	
	1600	1.0	0.07	0.035	RC 3B2	Axial (R3)	

Damper Diodes for Diode Moduration

Application	V _{RM}	I _F	t _{rr} ①	t _{rr} ②	Part Number	Package	Page
	(V)	(A)	(μs)	(μs)			
For TV	1500/600	5.0	4.0/0.4	1.3/0.18	FMV-3FU	TO-3PF	41
	1700/600	5.0	2.0/0.4	0.8/0.18	FMV-3GU		
For CRT Display	1500/600	5.0	0.7/0.1	0.3/0.05	FMP-3FU	TO-3PF	
			0.7/0.1	0.3/0.05	FMP-2FUR	TO-220F	
			2.0/0.15	0.8/0.07	FMQ-2FUR		
			1.0/0.1	—	FMT-2FUR *		
	1700/800	5.0	0.7/0.07	0.3/0.04	FMQ-3GU	TO-3PF	

* : Under development

High-Voltage Rectifier Diodes

Application	V _{RM}	I _{F (AV)}	Part Number	V _F max	t _{rr} (μs) I _F = I _{RP}		Package	Page
	(kV)	(mA)		(V)	T _a = 25°C	T _a = 100°C		
For General Purpose	2	2	SHV-02	16	0.18	—	Axial	42
	3	2	SHV-03S	16	0.18	—		
	3	2	SHV-03	16	0.18	—		
For General FBT	10	2*	SHV-10	40	0.18	—		
	12	2*	SHV-12	45	0.18	—		
	14	2*	SHV-14	55	0.18	—		
	16	2*	SHV-16	60	0.18	—		
	20	2*	SHV-20	75	0.18	—		
	24	2*	SHV-24	75	0.18	—		
For High Frequency Multi-layer FBT	6	2*	SHV-06EN	26	0.15	0.2		
	8	2*	SHV-08EN	30	0.15	0.2		
	10	2*	SHV-10EN	38	0.15	0.2		
	12	2*	SHV-12EN	45	0.15	0.2		
For Ultra-High Frequency Multi-layer FBT	8	2*	SHV-08DN	30	0.15	0.2		
	10	2*	SHV-10DN	38	0.15	0.2		
	12	2*	SHV-12DN	45	0.15	0.2		
For General Type Microwave Oven	9	350	HVR-1X-40B	9	—	—		
For Inverter Type Microwave Oven	8	350	UX-F5B	14	0.15	—		
For Automotive Ignition Coil	2.5	30	SHV-05J	5	V _Z = 2.6 to 5.0kV			
	3	30	SHV-06JN	6	V _Z = 3.2 to 6.0kV			
	4	30	SHV-08J	8	V _Z = 4.5 to 8.0kV			
	15	30	SHV-30J	30	V _Z = 16.0 to 30.0kV			

* TV High Voltage Rectifier Capacitive Load, T_c ≤ 100°C

Selection Guide

Avalanche Diodes with built-in Thyristor

V _Z (V)	V _{RDC} (V)	I _{TSM} (A)	Part Number	Package	Page
27 to 33	20	30	RZ1030	Axial (R1)	44
34 to 40	28	30	RZ1040		
50 to 60	40	30	RZ1055		
60 to 70	50	30	RZ1065		
90 to 110	80	30	RZ1100		
115 to 135	105	30	RZ1125		
140 to 160	125	30	RZ1150	Axial (E0)	
			EZ0150		
150 to 165	138.7	30	RZ1155	Axial (R1)	
165 to 185	150	30	RZ1175		
185 to 215	180	30	RZ1200		
220 to 250	179.5	30	RZ1235		
235 to 265	190	30	RZ1250		

Power Zener Diodes

V _Z (V)	P _R (W)	V _{DC} (V)	I _{ZSM} (A)	Part Number	Package	Page
28±3.0	1500	20	65.0	PZ 628	Axial	45
28±3.0	50	20	2.0	SFPZ-68	Surface Mount (SFP)	
36±3.6	450	30	11.0	SPZ-G36	Surface Mount (D Pack)	

Silicon Varistors

Division	V _F (V)	I _F (mA)	I _{FSM} (A)	Part Number	Package	Page
Symmetrical type	1.5 max	400	15	VR-60SS	Axial (E0)	46
	2.3±0.25	150	7.5	VR-61SS		
	4 max	150	—	SV-2SS		
	2 max	250	—	SV-3SS		
	1.8±0.2	150	—	SV-4SS		
Unsymmetrical type	1.2±0.2	200	30	SV 02YS	Axial (E0)	47
	1.8±0.2	150	16	SV 03YS		
	2.35±0.25	100	12	SV 04YS		
	3.0±0.3	80	10	SV 05YS		
	3.5±0.35	70	8	SV 06YS		

Symbols and Terms / trr Measurement Circuit

Symbols and Terms

V_{RSM}	Peak Reverse Surge Voltage	I_R	Reverse Current	t_{rr}	Reverse Recovery Time
V_{RM}	Peak Reverse Voltage	I_{RP}	Peak Reverse Current	C_t	Total Capacitance Between Terminals
V_{P-P}	Reverse Voltage (Peak to Peak)	$I_{R(H)}$	Reverse Current (High Temperature)	$R_{th(j-l)}$	Thermal Resistance, Junction to Lead
V_R	Reverse Voltage	I_Z	Avalanche Current	$R_{th(j-c)}$	Thermal Resistance, Junction to Case
V_F	Forward Voltage	I_{ZSM}	Allowable Avalanche Current	γ_Z	Temperature Coefficient of Breakdown Voltage
V_B	Breakdown Voltage	T_a	Ambient Temperature	R_Z	Equivalent Resistance of Breakdown region
I_F	Forward Current	T_j	Junction Temperature	$P_{F(AV)}$	Average Forward Power Dissipation
$I_{F(AV)}$	Average Forward Current	T_{opr}	Operating Ambient Temperature	I^2t	I^2t Limiting Value
I_{FSM}	Peak Forward Surge Current	T_c	Case Temperature		
I_{RSM}	Peak Reverse Surge Current	T_{stg}	Storage Temperature		

trr (Reverse Recovery Time) Measurement Circuit

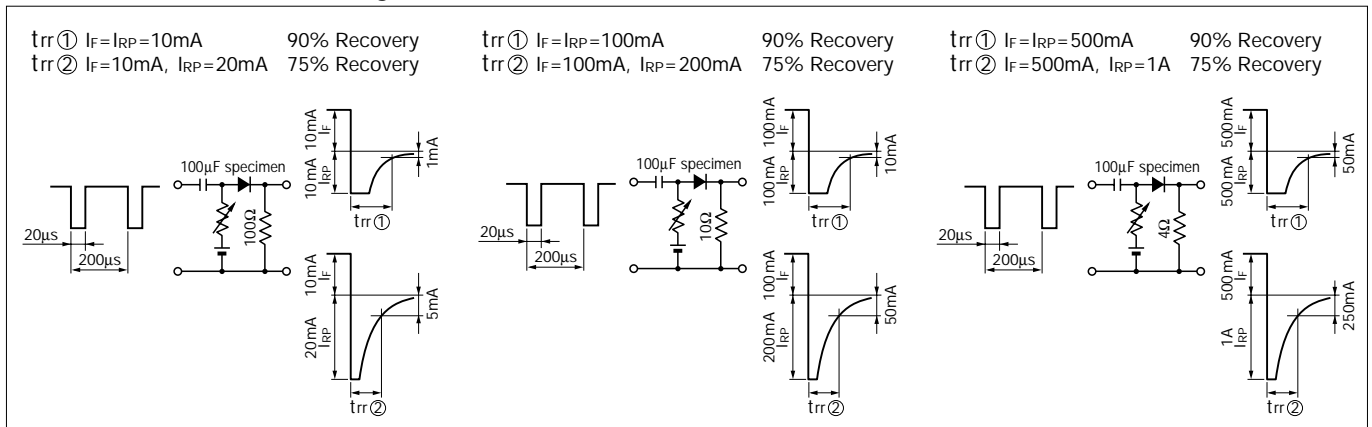

Taping Specifications

Taping name	Taping Dimensions (mm)	Package Dimensions (mm) and Markings	Quantity
V The suffix "V" is added to the Part Number		Reel 	5,000 pcs/reel (2.7φ body) (2.4φ body) 3,000 pcs/reel (4φ body)
V1 The suffix "V1" is added to the Part Number		Ammunition (Ammo) pack 	2,000 pcs/box (2.7φ body) 3,000 pcs/box (2.4φ body) 1,000 pcs/box (4φ body)

Taping Specifications

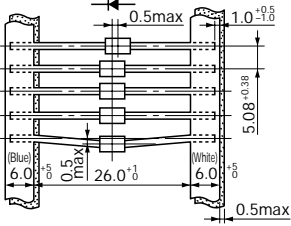
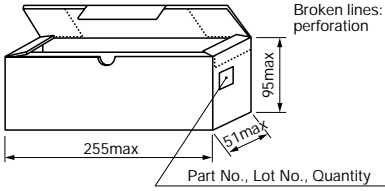
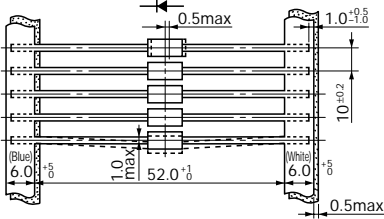
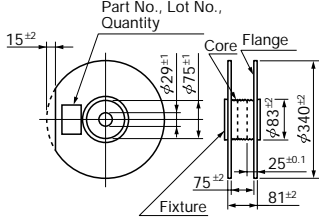
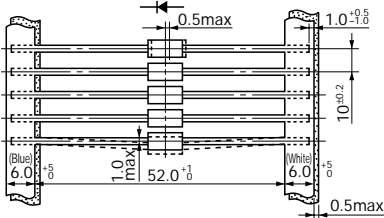
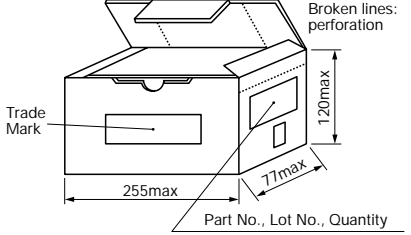
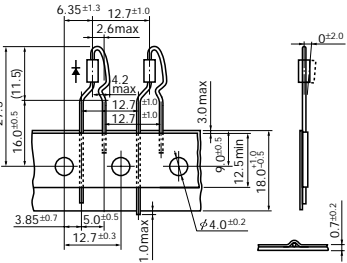
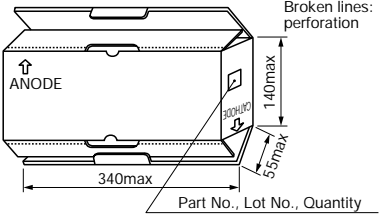
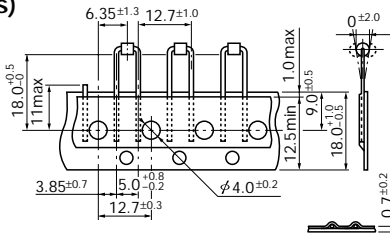
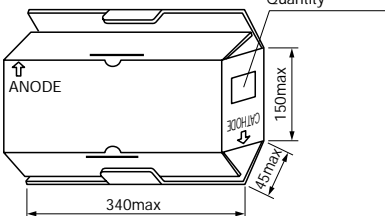
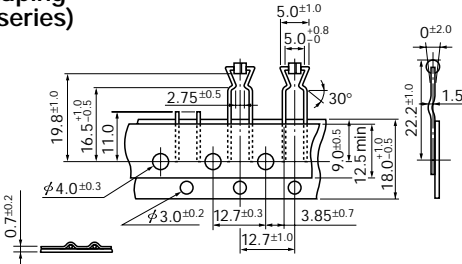
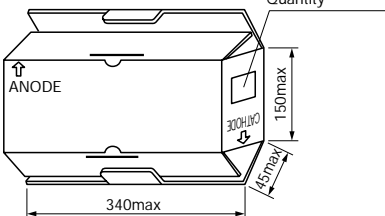
Taping name	Taping Dimensions (mm)	Package Dimensions (mm) and Markings	Quantity
<p>V0</p> <p>The suffix "V0" is added to the Part Number</p>	<p>Axial taping</p> 	<p>Ammunition (Ammo) pack</p> 	<p>2,000 pcs/box (2.7 φ body)</p> <p>3,000 pcs/box (2.4 φ body)</p>
<p>V3</p> <p>The suffix "V3" is added to the Part Number</p>	<p>Axial taping</p> 	<p>Reel</p> 	<p>1,500 pcs/reel (5.2 φ body)</p>
<p>V4</p> <p>The suffix "V4" is added to the Part Number</p>	<p>Axial taping</p> 	<p>Ammunition (Ammo) pack</p> 	<p>1,000 pcs/box (5.2 φ body)</p>
<p>W</p> <p>The suffix "W" is added to the Part Number</p>	<p>Radial taping</p> 	<p>Ammunition (Ammo) pack</p> 	<p>4,000 pcs/box (2.7 φ body) (0.6 φ lead only)</p>
<p>WS</p> <p>The suffix "WS" is added to the Part Number</p>	<p>Radial taping (for A0 series)</p> 	<p>Ammunition (Ammo) pack</p> 	<p>2,500 pcs/box (2.4 φ body)</p>
<p>WK</p> <p>The suffix "WK" is added to the Part Number</p>	<p>Radial taping (for A0 series)</p> 	<p>Ammunition (Ammo) pack</p> 	<p>2,500 pcs/box (2.4 φ body)</p>

Taping Specifications for Surface Mount

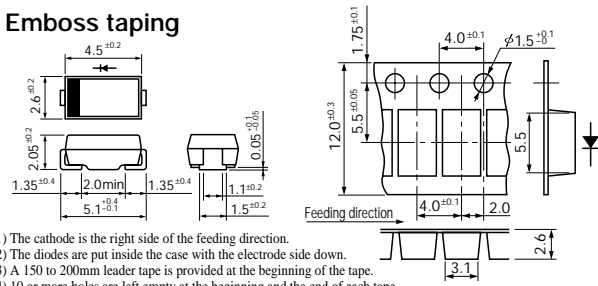
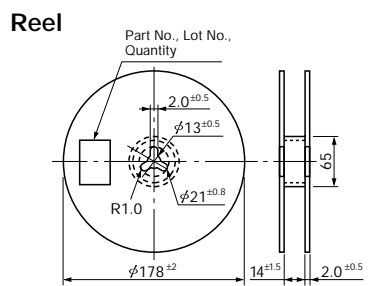
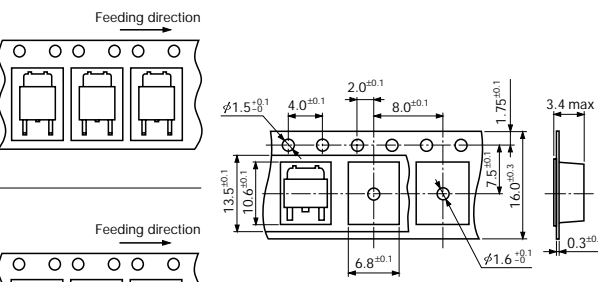
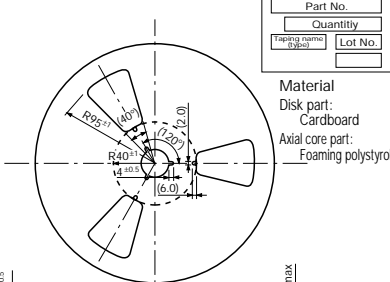
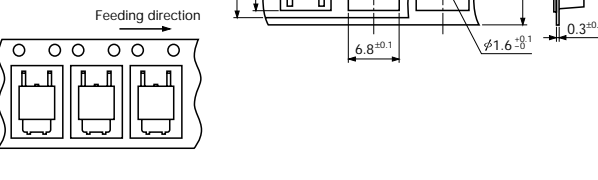
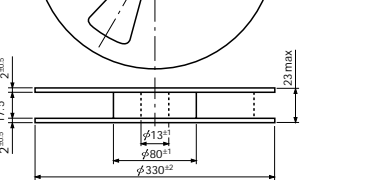
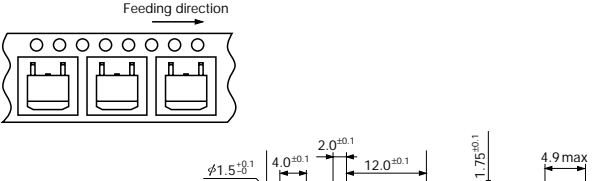
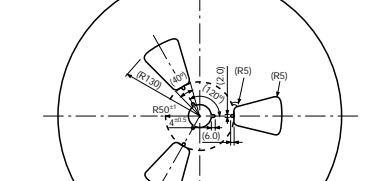
Taping name	Taping Dimensions (mm)	Package Dimensions (mm) and Markings	Quantity
SFP	V  <p>The suffix "V" is added to the Part Number</p> <p>(1) The cathode is the right side of the feeding direction. (2) The diodes are put inside the case with the electrode side down. (3) A 150 to 200mm leader tape is provided at the beginning of the tape. (4) 10 or more holes are left empty at the beginning and the end of each tape. (5) Taping of diodes with electrodes facing the direction is also available (taping name: VL)</p>	Reel  <p>Part No., Lot No., Quantity</p> <p>Material Disk part: Cardboard Axial core part: Foaming polystyrene</p>	1,800 pcs/reel
	VL <p>The suffix "VL" is added to the Part Number</p> 		3,000 pcs/reel
D Pack	VR <p>The suffix "VR" is added to the Part Number</p> 		3,000 pcs/reel
	VR <p>The suffix "VR" is added to the Part Number</p> 		1,000 pcs/reel

Taping Specifications for High-Voltage Diodes

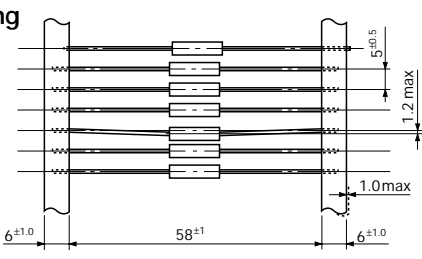
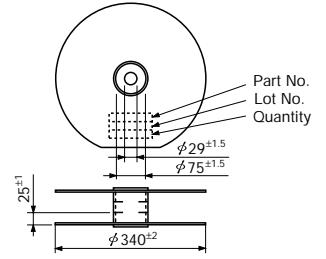
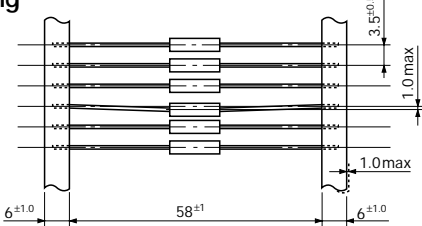
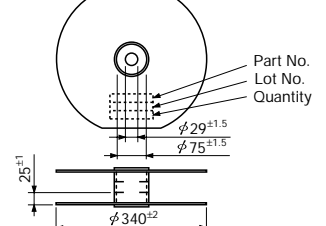
Taping name	Taping Dimensions (mm)	Package Dimensions (mm) and Markings	Quantity
V1 <p>The suffix "V1" is added to the Part Number</p>	Axial taping 	 <p>Part No., Lot No., Quantity</p>	5,000 pcs/reel
VD <p>The suffix "VD" is added to the Part Number</p>	Axial taping 	 <p>Part No., Lot No., Quantity</p>	8,000 pcs/reel

Marking Guide

Note: high-voltage rectifier diodes shall have different specifications.

1 Axial (A0)

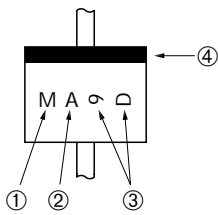

- Part Number (abbreviation)
The AM01 is indicated as "M."
- Class
Z: 200V None: 400V A: 600V
B: 800V C: 1000V
- Manufacturing date
First character: Year (Last digit of year)
Second character: Month (1 to 9, O, N, D)
- Cathode band: Continuous band
Color of markings: White
(Yellow for AU02 series)

2 Axial (E0, E1)

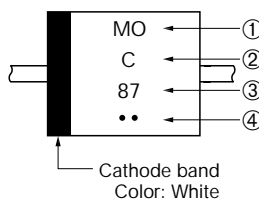

- Part Number (abbreviation)
EM01, EM2, EM1 are indicated as MO, M2 and M1, respectively.
- Class
Z: 200V None: 400V A: 600V
B: 800V C: 1000V F: 1500V
But EU02A is indicated as A2 and EU2YX as Y.
- Manufacturing date
First character: Year (Last digit of year)
Second character: Month (1 to 9, O, N, D)
- Manufacturing period
• First 10 days of month
•• Middle 10 days of month
••• Last 10 days of month

3 Axial (R1, R2, R3, R4)

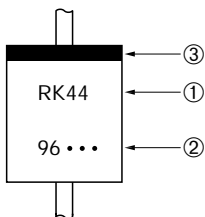

- Part Number: 2 set marking
- Manufacturing date and period: 2 set marking
First character: Year (Last digit of year)
Second character: Month (1 to 9, O, N, D)
• First 10 days of month
•• Middle 10 days of month
••• Last 10 days of month
- Cathode band
Color of markings:

White:	For Power Supply and SBD
Yellow:	For Medium speed
Red:	For High-speed and ultra high-speed

4 RBV

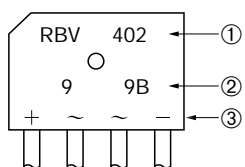

- Part Number
- Lot No.
First character: Year (Last digit of year)
Second character: Month (1 to 9, O, N, D)
Third character: A—First 10 days of month
B—Middle 10 days of month
C—Last 10 days of month
- Input/output marking
Laser marking or White marking

5 TO-220F Type

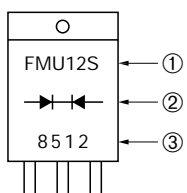

- Part Number
FMU-12S is indicated as "FMU12S."
- Polarity: Rectifier Symbol
- Lot No.
First character: Year (Last digit of year)
Second character: Month (1 to 9, O, N, D)
Third and fourth characters: Day
Laser marking or White marking

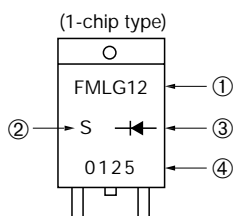

- Part Number: Excluding last character
FML-G12S is indicated as "FML-G12."
- Last character of Part Number
- Polarity: Rectifier Symbol
- Lot No.
First character: Year (Last digit of year)
Second character: Month (1 to 9, O, N, D)
Third and fourth characters: Day
Laser marking or White marking

6 TO-3PF, FM80 Type

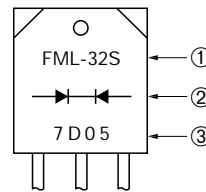

- Part Number: Full name
- Polarity: Rectifier Symbol
- Lot No.
First character: Year (Last digit of year)
Second character: Month (1 to 9, O, N, D)
Third and fourth characters: Day
Laser marking or White marking

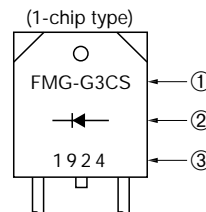

7 Surface Mount (SFP)

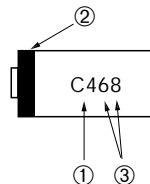

- Part Number: abbreviation
SFPB-64 is indicated as "C4"
- Cathode band
- Lot No.
First character: Year (Last digit of year)
Second character: Month (1 to 9, O, N, D)

8 Surface Mount (D Pack)

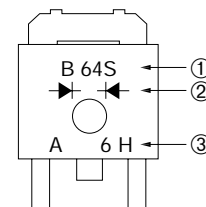

- Part Number
- Polarity: Rectifier Symbol
- Lot No.
First character: Lot code
Second character: Year (Last digit of year)
Third character: Month (A to M except I)

9 Surface Mount (TO-220S)

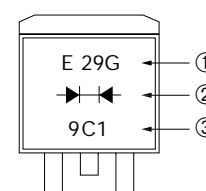

- Part Number
- Polarity: Rectifier Symbol
- Lot No.
First character: Year (Last digit of year)
Second character: Month (A to M except I)
Third character: Week

10 High-Voltage Rectifier Diode

Refer P42 to P43

11 Silicon Varistors

Refer P46 to P47

Rectifier Diodes

100V

V _{RM} (V)	Package	Part Number	I _F (AV) (A) () is with Heatsink	I _{FSM} (A)	T _J (°C)	T _{stg} (°C)	V _F (V) max	I _F (A)	I _R (μA)	I _R (H) (μA)	R _{th} (j-l) R _{th} (j-c) (°C/W)	Mass (g)	Fig. No.	Page where characteristic curve is shown
				50Hz Half-cycle Sinewave Single Shot					V _R = V _{RM} max	V _R = V _{RM} max				
100	Axial	EM 1Y	1.0	45	-40 to +150	0.97	1.0	10	50	100	17	0.3	1	48
		RM 4Y	1.7 (3.0)	200	-40 to +150	0.95	3.0	10	50	100	8	1.2	2	50
	Center-tap	FMM-31S, R	20	120	-40 to +150	1.1	10	10	100	100	2.0	5.5	3	51
	Bridge	RBV-401	4.0	80	-40 to +150	1.05	2.0	10	100	100	5.0	4.05	4	51
		RBV-601	6.0	120	-40 to +150	1.0	3.0	10	100	100	3.0	6.45	5	52

External Dimensions Flammability: UL94V-0 or Equivalent (Unit: mm)

1

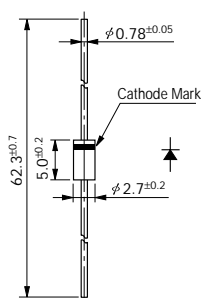

2

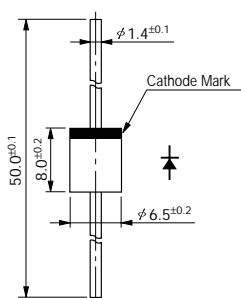

3

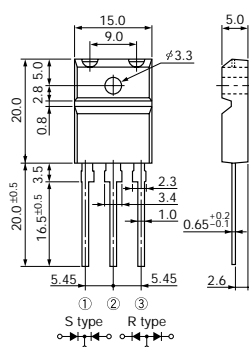

4

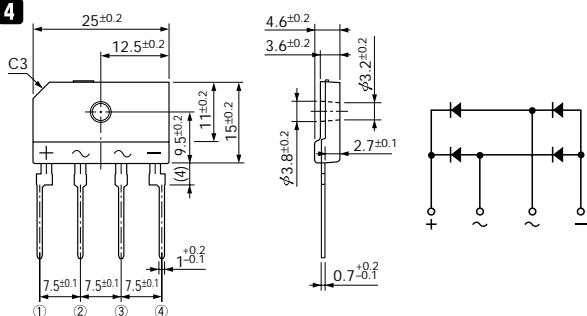

5

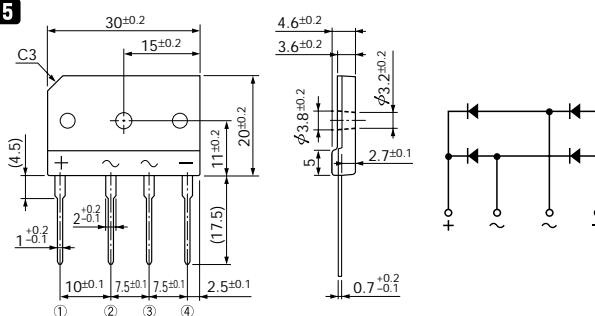

Rectifier Diodes

200V

V _{RM} (V)	Package	Part Number	I _F (AV) (A)	I _{FSM} (A)	T _J (°C)	T _{stg} (°C)	V _F (V) max	I _F (A)	I _R (μA)	I _R (H) (μA)	R _{th(j-l)} R _{th(j-c)} (°C/W)	Mass (g)	Fig. No.	Page where characteristic curve is shown
			() is with Heatsink	50Hz Half-cycle Sinewave Single Shot					V _R = V _{RM} max	V _R = V _{RM} max				
200	Surface Mount	SFPM-52	0.9	30	-40 to +150	1.0	1.0	10	50	100	20	0.072	1	48
		SFPM-62	1.0	45	-40 to +150	0.98	1.0	10	50	100	20	0.072		
	Axial	AM01Z	1.0	35	-40 to +150	0.98	1.0	10	50	100	22	0.13	2	48
		EM01Z	1.0	45	-40 to +150	0.97	1.0	10	50	100	20	0.2		
		EM 1Z	1.0	45	-40 to +150	0.97	1.0	10	50	100	17	0.3	4	49
		RM 1Z	1.0	50	-40 to +150	0.95	1.0	5	50	100	15	0.4		
		RM 10Z	1.5	120	-40 to +150	0.91	1.5	10	50	100	15	0.4	5	50
		RO 2Z	1.2	80	-40 to +150	0.92	1.5	10	50	100	12	0.61		
		RM 2Z	1.2	100	-40 to +150	0.91	1.5	10	50	100	12	0.6	6	49
	RM 4Z	1.7 (3.0)	200	-40 to +150	0.95	3.0	10	50	100	8	1.2	7		
	Center-tap	FMM-22S, R	10	100	-40 to +150	1.1	5.0	10	100	100	4.0	2.1	8	50
FMM-32S, R		20	120	-40 to +150	1.1	10	10	100	100	2.0	5.5	9	51	
Bridge	RBV-402	4.0	80	-40 to +150	1.05	2.0	10	100	100	5.0	4.05	10	51	
	RBV-602	6.0	120	-40 to +150	1.0	3.0	10	100	100	3.0	6.45	11	52	
	RBV-4102	10	80	-40 to +150	1.1	5.0	10	100	150(T _J)	2.0	4.05	10	—	

External Dimensions

Flammability: UL94V-0 or Equivalent (Unit: mm)

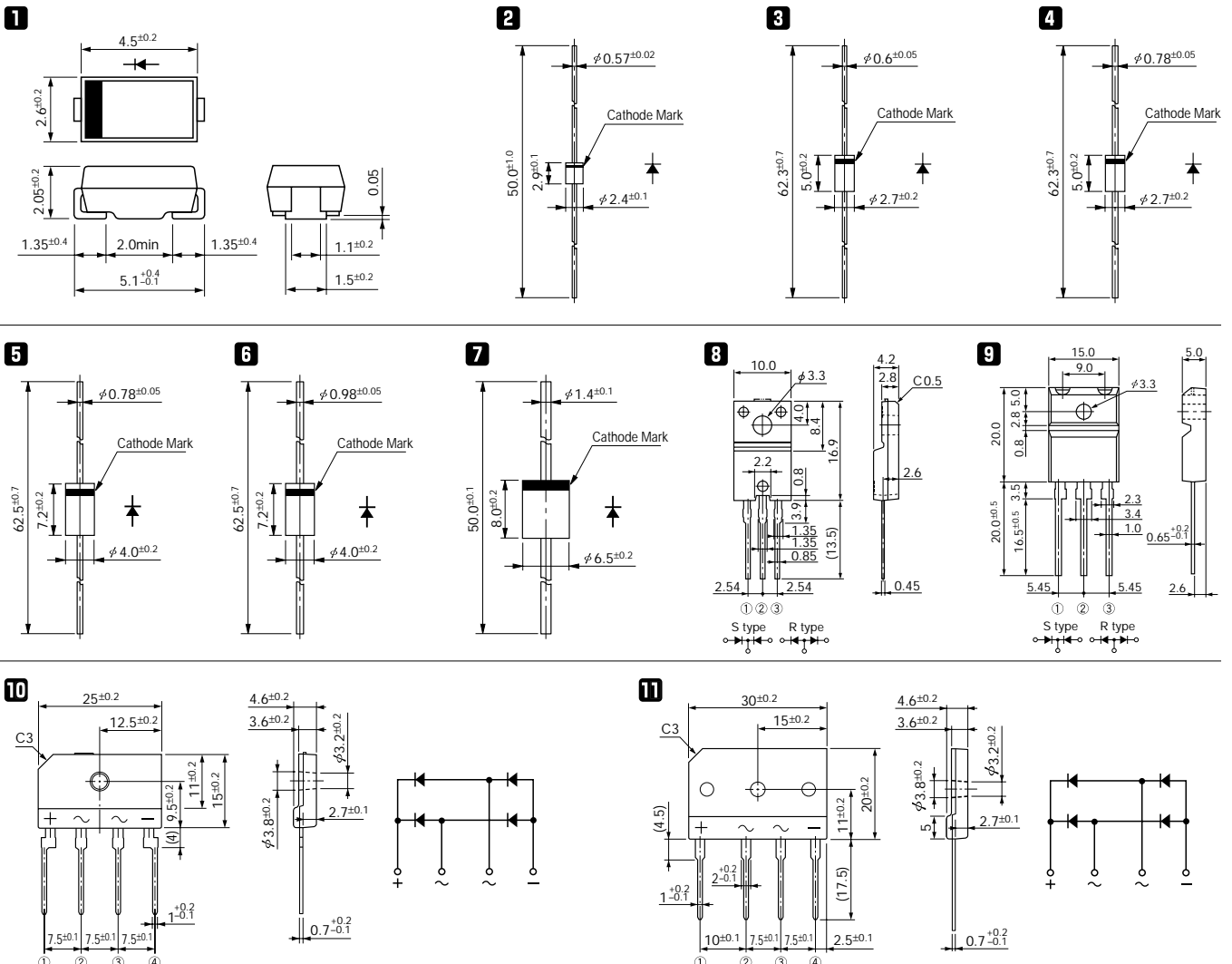

Rectifier Diodes

400V

V _{RM} (V)	Package	Part Number	I _F (A) () is with Heatsink	I _{FSM} (A)	T _J (°C)	T _{stg} (°C)	V _F (V) max	I _F (A)	I _R (μA)	I _R (H) (μA)	R _{th(j-l)} R _{th(j-c)} (°C/W)	Mass (g)	Fig. No.	Page where characteristic curve is shown	
				50Hz Half-cycle Sinewave Single Shot					V _R = V _{RM} max	V _R = V _{RM} max					
400	Surface Mount	SFPM-54	0.9	30	-40 to +150	1.0	1.0	10	10	100	20	0.072	1	48	
		SFPM-64	1.0	45	-40 to +150	0.98	1.0	10	50	100	20	0.072		54	
		SFPM-74	1.0	50	-40 to +150	1.0	1.0	10	50	150	20	0.072			
	Axial	AM01	1.0	35	-40 to +150	0.98	1.0	10	50	100	22	0.13	2	48	
		EM01	1.0	45	-40 to +150	0.97	1.0	10	50	100	20	0.2			3
		EM 1	1.0	45	-40 to +150	0.97	1.0	10	50	100	17	0.3			
		RM 1	1.0	50	-40 to +150	0.95	1.0	5	50	100	15	0.4	5	49	
		EM 2	1.2	80	-40 to +150	0.92	1.2	10	50	100	17	0.3			4
		RM 10	1.2	150	-40 to +150	0.91	1.5	10	50	100	15	0.4	5		
		RM 2	1.2	100	-40 to +150	0.91	1.5	10	50	100	12	0.6		6	
		RO 2	1.2	80	-40 to +150	0.92	1.5	10	50	100	12	0.61	6		
		RM 3	2.5	150	-40 to +150	0.95	2.5	10	100	150	10	1.0		7	50
	RM 4	1.7 (3.0)	200	-40 to +150	0.95	3.0	10	50	100	8	1.2	8			
	Center-tap	FMM-24S, R	10	100	-40 to +150	1.1	5.0	10	100	100	4.0		2.1	9	50
FMM-34S, R		20	120	-40 to +150	1.1	10	10	100	100	2.0	5.5	10	51		
Bridge	RBV-404	4.0	80	-40 to +150	1.1	2.0	10	100	100	5.0	4.05		11	51	
	RBV-604	6.0	150	-40 to +150	1.05	3.0	10	100	100	3.0	6.45	12		52	

External Dimensions

Flammability: UL94V-0 or Equivalent (Unit: mm)

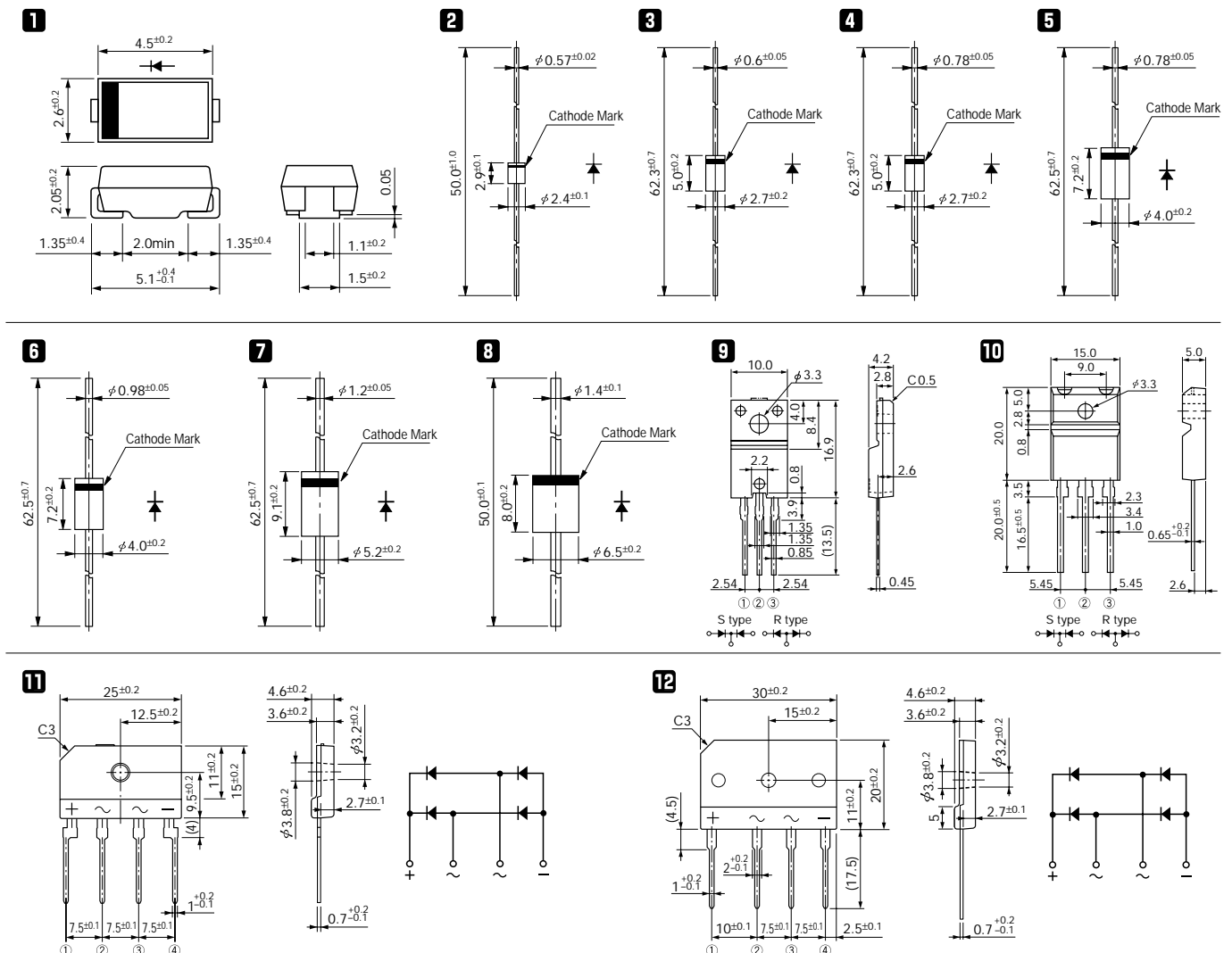

Rectifier Diodes

600V

V _{RM} (V)	Package	Part Number	I _F (A) () is with Heatsink	I _{FSM} (A) 50Hz Half-cycle Sinewave Single Shot	T _J (°C)	T _{stg} (°C)	V _F (V) max	I _F (A)	I _R (μA) V _R = V _{RM} max	I _R (H) (μA) V _R = V _{RM} max	T _a (°C)	R _{th(j-l)} R _{th(j-c)} (°C/W)	Mass (g)	Fig. No.	Page where characteristic curve is shown
600	Axial	AM01A	1.0	35	-40 to +150	0.98	1.0	10	50	100	22	0.13	1	48	
		EM01A	1.0	45	-40 to +150	0.97	1.0	10	50	100	20	0.2	2		
		EM 1A	1.0	45	-40 to +150	0.97	1.0	10	50	100	17	0.3	3		
		RM 1A	1.0	50	-40 to +150	0.95	1.0	5	50	100	15	0.4	4	49	
		EM 2A	1.2	80	-40 to +150	0.92	1.2	10	50	100	17	0.3	3		
		RM 11A	1.2	100	-40 to +150	0.92	1.5	10	50	100	15	0.4	4		
		RM 10A	1.2	150	-40 to +150	0.91	1.5	10	50	100	15	0.4	4	50	
		RM 2A	1.2	100	-40 to +150	0.91	1.5	10	50	100	12	0.6	5		
		RO 2A	1.2	80	-40 to +150	0.92	1.5	10	50	100	12	0.61	5		
		RM 3A	2.5	150	-40 to +150	0.95	2.5	10	100	100	10	1.0	6	50	
	RM 4A	1.7 (3.0)	200	-40 to +150	0.95	3.0	10	50	100	8	1.2	7			
	RM 4AM	1.8 (3.2)	350	-40 to +150	0.92	3.5	10	50	100	8	1.2	7			
	Center-tap	FMM-26S, R	10	100	-40 to +150	1.1	5.0	10	100	100	4.0	2.1	8	50	
		FMM-36S, R	20	120	-40 to +150	1.1	10	10	100	100	2.0	5.5	9	51	
	Bridge	RBV-406	4.0	80	-40 to +150	1.1	2.0	10	100	100	5.0	4.05	10	51	
		RBV-406H	4.0	120	-40 to +150	0.92	2.0	10	100	100	5.0	4.05	10	52	
		RBV-406M	4.0	120	-40 to +150	1.0	2.0	10	100	100	5.0	4.05	10	51	
		RBV-606	6.0	120	-40 to +150	1.05	3.0	10	100	100	3.0	6.45	11	52	
		RBV-606H	6.0	140	-40 to +150	1.05	3.0	10	200	100	3.0	6.45	11	52	
		RBV-4086H	8.0	120	-40 to +150	1.1	4.0	10	100	100(Tj)	2.0	4.05	10	54	
RBV-4106M		10	120	-40 to +150	1.0	5.0	10	100	100	2.0	4.05	10	54		
RBV-1306		13	80	-40 to +150	1.2	6.5	10	100	100	1.5	6.45	11	53		
RBV-1506S		15	150	-40 to +150	1.1	7.5	10	200	100	1.5	6.45	11			
RBV-1506J		15	150	-40 to +175	1.1	7.5	10	200	150(Tj)	1.5	6.45	11			
RBV-1506	15	200	-40 to +150	1.05	7.5	50	200	100	1.5	6.45	11	54			
RBV-2506	25	350	-40 to +150	1.05	12.5	50	200	100	1.5	6.45	11	54			

External Dimensions

Flammability: UL94V-0 or Equivalent (Unit: mm)

* : Under development

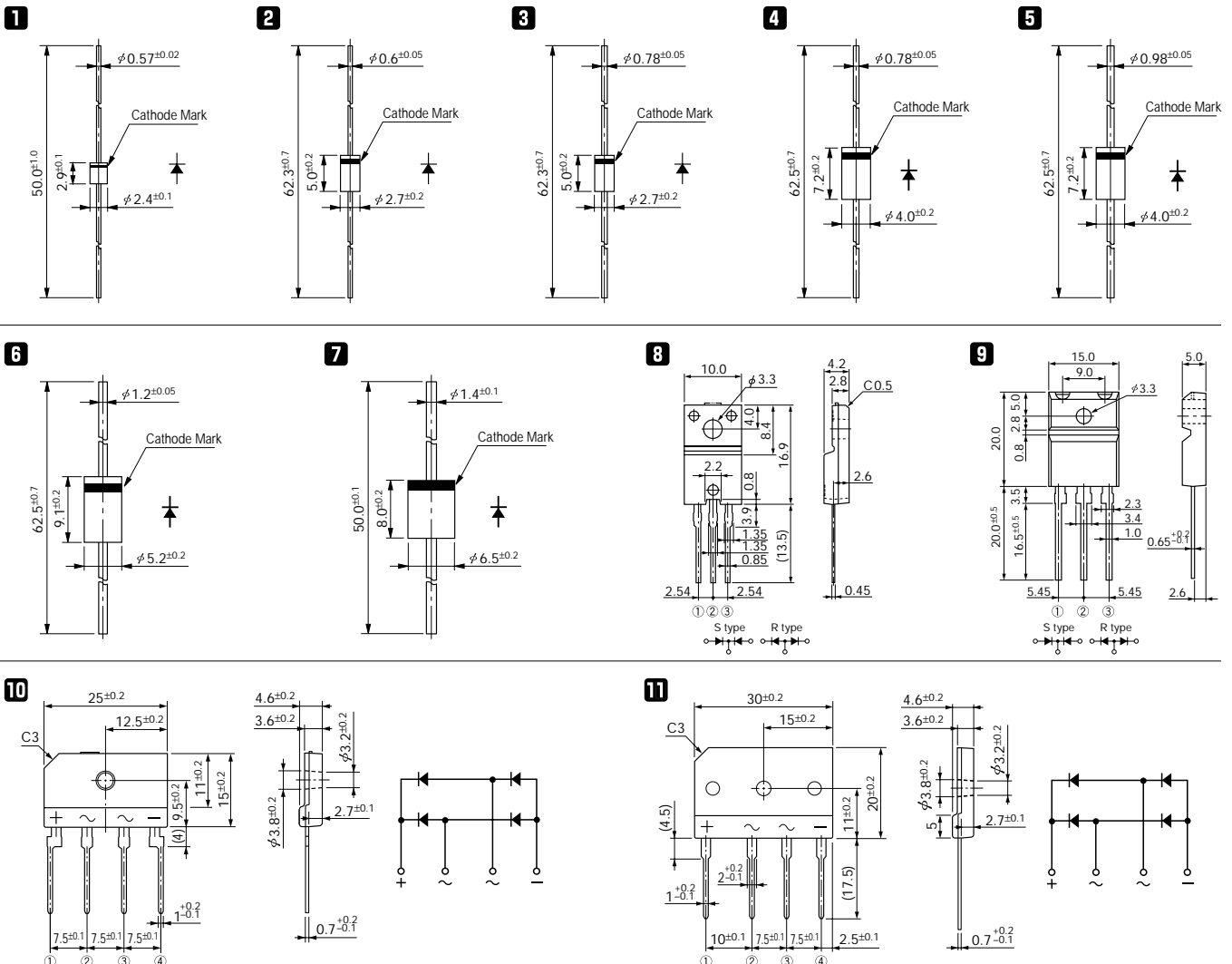

Rectifier Diodes

800V

V _{RM} (V)	Package	Part Number	I _F (A _V) (A)	I _{FSM} (A)	T _J (°C)	T _{stg} (°C)	V _F (V) max	I _F (A)	I _R (μA)	I _R (H) (μA)	R _{th(j-l)} R _{th(j-c)} (°C/W)	Mass (g)	Fig. No.	Page where characteristic curve is shown
			() is with Heatsink	50Hz Half-cycle Sinewave Single Shot					V _R = V _{RM} max	V _R = V _{RM} max				
800	Axial	RM 1B	0.8	40	-40 to +150	1.2	1.0	5	50	100	15	0.4	2	49
		EM 1B	1.0	35	-40 to +150	0.97	1.0	20	100	100	17	0.3	1	48
		EM 2B	1.2	80	-40 to +150	0.92	1.2	10	50	100	17	0.3		
		RM 11B	1.2	100	-40 to +150	0.92	1.5	10	50	100	15	0.4	2	49
		RM 10B	1.2	150	-40 to +150	0.91	1.5	10	50	100	15	0.4		
		RM 2B	1.2	100	-40 to +150	0.91	1.5	10	50	100	12	0.6	3	
		RO 2B	1.2	80	-40 to +150	0.92	1.5	10	50	100	12	0.61		
		RM 3B	2.5	120	-40 to +150	0.95	2.5	10	100	150	10	1.0	4	50
		RM 4B	1.7 (3.0)	150	-40 to +150	0.95	3.0	10	50	100	8	1.2	5	
	Bridge	RBV-408	4.0	100	-40 to +150	1.0	2.0	10	50	100	5.0	4.05	6	51
RBV-608	6.0	170	-40 to +150	0.95	3.0	10	100	100	3.0	6.45	7	52		

External Dimensions

Flammability: UL94V-0 or Equivalent (Unit: mm)

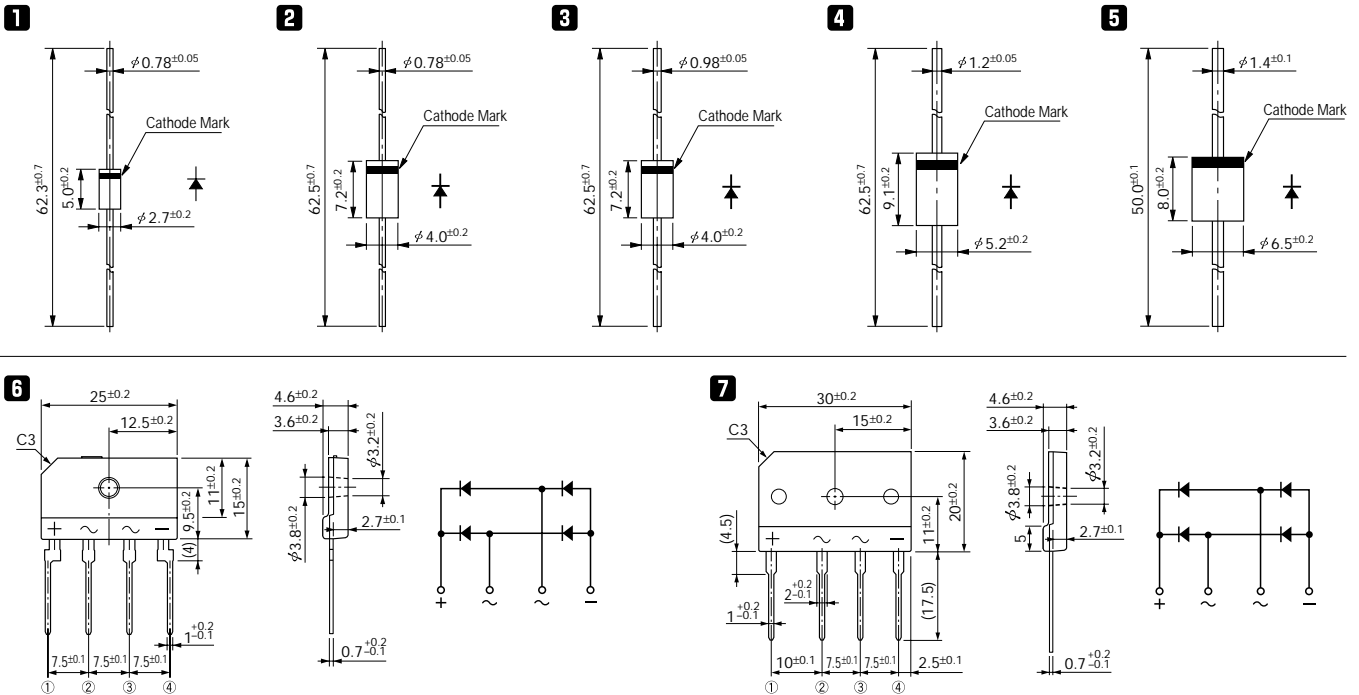

Rectifier Diodes

1000V

V _{RM} (V)	Package	Part Number	I _F (AV) (A) () is with Heatsink	I _{FSM} (A)	T _J (°C)	T _{stg} (°C)	V _F (V) max	I _F (A)	I _R (μA)	I _R (H) (μA)	R _{th} (j-ℓ) R _{th} (j-c) (°C/W)	Mass (g)	Fig. No.	Page where characteristic curve is shown
				50Hz Half-cycle Sinewave Single Shot					V _R = V _{RM} max	V _R = V _{RM} max				
1000	Axial	RM 1C	0.8	40	-40 to +150	1.2	1.0	5	50	100	15	0.4	2	49
		EM 1C	1.0	35	-40 to +150	0.97	1.0	20	100	100	17	0.3	1	48
		RM 11C	1.2	100	-40 to +150	0.92	1.5	10	50	100	15	0.4	2	49
		RM 2C	1.2	100	-40 to +150	0.91	1.5	10	50	100	12	0.6	3	
		RO 2C	1.2	80	-40 to +150	0.92	1.5	10	50	100	12	0.61	4	50
		RM 3C	2.0	150	-40 to +150	0.95	2.5	10	100	150	10	1.0		
	RM 4C	1.7 (3.0)	150	-40 to +150	0.95	3.0	10	50	100	8	1.2	5		
	Bridge	RBV-40C	4.0	100	-40 to +150	1.0	2.0	10	50	100	5.0	4.05	6	51
RBV-150C *		15	200	-40 to +150	1.05	7.5	50	200	100(TJ)	1.5	6.45	7	54	

* : Under development

External Dimensions

Flammability: UL94V-0 or Equivalent (Unit: mm)

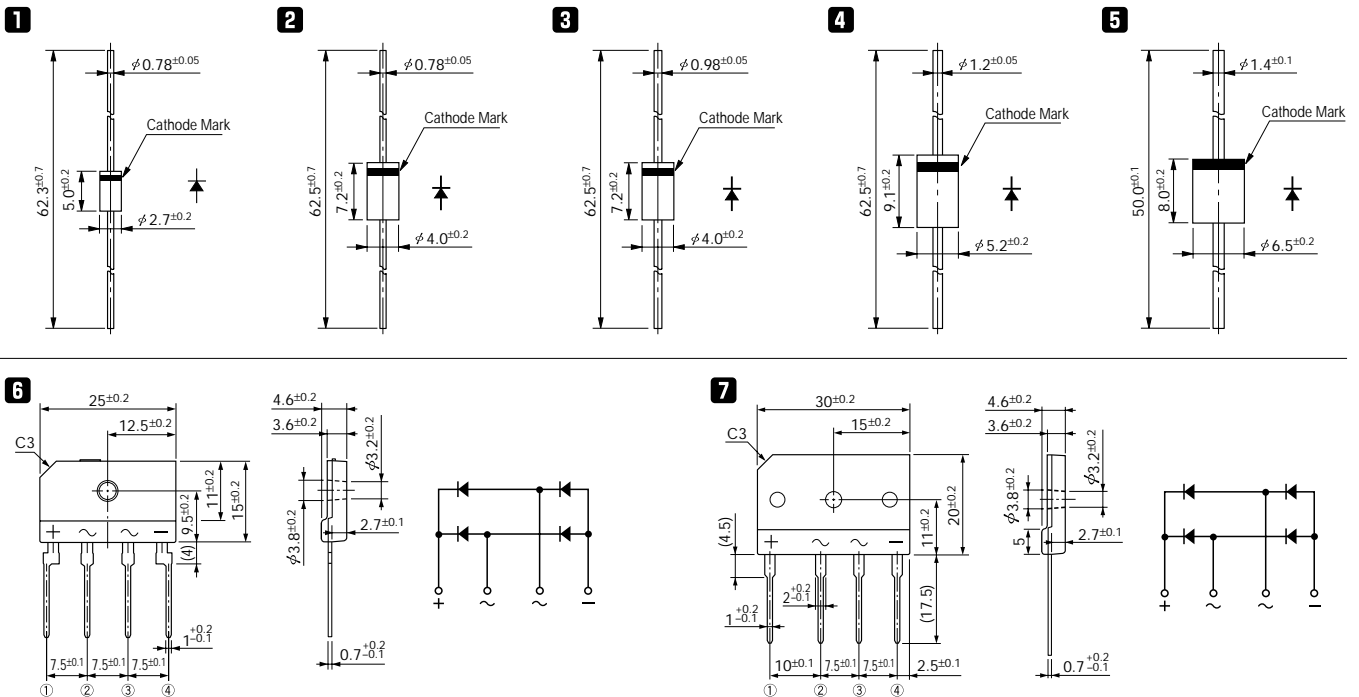

Fast-Recovery Rectifier Diodes 100V

$t_{rr} \text{ ①: } I_F/I_R (=I_F) \text{ 90\% Recovery Point}$
 (ex. $I_F/I_R = 100\text{mA}/100\text{mA}$ 90% Recovery Point)
 $t_{rr} \text{ ②: } I_F/I_R (=2 I_F) \text{ 75\% Recovery Point}$
 (ex. $I_F/I_R = 100\text{mA}/200\text{mA}$ 75% Recovery Point)

V_{RM} (V)	Package	Part Number	I_F (AV) (A) () is with Heatsink	I_{FSM} (A)	T_j (°C)	T_{stg} (°C)	V_F (V) max	I_F (A)	I_R (μ A)	I_R (H) (μ A)	T_a (°C)	t_{rr} ① (μ s)		t_{rr} ② (μ s)		$R_{th(j-l)}$ $R_{th(j-c)}$ (°C/W)	Mass (g)	Fig. No.	Page where characteristic curve is shown
				50Hz Half-cycle Sinewave Single Shot					$V_R = V_{RM}$ max	$V_R = V_{RM}$ max		I_F/I_{FP} (mA)	I_F/I_{FP} (mA)						
100	Axial	EU 2YX	1.2	25	-40 to +150	0.9	1.2	10	300	100	0.2	10/10	0.08	10/20	17	0.3	1	57	59
		RU 2YX	1.5	30	-40 to +150	0.95	1.5	10	300	100	0.2	10/10	0.08	10/20	15	0.4	2	58	
		RU 3YX	2.0	50	-40 to +150	0.95	2.0	10	300	100	0.2	10/10	0.08	10/20	12	0.6	3	59	
		RU 30Y	1.5 (3.5)	100	-40 to +150	0.97	3.5	10	300	100	0.4	10/10	0.18	10/20	10	1.0	4	60	
		RU 4Y	2.0 (3.5)	70	-40 to +150	1.3	3.5	10	300	100	0.4	10/10	0.18	10/20	8	1.2	5	60	
		RU 4YX	2.2 (4.0)	100	-40 to +150	1.3	3.5	10	300	100	0.4	100/100	0.18	100/200	8	1.2	5	60	
	Frame-2Pin	FMU-G2YXS	10	100	-40 to +150	1.0	10	50	500	100	0.2	100/100	0.08	100/200	4.2	2.1	6	61	
Center-tap	FMU-21S, R	10	40	-40 to +150	1.5	5.0	50	500	100	0.4	100/100	0.18	100/200	4.0	2.1	7	62		

External Dimensions Flammability: UL94V-0 or Equivalent (Unit: mm)

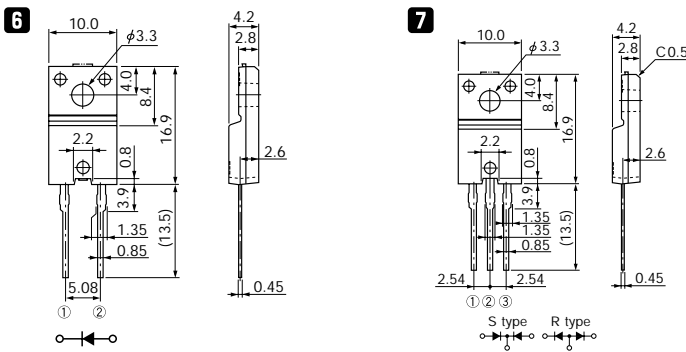
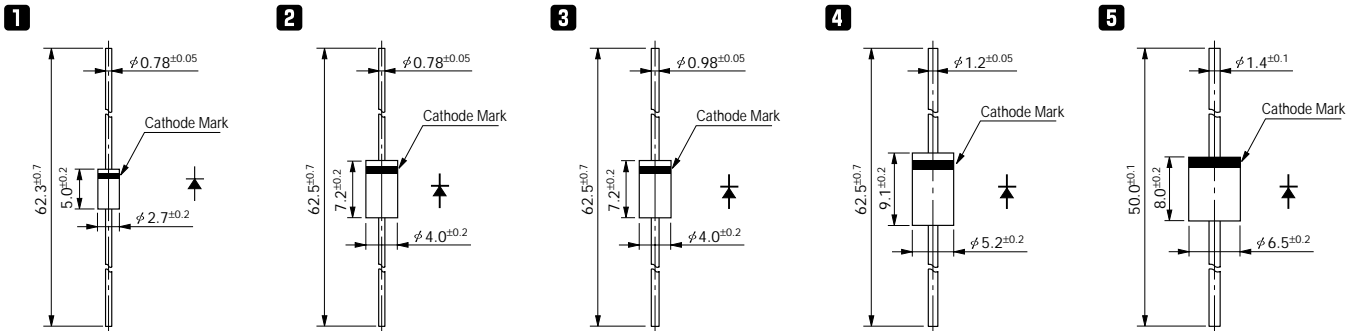

Fast-Recovery Rectifier Diodes 200V

$t_{rr} \textcircled{1}$: $I_F/I_R (=I_F)$ 90% Recovery Point
 (ex. $I_F/I_R = 100\text{mA}/100\text{mA}$ 90% Recovery Point)
 $t_{rr} \textcircled{2}$: $I_F/I_R (=2 I_F)$ 75% Recovery Point
 (ex. $I_F/I_R = 100\text{mA}/200\text{mA}$ 75% Recovery Point)

V_{RM} (V)	Package	Part Number	I_F (AV) (A) () is with Heatsink	I_{FSM} (A) 50Hz Half-cycle Sinewave Single Shot	T_j (°C)	T_{stg} (°C)	V_F (V) max	I_F (A)	I_R (μ A)	I_R (H) (μ A) max	T_a (°C)	$t_{rr} \textcircled{1}$ (μ s)		$t_{rr} \textcircled{2}$ (μ s)		$R_{th} (j-l)$ $R_{th} (j-c)$ (°C/W)	Mass (g)	Fig. No.	Page where characteristic curve is shown
												I_F/I_{FP} (mA)	I_F/I_{FP} (mA)						
200	Axial	EU01Z	0.25	15	-40 to +150	2.5	0.25	10	150	100	0.4	10/10	0.18	10/20	20	0.2	2	55	
		EU 1Z	0.25	15	-40 to +150	2.5	0.25	10	150	100	0.4	10/10	0.18	10/20	17	0.3	3	56	
		AU01Z	0.5	15	-40 to +150	1.7	0.5	10	150	100	0.4	10/10	0.18	10/20	22	0.13	1	55	
		AS01Z	0.6	20	-40 to +150	1.5	0.6	10	50	100	1.5	10/10	0.6	10/20	22	0.13	1	55	
		EH 1Z	0.6	30	-40 to +150	1.35	0.6	10	200	150	4	10/10	1.3	10/20	17	0.3	3	56	
		RF 1Z	0.6	15	-40 to +150	2.0	0.6	10	200	100	0.4	10/10	0.18	10/20	15	0.4	4	57	
		RH 1Z	0.6	35	-40 to +150	1.3	0.6	5	70	150	4	10/10	1.3	10/20	15	0.4	4	57	
		ES01Z	0.7	30	-40 to +150	2.5	0.8	10	200	100	1.5	10/10	0.6	10/20	20	0.2	2	55	
		ES 1Z	0.7	30	-40 to +150	2.5	0.8	10	200	100	1.5	10/10	0.6	10/20	17	0.3	3	56	
		AU02Z	0.8	25	-40 to +150	1.3	0.8	10	250	100	0.4	10/10	0.18	10/20	22	0.13	1	55	
		EU02Z	1.0	15	-40 to +150	1.4	1.0	10	300	100	0.4	10/10	0.18	10/20	20	0.2	2	56	
		EU 2Z	1.0	15	-40 to +150	1.4	1.0	10	300	100	0.4	10/10	0.18	10/20	17	0.3	3	56	
		RU 2Z	1.0	20	-40 to +150	1.5	1.0	10	300	100	0.4	10/10	0.18	10/20	15	0.4	4	58	
		RU 30Z	1.5 (3.5)	80	-40 to +150	0.97	3.5	10	300	100	0.4	10/10	0.18	10/20	10	1.0	5	59	
		RU 4Z	2.0 (3.5)	70	-40 to +150	1.3	3.5	10	300	100	0.4	10/10	0.18	10/20	8	1.2	6	60	
		Center-tap	FMU-12S, R	5.0	30	-40 to +150	1.5	2.5	50	500	100	0.4	100/100	0.18	100/200	4.0	2.1	7	61
FMU-22S, R	10		40	-40 to +150	1.5	5.0	50	500	100	0.4	100/100	0.18	100/200	4.0	2.1	7	62		
FMU-32S, R	20		80	-40 to +150	1.5	10	50	500	100	0.4	100/100	0.18	100/200	2.0	5.5	8	62		

External Dimensions Flammability: UL94V-0 or Equivalent (Unit: mm)

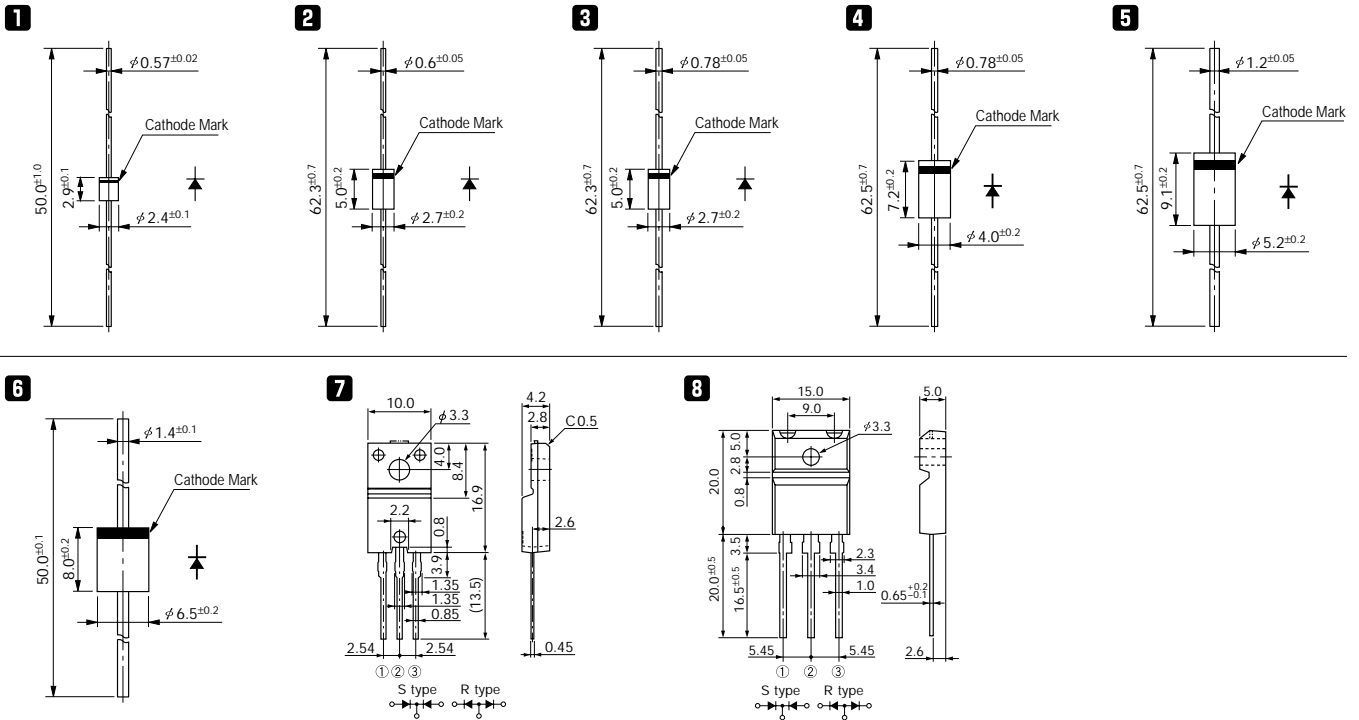

Fast-Recovery Rectifier Diodes 400V

$t_{rr} \textcircled{1}$: $I_F/I_R (=I_F)$ 90% Recovery Point
 (ex. $I_F/I_R = 100\text{mA}/100\text{mA}$ 90% Recovery Point)
 $t_{rr} \textcircled{2}$: $I_F/I_R (=2 I_F)$ 75% Recovery Point
 (ex. $I_F/I_R = 100\text{mA}/200\text{mA}$ 75% Recovery Point)

V_{RM} (V)	Package	Part Number	I_F (AV) (A) () is with Heatsink	I_{FSM} (A) 50Hz Half-cycle Sinewave Single Shot	T_j (°C)	T_{stg} (°C)	V_F (V) max	I_F (A)	I_R (μ A) $V_R = V_{RM}$ max	I_R (H) (μ A) $V_R = V_{RM}$ max	T_a (°C)	$t_{rr} \textcircled{1}$ (μ s)		$t_{rr} \textcircled{2}$ (μ s)		$R_{th(j-\ell)}$ $R_{th(j-c)}$ (°C/W)	Mass (g)	Fig. No.	Page where characteristic curve is shown
												I_F/I_{FP} (mA)	I_F/I_{FP} (mA)						
400	Axial	EU01	0.25	15	-40 to +150	2.5	0.25	10	150	100	100	0.4	10/10	0.18	10/20	20	0.2	2	55
		EU 1	0.25	15	-40 to +150	2.5	0.25	10	150	100	100	0.4	10/10	0.18	10/20	17	0.3	3	56
		RU 1	0.25	15	-40 to +150	2.5	0.25	10	200	100	100	0.4	10/10	0.18	10/20	15	0.4	4	58
		AU01	0.5	15	-40 to +150	1.7	0.5	10	150	100	100	0.4	10/10	0.18	10/20	22	0.13	1	55
		AS01	0.6	20	-40 to +150	1.5	0.6	10	50	100	100	1.5	10/10	0.6	10/20	22	0.13		
		EH 1	0.6	30	-40 to +150	1.35	0.6	10	200	150	100	4	10/10	1.3	10/20	17	0.3	3	56
		RF 1	0.6	15	-40 to +150	2.0	0.6	10	200	100	100	0.4	10/10	0.18	10/20	15	0.4	4	57
		RH 1	0.6	35	-40 to +150	1.3	0.6	5	70	150	100	4	10/10	1.3	10/20	15	0.4		
		ES 1	0.7	30	-40 to +150	2.5	0.8	10	200	100	100	1.5	10/10	0.6	10/20	20	0.2	2	56
		ES01	0.7	30	-40 to +150	2.5	0.8	10	200	100	100	1.5	10/10	0.6	10/20	20	0.2		
		AU02	0.8	25	-40 to +150	1.3	0.8	10	250	100	100	0.4	10/10	0.18	10/20	22	0.13	1	55
		EU02	1.0	15	-40 to +150	1.4	1.0	10	300	100	100	0.4	10/10	0.18	10/20	20	0.2	2	
		EU 2	1.0	15	-40 to +150	1.4	1.0	10	300	100	100	0.4	10/10	0.18	10/20	17	0.3	3	58
		RU 2M	1.1	20	-40 to +150	1.2	1.1	10	300	100	100	0.4	10/10	0.18	10/20	15	0.4	4	
		RU 3	1.5	20	-40 to +150	1.5	1.5	10	400	100	100	0.4	10/10	0.18	10/20	12	0.6	5	60
		RU 3M	1.5	50	-40 to +150	1.1	1.5	10	350	100	100	0.4	10/10	0.18	10/20	12	0.6		
		RU 30	2.0	200	-40 to +150	0.95	2.0	10	300	100	100	0.4	100/100	0.18	100/200	10	1.0	6	61
		RU 31	3.0	150	-40 to +150	1.2	3.0	50	500	100	100	0.4	100/100	0.18	100/200	10	1.0		
		RU 4	1.5 (3.0)	50	-40 to +150	1.5	3.0	10	300	100	100	0.4	10/10	0.18	10/20	8	1.2	7	62
		RU 4M	2.0 (3.5)	70	-40 to +150	1.3	3.5	10	300	100	100	0.4	100/100	0.18	100/200	8	1.2		
Center-tap	FMU-14S, R	5.0	30	-40 to +150	1.5	2.5	50	500	100	100	0.4	100/100	0.18	100/200	4.0	2.1	8	61	
	FMU-24S, R	10	40	-40 to +150	1.5	5.0	50	500	100	100	0.4	100/100	0.18	100/200	4.0	2.1			
	FMU-34S, R	20	80	-40 to +150	1.5	10	50	500	100	100	0.4	100/100	0.18	100/200	2.0	5.5	9	62	

External Dimensions Flammability: UL94V-0 or Equivalent (Unit: mm)

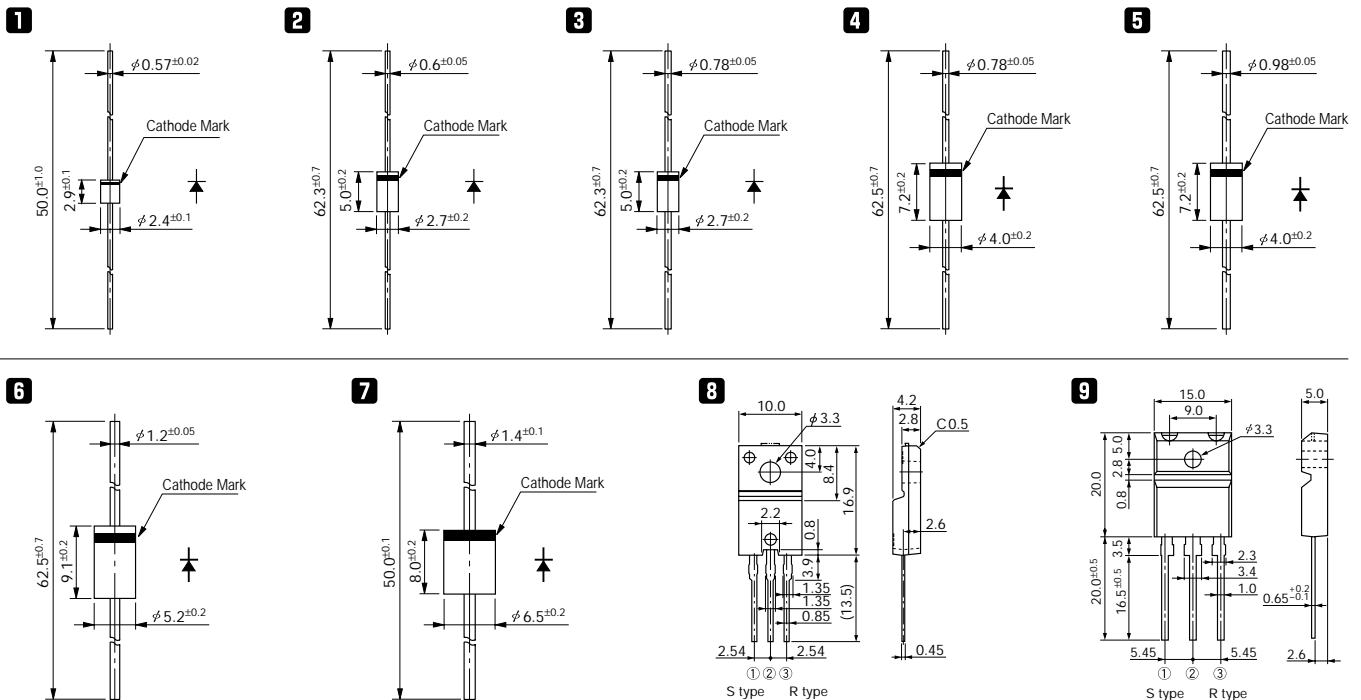

Fast-Recovery Rectifier Diodes 600V

trr ①: I_F/I_R(=I_F) 90% Recovery Point
 (ex. I_F/I_R = 100mA/100mA 90% Recovery Point)
 trr ②: I_F/I_R(=2 I_F) 75% Recovery Point
 (ex. I_F/I_R = 100mA/200mA 75% Recovery Point)

V _{RM} (V)	Package	Part Number	I _F (AV) (A) () is with Heatsink	I _{FSM} (A) 50Hz Half-cycle Sine-wave Single Shot	T _j (°C)	T _{stg} (°C)	V _F (V) max	I _R (μA)		Ta (°C)	trr ① (μs)		trr ② (μs)		R _{th} (j-ℓ) R _{th} (j-c) (°C/W)	Mass (g)	Fig. No.	Page where characteristic curve is shown
								I _F (A)	V _R =V _{RM} max		V _R =V _{RM} max	I _F /I _{FP} (mA)	I _F /I _{FP} (mA)					
600	Axial	EU01A	0.25	15	-40 to +150	2.5	0.25	10	150	100	0.4	10/10	0.18	10/20	20	0.2	2	55
		EU 1A	0.25	15	-40 to +150	2.5	0.25	10	150	100	0.4	10/10	0.18	10/20	17	0.3	1	56
		RU 1A	0.25	15	-40 to +150	2.5	0.25	10	200	100	0.4	10/10	0.18	10/20	15	0.4	4	58
		AU01A	0.5	15	-40 to +150	1.7	0.5	10	150	100	0.4	10/10	0.18	10/20	22	0.13	1	55
		AS01A	0.6	20	-40 to +150	1.5	0.6	10	50	100	1.5	10/10	0.6	10/20	22	0.13	1	55
		EH 1A	0.6	30	-40 to +150	1.35	0.6	10	200	150	4	10/10	1.3	10/20	17	0.3	3	56
		RF 1A	0.6	15	-40 to +150	2.0	0.6	10	200	100	0.4	10/10	0.18	10/20	15	0.4	4	57
		RH 1A	0.6	35	-40 to +150	1.3	0.6	5	70	150	4	10/10	1.3	10/20	15	0.4	4	57
		ES 1A	0.7	30	-40 to +150	2.5	0.8	10	200	100	1.5	10/10	0.6	10/20	20	0.2	2	56
		ES01A	0.7	30	-40 to +150	2.5	0.8	10	200	100	1.5	10/10	0.6	10/20	20	0.2	2	55
		RS 1A	0.7	30	-40 to +150	2.5	0.8	10	200	100	1.5	10/10	0.6	10/20	20	0.4	4	57
		AU02A	0.8	25	-40 to +150	1.3	0.8	10	250	100	0.4	10/10	0.18	10/20	22	0.13	1	55
		EU02A	1.0	15	-40 to +150	1.4	1.0	10	300	100	0.4	10/10	0.18	10/20	20	0.2	2	56
		EU 2A	1.0	15	-40 to +150	1.4	1.0	10	300	100	0.4	10/10	0.18	10/20	17	0.3	3	56
		RU 2	1.0	20	-40 to +150	1.5	1.0	10	300	100	0.4	10/10	0.18	10/20	15	0.4	4	58
		RU 2AM	1.1	20	-40 to +150	1.2	1.1	10	300	100	0.4	10/10	0.18	10/20	15	0.4	4	58
		RU 20A	1.5	50	-40 to +150	1.1	1.5	10	350	100	0.4	10/10	0.18	10/20	15	0.4	4	58
		RU 3A	1.5	20	-40 to +150	1.5	1.5	10	400	100	0.4	10/10	0.18	10/20	12	0.6	5	59
		RU 3AM	1.5	50	-40 to +150	1.1	1.5	10	350	100	0.4	10/10	0.18	10/20	12	0.6	5	59
		RU 30A	2.0	200	-40 to +150	0.95	2.0	10	300	100	0.4	100/100	0.18	100/200	10	1.0	6	59
		RU 31A	3.0	150	-40 to +150	1.2	3.0	50	500	100	0.4	100/100	0.18	100/200	10	1.0	6	59
		RU 4A	1.5 (3.0)	50	-40 to +150	1.5	3.0	10	300	100	0.4	10/10	0.18	10/20	8	1.2	7	60
		RU 4AM	2.0 (3.5)	70	-40 to +150	1.3	3.5	10	300	100	0.4	100/100	0.18	100/200	8	1.2	7	60
		Frame-2Pin	FMUP-1056	5.0	30	-40 to +150	1.25	5.0	50	500	100	0.4	100/100	0.18	100/200	4.0	2.1	8
FMUP-1106	10		40	-40 to +150	1.35	10	50	500	100	0.4	100/100	0.18	100/200	4.0	2.1	8	61	
Center-tap	FMU-16S, R	5.0	30	-40 to +150	1.5	2.5	50	500	100	0.4	100/100	0.18	100/200	4.0	2.1	9	61	
	FMUP-2056*	5.0	30	-40 to +150	1.5	2.5	50	500	100 (T _j)	0.4	100/100	0.18	100/200	4.0	2.1	9	61	
	FMU-26S, R	10	40	-40 to +150	1.5	5.0	50	500	100	0.4	100/100	0.18	100/200	4.0	2.1	10	62	
	FMU-36S, R	20	80	-40 to +150	1.5	10	50	500	100	0.4	100/100	0.18	100/200	2.0	5.5	10	62	

* : Under development

External Dimensions Flammability: UL94V-0 or Equivalent (Unit: mm)

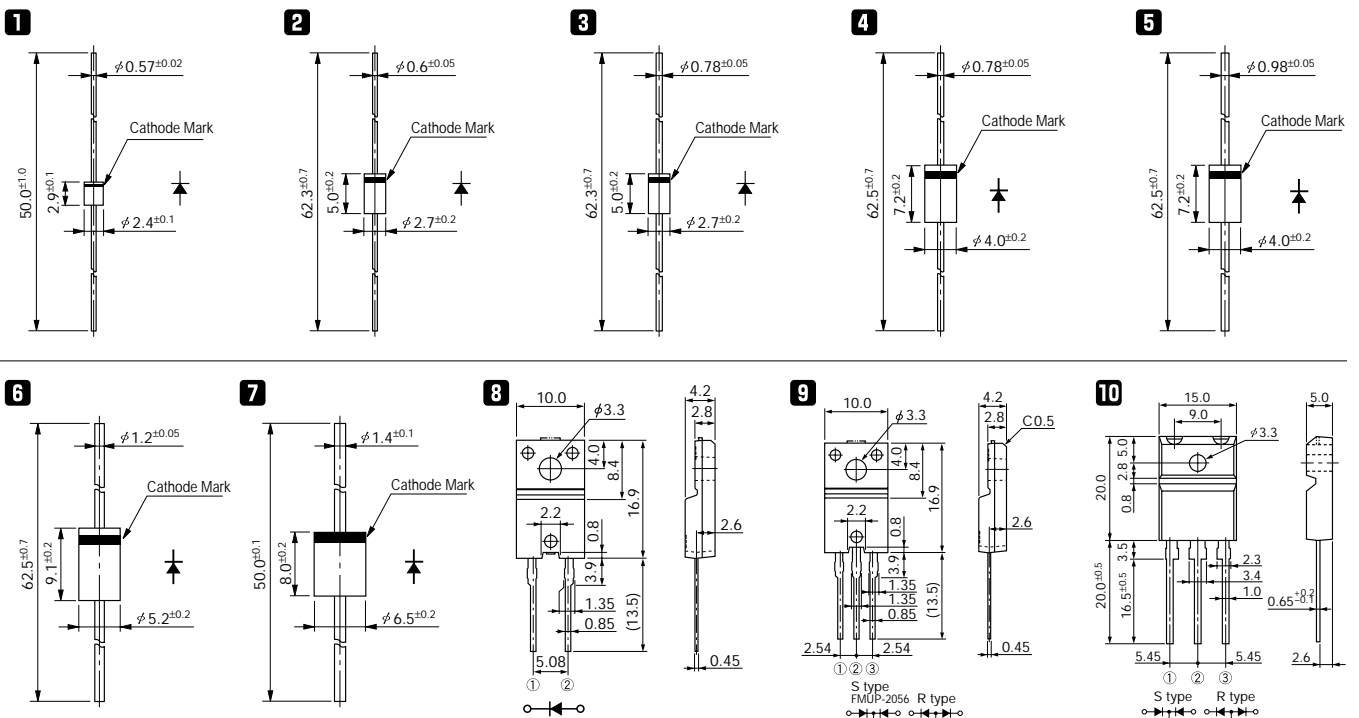

Fast-Recovery Rectifier Diodes 800V

$t_{rr} \textcircled{1}$: $I_F/I_R (=I_F)$ 90% Recovery Point
 (ex. $I_F/I_R = 100\text{mA}/100\text{mA}$ 90% Recovery Point)
 $t_{rr} \textcircled{2}$: $I_F/I_R (=2 I_F)$ 75% Recovery Point
 (ex. $I_F/I_R = 100\text{mA}/200\text{mA}$ 75% Recovery Point)

V_{RM} (V)	Package	Part Number	I_F (AV) (A) () is with Heatsink	I_{FSM} (A)	T_j (°C)	T_{stg} (°C)	V_F (V) max	I_F (A)	I_R (μ A)	I_R (H) (μ A)	T_a (°C)	$t_{rr} \textcircled{1}$ (μ s)		$t_{rr} \textcircled{2}$ (μ s)		$R_{th} (j-l)$ (°C/W)	Mass (g)	Fig. No.	Page where characteristic curve is shown
				50Hz Half-cycle Sinewave Single Shot					$V_R = V_{RM}$ max	$V_R = V_{RM}$ max		I_F/I_{FP} (mA)	I_F/I_{FP} (mA)						
800	Axial	RU 1B	0.25	15	-40 to +150	2.5	0.25	10	200	100	0.4	10/10	0.18	10/20	15	0.4	1	58	
		RF 1B	0.6	15	-40 to +150	2.0	0.6	10	200	100	0.4	10/10	0.18	10/20	15	0.4		57	
		RH 1B	0.6	35	-40 to +150	1.3	0.6	5	70	150	4	10/10	1.3	10/20	15	0.4		58	
		RS 1B	0.7	30	-40 to +150	2.5	0.8	10	200	100	1.5	10/10	0.6	10/20	20	0.4	2	59	
		RU 2B	1.0	20	-40 to +150	1.5	1.0	10	300	100	0.4	10/10	0.18	10/20	15	0.4		60	
		RU 3B	1.1	20	-40 to +150	1.5	1.0	10	400	100	0.4	10/10	0.18	10/20	12	0.6		59	
		RU 4B	1.5 (3.0)	50	-40 to +150	1.6	3.0	10	500	100	0.4	10/10	0.18	10/20	8	1.2		60	

External Dimensions Flammability: UL94V-0 or Equivalent (Unit: mm)

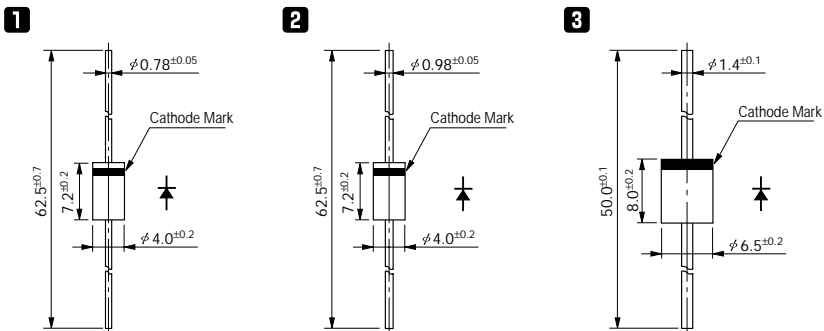

Fast-Recovery Rectifier Diodes 1000V

$t_{rr} \textcircled{1}$: $I_F/I_R (=I_F)$ 90% Recovery Point
 (ex. $I_F/I_R = 100\text{mA}/100\text{mA}$ 90% Recovery Point)
 $t_{rr} \textcircled{2}$: $I_F/I_R (=2 I_F)$ 75% Recovery Point
 (ex. $I_F/I_R = 100\text{mA}/200\text{mA}$ 75% Recovery Point)

V_{RM} (V)	Package	Part Number	I_F (AV) (A) () is with Heatsink	I_{FSM} (A)	T_j (°C)	T_{stg} (°C)	V_F (V) max	I_F (A)	I_R (μ A)		T_a (°C)	$t_{rr} \textcircled{1}$ (μ s)		$t_{rr} \textcircled{2}$ (μ s)		$R_{th(j-l)}$ (°C/W)	Mass (g)	Fig. No.	Page, where characteristic curve is shown
				50Hz Half-cycle Sinewave Single Shot					$V_R = V_{RM}$ max	$V_R = V_{RM}$ max		I_F/I_{FP} (mA)	I_F/I_{FP} (mA)						
1000	Axial	RU 1C	0.2	15	-40 to +150	3.0	0.25	10	200	100	0.4	10/10	0.18	10/20	15	0.4		58	
		RH 1C	0.6	35	-40 to +150	1.3	0.6	5	70	150	4	10/10	1.3	10/20	15	0.4	1	57	
		RU 2C	0.8	20	-40 to +150	1.5	1.0	10	300	100	0.4	10/10	0.18	10/20	15	0.4		58	
		RU 3C	1.5	20	-40 to +150	2.5	1.5	10	400	100	0.4	10/10	0.18	10/20	12	0.6	2	59	
		RU 4C	1.5 (2.5)	50	-40 to +150	1.6	3.0	50	500	100	0.4	100/100	0.18	100/200	8	1.2	3	60	

External Dimensions Flammability: UL94V-0 or Equivalent (Unit: mm)

1

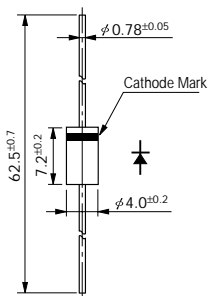

2

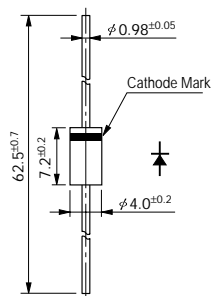

3

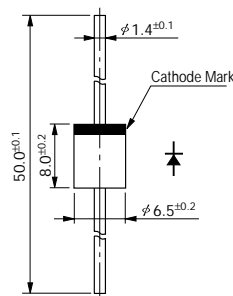

Fast-Recovery Rectifier Diodes 1300V and over

$t_{rr} \textcircled{1}$: $I_F/I_R (=I_F)$ 90% Recovery Point
 (ex. $I_F/I_R = 100\text{mA}/100\text{mA}$ 90% Recovery Point)
 $t_{rr} \textcircled{2}$: $I_F/I_R (=2 I_F)$ 75% Recovery Point
 (ex. $I_F/I_R = 100\text{mA}/200\text{mA}$ 75% Recovery Point)

V_{RM} (V)	Package	Part Number	I_F (AV) (A) () is with Heatsink	I_{FSM} (A) 50Hz Half-cycle Sine Wave Single Shot	T_j ($^{\circ}\text{C}$)	T_{stg} ($^{\circ}\text{C}$)	V_F (V) max	I_F (A)	I_R (μA) $V_R = V_{RM}$ max	I_R (H) (μA) $V_R = V_{RM}$ max	T_a ($^{\circ}\text{C}$)	$t_{rr} \textcircled{1}$ (μs)		$t_{rr} \textcircled{2}$ (μs)		$R_{th(j-l)}$ ($^{\circ}\text{C}/\text{W}$)	Mass (g)	Fig. No.	Page where characteristic curve is shown
												I_F/I_{FP} (mA)	I_F/I_{FP} (mA)						
1300	Axial	RH 2D	1.0	60	-40 to +150	1.0	1.0	10	500	100	100	4	10/10	1.3	100/200	12	0.6	4	96
		RU 4D	1.2 (1.5)	50	-40 to +150	1.8	1.5	50	500	100	100	0.4	500/500	0.18	500/1000	8	1.2	6	97
		RU 4DS	1.5 (2.5)	50	-40 to +150	1.8	3.0	50	500	100	100	0.4	500/500	0.18	500/1000	8	1.2	6	97
1500	Axial	ES01F	0.5	20	-40 to +150	2.0	0.5	10	200	100	100	1.5	10/10	0.6	10/20	20	0.2	1	55
		ES 1F	0.5	20	-40 to +150	2.0	0.5	10	200	100	100	1.5	10/10	0.6	10/20	17	0.3	2	56
		RH 10F	0.8	60	-40 to +150	1.0	1.0	10	500	100	100	4	10/10	1.3	100/200	15	0.4	3	96
		RH 2F	1.0	60	-40 to +150	1.0	1.0	10	500	100	100	4	10/10	1.3	100/200	12	0.6	4	
		RS 3FS	2.0	50	-40 to +150	1.1	3.0	50	500	100	100	2	100/100	0.8	100/200	10	1.0	5	
		RP 3F	2.0	50	-40 to +150	1.7	2.0	50	500	100	100	0.7	500/500	0.3	500/1000	10	1.0	5	
		RH 3F	2.5	50	-40 to +150	1.3	2.5	50	500	100	100	4	100/100	1.3	100/200	10	1.0	5	
		RH 4F	2.5	50	-40 to +150	1.5	2.5	10	350	100	100	4	100/100	1.3	100/200	8	1.2	6	97
	RS 4FS	1.5 (2.5)	50	-40 to +150	1.5	3.0	50	500	100	100	1	100/100	0.4	100/200	8	1.2	6		
	Frame-2Pin	FMQ-G1FS	5.0	50	-40 to +150	2.0	5.0	50	500	150 (T_j)	0.7	500/500	0.3	500/1000	4.0	2.1	7	98	
		FMQ-G2FS	10	50	-40 to +150	2.8	10	50	500	150 (T_j)	0.5	500/500	0.2	500/1000	4.0	2.1	7	99	
		FMU-G2FS	10	50	-40 to +150	1.6	10	50	6000	150 (T_j)	0.6	500/500	0.25	500/1000	4.0	2.1	7	98	
FMQ-G2FLS		10	50	-40 to +150	1.8	10	50	500	150 (T_j)	1.2	500/500	0.4	500/1000	4.0	2.1	7	98		
FMQ-G2FMS		10	50	-40 to +150	2.4	10	50	500	150	0.5	500/500	0.25	500/1000	4.0	2.1	8	99		
FMQ-G5FMS		10	50	-40 to +150	2.4	10	50	500	100	0.5	500/500	0.2	500/1000	2	6.5	8	99		
1600	Axial	RH 3G	2.5	50	-40 to +150	1.3	2.5	50	500	100	100	4	100/100	1.3	100/200	10	1.0	5	96
1700	Frame-2Pin	FMQ-G5GS	10	50	-40 to +150	2.7	10	100	500	100	100	0.5	500/500	0.2	500/1000	2	6.5	8	99
1800	Frame-2Pin	FMP-G5HS	8.0	50	-40 to +150	2.0	8	25	250	100	100	1.0	500/500	0.4	500/1000	2	6.5	8	99
		FMR-G5HS	10	50	-40 to +150	1.6	10	20	200	100	100	1.8	500/500	0.7	500/1000	2	6.5	8	99
2000	Axial	RC 2	0.2	20	-40 to +150	2.0	0.2	10	300	100	100	4.0	10/10	1.3	10/20	15	0.4	3	57

External Dimensions Flammability: UL94V-0 or Equivalent (Unit: mm)

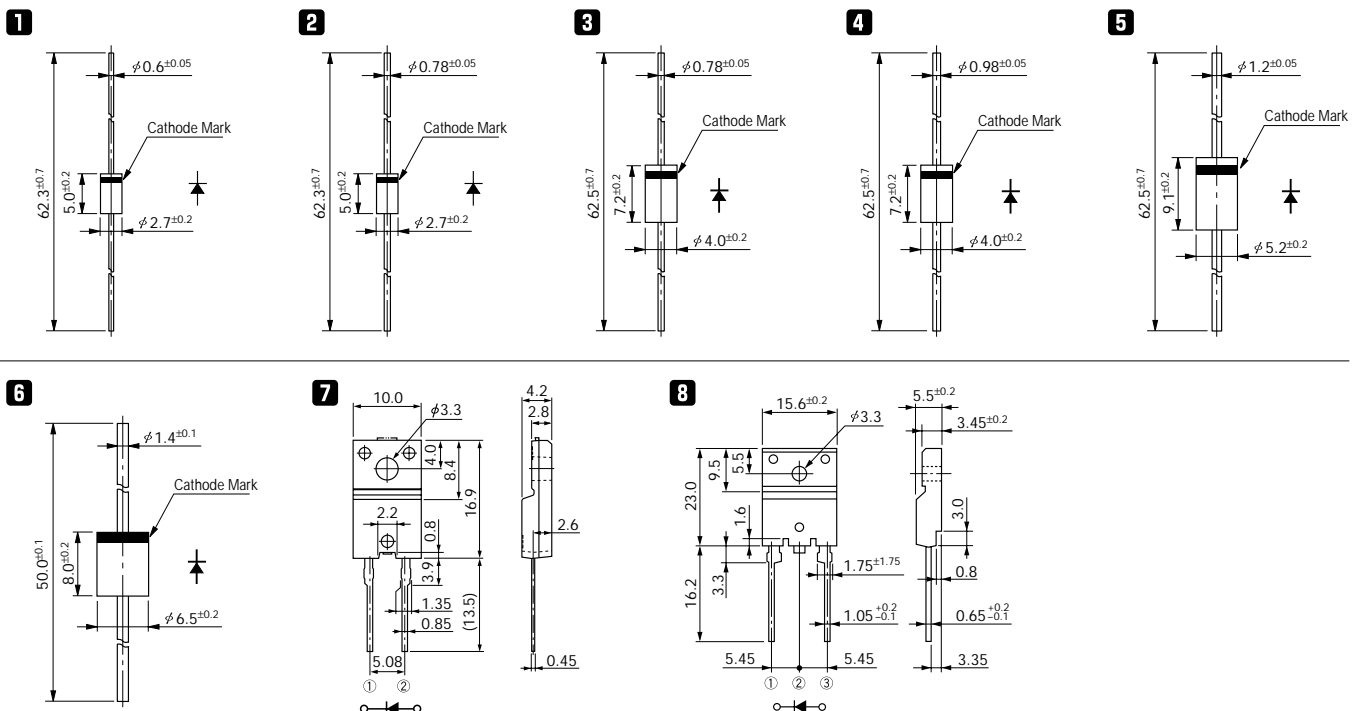

Ultra-Fast-Recovery Rectifier Diodes 70V

$t_{rr} \textcircled{1}$: $I_F/I_R (=I_F)$ 90% Recovery Point
 (ex. $I_F/I_R = 100\text{mA}/100\text{mA}$ 90% Recovery Point)
 $t_{rr} \textcircled{2}$: $I_F/I_R (=2 I_F)$ 75% Recovery Point
 (ex. $I_F/I_R = 100\text{mA}/200\text{mA}$ 75% Recovery Point)

V_{RM} (V)	Package	Part Number	I_F (AV) (A)	I_{FSM} (A)	T_j (°C)	T_{stg} (°C)	V_F (V) max	I_F (A)	I_R (μ A)	I_R (H) (mA)	T_a (°C)	$t_{rr} \textcircled{1}$ (ns)		$t_{rr} \textcircled{2}$ (ns)		$R_{th(j-l)}$ (°C/W)	Mass (g)	Fig. No.	Page, where characteristic curve is shown
				50Hz Half-cycle Sinewave Single Shot					$V_R = V_{RM}$ max	$V_R = V_{RM}$ max		I_F/I_{FP} (mA)	I_F/I_{FP} (mA)						
70	Axial	AG01Y	1.0	25	-40 to +150	1.2	1.0	100	0.5	100	100	100/100	50	100/200	22	0.13	1	64	
		EG01Y	1.0	30	-40 to +150	1.2	1.0	100	0.5	100	100	100/100	50	100/200	20	0.2	2		
		EG 1Y	1.1	30	-40 to +150	1.2	1.1	100	0.5	100	100	100/100	50	100/200	17	0.3	3		
		RG 10Y	1.5	50	-40 to +150	1.1	1.5	500	2.5	100	100	100/100	50	100/200	15	0.4	4		
		RG 2Y	1.5	50	-40 to +150	1.1	1.5	500	2.5	100	100	100/100	50	100/200	12	0.6	5		
		RG 4Y	2.0 (3.5)	100	-40 to +150	1.3	3.5	1000	5	100	100	100/100	50	100/200	8	1.2	6		

External Dimensions Flammability: UL94V-0 or Equivalent (Unit: mm)

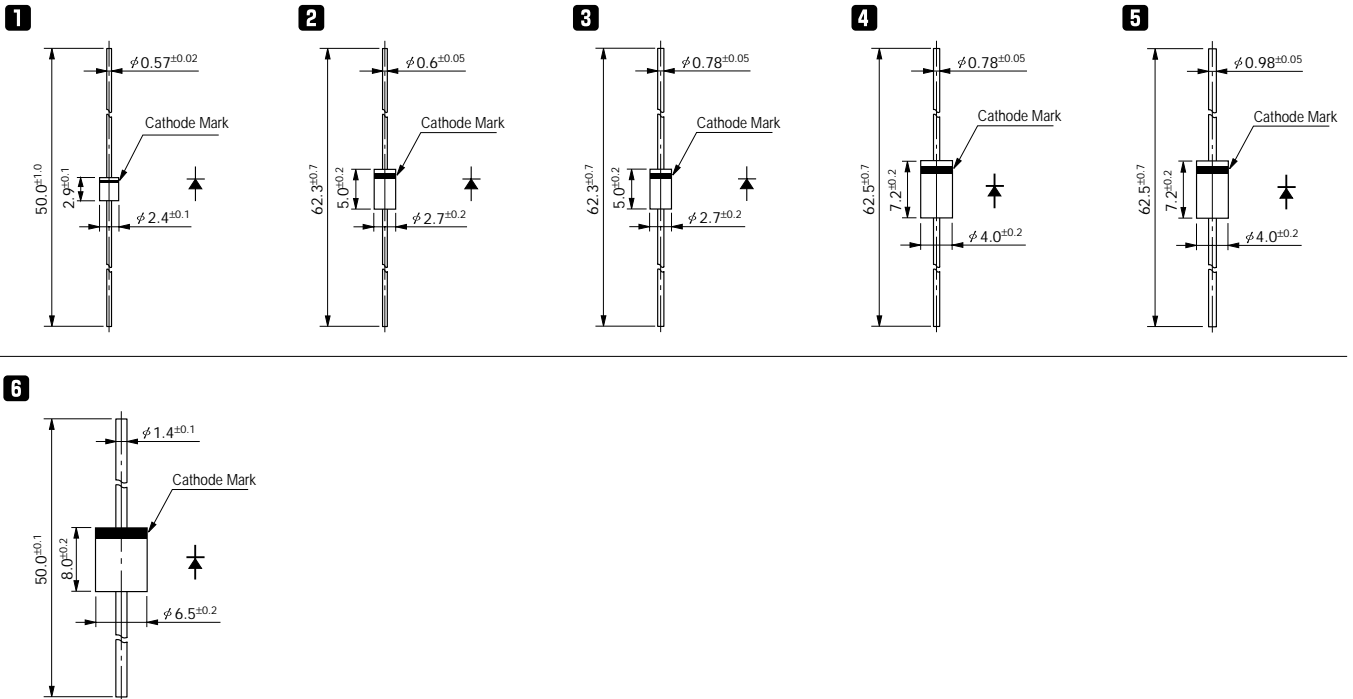

Ultra-Fast-Recovery Rectifier Diodes 200V

$t_{rr} \textcircled{1}$: $I_F/I_R (=I_F)$ 90% Recovery Point
 (ex. $I_F/I_R = 100\text{mA}/100\text{mA}$ 90% Recovery Point)
 $t_{rr} \textcircled{2}$: $I_F/I_R (=2 I_F)$ 75% Recovery Point
 (ex. $I_F/I_R = 100\text{mA}/200\text{mA}$ 75% Recovery Point)

V _{RM} (V)	Package	Part Number	I _F (AV) (A)	I _{FSM} (A)	T _j (°C)	T _{stg} (°C)	V _F (V) max	I _F (A)	I _R (μA)	I _R (H) (mA)	T _a (°C)	t _{rr} ① (ns)		t _{rr} ② (ns)		R _{th(j-l)} R _{th(j-c)} (°C/W)	Mass (g)	Fig. No.	Page where characteristic curve is shown
				50Hz Half-cycle Sinewave Single Shot					V _R =V _{RM} max	V _R =V _{RM} max		I _F /I _{FP} (mA)	I _F /I _{FP} (mA)						
200	Surface Mount	SFPL-52	0.9	25	-40 to +150	0.98	1.0	10	1	150 (Tj)	50	100/100	35	100/200	20	0.072	1	63	
		SFPL-62	1.0	25	-40 to +150	0.98	1.0	10	1	150 (Tj)	50	100/100	35	100/200	20	0.072			
		SFPX-62	1.5	30	-40 to +150	0.98	1.5	10	2	150 (Tj)	30	100/100	25	100/200	20	0.072			
		SPX-G32S	3.0	50	-40 to +150	0.98	3.0	50	10	100	30	100/100	25	100/200	5.0	0.41	2	64	
		MPL-102S	10.0	65	-40 to +150	0.98	5.0	100	0.2	150	40	100/100	30	100/200	2.5	1.4	15	80	
	Surface Mount Center-tap	SPX-62S	6.0	80	-40 to +150	0.98	3.0	50	10	100	30	100/100	25	100/200	5.0	0.41	2	64	
		MP2-202S	20.0	110	-40 to +150	0.98	10.0	200	0.4	150	50	100/100	35	100/200	2.5	1.4	15	80	
	Axial	AG01Z	0.7	15	-40 to +150	1.8	0.7	100	0.5	100	100	100/100	50	100/200	22	0.13	3	64	
		EG01Z	0.7	15	-40 to +150	1.9	0.7	50	0.3	100	100	100/100	50	100/200	20	0.2	4		
		EG 1Z	0.8	15	-40 to +150	1.7	0.8	50	0.3	100	100	100/100	50	100/200	17	0.3	5	65	
		AL01Z	1.0	25	-40 to +150	0.98	1.0	100	0.5	100	50	100/100	35	100/200	22	0.13	3	64	
		EN01Z	1.0	50	-40 to +150	0.92	1.0	10	2	150 (Tj)	100	100/100	50	100/200	20	0.2	4	65	
		RG 10Z	1.2	50	-40 to +150	1.5	1.2	500	2.5	100	100	100/100	50	100/200	15	0.4	6	66	
		RG 2Z	1.2	50	-40 to +150	1.5	1.5	500	2.5	100	100	100/100	50	100/200	12	0.6	7	68	
		EL02Z	1.5	25	-40 to +150	0.98	1.5	50	0.1	100	40	100/100	30	100/200	20	0.2	4	65	
		EL 1Z	1.5	20	-40 to +150	0.98	1.5	100	0.5	100	100	100/100	50	100/200	17	0.3	5	66	
		RN 1Z	1.5	60	-40 to +150	0.92	1.5	20	3	150 (Tj)	100	100/100	50	100/200	15	0.4	6	67	
		RX 10Z *	2.0	30	-40 to +150	0.98	2.0	50	3	150 (Tj)	30	100/100	25	100/200	15	0.4		80	
		RL 10Z	2.0	30	-40 to +150	0.98	2.0	50	0.1	100	50	100/100	35	100/200	15	0.4	7	67	
		RL 2Z	2.0	30	-40 to +150	0.98	2.0	100	0.5	100	50	100/100	35	100/200	12	0.6		68	
		RN 2Z	2.0	70	-40 to +150	0.92	2.0	50	4	150 (Tj)	100	100/100	50	100/200	12	0.6	8	69	
		RN 3Z	3.0	80	-40 to +150	0.92	3.0	50	6	150 (Tj)	100	100/100	50	100/200	10	1.0		70	
		RX 3Z	3.0	80	-40 to +150	0.98	3.0	50	10	100	30	100/100	25	100/200	10	1.0	9	71	
		RG 4Z	1.0 (3.0)	80	-40 to +150	1.7	3.0	1000	5	100	100	100/100	35	100/200	8	1.2			
	RL 3Z	3.5	80	-40 to +150	0.95	3.5	50	0.2	100	50	100/100	35	100/200	10	1.0	8	69		
	RL 4Z	3.5	80	-40 to +150	0.95	3.5	150	0.5	100	50	100/100	50	100/200	8	1.2				
	RN 4Z	3.5	120	-40 to +150	0.92	3.5	50	6	150 (Tj)	100	100/100	50	100/200	8	1.2	9	71		
	Frame-2Pin	FML-G12S	5.0	65	-40 to +150	0.98	5.0	250	1	100	40	100/100	30	100/200	4.0			2.1	10
		FMN-G12S	5.0	100	-40 to +150	0.92	5.0	100	10	100	100	100/100	50	100/200	4.0	2.1			
		FMP-G12S	5.0	65	-40 to +150	1.15	5.0	50	0.5	100	150	100/100	70	100/200	4.0	2.1			
FMX-G12S		5.0	65	-40 to +150	0.98	5.0	100	20	100	30	100/100	25	100/200	4.0	2.1				
FML-G22S		10.0	150	-40 to +150	0.98	10.0	500	2	100	40	500/500	30	500/1000	4.0	2.1				
FMX-G22S		10.0	150	-40 to +150	0.98	10.0	200	50	100	30	500/500	25	500/1000	4.0	2.1				
Center-tap	FMG-12S, R	5.0	35	-40 to +150	1.8	2.5	500	1.5	100	100	100/100	50	100/200	4.0	2.1	11	74		
	FML-12S	5.0	35	-40 to +150	0.98	2.5	150	0.5	100	40	100/100	30	100/200	4.0	2.1		75		
	FMX-12S	5.0	35	-40 to +150	0.98	2.5	50	10	100	30	100/100	25	100/200	4.0	2.1		77		
	FMG-22S, R	10.0	65	-40 to +150	1.8	5.0	500	1.5	100	100	100/100	50	100/200	4.0	2.1	11	75		
	FML-22S	10.0	65	-40 to +150	0.98	5.0	250	1	100	40	100/100	30	100/200	4.0	2.1		76		
	FMX-22S	10.0	65	-40 to +150	0.98	5.0	100	20	100	30	100/100	25	100/200	4.0	2.1		11	77	
	FMX-22SL	15.0	100	-40 to +150	0.98	7.5	150	30	100	30	500/500	25	500/1000	4.0	2.1				
	FMG-32S, R	20.0	150	-40 to +150	1.8	10.0	1000	5	100	100	100/100	50	100/200	2.0	5.5	12		78	
	FML-32S	20.0	150	-40 to +150	0.98	10.0	600	2	100	40	100/100	30	100/200	2.0	5.5				
FMX-32S	20.0	150	-40 to +150	0.98	10.0	200	50	100	30	500/500	25	500/1000	2.0	5.5					
Bridge	RBV-402L	4.0	80	-40 to +150	0.98	2.0	50	0.1	100	40	100/100	30	100/200	5.0	4.05	13	79		
	RBV-602L	6.0	100	-40 to +150	1.0	3.0	250	1	100	50	100/100	35	100/200	3.0	6.45	13			

* : Under development

Ultra-Fast-Recovery Rectifier Diodes 200V

External Dimensions Flammability: UL94V-0 or Equivalent (Unit: mm)

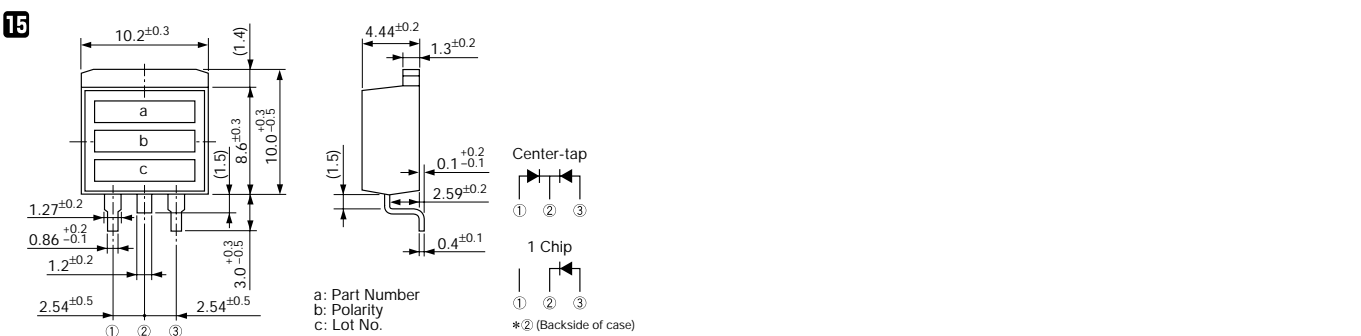
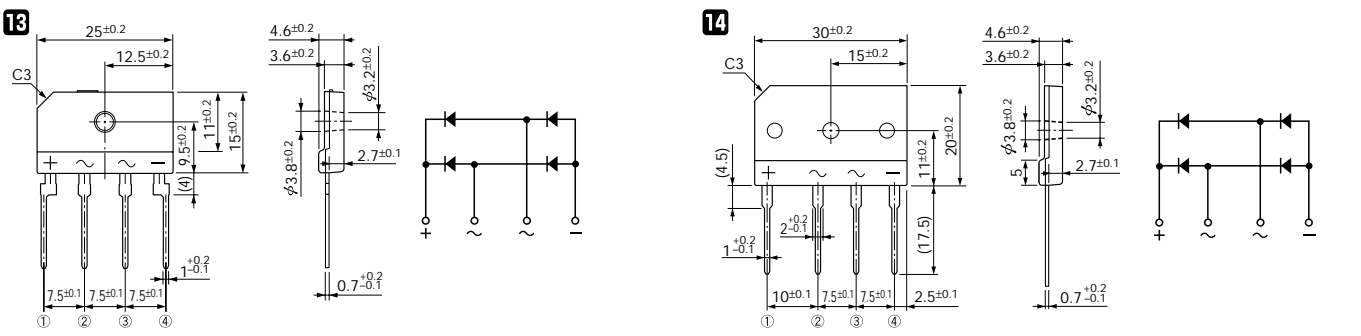
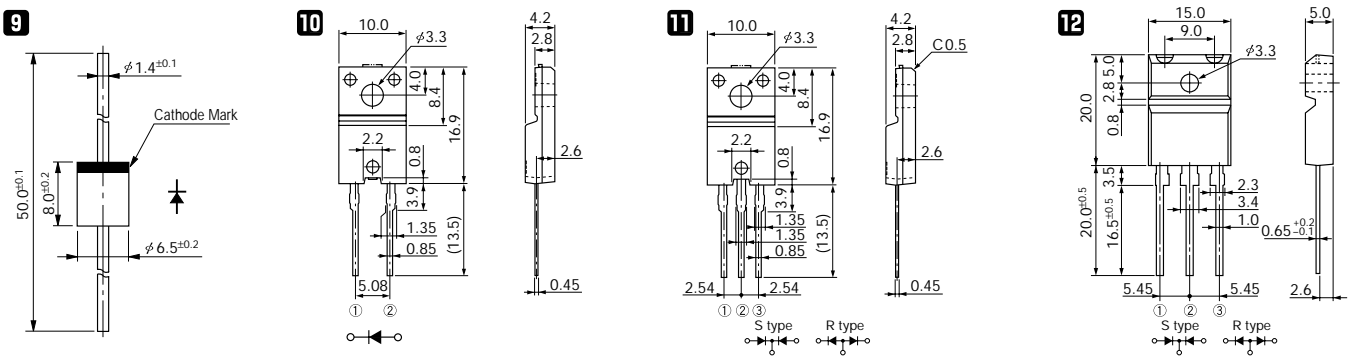
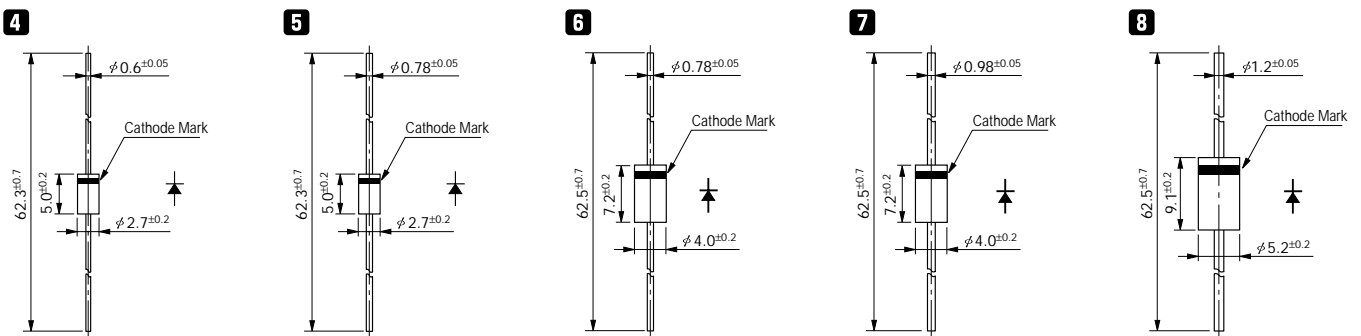
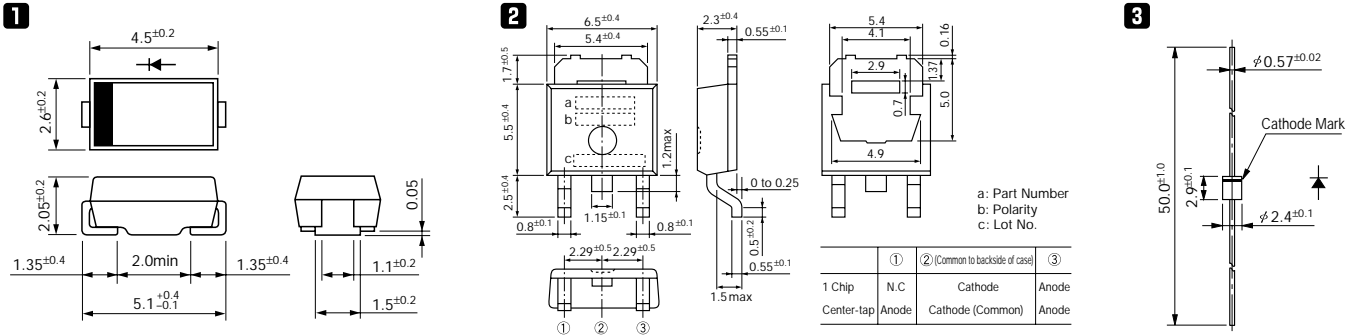

Ultra-Fast-Recovery Rectifier Diodes 300V

$t_{rr} \textcircled{1}$: $I_F/I_R (=I_F)$ 90% Recovery Point
 (ex. $I_F/I_R = 100\text{mA}/100\text{mA}$ 90% Recovery Point)
 $t_{rr} \textcircled{2}$: $I_F/I_R (=2I_F)$ 75% Recovery Point
 (ex. $I_F/I_R = 100\text{mA}/200\text{mA}$ 75% Recovery Point)

V _{RM} (V)	Package	Part Number	I _F (AV) (A)	I _{FSM} (A)	T _j (°C)	T _{stg} (°C)	V _F (V) max	I _F (A)	I _R (μA)	I _R (H) (mA)	T _a (°C)	t _{rr} (ns)		R _{th(j-ℓ)} R _{th(j-c)} (°C/W)	Mass (g)	Fig. No.	Page where characteristic curve is shown	
				50Hz Half-cycle Sinewave Single Shot					V _R =V _{RM} max	V _R =V _{RM} max		I _F /I _{FP} (mA)	I _F /I _{FP} (mA)					
300	Surface Mount	SFPX-63	2.0	20	-40 to +150	1.3	2	50	3	150	30	100/100	25	100/200	0.07	1	—	
	Surface Mount Center-tap	MPX-2103	10.0	65	-40 to +150	1.3	5.0	50	15	150(T _j)	30	100/100	25	100/200	2.5	1.04	5	81
	Frame-2Pin	FML-G13S	5.0	70	-40 to +150	1.3	5.0	100	0.2	100	50	100/100	35	100/200	4.0	2.1	2	72
	Center-tap	FMG-13S, R	5.0	35	-40 to +150	1.8	2.5	500	1.5	100	100	100/100	50	100/200	4.0	2.1	3	74
		FML-13S	5.0	40	-40 to +150	1.3	2.5	50	0.1	100	50	100/100	35	100/200	4.0	2.1		76
		FMG-23S, R	10.0	65	-40 to +150	1.8	5.0	500	1.5	100	100	100/100	50	100/200	4.0	2.1		75
		FML-23S	10.0	70	-40 to +150	1.3	5.0	100	0.5	100	50	100/100	35	100/200	4.0	2.1		76
		FMX-23S	10.0	65	-40 to +150	1.3	5.0	50	15	150	30	100/100	25	100/200	4.0	2.1		—
		FMX-2203	20.0	100	-40 to +150	1.3	10.0	100	30	150	30	500/500	25	500/1000	4.0	2.1		81
	Center-tap	FMG-33S, R	20.0	150	-40 to +150	1.8	10.0	1000	5	100	100	100/100	50	100/200	2.0	5.5	4	77
FML-33S		20.0	100	-40 to +150	1.3	10.0	200	1	100	50	500/500	35	500/1000	2.0	5.5	78		
FMX-33S		20.0	100	-40 to +150	1.3	10.0	100	30	150	30	500/500	25	500/1000	2.0	5.5	—		

External Dimensions Flammability: UL94V-0 or Equivalent (Unit: mm)

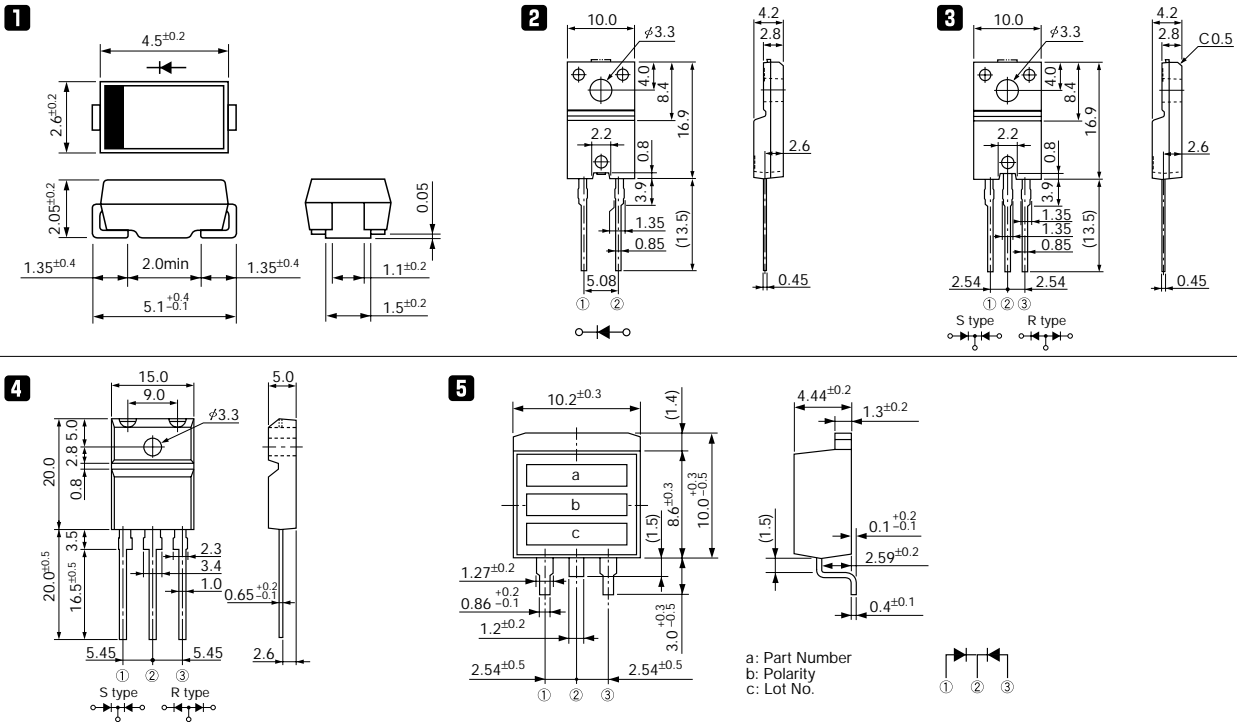

Ultra-Fast-Recovery Rectifier Diodes 400V

trr ①: I_F/I_R (=I_F) 90% Recovery Point
 (ex. I_F/I_R = 100mA/100mA 90% Recovery Point)
 trr ②: I_F/I_R (=2 I_F) 75% Recovery Point
 (ex. I_F/I_R = 100mA/200mA 75% Recovery Point)

V _{RM} (V)	Package	Part Number	I _F (AV) (A)	I _{FSM} (A)	T _j (°C)	T _{stg} (°C)	V _F (V) max	I _F (A)	I _R (μA)	I _R (H) (mA)	T _a (°C)	trr ① (ns)		trr ② (ns)		R _{th} (j-ℓ) R _{th} (j-c) (°C/W)	Mass (g)	Fig. No.	Page where characteristic curve is shown
				50Hz Half-cycle Sine-wave Single-Shot					V _R = V _{RM} max	V _R = V _{RM} max		I _F /I _{FP} (mA)	I _F /I _{FP} (mA)						
400	Surface Mount Center-tap	SFPL-64	1.0	25	-40 to +150	1.3	1.0	10	0.05	150	50	100/100	30	100/200	20	0.07	11	81	
		AG01	0.7	15	-40 to +150	1.8	0.7	100	0.5	100	100	100/100	50	100/200	22	0.13	1		64
		EG01	0.7	15	-40 to +150	2.0	0.7	50	0.3	100	100	100/100	50	100/200	20	0.2	2		
		EG 1	0.8	15	-40 to +150	1.8	0.8	50	0.3	100	100	100/100	50	100/200	17	0.3	3		
		AL01*	1.0	20	-40 to +150	1.4	1.0	10	0.5	150 (Tj)	50	100/100	35	100/200	22	0.13	1		
		RG 10	1.2	50	-40 to +150	1.8	1.5	500	2.5	100	100	100/100	50	100/200	15	0.4	4		
		RG 2	1.2	50	-40 to +150	1.8	1.5	500	2.5	100	100	100/100	50	100/200	12	0.6	5		
		EL 1	1.5	40	-40 to +150	1.3	1.5	10	0.05	100	100	100/100	50	100/200	17	0.3	3		
		RL 2	2.0	40	-40 to +150	1.3	2.0	10	0.1	150 (Tj)	50	100/100	35	100/200	12	0.6	5		
		RL 31*	3.0	70	-40 to +150	1.3	3.0	50	0.1	150 (Tj)	50	100/100	35	100/200	10	1.0	6		
		RL 3	3.5	80	-40 to +150	1.3	3.5	100	0.2	150 (Tj)	50	100/100	35	100/200	10	1.0	6		
	RG 4	1.0 (3.0)	80	-40 to +150	1.8	3.0	500	2.5	100	100	100/100	50	100/200	8	1.2	7			
	Frame-2Pin	FML-G14S	5.0	70	-40 to +150	1.3	5.0	100	0.2	100	50	100/100	35	100/200	4.0	2.1	8	72	
		FMN-G14S	5.0	70	-40 to +150	1.0	5.0	50	10	150 (Tj)	100	100/100	50	100/200	4.0	2.1	8	—	
		FMX-G14S*	5.0	70	-40 to +150	1.3	5.0	50	15	150	30	100/100	25	100/200	4.0	2.1	8	—	
	Center-tap	FMG-14S, R	5.0	35	-40 to +150	2.0	2.5	500	1.5	100	100	100/100	50	100/200	4.0	2.1	9	75	
		FML-14S	5.0	40	-40 to +150	1.3	2.5	50	0.1	100	50	100/100	35	100/200	4.0	2.1	9	76	
		FMG-24S, R	8.0	65	-40 to +150	2.0	5.0	500	2.5	100	100	100/100	50	100/200	4.0	2.1	9	75	
		FML-24S	10.0	70	-40 to +150	1.3	5.0	100	0.2	100	50	100/100	35	100/200	4.0	2.1	9	76	
		FMG-34S, R	16.0	100	-40 to +150	2.0	10.0	1000	5	100	100	100/100	50	100/200	2.0	5.5	10	77	
FML-34S		20.0	100	-40 to +150	1.3	10.0	200	0.4	100	50	500/500	35	500/1000	2.0	5.5	10	78		

* : Under development

External Dimensions

Flammability: UL94V-0 or Equivalent (Unit: mm)

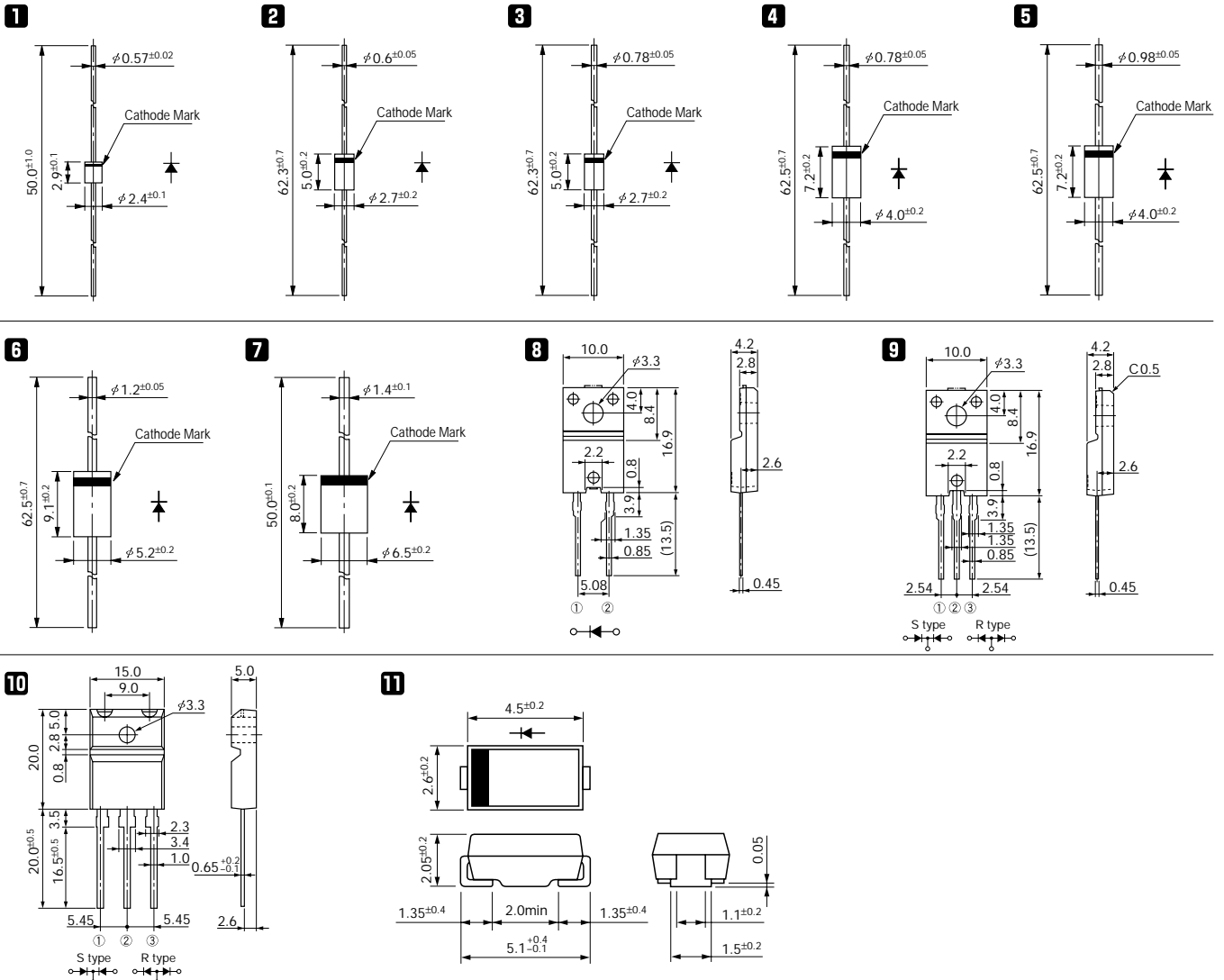

Ultra-Fast-Recovery Rectifier Diodes **600V**

$t_{rr} \textcircled{1}$: $I_F/I_R (=I_F)$ 90% Recovery Point
 (ex. $I_F/I_R = 100\text{mA}/100\text{mA}$ 90% Recovery Point)
 $t_{rr} \textcircled{2}$: $I_F/I_R (=2 I_F)$ 75% Recovery Point
 (ex. $I_F/I_R = 100\text{mA}/200\text{mA}$ 75% Recovery Point)

V _{RM} (V)	Package	Part Number	I _F (AV) (A)	I _{FSM} (A)	T _j (°C)	T _{stg} (°C)	V _F (V)	I _F (A)	I _R (μA)	I _R (H) (mA)	T _a (°C)	t _{rr} ① (ns)		t _{rr} ② (ns)		R _{th} (j-ℓ) R _{th} (j-c) (°C/W)	Mass (g)	Fig. No.	Page where characteristic curve is shown
				50Hz Half-cycle Sinewave Single Shot					V _R = V _{RM} max	V _R = V _{RM} max		I _F /I _{FP} (mA)	I _F /I _{FP} (mA)						
600	Surface Mount	MP3-306	30.0	180	-40 to +150	1.7	30.0	100	0.5	150 (T _j)	150	500/500	70	500/1000	2.0	1.04	13	80	
	Axial	AG01A	0.5	15	-40 to +150	1.8	0.5	100	0.5	100	100	100/100	50	100/200	22	0.13	1	64	
		EG01A	0.5	10	-40 to +150	2.0	0.5	100	0.5	100	100	100/100	50	100/200	20	0.2	2	65	
		EG 1A	0.6	10	-40 to +150	2.0	0.6	100	0.5	100	100	100/100	50	100/200	17	0.3	3	66	
		RG 10A	1.0	50	-40 to +150	2.0	1.0	500	2.5	100	100	100/100	50	100/200	15	0.4	4		
		RG 2A	1.0	50	-40 to +150	2.0	1.0	500	2.5	100	100	100/100	50	100/200	12	0.6	5	68	
		RD 2A	1.2	30	-40 to +150	1.55	1.2	50	0.1	150	50	100/100	35	100/200	12	0.6	5		
		RL 3A	2.0	60	-40 to +150	1.7	3.0	50	0.2	150 (T _j)	50	100/100	35	100/200	10	1.0	6	69	
		RG 4A	1.0 (2.0)	50	-40 to +150	2.0	2.0	500	2.5	100	100	100/100	50	100/200	8	1.2	7		
		RL 4A	3.0	80	-40 to +150	1.5	3.0	50	0.1	150 (T _j)	50	500/500	35	500/1000	8	1.2	7	71	
	Frame-2Pin	FMG-G26S	4.0	50	-40 to +150	2.5	4.0	500	3.0	100	100	100/100	50	100/200	4.0	2.1	8	72	
		FML-G16S	5.0	50	-40 to +150	1.5	5.0	100	0.5	100	50	500/500	35	500/1000	4.0	2.1			
		FMX-G16S	5.0	50	-40 to +150	1.5	5.0	50	15	150	30	500/500	25	500/1000	4.0	2.1			
		FMN-G16S*	5.0	50	-40 to +150	1.2	5.0	50	10	150 (T _j)	100	100/100	50	100/200	4.0	2.1			
		FMD-G26S	10.0	100	-40 to +150	1.7	10.0	100	0.3	150	50	500/500	30	500/1000	4.0	2.1			
		FMX-G26S	10.0	100	-40 to +150	1.5	10.0	100	20	150	30	500/500	25	500/1000	4.0	2.1			
		FMG-G36S	8.0	80	-40 to +150	2.5	8.0	500	3	100	100	500/500	50	500/1000	2.0	5.5		9	74
	Center-tap	FMC-26U	3.0	50	-40 to +150	2.0	3.0	500	3	150 (T _j)	70	500/500	35	500/1000	4.0	2.1	10	74	
		FMG-26S, R	6.0	50	-40 to +150	2.2	3.0	500	3	100	100	100/100	50	100/200	4.0	2.1	11	75	
		FMG-36S, R	15.0	80	-40 to +150	2.2	7.5	1000	5	100	100	100/100	50	100/200	2.0	5.5	12	78	
FML-36S		20.0	100	-40 to +150	1.7	10.0	100	0.3	100	65	500/500	35	500/1000	2.0	5.5				

* : Under development

Ultra-Fast-Recovery Rectifier Diodes 600V

External Dimensions Flammability: UL94V-0 or Equivalent (Unit: mm)

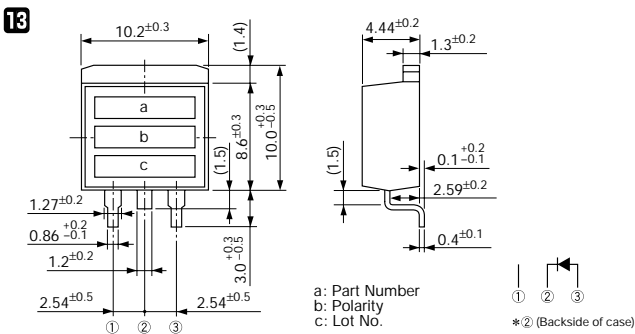
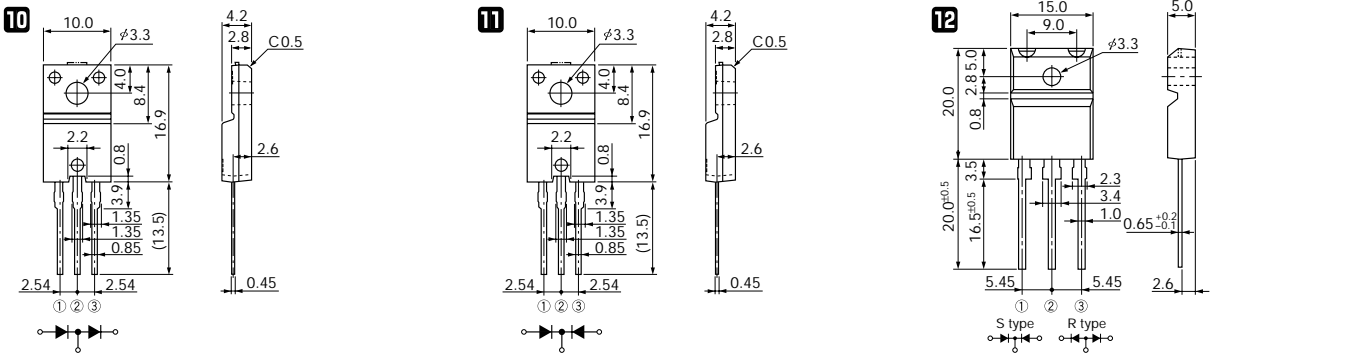
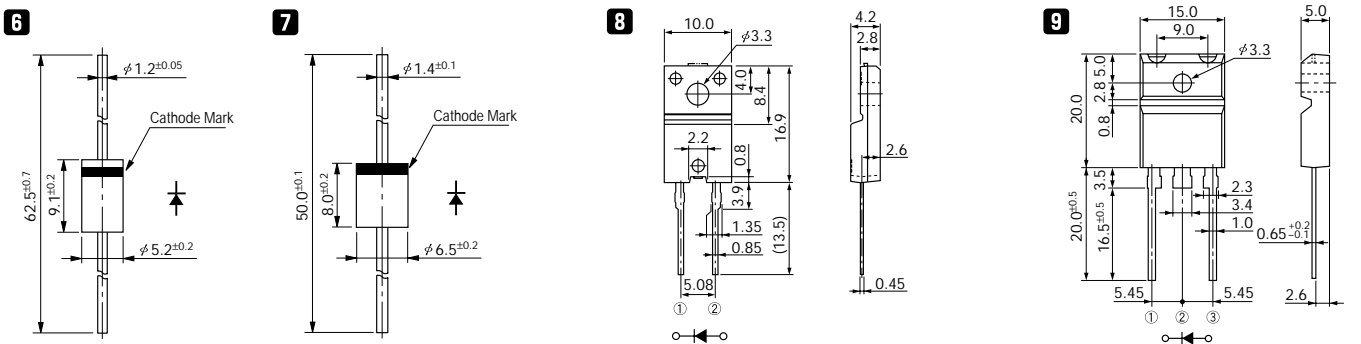
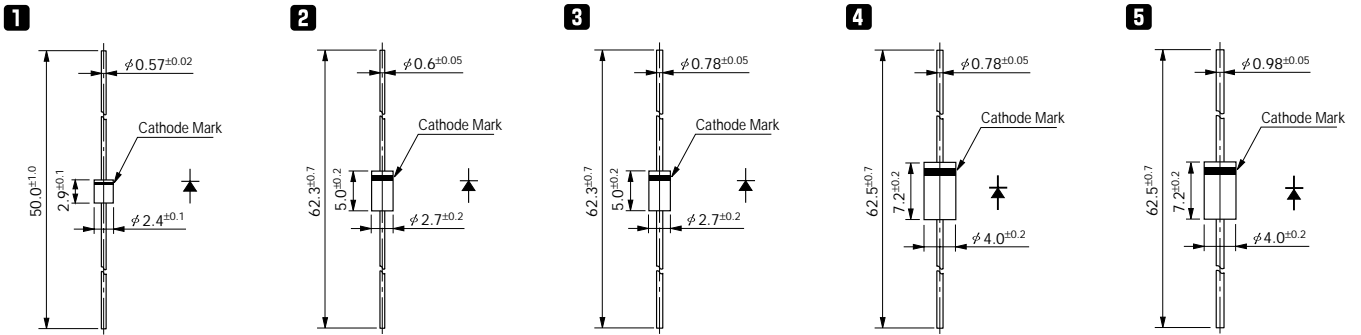

Ultra-Fast-Recovery Rectifier Diodes 800V

$t_{rr} \text{ ①: } I_F/I_R (=I_F) \text{ 90\% Recovery Point}$
 (ex. $I_F/I_R = 100\text{mA}/100\text{mA}$ 90% Recovery Point)
 $t_{rr} \text{ ②: } I_F/I_R (=2 I_F) \text{ 75\% Recovery Point}$
 (ex. $I_F/I_R = 100\text{mA}/200\text{mA}$ 75% Recovery Point)

V_{RM} (V)	Package	Part Number	I_F (AV) (A)	I_{FSM} (A)	T_j (°C)	T_{stg} (°C)	V_F (V) max	I_F (A)	I_R (μ A)	I_R (H) (mA)	T_a (°C)	t_{rr} ① (ns)		t_{rr} ② (ns)		R_{th} (j-c) (°C/W)	Mass (g)	Fig. No.	Page where characteristic curve is shown
				50Hz Half-cycle Sinewave Single Shot					$V_R = V_{RM}$ max	$V_R = V_{RM}$ max		I_F/I_{FP} (mA)	I_F/I_{FP} (mA)						
800	Frame-2Pin	FMC-G28S	3.0	50	-40 to +150	3.0	3.0	100	1	150 (Tj)	70	500/500	35	500/1000	4.0	2.1	1	71	
		FMC-G28SL	5.0	60	-40 to +150	3.0	5.0	200	2	150 (Tj)	70	500/500	35	500/1000	4.0	2.1			
	Center-tap	FMC-28U	3.0	50	-40 to +150	3.0	3.0	100	0.5	150 (Tj)	70	500/500	35	500/1000	4.0	2.1	2	74	

External Dimensions

Flammability: UL94V-0 or Equivalent (Unit: mm)

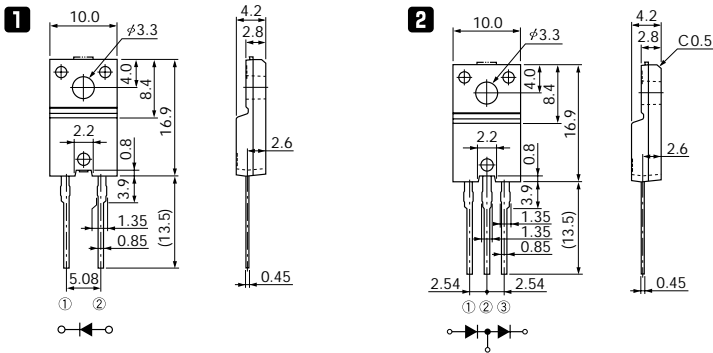

Ultra-Fast-Recovery Rectifier Diodes 1000V

$t_{rr} \text{ ①: } I_F/I_R (=I_F) \text{ 90\% Recovery Point}$
 (ex. $I_F/I_R = 100\text{mA}/100\text{mA}$ 90% Recovery Point)
 $t_{rr} \text{ ②: } I_F/I_R (=2 I_F) \text{ 75\% Recovery Point}$
 (ex. $I_F/I_R = 100\text{mA}/200\text{mA}$ 75% Recovery Point)

V_{RM} (V)	Package	Part Number	I_F (AV) (A)	I_{FSM} (A)	T_j (°C)	T_{stg} (°C)	V_F (V) max	I_F (A)	I_R (μ A)	I_R (H) (mA)	T_a (°C)	t_{rr} ① (ns)		t_{rr} ② (ns)		R_{th} (j-c) (°C/W)	Mass (g)	Fig. No.	Page where characteristic curve is shown
				50Hz Half-cycle Sinewave Single Shot					$V_R = V_{RM}$ max	$V_R = V_{RM}$ max		I_F/I_{FP} (mA)	I_F/I_{FP} (mA)						
1000	Axial	AP01C	0.2	5	-40 to +150	4.0	0.2	100	0.5	100	200	100/100	80	100/200	22	0.13	1	63	
		EP01C	0.2	5	-40 to +150	4.0	0.2	5	0.05	100	200	100/100	80	100/200	20	0.2	2		
		RU 1P	0.4	10	-40 to +150	4.0	0.4	5	0.05	100	100	100/100	50	100/200	15	0.4	3		67
		EG01C	0.5	10	-40 to +150	3.3	0.5	50	0.5	100	100	100/100	50	100/200	20	0.2	2		65
		RG 1C	0.7	10	-40 to +150	3.3	0.7	20	0.25	100	100	100/100	50	100/200	15	0.4	3		66
		RG 4C	1.0 (2.0)	60	-40 to +150	3.0	2.0	500	2.5	100	100	500/500	50	500/1000	8	1.2	4		70
	Frame-2Pin	FMG-G2CS	4.0	30	-40 to +150	4.0	3.0	50	0.3	100	100	500/500	50	500/1000	4.0	2.1	5	72	
		FMG-G3CS	5.0	60	-40 to +150	3.5	5.0	100	0.5	100	150	500/500	70	500/1000	2.0	5.5	6	74	

External Dimensions Flammability: UL94V-0 or Equivalent (Unit: mm)

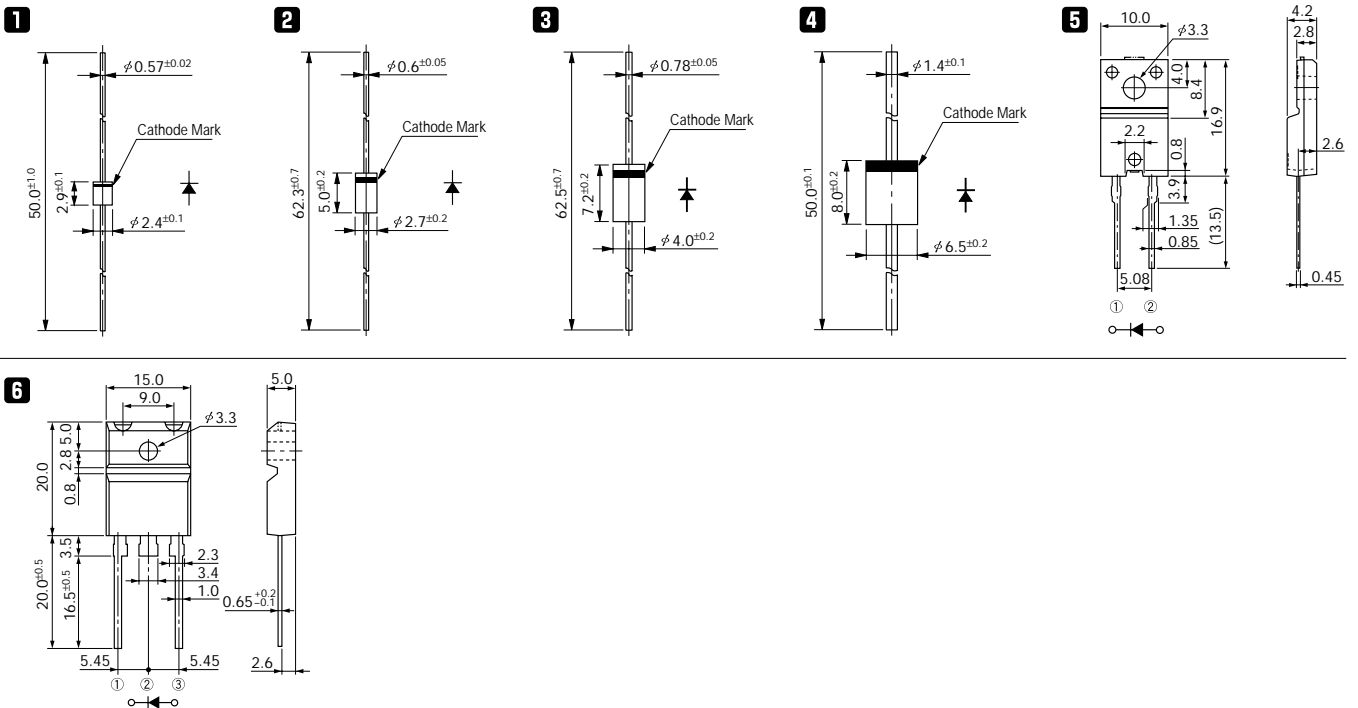

Ultra-Fast-Recovery Rectifier Diodes 1200V and over

$t_{rr} \textcircled{1}$: $I_F/I_R (=I_F)$ 90% Recovery Point
 (ex. $I_F/I_R = 100\text{mA}/100\text{mA}$ 90% Recovery Point)
 $t_{rr} \textcircled{2}$: $I_F/I_R (=2I_F)$ 75% Recovery Point
 (ex. $I_F/I_R = 100\text{mA}/200\text{mA}$ 75% Recovery Point)

V_{RM} (V)	Package	Part Number	I_F (AV) (A)	I_{FSM} (A) 50Hz Half-cycle Sinewave Single Shot	T_j (°C)	T_{stg} (°C)	V_F (V) max	I_F (A)	I_R (μ A) $V_R = V_{RM}$ max	I_R (H) (mA) $V_R = V_{RM}$ max	T_a (°C)	$t_{rr} \textcircled{1}$ (ns)		$t_{rr} \textcircled{2}$ (ns)		$R_{th(j-l)}$ $R_{th(j-c)}$ (°C/W)	Mass (g)	Fig. No.	Page where characteristic curve is shown
												I_F/I_{FP} (mA)	I_F/I_{FP} (mA)						
1200	Frame-2Pin	FMC-26UA	3.0	50	-40 to +150	4.0	3.0	500	3.0	150 (Tj)	70	500/500	35	500/1000	4.0	2.1	1	74	
1600	Frame-2Pin	FMC-28UA	3.0	50	-40 to +150	6.0	3.0	100	0.5	150 (Tj)	70	500/500	35	500/1000	4.0	2.1			
2000	Axial	RP 1H	0.1	5	-40 to +150	7.0	0.1	2	0.01	100	100	10/10	50	10/20	15	0.4	2	67	

External Dimensions

Flammability: UL94V-0 or Equivalent (Unit: mm)

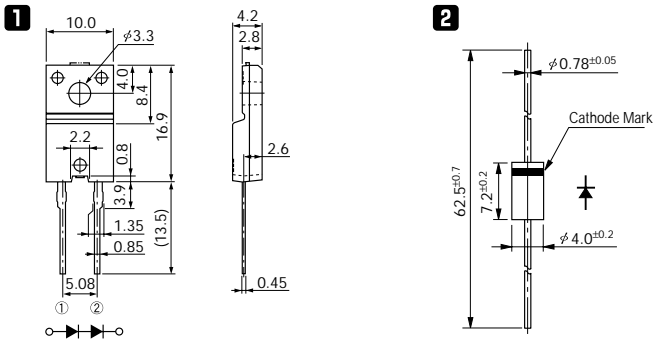

Schottky Barrier Diodes 30V

V _{RM} (V)	Package	Part Number	I _F (AV) (A)	I _{FSM} (A)	T _J (°C)	T _{stg} (°C)	V _F (V) max	I _F (A)	I _R (mA)	I _R (H) (mA)	R _{th} (j-ℓ) R _{th} (j-c) (°C/W)	Mass (g)	Fig. No.	Page where characteristic curve is shown		
				50Hz Half-cycle Sinewave Single Shot					V _R =V _{RM} max	V _R =V _{RM} max					T _a (°C)	
30	Surface Mount	MI1A3	1.0	12	-40 to +150	0.47	1.0	1	70	150 (Tj)	70	0.011	1	82		
		MI2A3 *	1.0	12	-40 to +125	0.39	1.0	2	110	125 (Tj)	70	0.011				
		SFPA-53	1.0	30	-40 to +125	0.36	1.0	1.5	70	100	20	0.072			2	—
		SFPJ-53 *	1.0	30	-40 to +150	0.45	1.0	1.0	35	150	20	0.072				
		SFPA-63	2.0	40	-40 to +125	0.36	2.0	3.0	140	100	20	0.072				
		SFPE-63 *	2.0	40	-40 to +150	0.55	2.0	0.2	20	150 (Tj)	20	0.072				
		SFPJ-63	2.0	40	-40 to +150	0.45	2.0	2.0	70	150	20	0.072				
		SFPA-73	3.0	50	-40 to +125	0.36	3.0	4.5	210	100	20	0.072				
		SFPJ-73	3.0	50	-40 to +150	0.45	3.0	3.0	100	150	20	0.072				
		SPJ-G53S	5.0	100	-40 to +150	0.45	5.0	5.0	250	150	5	0.29				
	Surface Mount Center-tap	SPJ-63S	6.0	50	-40 to +150	0.45	3.0	3	100	150 (Tj)	5	0.29	3			
	Axial	AK 03	1.0	25	-40 to +150	0.55	1.0	1	50	100 (Tj)	22	0.13	4	85		
		EA 03	1.0	30	-40 to +125	0.36	1.0	1.5	70	100	20	0.3	5	—		
		EK 03	1.0	40	-40 to +150	0.55	1.0	5	50	100	20	0.3	6	86		
		EK 13	1.5	40	-40 to +150	0.55	2.0	5	50	100	17	0.3	6	86		
		RK 13	1.7	60	-40 to +150	0.55	2.0	5	50	100	15	0.45	7	87		
		RA 13	2.0	40	-40 to +125	0.36	2.0	3	140	100	15	0.45	7	—		
		RK 33	2.5	50	-40 to +150	0.55	2.5	5	50	100	12	0.6	8	87		
		RJ 43	3.0	50	-40 to +150	0.45	3.0	3	100	150	8	1.2	9	—		
		RK 43	3.0	80	-40 to +150	0.55	3.0	5	50	100	8	1.2	9	88		
Center-tap		FMJ-23L	10	100	-40 to +150	0.45	5.0	5	250	150 (Tj)	4	2.1	10	93		
	FMJ-2203	20	150	-40 to +150	0.47	10.0	10	350	150	4	2.1	10	—			
	FMJ-2303	30	150	-40 to +150	0.48	15.0	15	500	150	4	2.1	10	—			

External Dimensions

Flammability: UL94V-0 or Equivalent (Unit: mm)

* : Under development

1

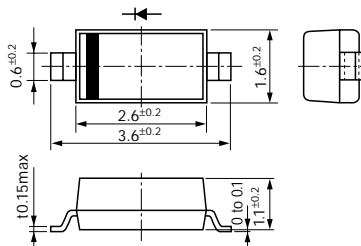

2

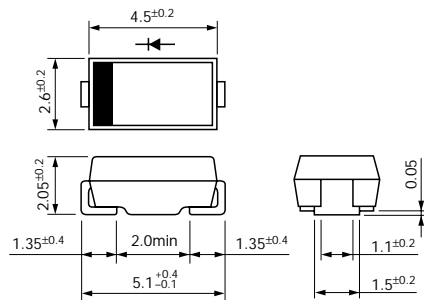

3

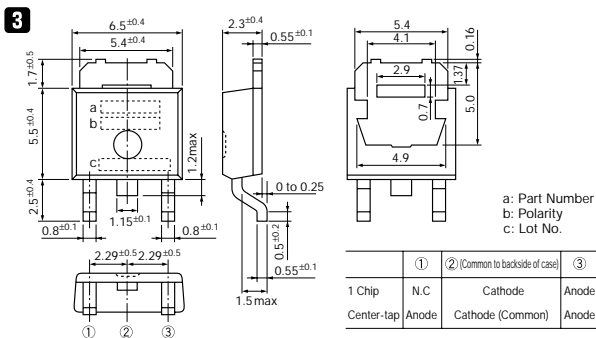

4

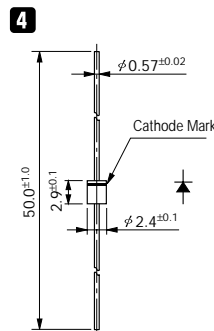

5

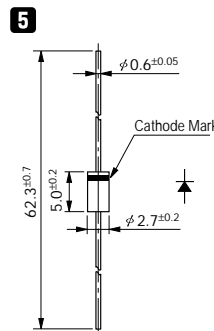

6

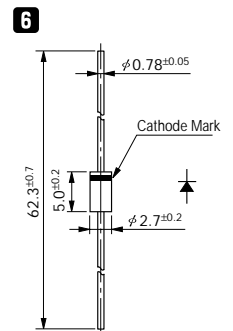

7

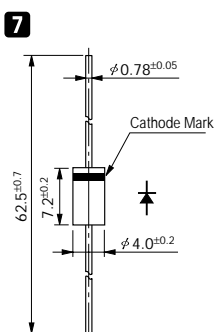

8

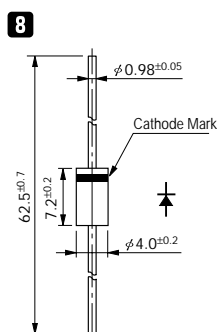

9

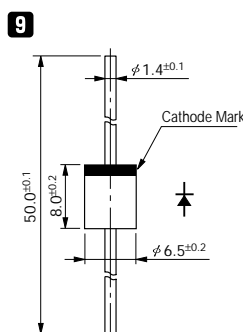

10

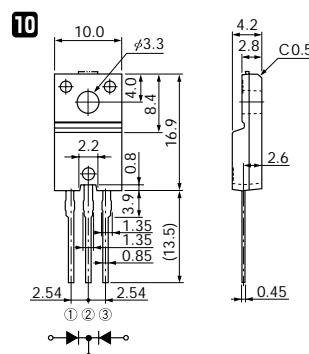

Schottky Barrier Diodes

40V

V _{RM} (V)	Package	Part Number	I _F (AV) (A)	I _{FSM} (A)	T _J (°C)	T _{stg} (°C)	V _F (V) max	I _F (A)	I _R (mA)	I _R (H) (mA)	Ta (°C)	R _{th} (j-ℓ) R _{th} (j-c) (°C/W)	Mass (g)	Fig. No.	Page where characteristic curve is shown
				50Hz Half-cycle Sinewave Single Shot					V _R =V _{RM} max	V _R =V _{RM} max					
40	Surface Mount	SFPB-54	1.0	30	-40 to +150	0.55	1.0	1	50	100	20	0.072	1	82	
		SFPB-64	1.5	60	-40 to +150	0.55	2.0	5	50	100	20	0.072		83	
		SFPB-74	2.0	60	-40 to +150	0.5	2.0	5	50	100	20	0.072		—	
		SPB-G34S	3.0	50	-40 to +150	0.55	3.0	3.5	50	100	5	0.29	2	84	
		SPB-G54S	5.0	60	-40 to +150	0.55	5.0	5	50	100	5	0.29			
		Surface Mount Center-tap	SPB-64S	6.0	50	-40 to +150	0.55	3.0	3.5	50	100	5	0.29		
	Axial	AK 04	1.0	25	-40 to +150	0.55	1.0	1	50	100 (Tj)	22	0.13	3	85	
		AW 04	1.0	25	-40 to +150	0.58	1.0	5	35	150	22	0.13		—	
		AE 04	1.0	25	-40 to +150	0.6	1.0	0.1	10	150 (Tj)	22	0.13		—	
		EK 04	1.0	40	-40 to +150	0.55	1.0	5	50	100	20	0.3	4	86	
		EE 04 *	2.0	40	-40 to +150	0.6	2.0	0.2	20	150 (Tj)	20	0.3		—	
		EK 14	1.5	40	-40 to +150	0.55	2.0	5	50	100	17	0.3	5	86	
		RK 14	1.7	60	-40 to +150	0.55	2.0	5	50	100	15	0.45		6	87
		RK 34	2.5	50	-40 to +150	0.55	2.5	5	50	100	12	0.6	7		
	RK 44	3.0	80	-40 to +150	0.55	3.0	5	50	100	8	1.2	8		88	
	Frame-2Pin	FMB-G14	3.0	60	-40 to +150	0.55	3.0	5	100	100	4		2.1		9
		FMB-G14L	5.0	60	-40 to +150	0.55	5.0	5	100	100	4	2.1			
		FMB-G24H	10.0	150	-40 to +150	0.55	10.0	10	65	100	4	2.1			
	Center-tap	MPE-24H	15	100	-40 to +150	0.6	7.5	0.75	50	150 (Tj)	2.5	1.04	10/10	85	
		FMB-24	4.0	50	-40 to +150	0.55	2.0	5	35	100	4	2.1	11	90	
		FMB-24M	6.0	60	-40 to +150	0.55	3.0	5	35	100	4	2.1		91	
		FMW-24L	10.0	100	-40 to +150	0.55	5.0	5	175	150	4	2.1		90	
		FMB-24L	10	60	-40 to +150	0.55	5.0	5	35	100	4	2.1	12	94	
		FME-2104	10	80	-40 to +150	0.6	5.0	0.5	30	100	4	2.1			92
		FMB-34S	12	75	-40 to +150	0.58	6	5	35	100	2	5.5	11	90	
		FMW-24H	15	120	-40 to +150	0.55	7.5	7.5	250	150	4	2.1			92
		FME-24H	15	100	-40 to +150	0.6	7.5	0.75	50	100	4	2.1	12	93	
		FMB-24H	15	100	-40 to +150	0.55	7.5	7.5	50	100	4	2.1			90
FMB-34		15	150	-40 to +150	0.55	7.5	10	65	100	2	5.5	11	81		
FMB-2204		20	150	-40 to +150	0.55	10	10	350	150	4	2.1			91	
FMW-2204		20	120	-40 to +150	0.55	10	10	350	150 (Tj)	4	2.1	12	93		
FMB-2304		30	150	-40 to +150	0.55	15	15	500	150	4	2.1			91	
FMB-34M	30	300	-40 to +150	0.55	15.0	20	100	100	2	5.5					

* : Under development

Schottky Barrier Diodes 40V

External Dimensions Flammability: UL94V-0 or Equivalent (Unit: mm)

1

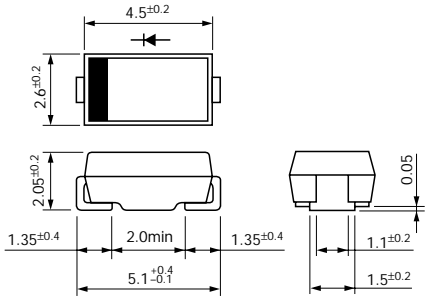

2

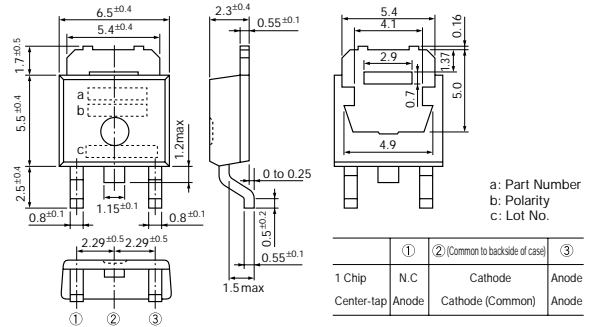

3

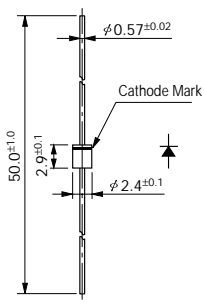

4

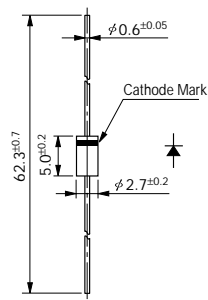

5

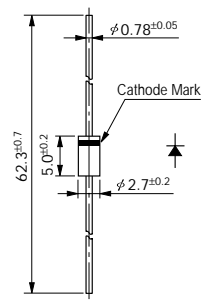

6

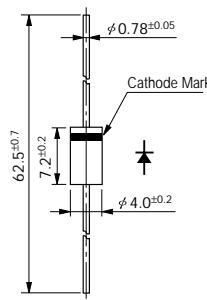

7

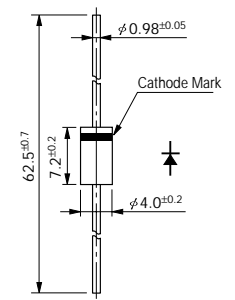

8

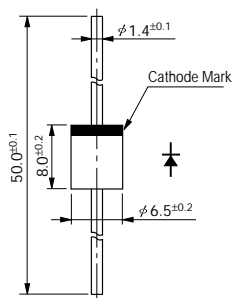

9

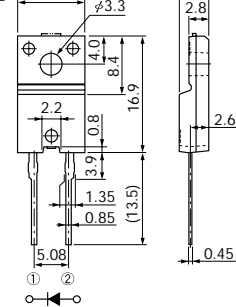

10

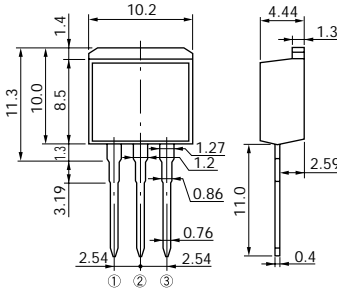

10

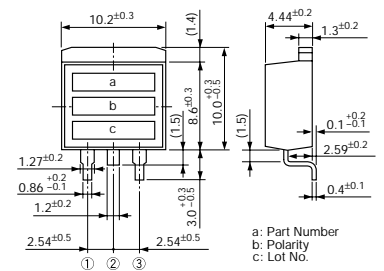

11

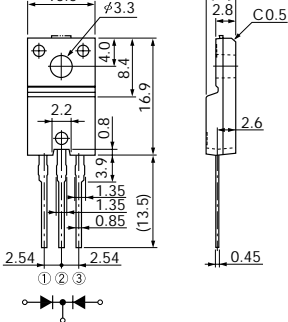

12

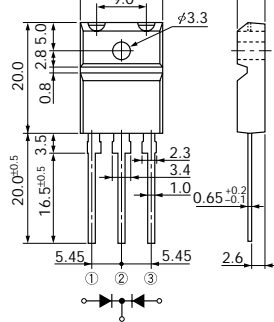

Schottky Barrier Diodes

90V and over

V _{RM} (V)	Package	Part Number	I _F (AV) (A)	I _{FSM} (A)	T _J (°C)	T _{stg} (°C)	V _F (V) max	I _F (A)	I _R (mA)	I _R (H) (mA)	T _a (°C)	R _{th(j-l)} R _{th(j-c)} (°C/W)	Mass (g)	Fig. No.	Page where characteristic curve is shown
				50Hz Half-cycle Sinewave Single Shot					V _R =V _{RM} max	V _R =V _{RM} max					
90	Surface Mount	SFPB-59	0.7	10	-40 to +150	0.81	0.7	1	5	100	20	0.072	1	82	
		SFPB-69	1.5	40	-40 to +150	0.81	1.5	2	10	100	20	0.072		83	
	Axial	AK 09	0.7	10	-40 to +150	0.81	0.7	1	5	100	22	0.13	2	85	
		EK 09	0.7	10	-40 to +150	0.81	0.7	1	5	100	20	0.3	3	86	
		EK 19	1.5	40	-40 to +150	0.81	1.5	2	10	100	17	0.3	4	87	
		RK 19	1.5	40	-40 to +150	0.81	1.5	2	10	100	15	0.45	5		
		RK 39	2.0	50	-40 to +150	0.81	2.0	3	15	100	12	0.6	6	88	
		RK 49	3.5	60	-40 to +150	0.81	3.5	5	35	100	8	1.2	7		
	Frame-2Pin	FMB-G19L	4.0	60	-40 to +150	0.81	4.0	5	35	100	4	2.1	8	89	
	Center-tap	FMB-29	4.0	50	-40 to +150	0.81	2.0	3	15	100	4	2.1	10	92	
		FMB-29L	8.0	60	-40 to +150	0.81	4.0	5	35	100	4	2.1			
FMB-39		15	60	-40 to +150	0.81	7.5	10	50	100	2	5.5	11	94		
MPE-29G		20	120	-40 to +150	0.85	10	1	100	150 (Tj)	2.5	1.04	9/8	85		
FMB-39M		20	150	-40 to +150	0.81	10.0	15	60	100	2	5.5	11	94		
100	Center-tap	FME-220A	20	120	-40 to +150	0.85	10	1	100	150 (Tj)	4	2.1	10	93	
		FME-230A	30	150	-40 to +150	0.85	15	1.5	150	150 (Tj)	4	2.1			

External Dimensions Flammability: UL94V-0 or Equivalent (Unit: mm)

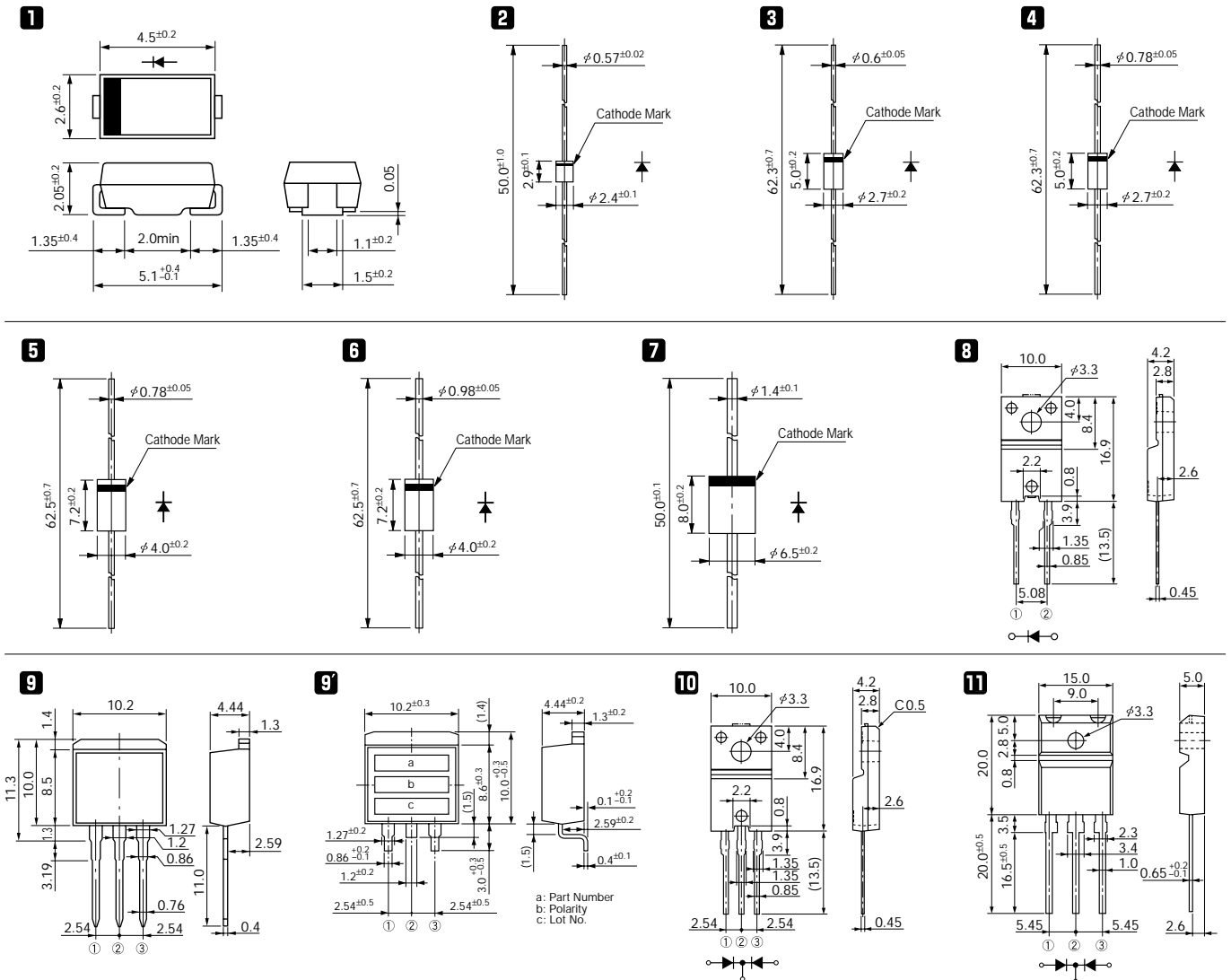

Damper Diodes

$t_{rr} \textcircled{1}$: $I_F/I_R (=I_F)$ 90% Recovery Point
 (ex. $I_F/I_R = 100\text{mA}/100\text{mA}$ 90% Recovery Point)
 $t_{rr} \textcircled{2}$: $I_F/I_R (=2 I_F)$ 75% Recovery Point
 (ex. $I_F/I_R = 100\text{mA}/200\text{mA}$ 75% Recovery Point)

Division	V_{RM} (V)	Part Number	I_F (AV) (A) () is with Heatsink	I_{FSM} (A) 50Hz Half-cycle Sinewave Single Shot	T_j (°C)	T_{stg} (°C)	V_F (V) max	I_F (A)	I_R (μ A) $V_R=V_{RM}$ max	I_R (H) (mA) $V_R=V_{RM}$ max	T_a (°C)	$t_{rr} \textcircled{1}$ (μ s)		$t_{rr} \textcircled{2}$ (μ s)		$R_{th} (j-l)$ $R_{th} (j-c)$ (°C/W)	Mass (g)	Fig. No.	Page where characteristic curve is shown	
												I_F/I_{FP} (mA)	I_F/I_{FP} (mA)							
For TV	1300	RH 2D	1.0	60	-40 to +150	1.0	1.0	10	0.5	100	4.0	10/10	1.3	100/200	12	0.6	1	96		
		RH 10F	0.8	60	-40 to +150	1.0	1.0	10	0.5	100	4.0	10/10	1.3	100/200	15	0.44	2			
		RH 2F	1.0	60	-40 to +150	1.0	1.0	10	0.5	100	4.0	10/10	1.3	100/200	12	0.6	1			
		RS 3FS	2.0	50	-40 to +150	1.1	3.0	50	0.5	100	2.0	100/100	0.8	100/200	10	1.0	3			
		RH 3F	2.5	50	-40 to +150	1.3	2.5	50	0.5	100	4.0	100/100	1.3	100/200	10	1.0	3	97		
		RS 4FS	1.5 (2.5)	50	-40 to +150	1.5	3.0	50	0.5	100	1.0	100/100	0.4	100/200	8	1.2	4			
		RH 4F	2.5	50	-40 to +150	1.5	2.5	10	0.35	100	4.0	100/100	1.3	100/200	8	1.2	4	96		
		1600	RH 3G	2.5	50	-40 to +150	1.3	2.5	50	0.5	100	4.0	100/100	1.3	100/200	10	1.0	3		
		1700	FMV-G2GS	6.0	50	-40 to +150	1.5	6.0	50	3	150 (Tj)	2.0	500/500	0.8	500/1000	4	2.1	6	98	
	1800	FMR-G5HS	10	50	-40 to +150	1.6	10	20	0.2	100	1.8	500/500	0.7	500/1000	2	6.5	5	99		
For CRT Display	1300	RU 4D	1.2 (1.5)	50	-40 to +150	1.8	1.5	50	0.5	100	0.4	500/500	0.18	500/1000	8	1.2	4	97		
		RU 4DS	1.5 (2.5)	50	-40 to +150	1.8	3.0	50	0.5	100	0.4	500/500	0.18	500/1000	8	1.2	4			
		RP 3F	2.0	50	-40 to +150	1.7	2.0	50	0.5	100	0.7	500/500	0.3	500/1000	10	1.0	3	96		
		FMQ-G1FS	5.0	50	-40 to +150	2.0	5.0	50	0.5	150	0.7	500/500	0.3	500/1000	4	2.1	6	98		
		FMQ-G2FLS	10	50	-40 to +150	1.8	10.0	50	0.5	150 (Tj)	1.2	500/500	0.4	500/1000	4	2.1	6			
		FMU-G2FS	10	50	-40 to +150	1.6	10	50	6	150 (Tj)	0.6	500/500	0.25	500/1000	4	2.1	6	99		
		FMQ-G2FS	10	50	-40 to +150	2.8	10	50	0.5	150 (Tj)	0.5	500/500	0.2	500/1000	4	2.1	6	98		
		FMQ-G2FMS	10	50	-40 to +150	2.4	10	50	0.5	150	0.5	500/500	0.25	500/1000	4	2.1	6			
		FMQ-G5FMS	10	50	-40 to +150	2.4	10	50	0.5	100	0.5	500/500	0.2	500/1000	2	6.5	5	99		
	1700	FMQ-G5GS	10	50	-40 to +150	2.7	10	100	0.5	100	0.5	500/500	0.2	500/1000	2	6.5	5			
	1800	FMP-G5HS	8.0	50	-40 to +150	2.0	8.0	25	0.25	100	1.0	500/500	0.4	500/1000	2	6.5	5			
For CRT Display Compensation	1300	RG 2A2	0.5	5	-40 to +150	3.5	0.5	100	0.5	100	0.1	100/100	0.05	100/200	12	0.6	1	97		
	1600	RC 3B2	1.0	20	-40 to +150	3.6	1.0	100	0.5	100	0.07	500/500	0.035	500/1000	10	1.0	3			

External Dimensions

Flammability: UL94V-0 or Equivalent (Unit: mm)

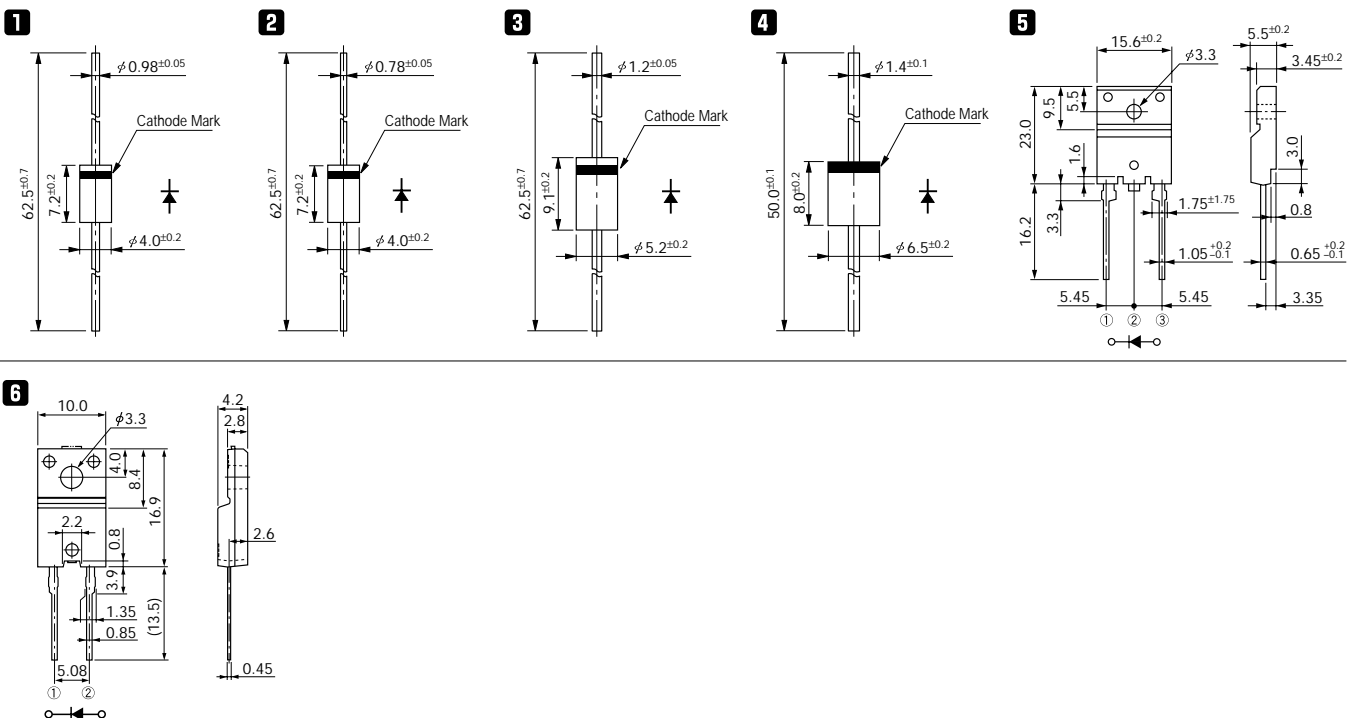

Damper Diodes (Diode modulation Type)

t_{rr} ①: $I_F/I_R (=I_F)$ 90% Recovery Point
 (ex. $I_F/I_R = 100\text{mA}/100\text{mA}$ 90% Recovery Point)
 t_{rr} ②: $I_F/I_R (=2 I_F)$ 75% Recovery Point
 (ex. $I_F/I_R = 100\text{mA}/200\text{mA}$ 75% Recovery Point)

Division	V _{RM} (V)	Part Number	I _F (AV) (A)	I _{FSM} (A)	T _j (°C)	T _{stg} (°C)	V _F (V) max	I _F (A)	I _R (μA)	I _R (H) (mA)	T _a (°C)	t _{rr} ① (μs)		t _{rr} ② (μs)		R _{th} (j-c) (°C/W)	Mass (g)	Fig. No.	Page where characteristic curve is shown
				50Hz Half-cycle Sinewave Single Shot					V _R =V _{RM} max	V _R =V _{RM} max		I _F /I _{FP} (mA)	I _F /I _{FP} (mA)						
For TV	1500	FMV-3FU	5.0	50	-40 to +150	1.4	5.0	50	0.5	100	4.0	500/500	1.3	500/1000	1.8	6.5	1	100	
	600											500/500	0.18	500/1000					
	1700	FMV-3GU	5.0	50	-40 to +150	1.5	5.0	50	0.5	100	2.0	500/500	0.8	500/1000					
	600											500/500	0.18	500/1000					
For CRT Display	1500	FMP-2FUR	5.0	50	-40 to +150	2.0	5.0	50	3	150 (T _j)	0.7	500/500	0.3	500/1000	4.0	2.1	2	102	
	600									150 (T _j)		0.1	500/500	0.05					500/1000
	1500	FMQ-2FUR *	5.0	50	-40 to +150	1.4	5.0	50	2	150	2	500/500	0.8	500/1000					
	600											1.65	5.0	50	0.5	150			0.15
	1500	FMT-2FUR	5.0	50	-40 to +150	1.8	5.0	50	2	150	1.0	500/500	—	500/1000	4.0	2.1	—	—	
	600											1.9	5.0	50					7
	1500	FMP-3FU	5.0	50	-40 to +150	2.0	5.0	50	0.5	100	0.7	500/500	0.3	500/1000	1.8	6.5	1	101	
	600											2.5	5.0	50					0.5
	1700	FMQ-3GU	5.0	50	-40 to +150	2.0	5.0	500	1	100	0.7	500/500	0.3	500/1000					
	800											4.0	5.0	100	0.5	100			0.07

* : Under development

External Dimensions Flammability: UL94V-0 or Equivalent (Unit: mm)

1

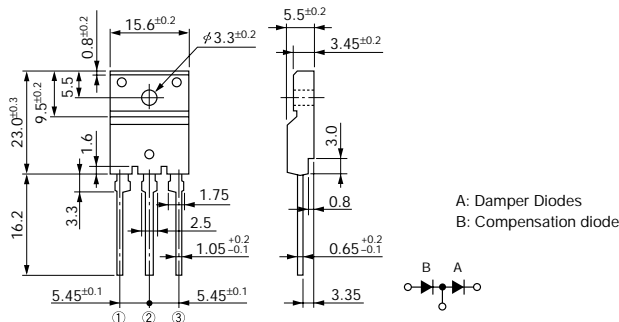

2

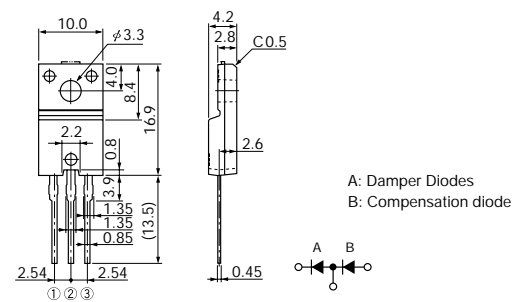

High-Voltage Rectifier Diodes

t_{rr} ①: $I_F/I_R (=I_F)$ 90% Recovery Point
(ex. $I_F/I_R = 100\text{mA}/100\text{mA}$ 90% Recovery Point)

Division	V_{RM} (kV)	Part Number	I_F (AV) (mA)	I_{FSM} (A)	T_c (°C)	T_{stg} (°C)	V_F (V) max	I_F (mA)	I_R (μA)	I_R (H) (μA)	T_a (°C)	t_{rr} ① (μs)		Mass (g)	Fig. No.	
				50Hz Half-cycle Sinewave Single Shot					$V_R = V_{RM}$ max	$V_R = V_{RM}$ max		$T_a = 100^\circ\text{C}$	I_F/I_{FP} (mA)			
For General Purpose	2	SHV-02	2.0	0.3	100	-40 to +120	16	10	1	3	100	0.18	—	10/10	0.13	1
	3	SHV-03S	2.0	0.3	100	-40 to +120	16	10	1	3	100	0.18	—	10/10	0.13	
	3	SHV-03	2.0	0.5	100	-40 to +120	16	10	1	3	100	0.18	—	10/10	0.16	2
For General FBT	10	SHV-10	2.0*	0.5	100	-40 to +120	40	10	1	3	100	0.18	—	10/10	0.33	5
	12	SHV-12	2.0*	0.5	100	-40 to +120	45	10	1	3	100	0.18	—	10/10	0.33	
	14	SHV-14	2.0*	0.5	100	-40 to +120	55	10	1	3	100	0.18	—	10/10	0.33	
	16	SHV-16	2.0*	0.5	100	-40 to +120	60	10	1	3	100	0.18	—	10/10	0.33	
	20	SHV-20	2.0*	0.5	100	-40 to +120	75	10	1	3	100	0.18	—	10/10	0.33	
	24	SHV-24	2.0*	0.5	100	-40 to +120	75	10	1	3	100	0.18	—	10/10	0.33	
For High Frequency Multi-layer FBT	6	SHV-06EN	2.0*	0.5	100	-40 to +120	24	10	1	3	100	0.15	0.20	10/10	0.17	3
	8	SHV-08EN	2.0*	0.5	100	-40 to +120	30	10	1	3	100	0.15	0.20	10/10	0.17	
	10	SHV-10EN	2.0*	0.5	100	-40 to +120	38	10	1	3	100	0.15	0.20	10/10	0.20	
	12	SHV-12EN	2.0*	0.5	100	-40 to +120	45	10	1	3	100	0.15	0.20	10/10	0.20	
For Ultra-High Frequency Multi-layer FBT	8	SHV-08DN	2.0*	0.5	100	-40 to +120	30	10	1	3	100	0.15	0.20	10/10	0.17	3
	10	SHV-10DN	2.0*	0.5	100	-40 to +120	38	10	1	3	100	0.15	0.20	10/10	0.20	
	12	SHV-12DN	2.0*	0.5	100	-40 to +120	45	10	1	3	100	0.15	0.20	10/10	0.20	
For General Type Microwave Oven	9	HVR-1X-40B	350	20	60 (T_a)	-40 to +130	9	350	10	$V_Z = 9.5$ to 15kV		—	—	—	2.5	7
For Inverter Type Microwave Oven	8	UX-F5B	350	15	60 (T_a)	-40 to +130	14	350	10	$V_Z = 8.5\text{kV min}$		0.15	—	100/100	2.5	
For Automotive Ignition Coil	2.5	SHV-05JS	30	3	—	-40 to +150	5	10	10	$V_Z = 2.6$ to 5.0 (@ $I_Z = 100\mu\text{A}$)				0.16	2	
	3.0	SHV-06JN	30	3	—	-40 to +150	6	10	10	$V_Z = 3.2$ to 6.0 (@ $I_Z = 100\mu\text{A}$)				0.17		
	4.0	SHV-08J	30	3	—	-40 to +150	8	10	10	$V_Z = 4.5$ to 8.0 (@ $I_Z = 100\mu\text{A}$)				0.20		
	15.0	SHV-30J	30	3	—	-40 to +150	30	10	10	$V_Z = 16.0$ to 30.0 (@ $I_Z = 100\mu\text{A}$)				0.33		

* FBT High Voltage Rectifier Capacitive Load, $T_c \leq 100^\circ\text{C}$

High-Voltage Rectifier Diodes

Part Number	External dimensions	Marking (Cathode Mark)	
		Pattern	Color
SHV-02	1		White
SHV-03S			Red
SHV-03	2		White
SHV-05J			Red
SHV-06JN	3		White
SHV-06EN			White
SHV-08EN			White
SHV-08DN			Red
SHV-10EN	4		White
SHV-10DN			Red
SHV-12EN			White
SHV-12DN			Red
SHV-10	5		White
SHV-12			
SHV-14			
SHV-16			
SHV-20			
SHV-24			
SHV-30J			
HVR-1X-40B	7		White
UX-F5B			
SHV-08J	8		White

- The SHV series of diodes have been miniaturized by resin on the assumption for remolding. Measures against creeping discharge and humidity stress must be taken when using these diodes.
- The tapping specifications of the SHV series differ from ordinary diodes. (P.10)

Avalanche Diodes with built-in Thyristor

Vz (V)	VRDC (V) (-10°C)	Part Number	ITSM (A) 50Hz Half-cycle Sinewave Single Shot	Tj (°C)	Tstg (°C)	I _R (μA)	I _R (H) (μA)	γ (V/°C) typ	Mass (g)	Fig. No.	Page where characteristic curve is shown	
						VR=VRDC max	VR=VRDC max					Ta (°C)
27 to 33	20	RZ1030	30	-10 to +125	-40 to +150	10	50	100	0.03	0.44	1	103
34 to 40	28	RZ1040	30	-10 to +125	-40 to +150	10	50	100	0.05	0.44		
50 to 60	40	RZ1055	30	-10 to +125	-40 to +150	10	50	100	0.07	0.44		
60 to 70	50	RZ1065	30	-10 to +125	-40 to +150	10	50	100	0.08	0.44		
90 to 110	80	RZ1100	30	-10 to +125	-40 to +150	10	50	100	0.10	0.44		
115 to 135	105	RZ1125	30	-10 to +125	-40 to +150	10	50	100	0.14	0.44	2	104
140 to 160	125	EZ0150	30	-10 to +125	-40 to +150	10	50	100	0.18	0.2		
	125	RZ1150	30	-10 to +125	-40 to +150	10	50	100	0.18	0.44	1	103
150 to 165	138.7	RZ1155	30	-10 to +125	-40 to +150	10	50	100	0.18	0.44		
165 to 185	150	RZ1175	30	-10 to +125	-40 to +150	10	50	100	0.22	0.44		
185 to 215	180	RZ1200	30	-10 to +125	-40 to +150	10	50	100	0.30	0.44		
220 to 250	179.5	RZ1235	30	-10 to +125	-40 to +150	10	50	100	0.30	0.44		
235 to 265	190	RZ1250	30	-10 to +125	-40 to +150	10	50	100	0.30	0.44	104	—

External Dimensions Flammability: UL94V-0 or Equivalent (Unit: mm)

1

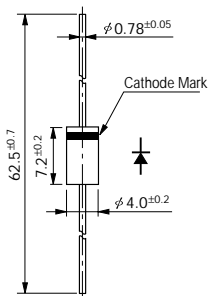

2

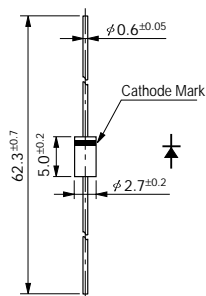

Equivalent circuit diagram

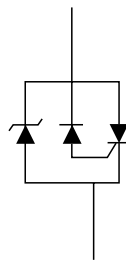

Power Zener Diodes

Vz (V) Iz = 1mA Instantaneous	PR (W) P.W = 5ms	Part Number	VDC (V)	IzSM (A) Rectangular wave single shot 10ms	Tj (°C)	Tstg (°C)	I _R (μA)	I _R (H) (μA)	Ta (°C)	Vz Temperature dependence (V/°C) Iz = 1mA	Rz (Ω) Iz = 1.0A to 10A typ	V _F (V) max	I _F (A)	Mass (g)	Fig. No.	Page where characteristic curve is shown
							V _R = V _{DC} max	V _R = V _{DC} max								
28±3.0	50	SFPZ-68	20	2	-40 to +150	-40 to +150	10	1000	150	0.025	0.026	0.95	1.0	0.072	1	—
28±3.0	1500	PZ 628	20	65	-40 to +150	-40 to +150	500	1000	150	0.036	0.050	0.95	5.0	2.6	2	105
36±3.6	450	SPZ-G36	30	(11)	-40 to +150	-40 to +150	5	1000	150	0.03	0.24	0.98	3.0	0.29	3	—

External Dimensions Flammability: UL94V-0 or Equivalent (Unit: mm)

1

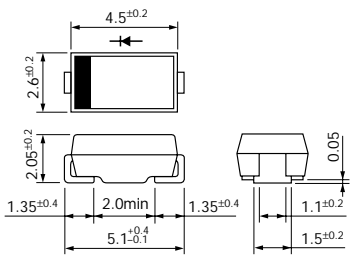

2

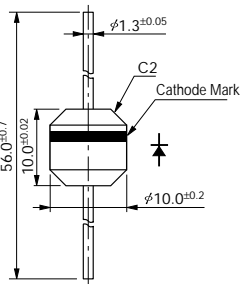

3

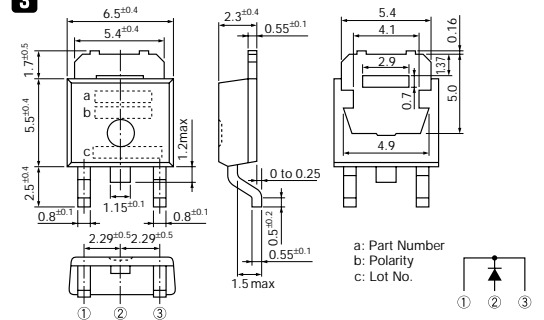

Symmetrical type Silicon Varistors

V _F (V)	I _F (mA)	Part Number	I _F (μA) max	V _F (V)	I _{FSM} (A)	T _J (°C)	T _{stg} (°C)	R _{th(j-ℓ)} (°C/W)	Mass (g)	Fig. No.	Page where characteristic curve is shown
					50Hz Half-cycle Sinewave Single Shot						
1.5 max	1000	VR-60SS	20	0.2	15	-40 to +100		20	0.3	1	106
2.3±0.25	1	VR-61SS			7.5	-40 to +100		20	0.3		
2.75±0.25	10										
3.1±0.25	70										
4.0 max	100	SV-2SS	50	1.2		-40 to +100		20	0.3		
2.0 max	100	SV-3SS	50	0.6		-40 to +100		20	0.3		
1.8±0.2	1	SV-4SS	50	0.9		-40 to +100		20	0.3		
2.15±0.2	10										
2.4±0.25	30										

External Dimensions Flammability: UL94V-0 or Equivalent (Unit: mm)

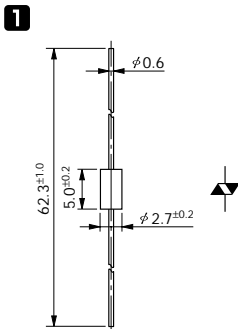

Part Number	VR-60SS	VR-61SS	SV-2SS	SV-3SS	SV-4SS
Color indication					
Internal junction					

Unsymmetrical type Silicon Varistors

V _F (V)	I _F (mA)	Part Number	I _F (μA) max	I _{FSM} (A)	T _j (°C)	T _{stg} (°C)	I _R (μA)	V _R (V)	R _{th(j-ℓ)} (°C/W)	Mass (g)	Fig. No.	Page where characteristic curve is shown
				50Hz Half-cycle Sinewave Single Shot								
1.2±0.2	1	SV 02YS	200	30	-40 to +130	10	100	20	0.3			
1.5±0.25	70											
1.8±0.2	1	SV 03YS	150	16	-40 to +130	10	100	20	0.3			
2.3±0.25	70											
2.35±0.2	1	SV 04YS	100	12	-40 to +130	10	100	20	0.3			
3.0±0.3	70											
3.0±0.3	1	SV 05YS	80	10	-40 to +130	10	100	20	0.3			
3.8±0.4	70											
3.5±0.4	1	SV 06YS	70	8	-40 to +130	10	100	20	0.3			
4.5±0.45	70											

External Dimensions Flammability: UL94V-0 or Equivalent (Unit: mm)

1

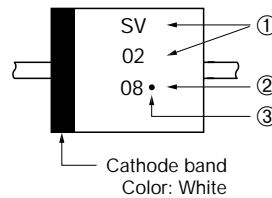
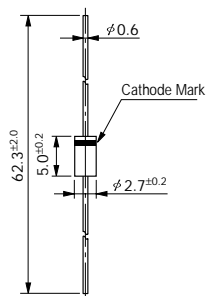

- ① Part Number
- ② Manufacturing date
First character: Year (Last digit of year)
Second character: Month (1 to 9, O, N, D)
- ③ Manufacturing period
 - First 10 days of month
 - Middle 10 days of month
 - Last 10 days of month

Part Number	SV 02YS	SV 03YS	SV 04YS	SV 05YS	SV 06YS
Internal junction	○ ▲ ○	○ ▲ ▲ ○	○ ▲ ▲ ▲ ○	○ ▲ ▲ ▲ ▲ ○	○ ▲ ▲ ▲ ▲ ▲ ○

Characteristic Curves Rectifier Diodes

SFPM-5 series

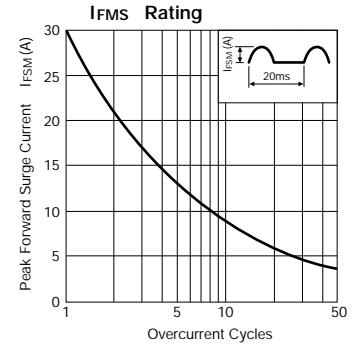
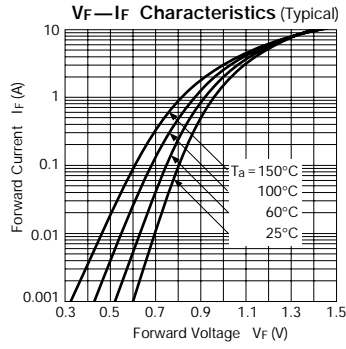
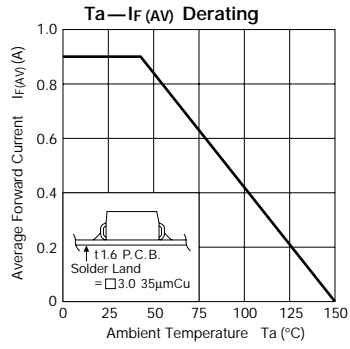

SFPM-6 series

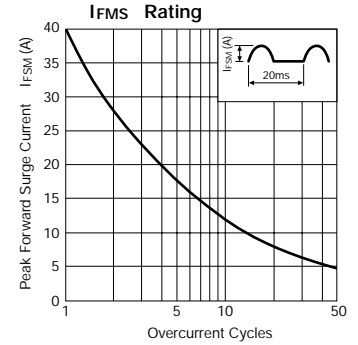
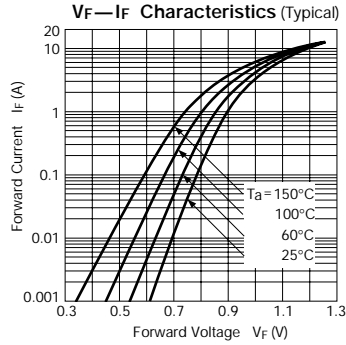
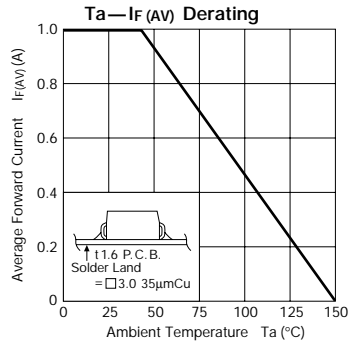

AM01 series

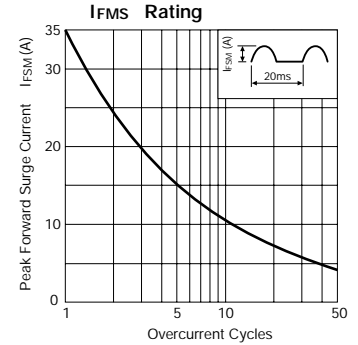
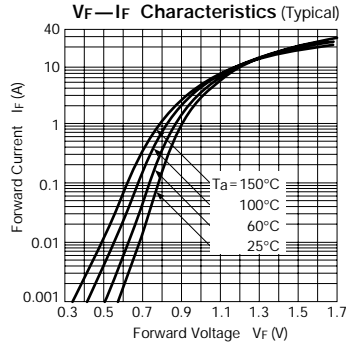
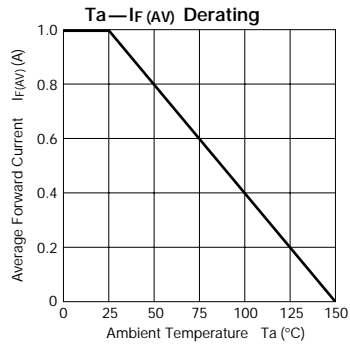

EM01 series

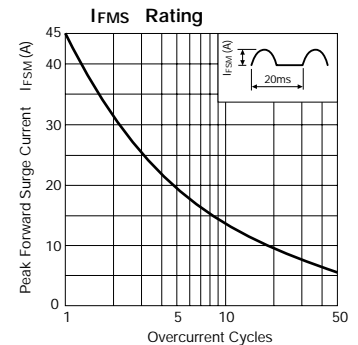
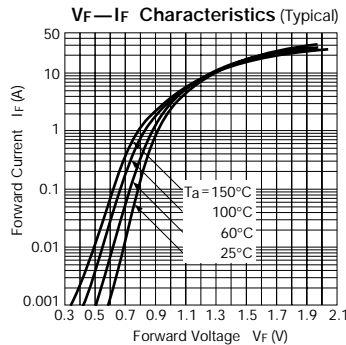
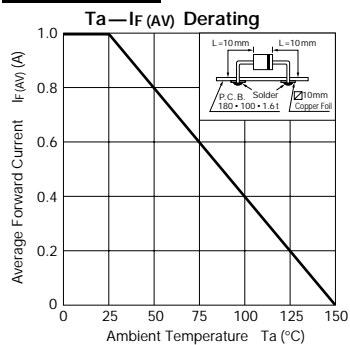

EM 1 series

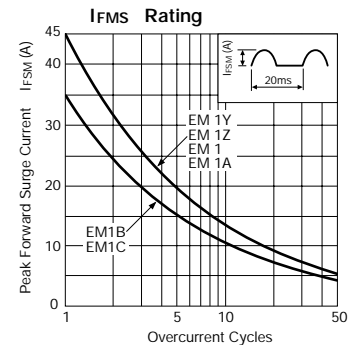
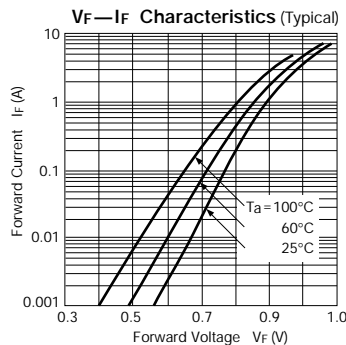
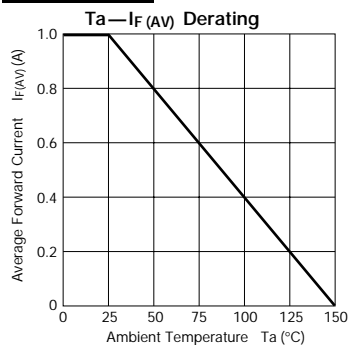

Characteristic Curves Rectifier Diodes

EM 2 series

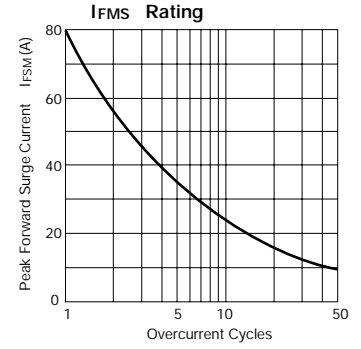
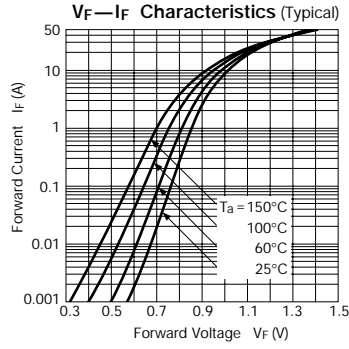
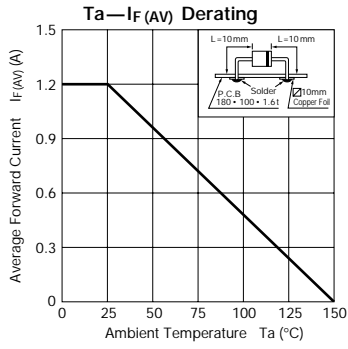

RM 1 series

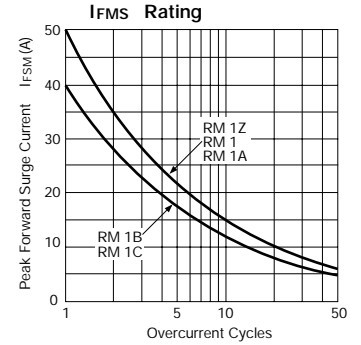
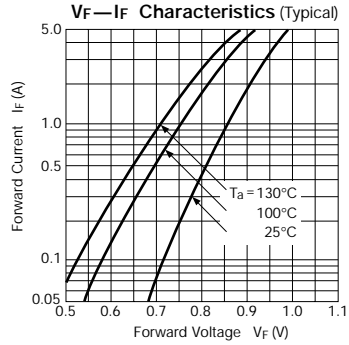
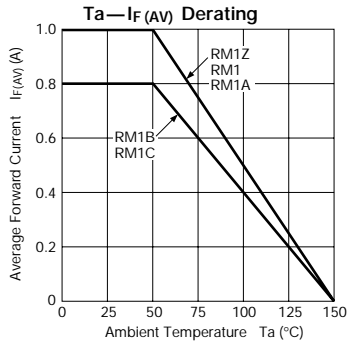

RM 11 series

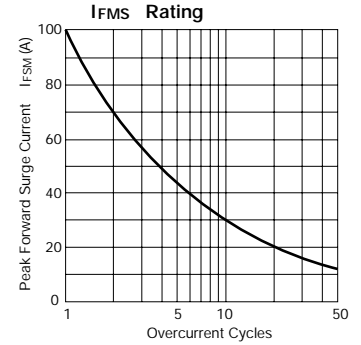
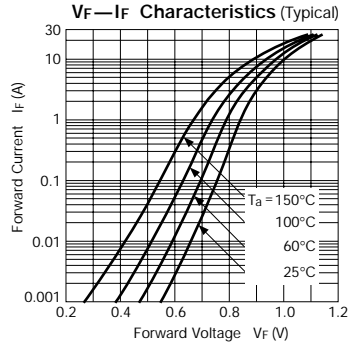
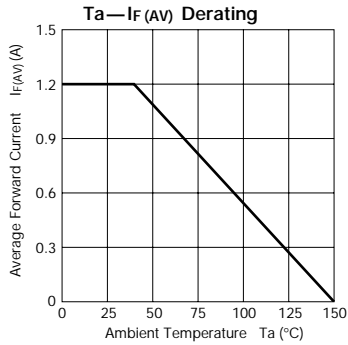

RM 10 series

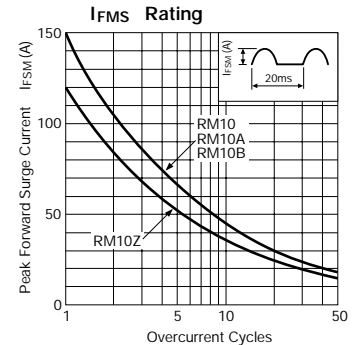
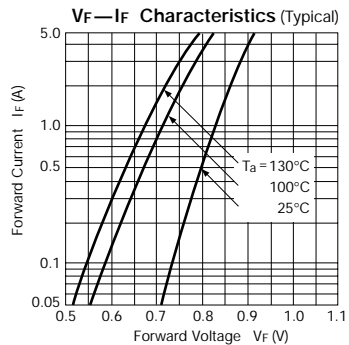
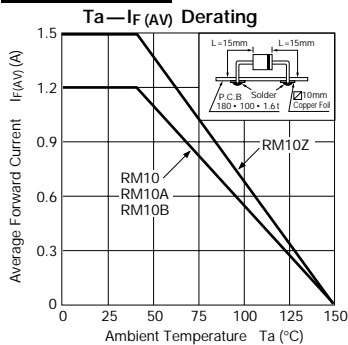

RM 2 series

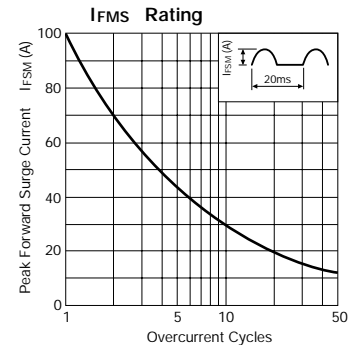
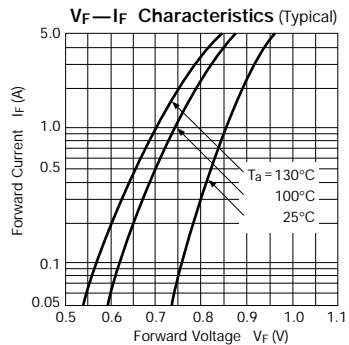
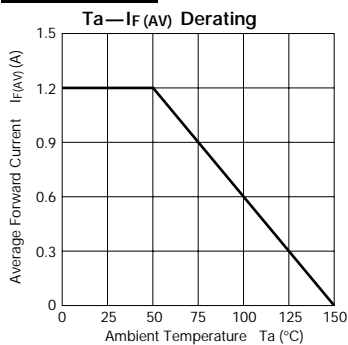

Characteristic Curves Rectifier Diodes

RO 2 series

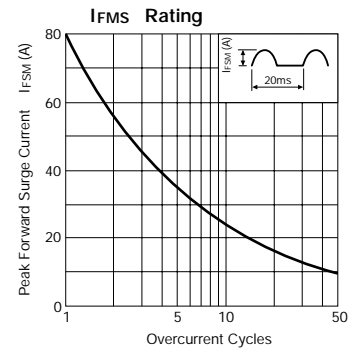
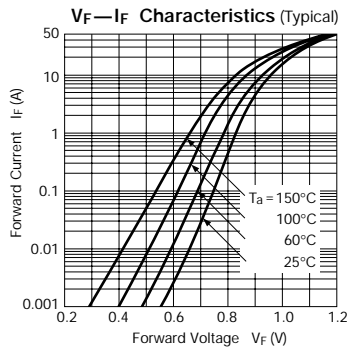
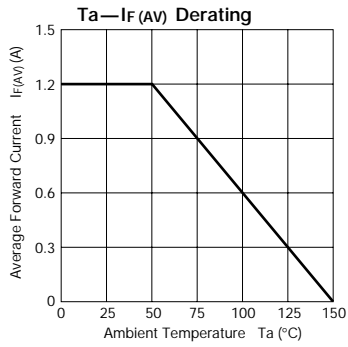

RM 3 series

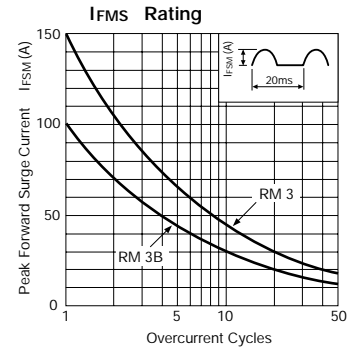
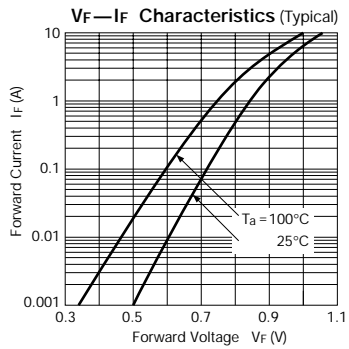
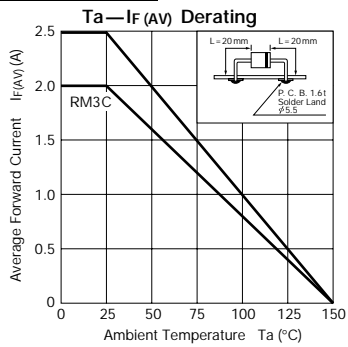

RM 4 series

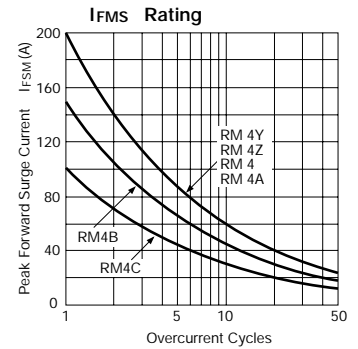
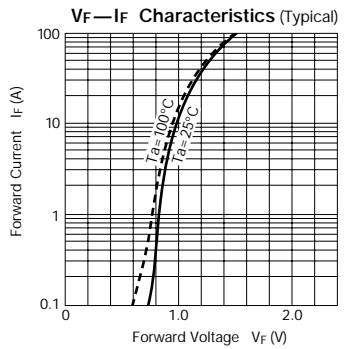
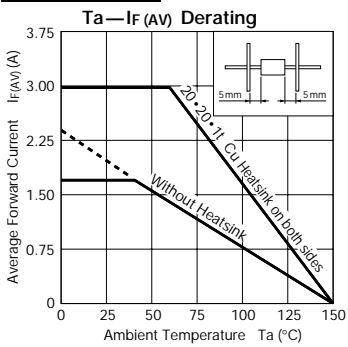

RM 4M series

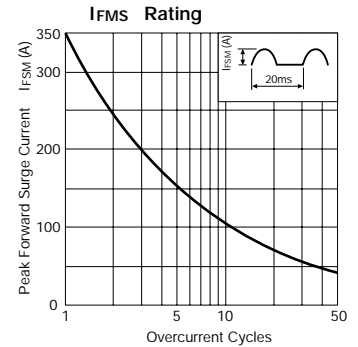
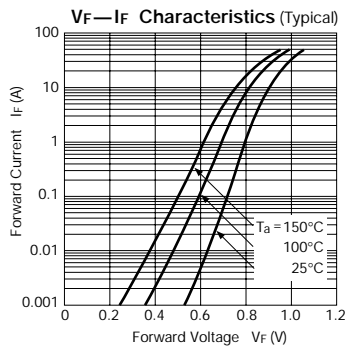
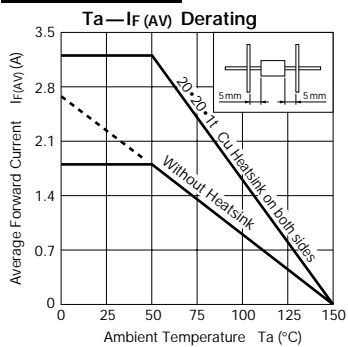

FMM-2 series

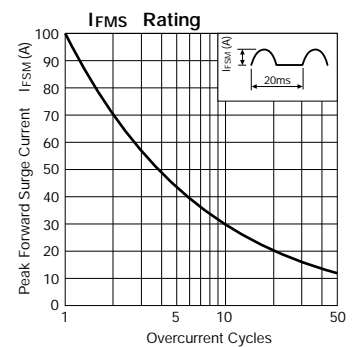
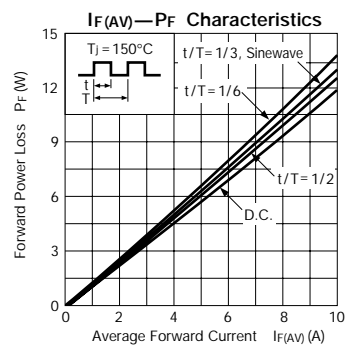
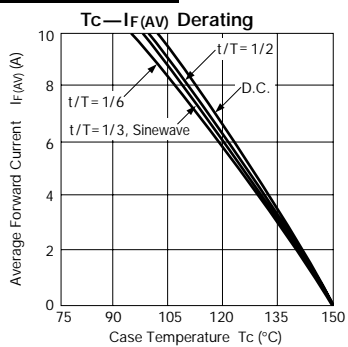

Characteristic Curves Rectifier Diodes

FMM-3 series

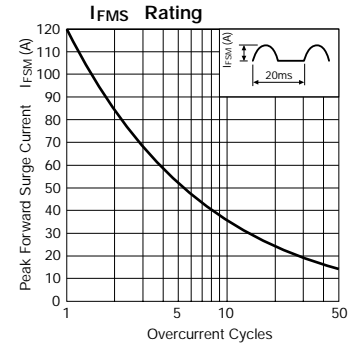
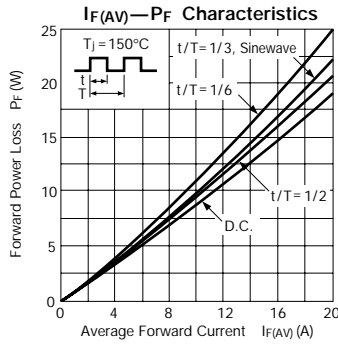
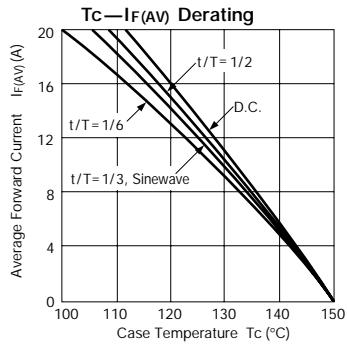

RBV-401, 402

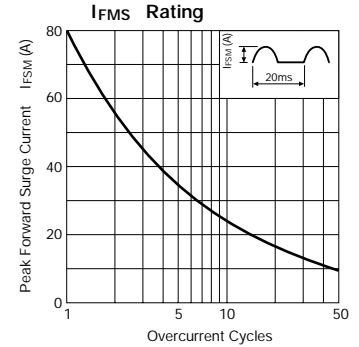
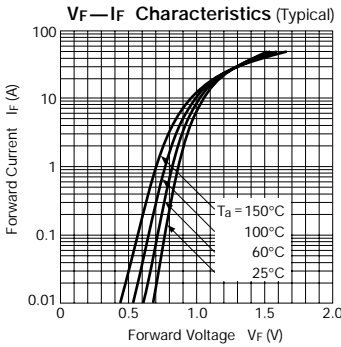
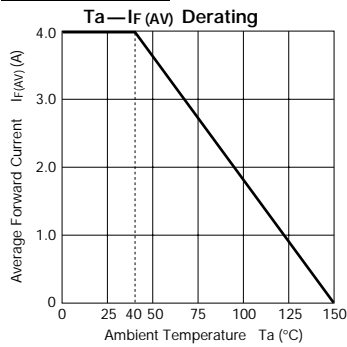

RBV-404, 406

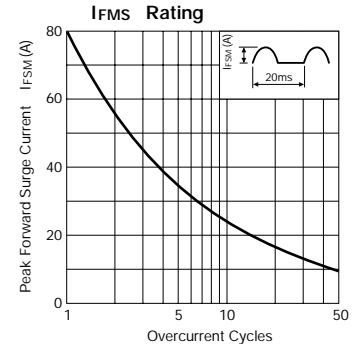
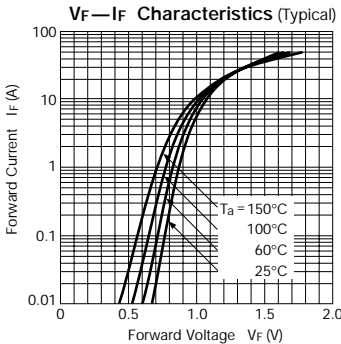
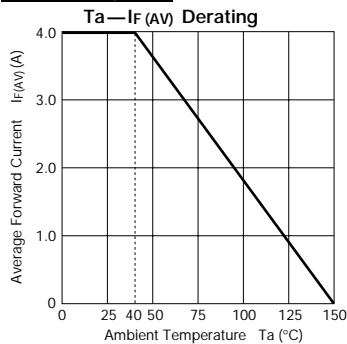

RBV-408, 40C

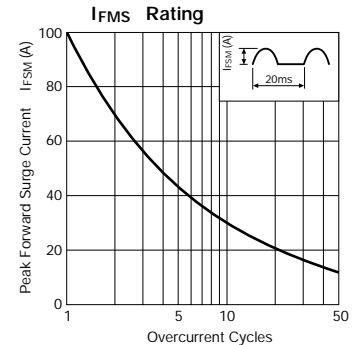
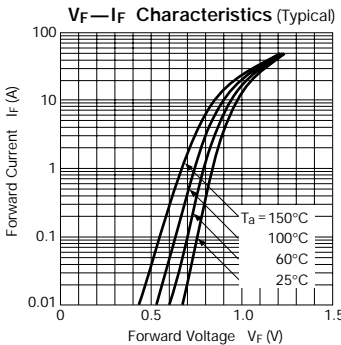
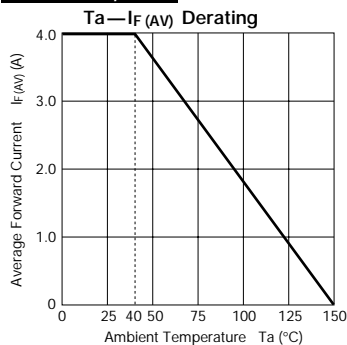

RBV-406M

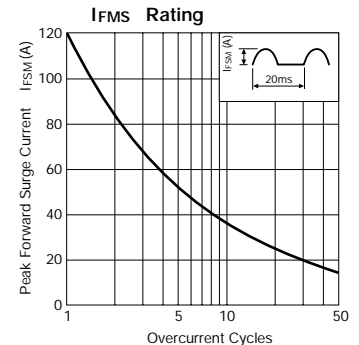
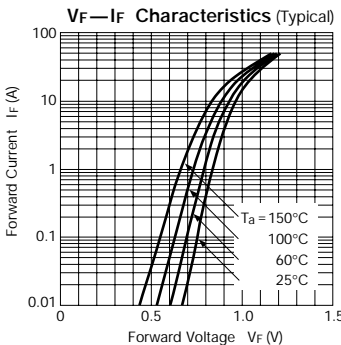
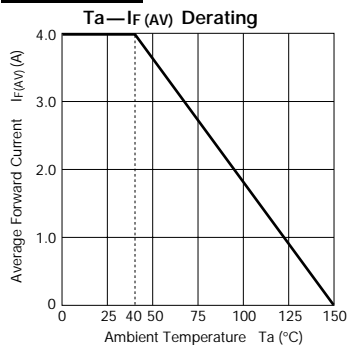

Characteristic Curves Rectifier Diodes

RBV-406H

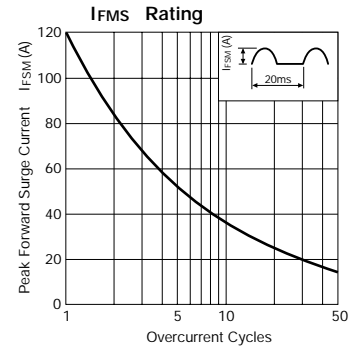
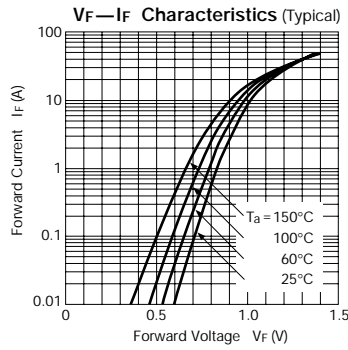
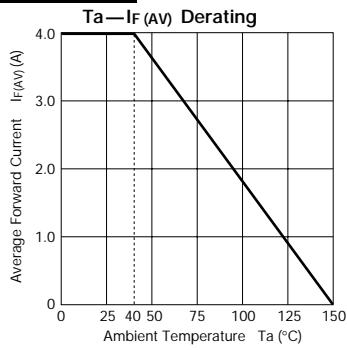

RBV-601, 602

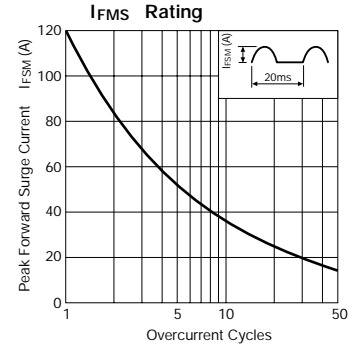
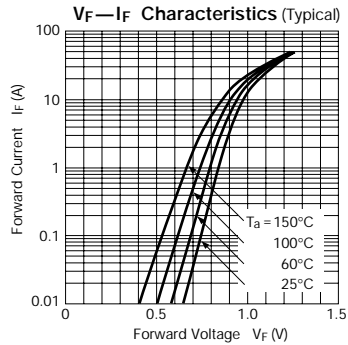
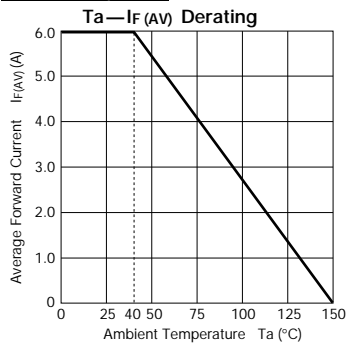

RBV-604, 606

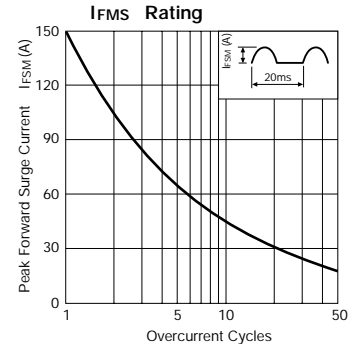
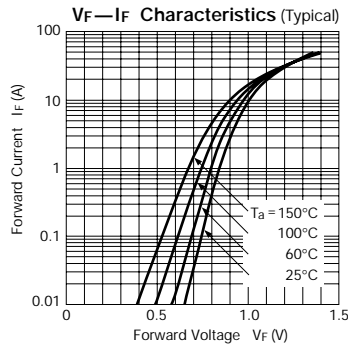
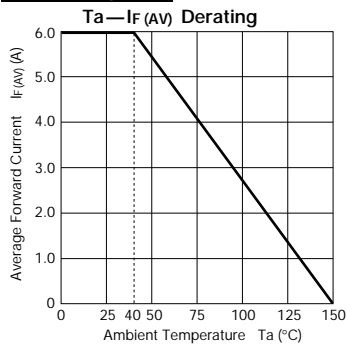

RBV-608

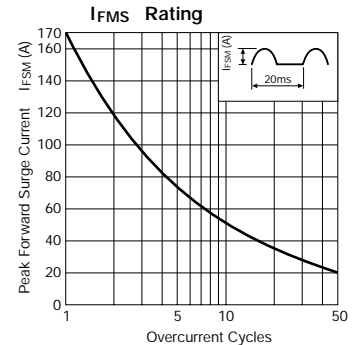
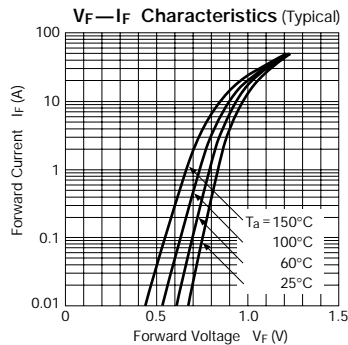
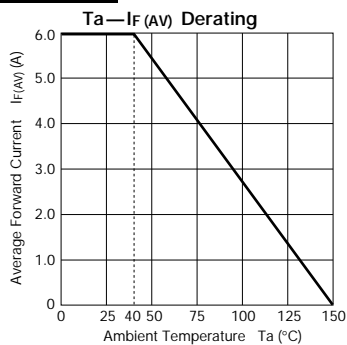

RBV-606H

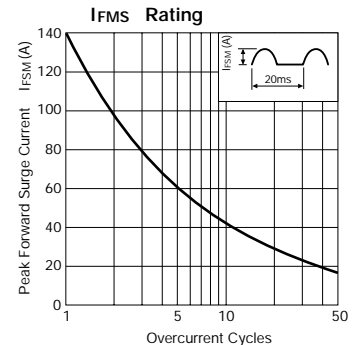
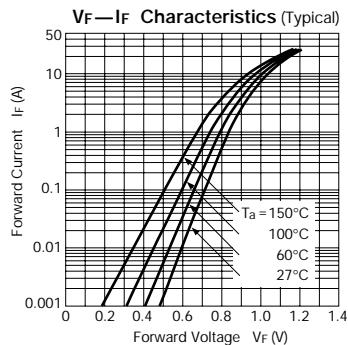
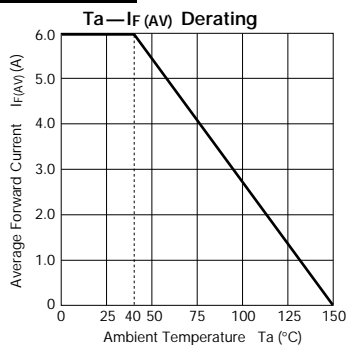

Characteristic Curves Rectifier Diodes

RBV-4106M

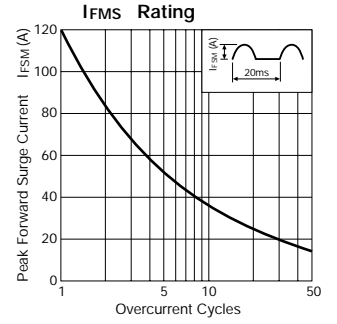
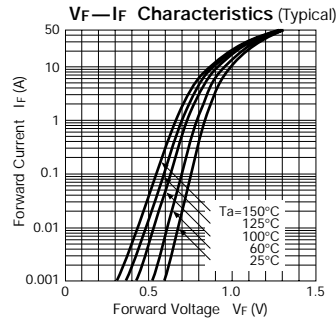
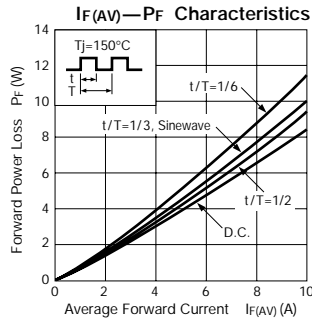
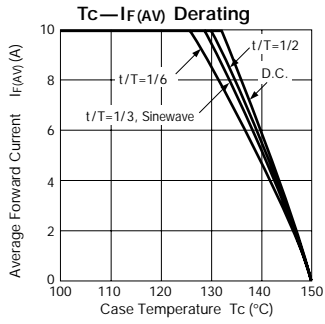

RBV-1306

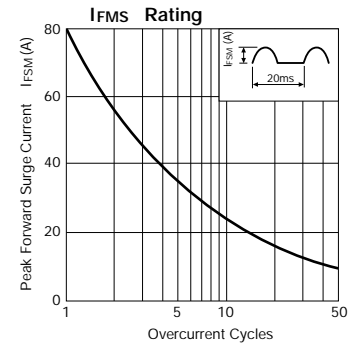
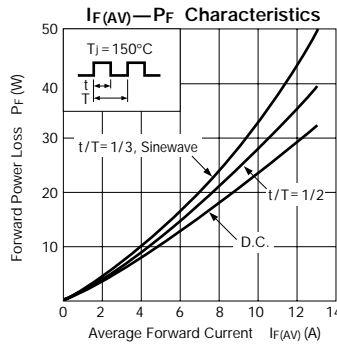
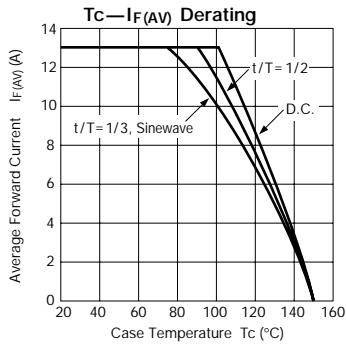

RBV-1506S

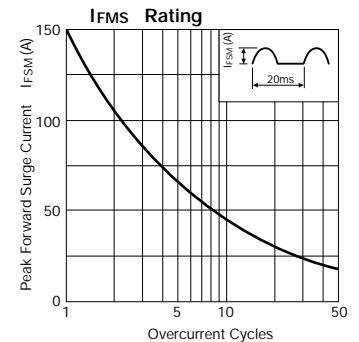
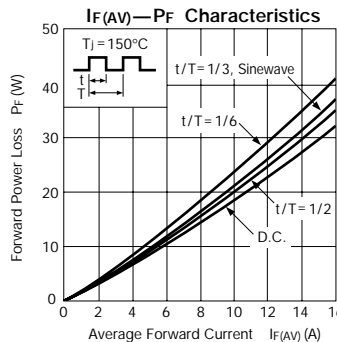
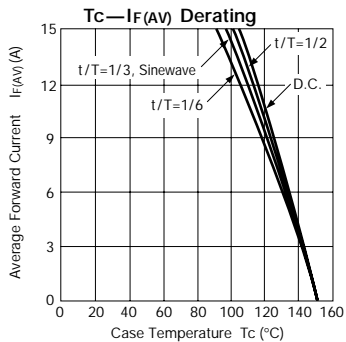

RBV-1506J

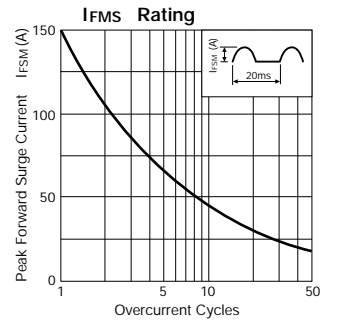
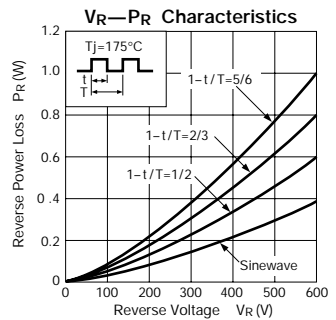
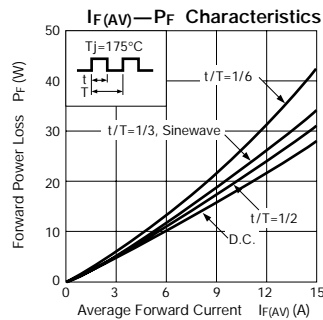
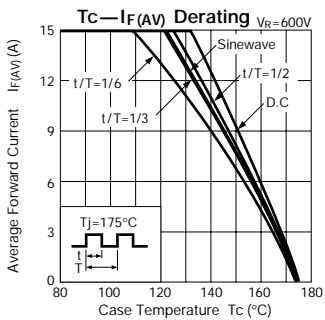

RBV-1506

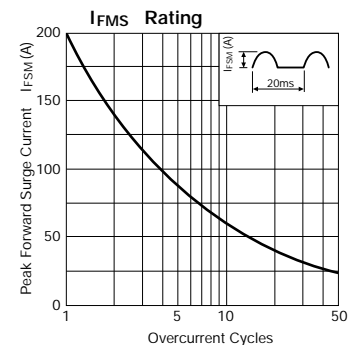
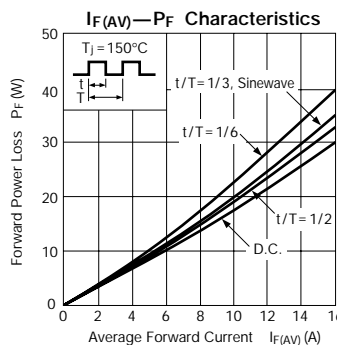
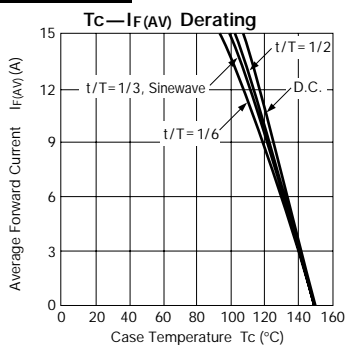

Characteristic Curves Rectifier Diodes

RBV-2506

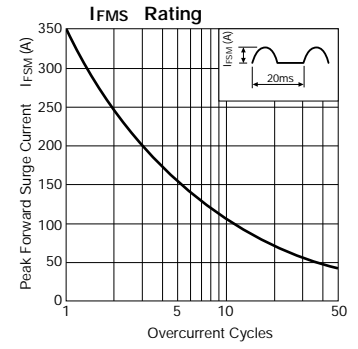
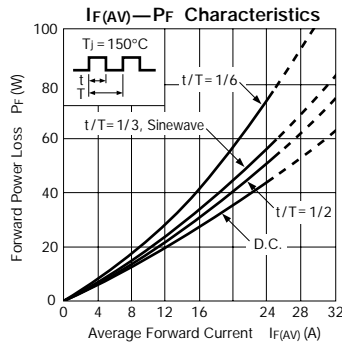
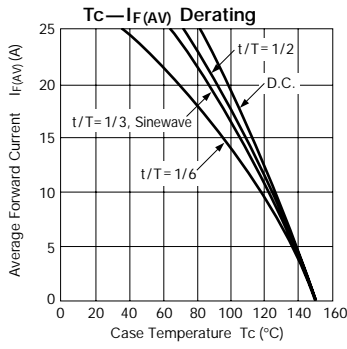

RBV-150C Under development

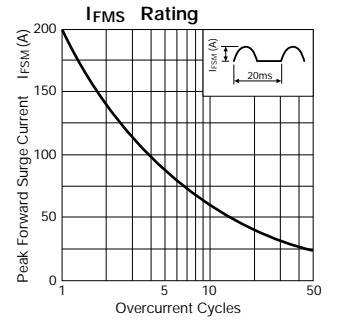
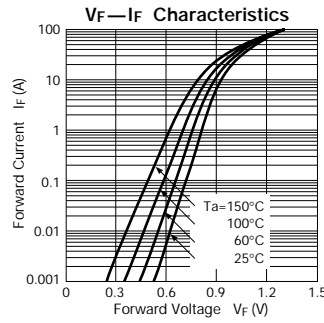
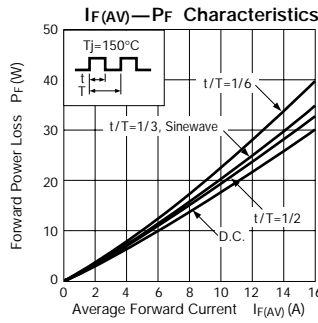
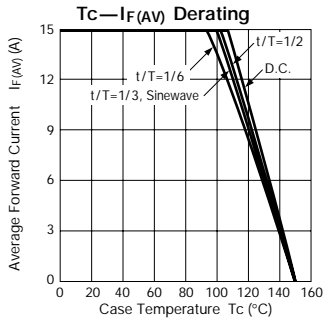

SFPM-74

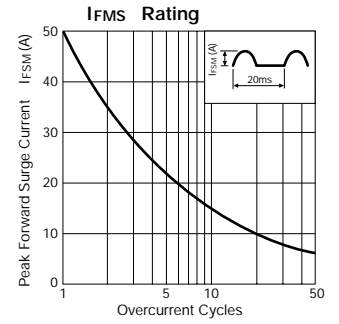
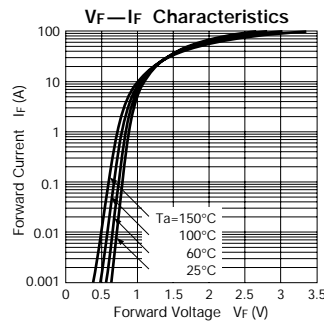
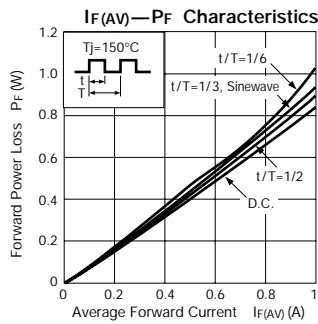
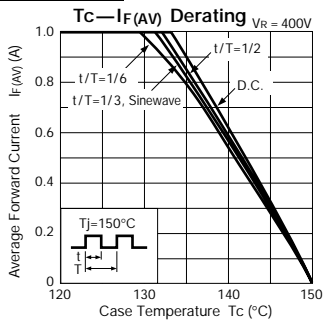

RBV-4086H

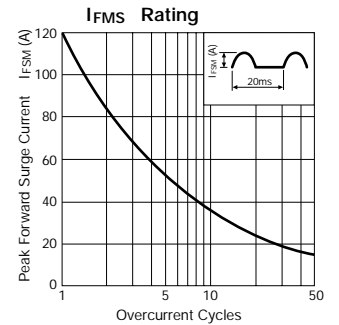
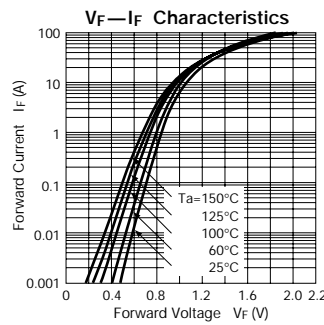
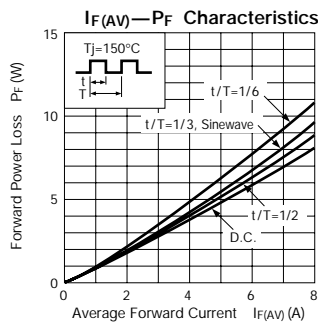
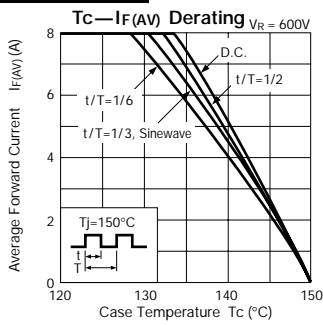

Fast-Recovery Rectifier Diodes

AS01 series

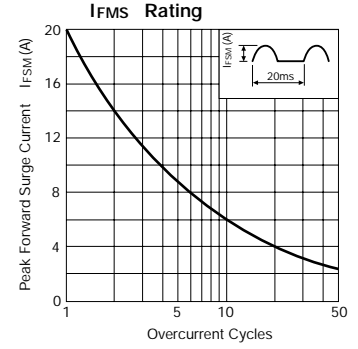
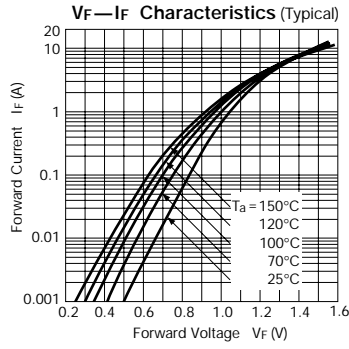
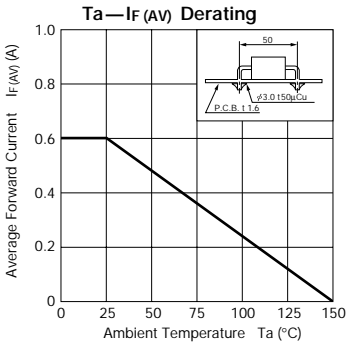

AU01 series

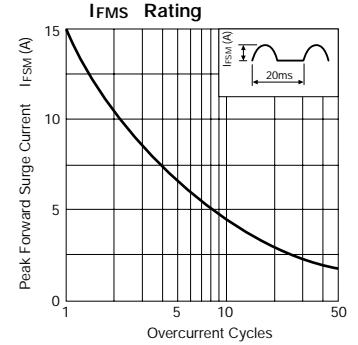
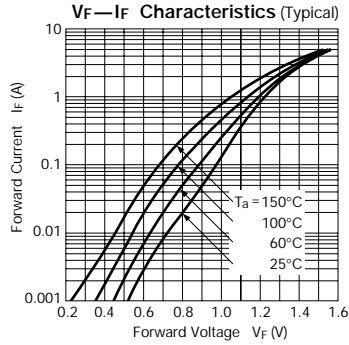
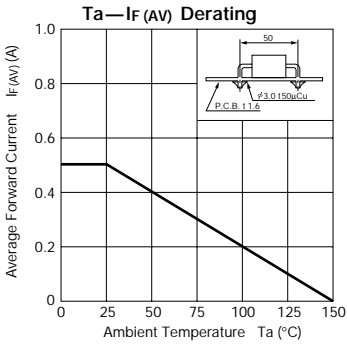

AU02 series

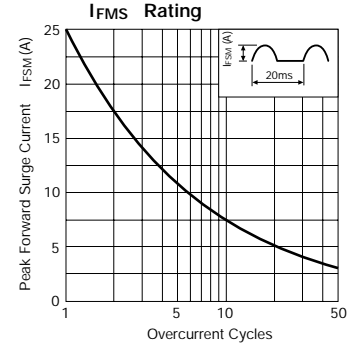
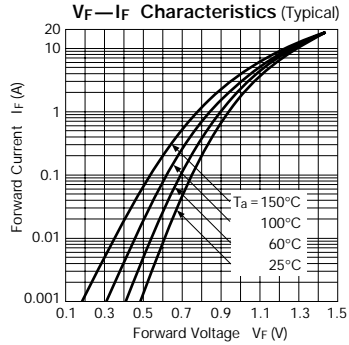
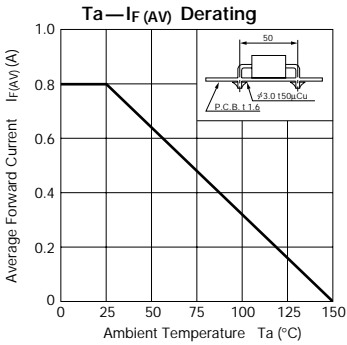

ES01 series

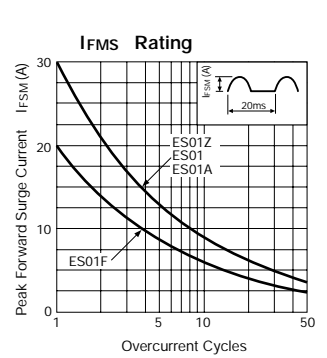
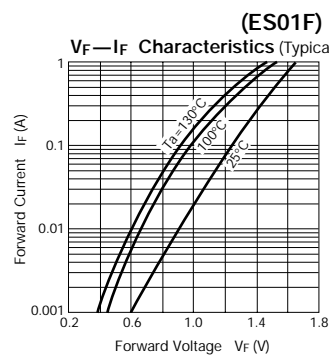
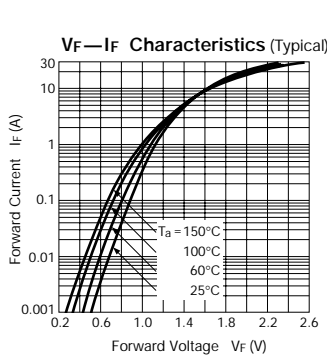
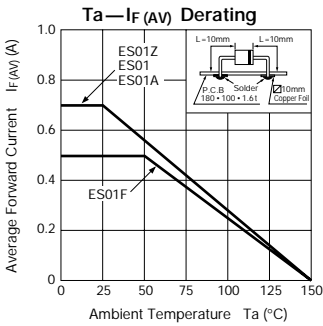

EU01 series

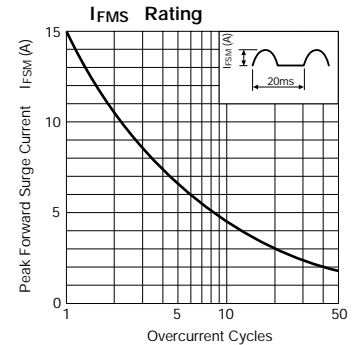
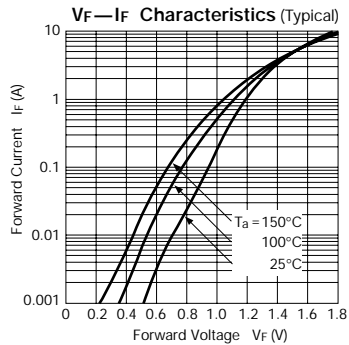
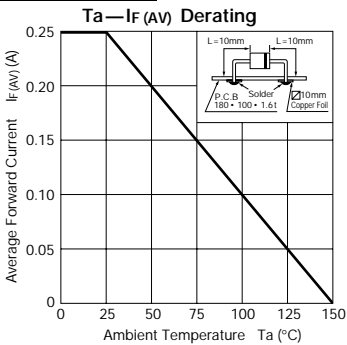

Fast-Recovery Rectifier Diodes

EU02 series

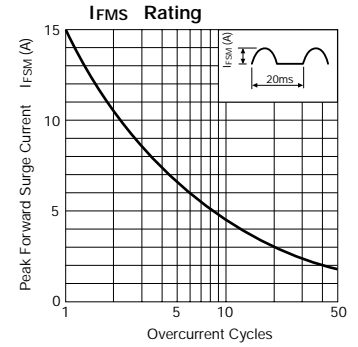
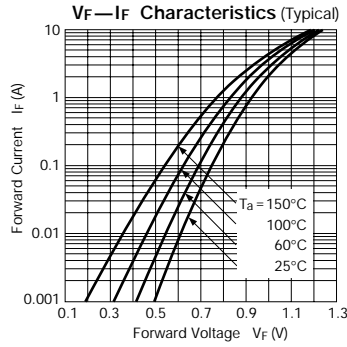
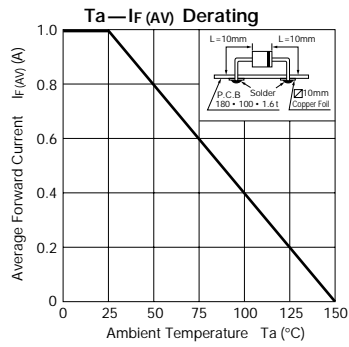

EH 1 series

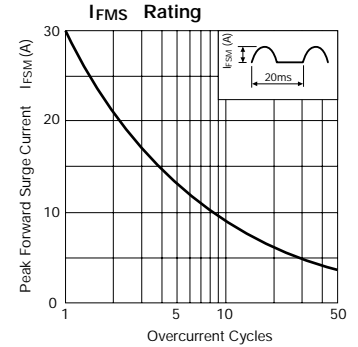
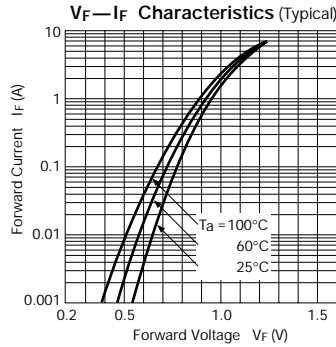
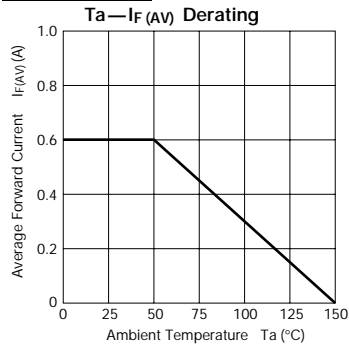

ES 1 series

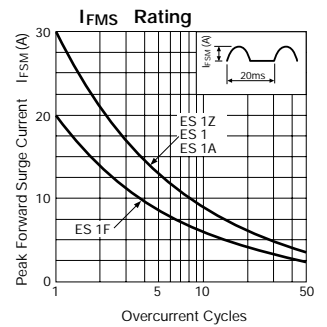
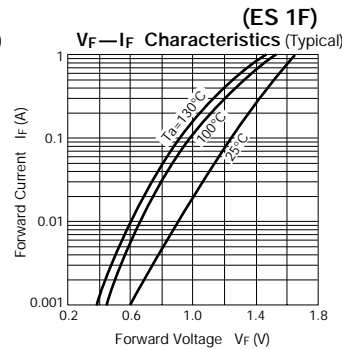
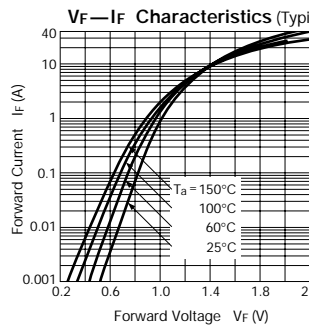
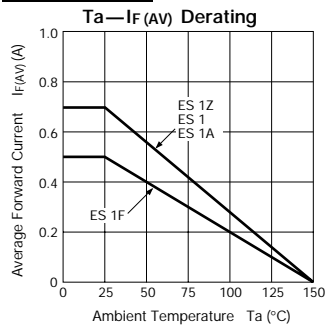

EU 1 series

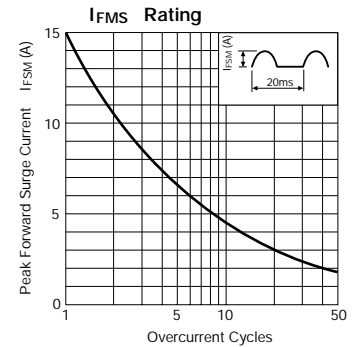
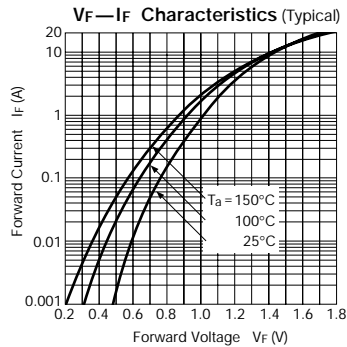
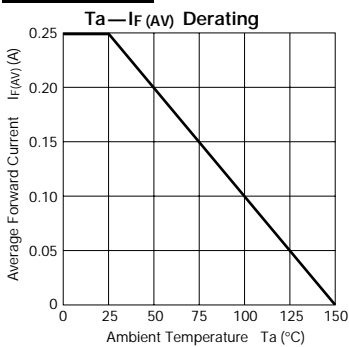

EU 2 series

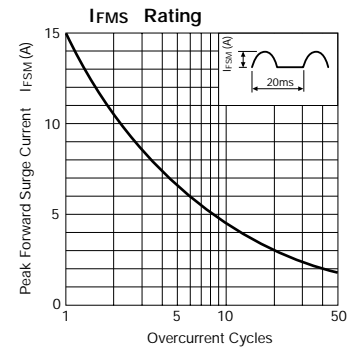
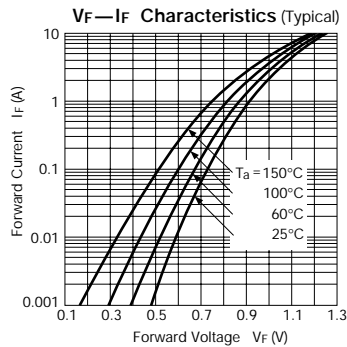
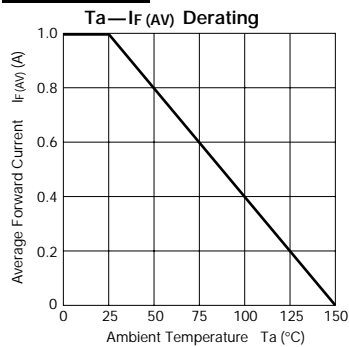

Fast-Recovery Rectifier Diodes

EU 2YX

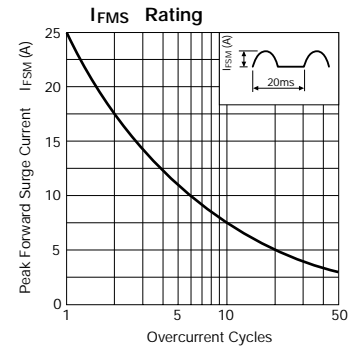
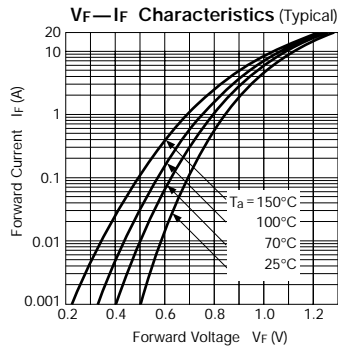
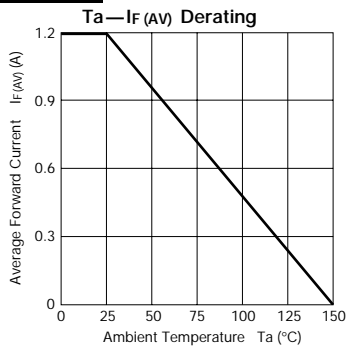

RC 2

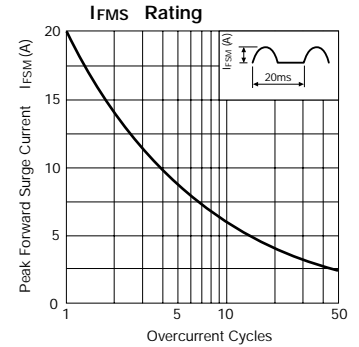
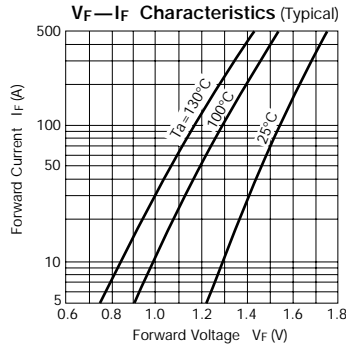
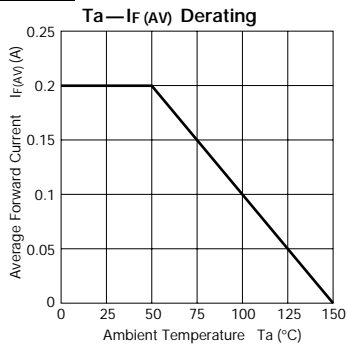

RF 1 series

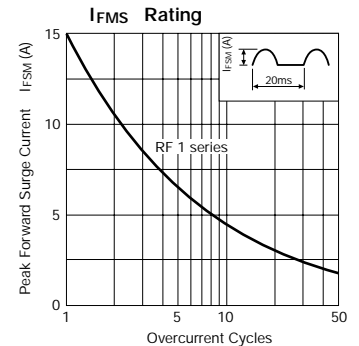
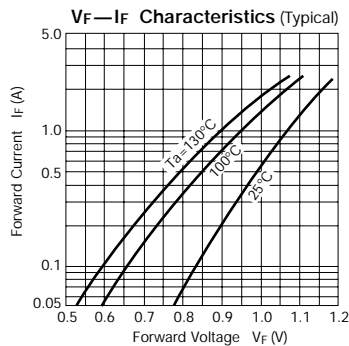
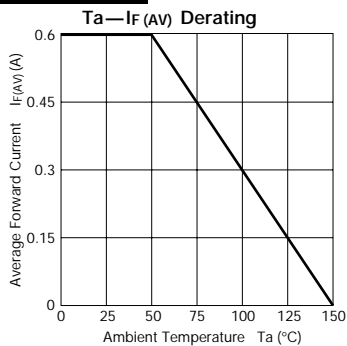

RH 1 series

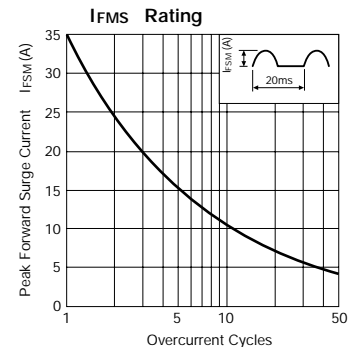
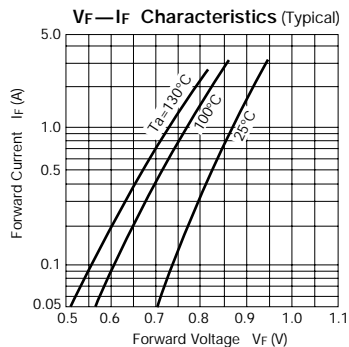
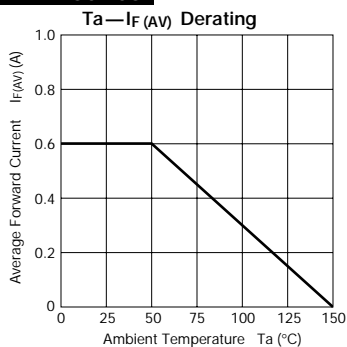

RS 1 series

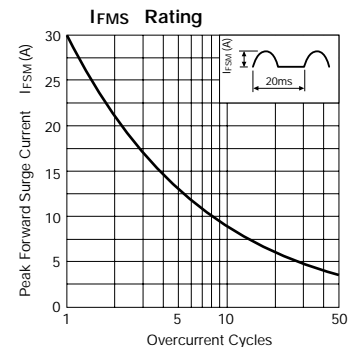
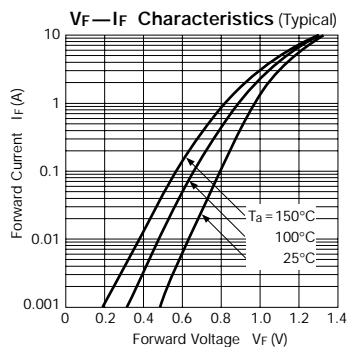
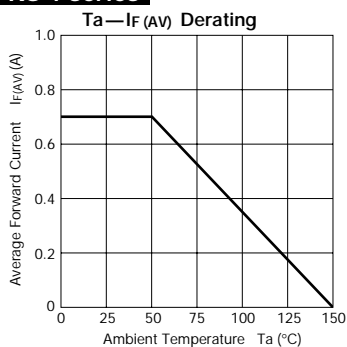

Fast-Recovery Rectifier Diodes

RU 1 series

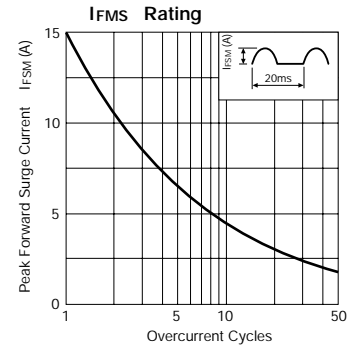
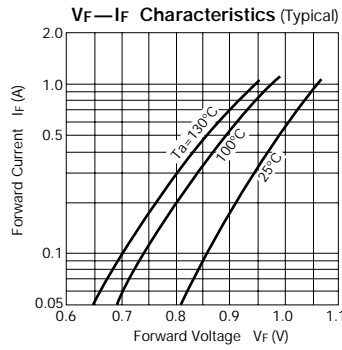
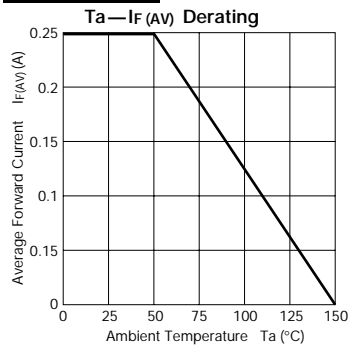

RU 2 series

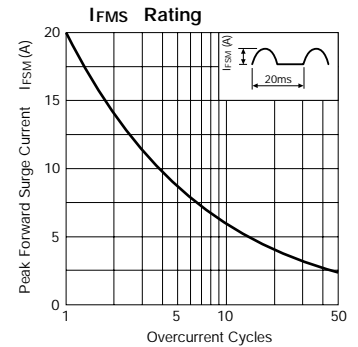
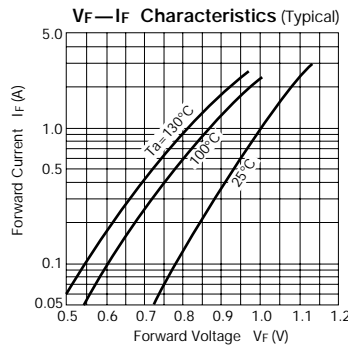
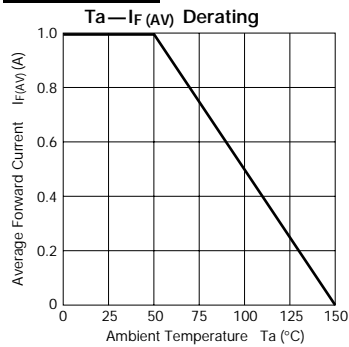

RU 2YX

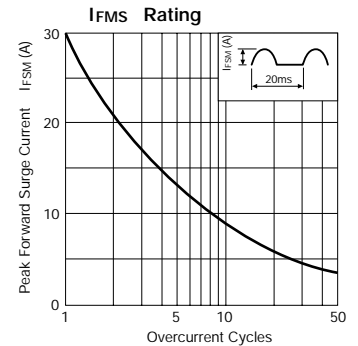
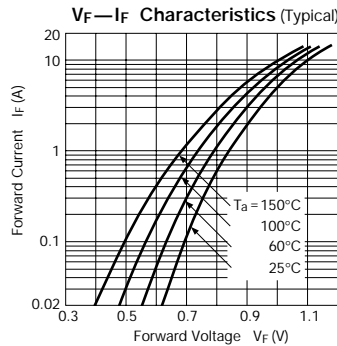
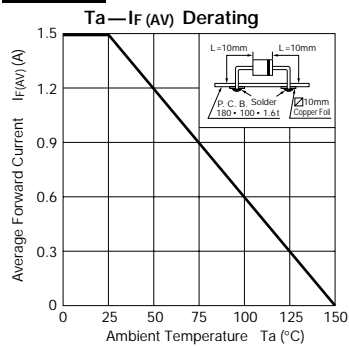

RU 2M series

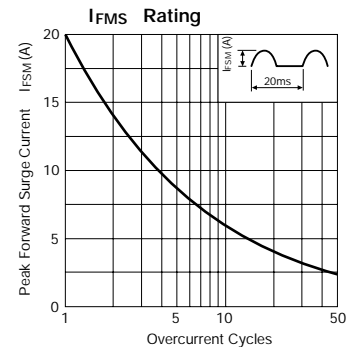
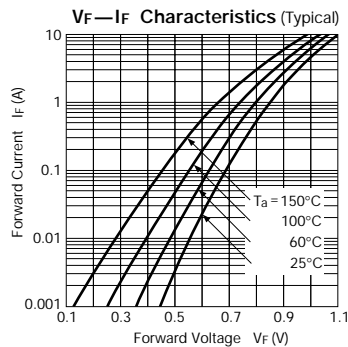
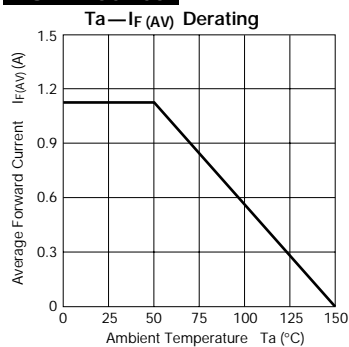

RU 20A

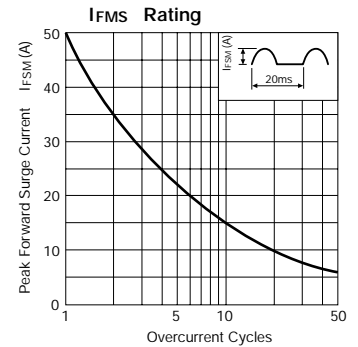
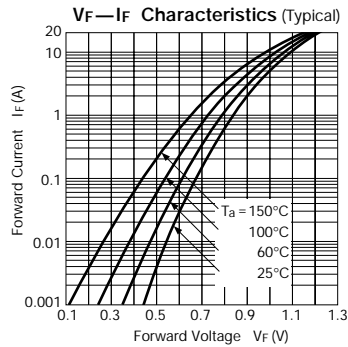
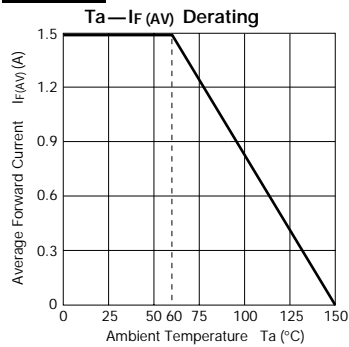

Characteristic Curves

Fast-Recovery Rectifier Diodes

RU 3 series

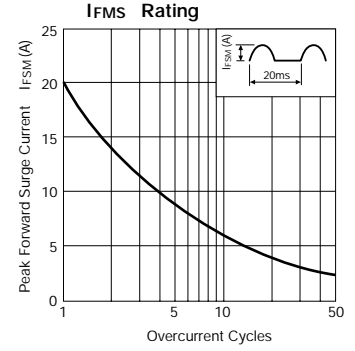
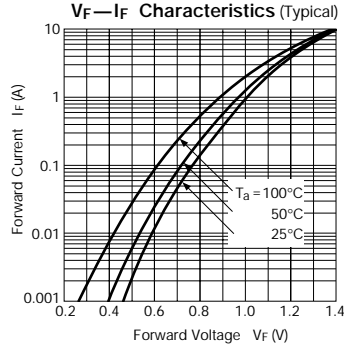
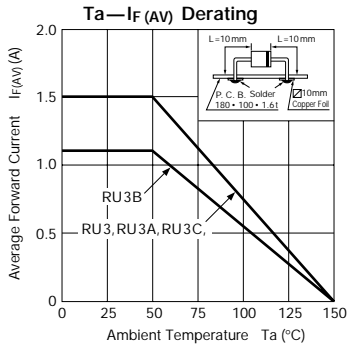

RU 3YX

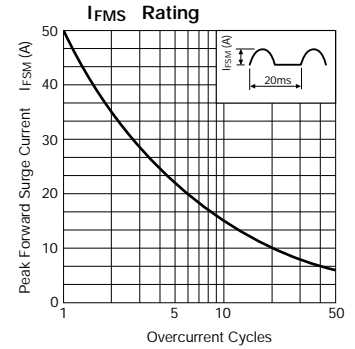
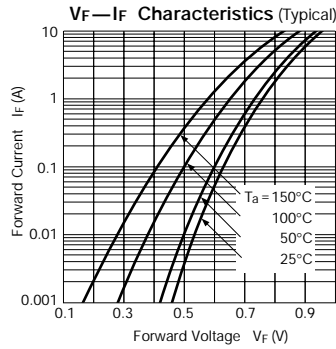
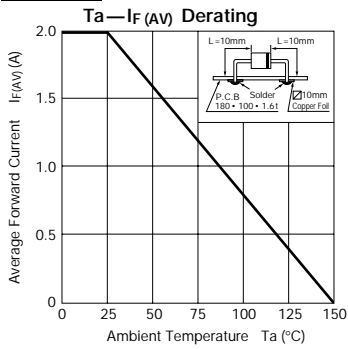

RU 3M series

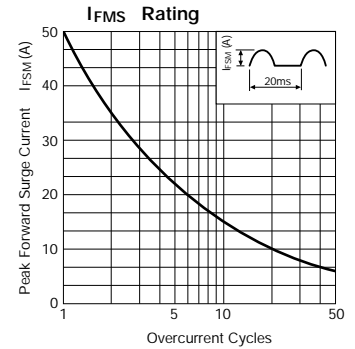
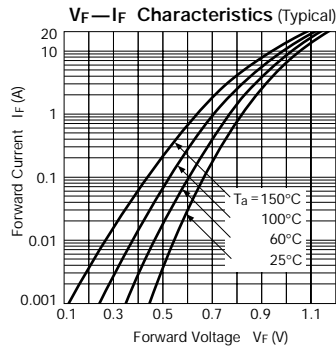
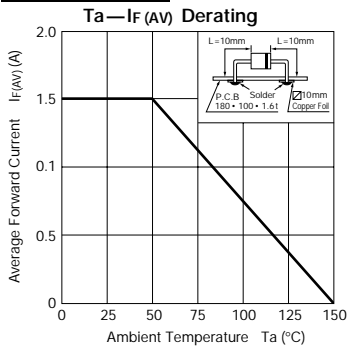

RU 30 series

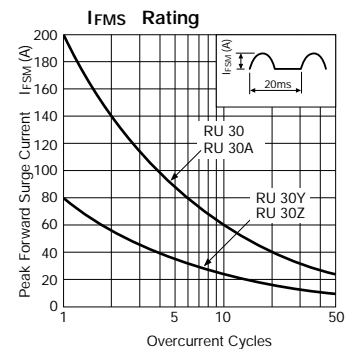
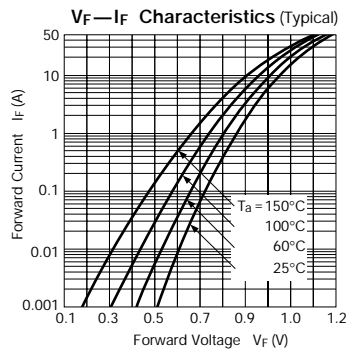
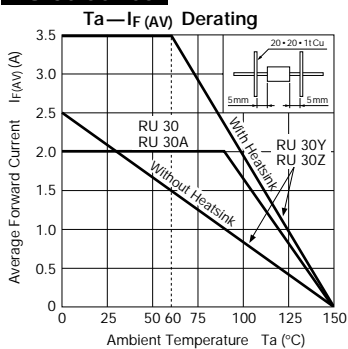

RU 31, 31A

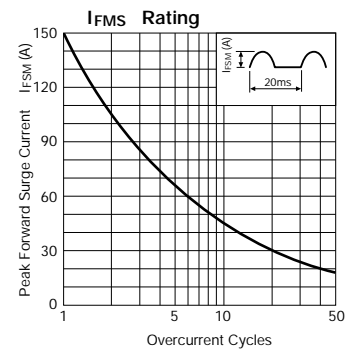
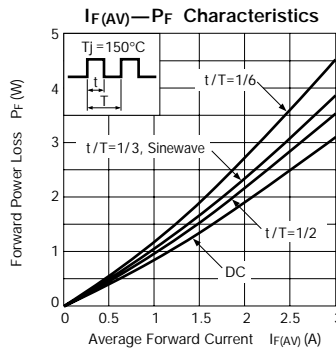
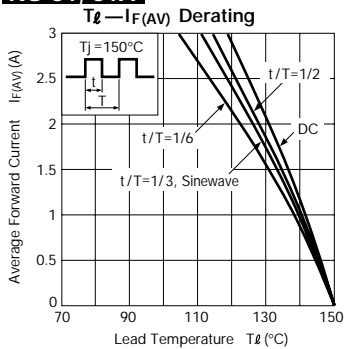

Fast-Recovery Rectifier Diodes

RU 4YX

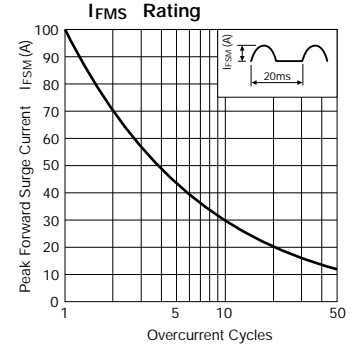
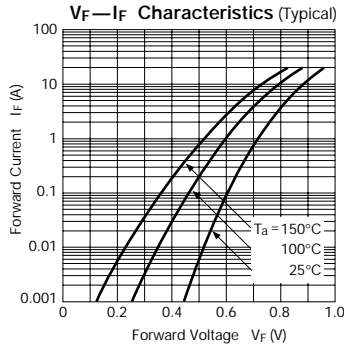
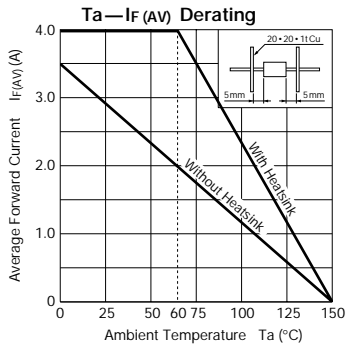

RU 4Y, 4Z

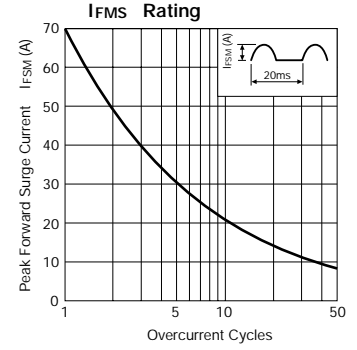
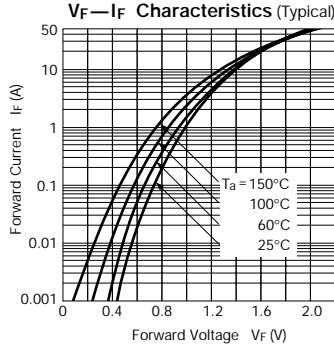
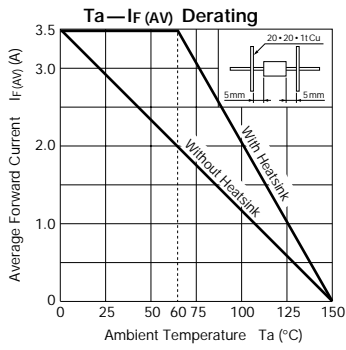

RU 4, 4A, 4B

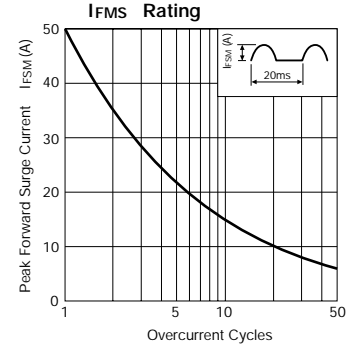
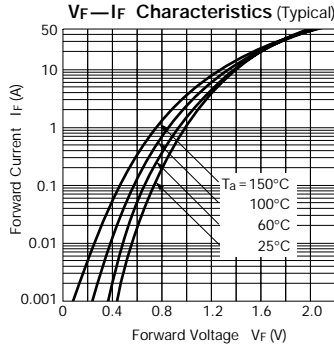
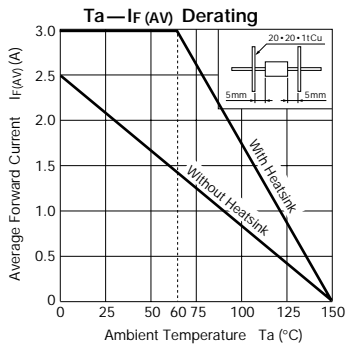

RU 4C

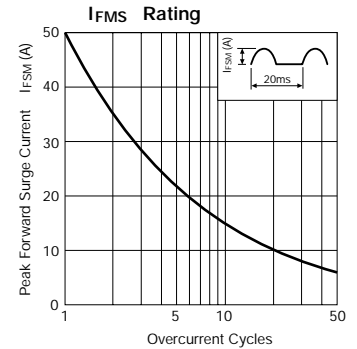
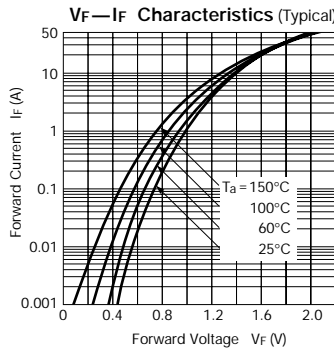
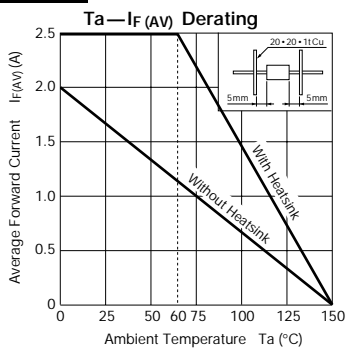

RU 4M series

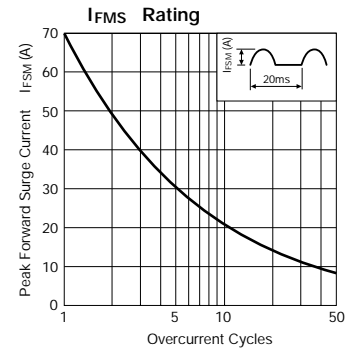
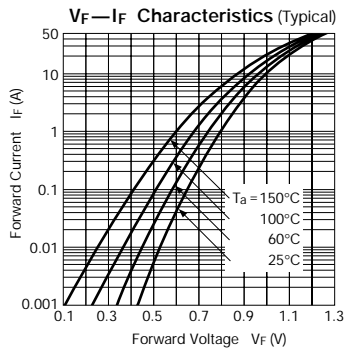
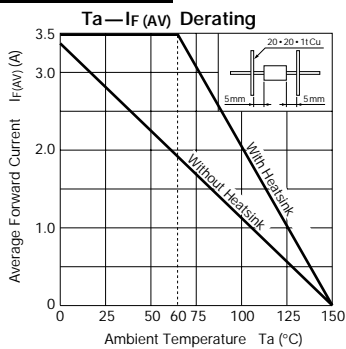

Fast-Recovery Rectifier Diodes

FMU-G2YXS

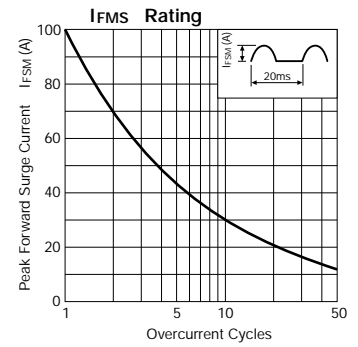
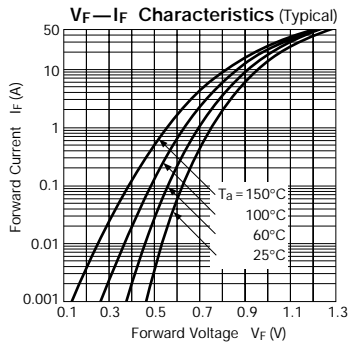
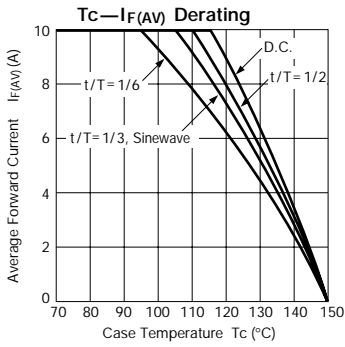

FMUP-1056

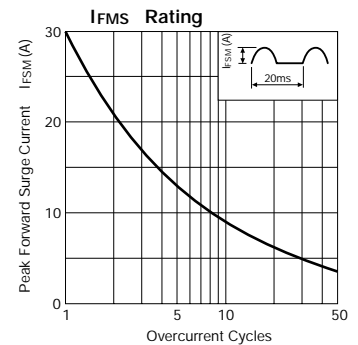
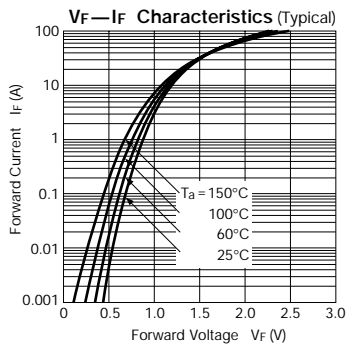
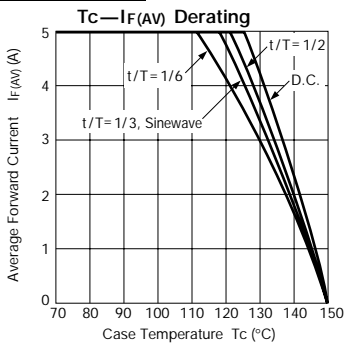

FMUP-2056 Under development

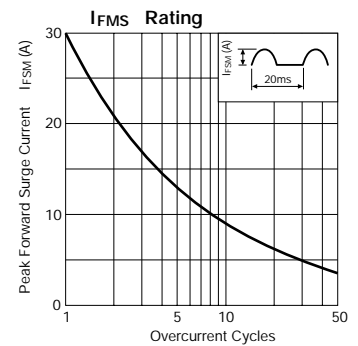
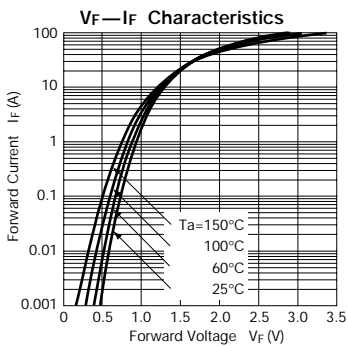
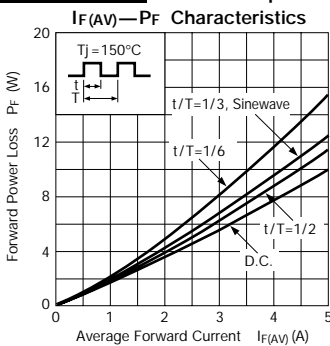

FMUP-1106

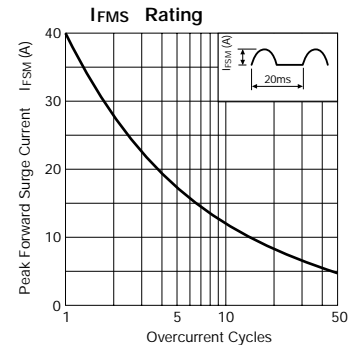
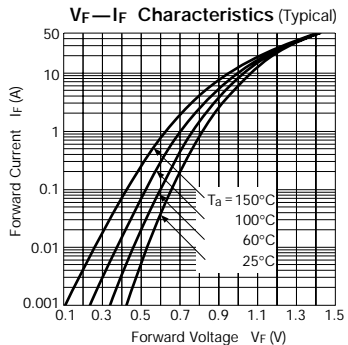
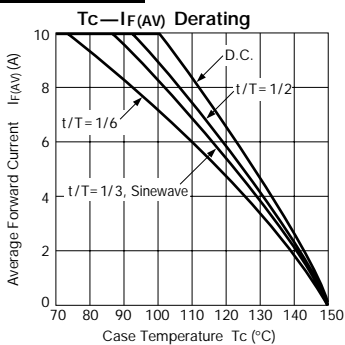

FMU-1 series

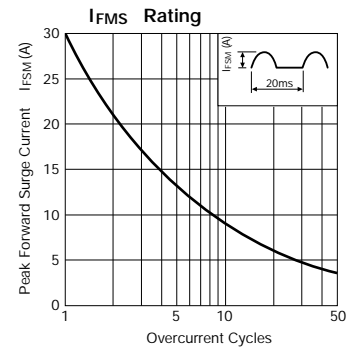
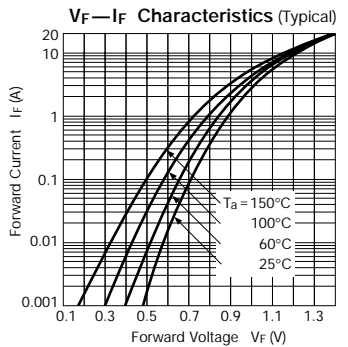
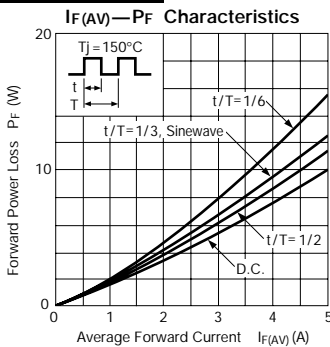

Fast-Recovery Rectifier Diodes

FMU-2 series

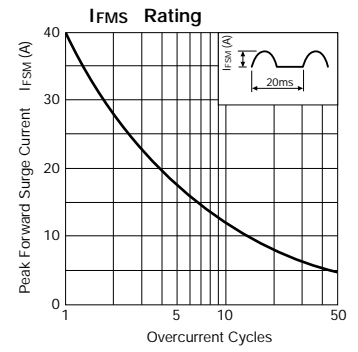
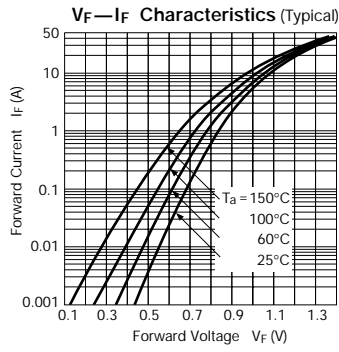
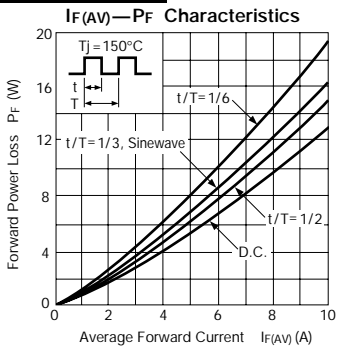

FMU-3 series

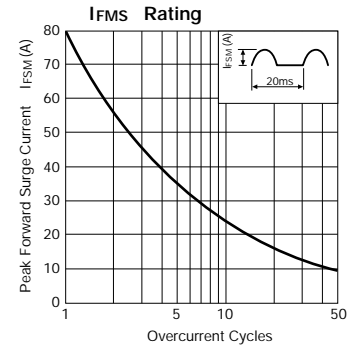
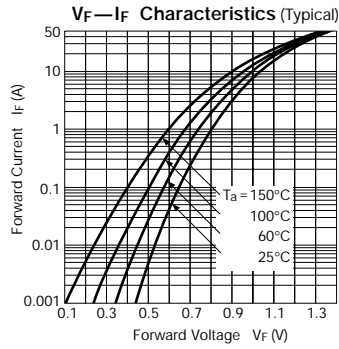
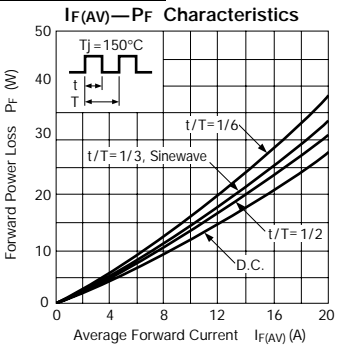

Ultra-Fast-Recovery Rectifier Diodes

AP01C

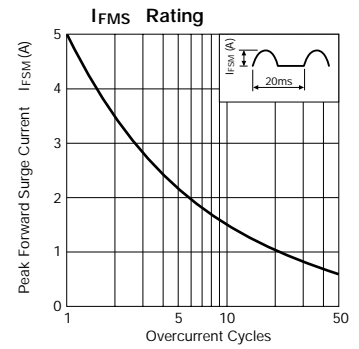
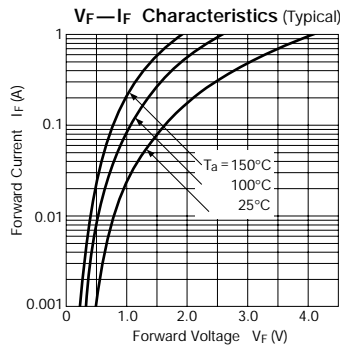
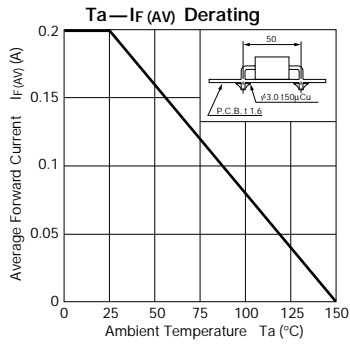

EP01C

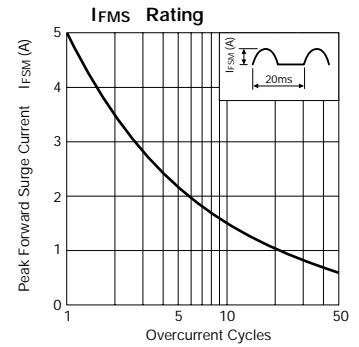
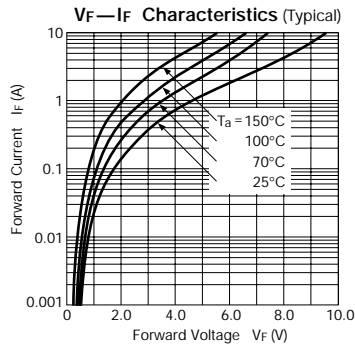
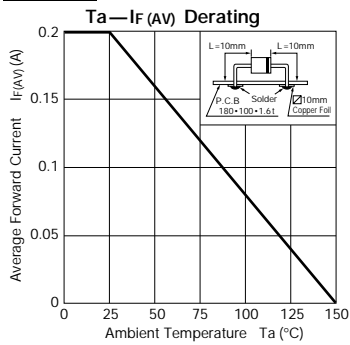

SFPL-52

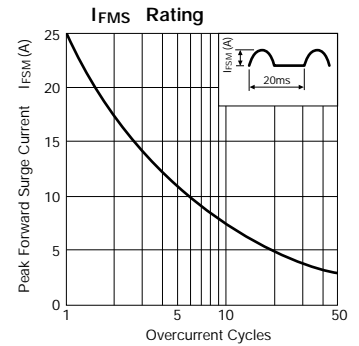
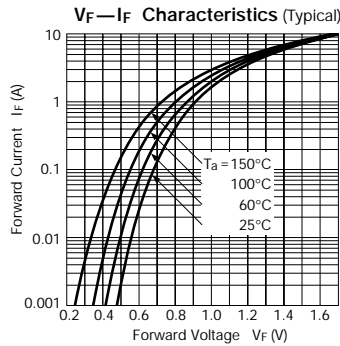
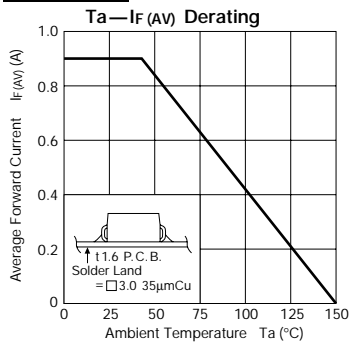

SFPL-62

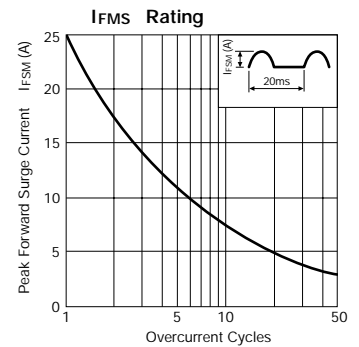
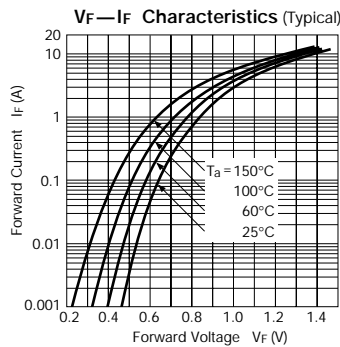
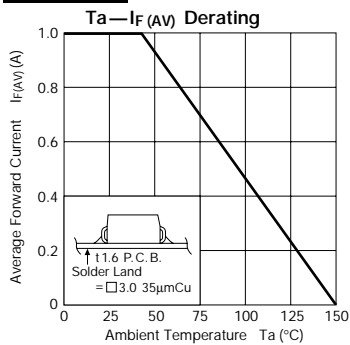

SFPX-62

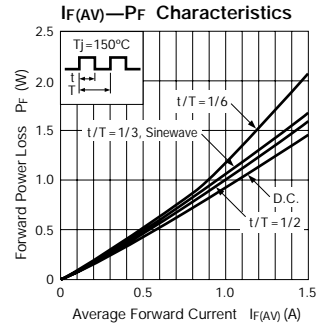
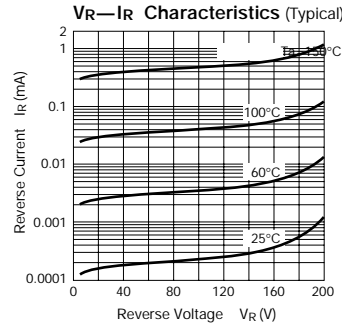
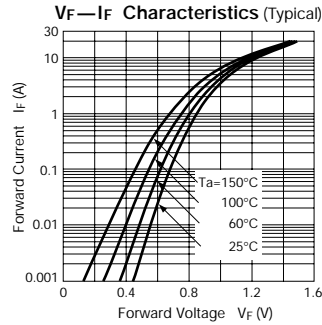
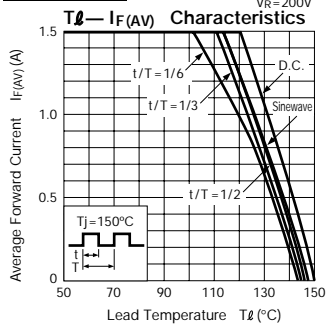

Ultra-Fast-Recovery Rectifier Diodes

SPX-G32S

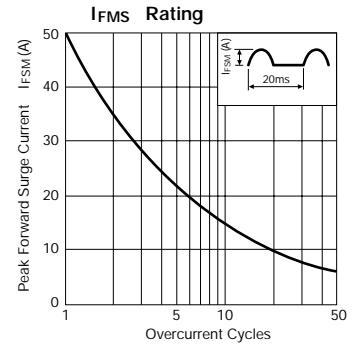
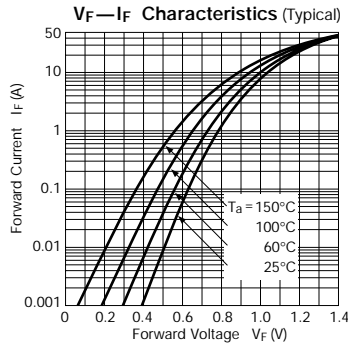
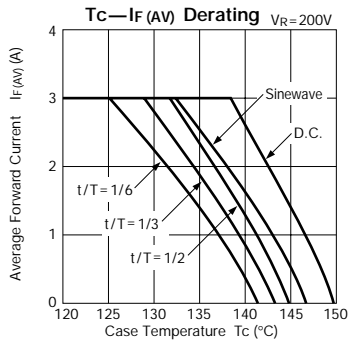

SPX-62S

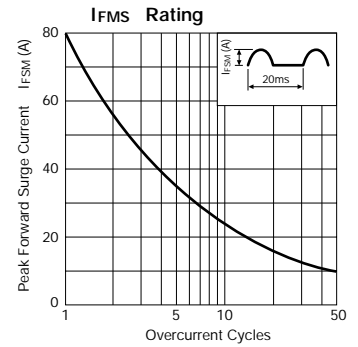
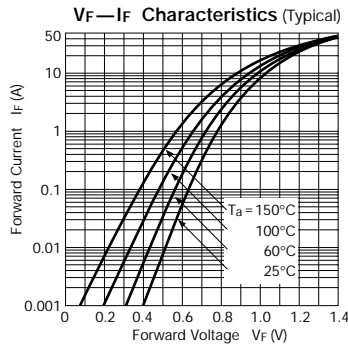
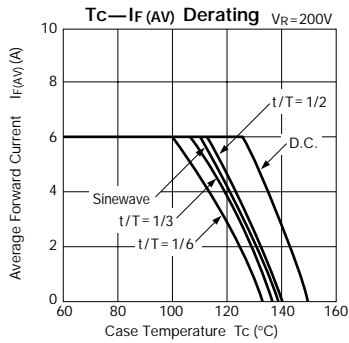

AG01 series

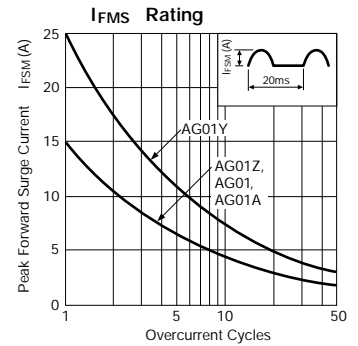
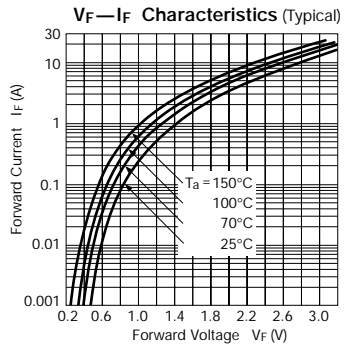
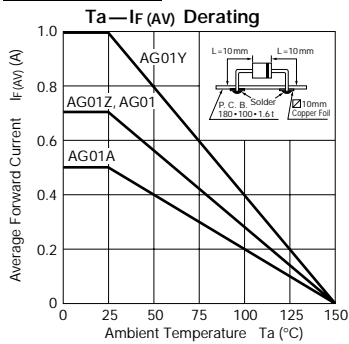

AL01Z

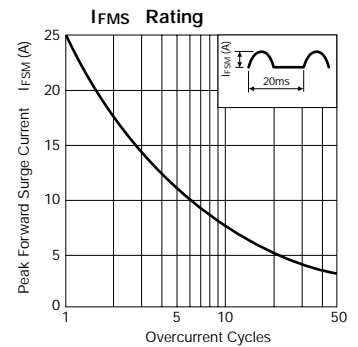
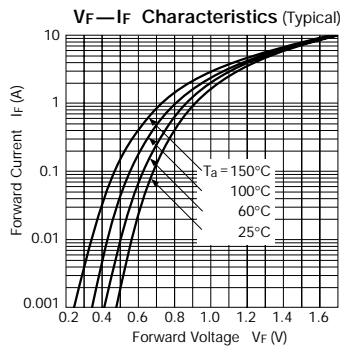
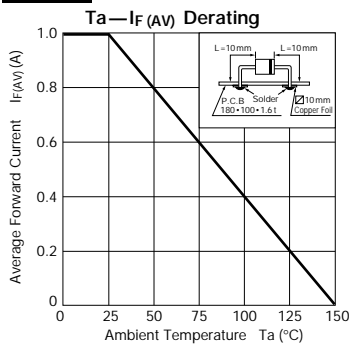

EG01Y, EG01Z, EG01

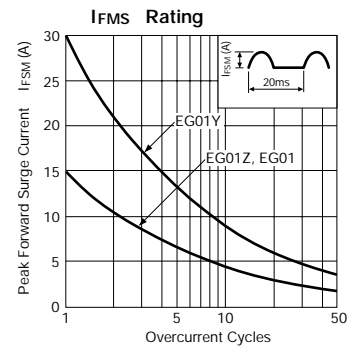
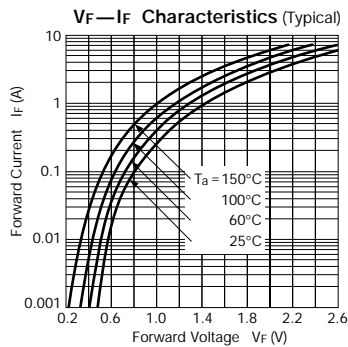
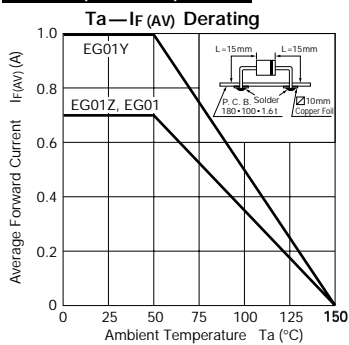

Ultra-Fast-Recovery Rectifier Diodes

EG01A

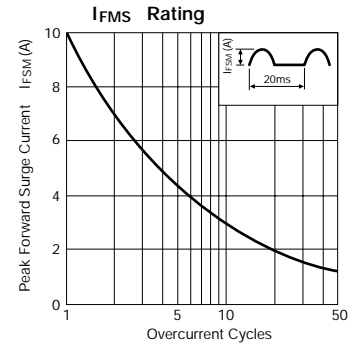
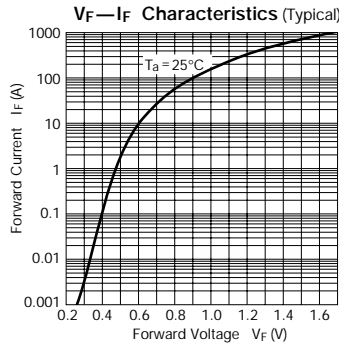
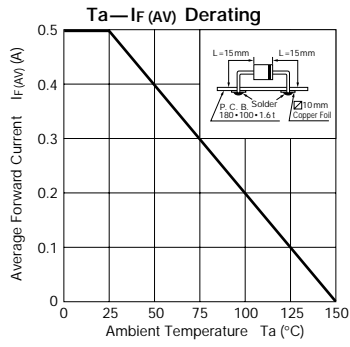

EG01C

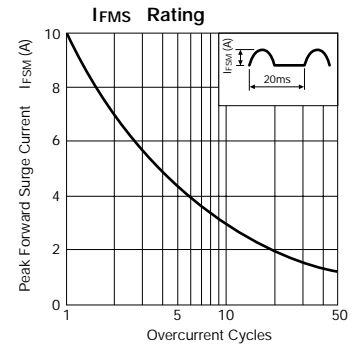
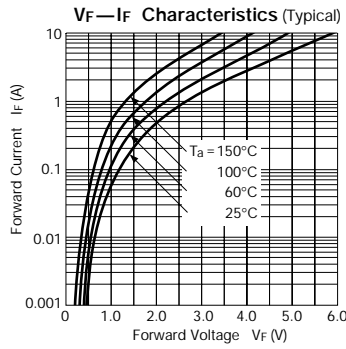
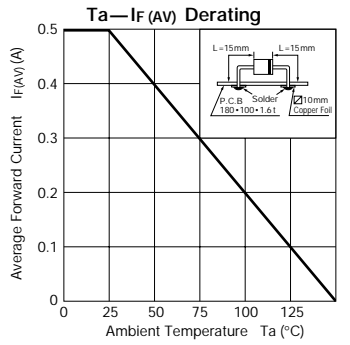

EL02Z

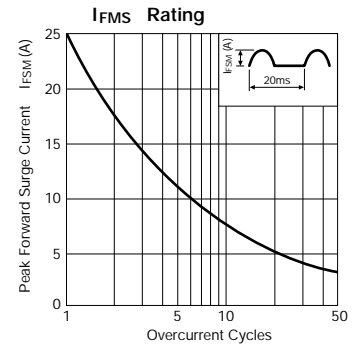
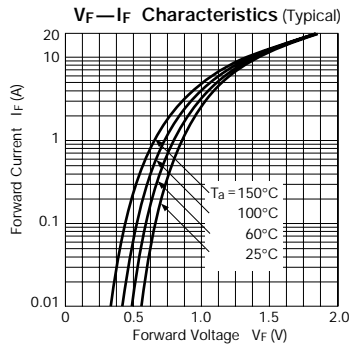
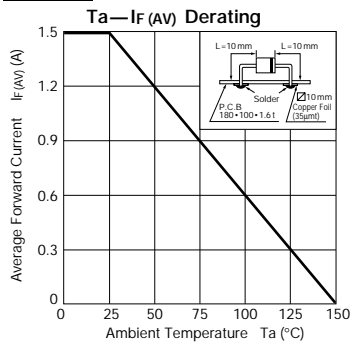

EN01Z

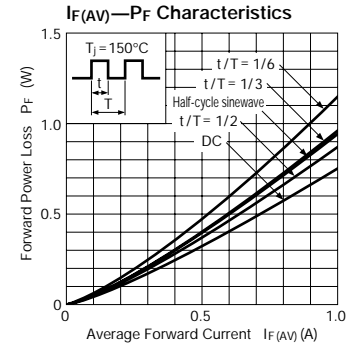
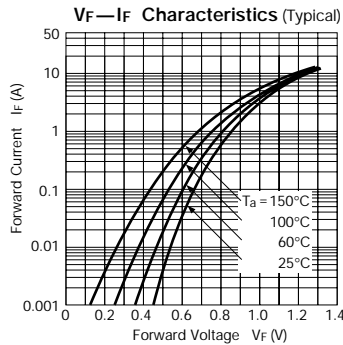
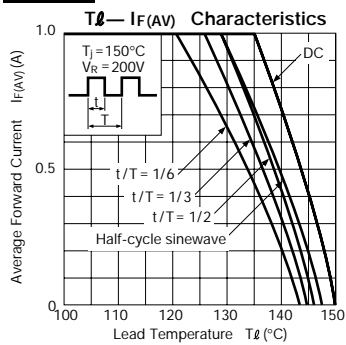

EG 1Y, EG 1Z, EG 1

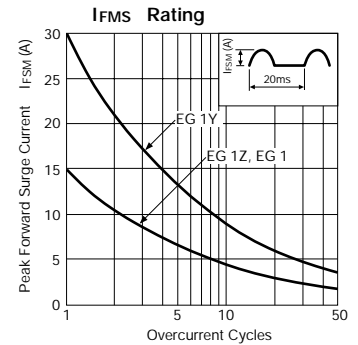
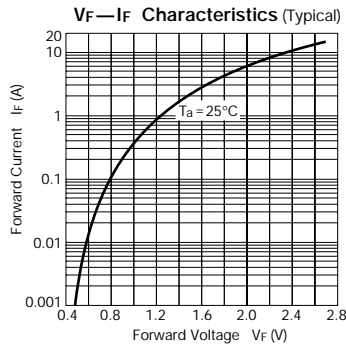
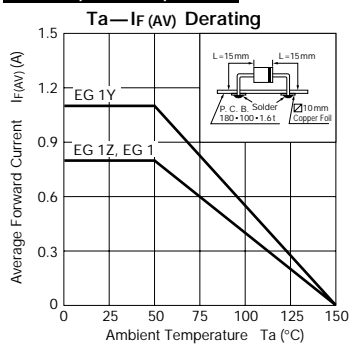

Ultra-Fast-Recovery Rectifier Diodes

EG 1A

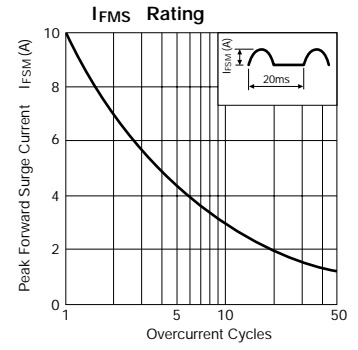
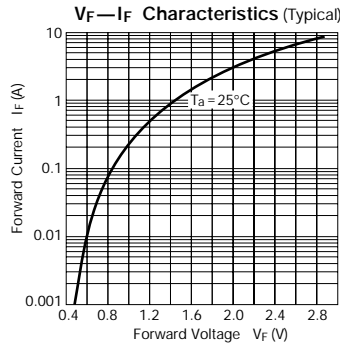
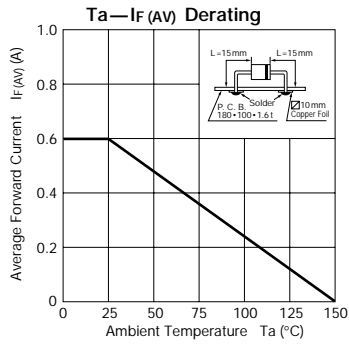

EL 1Z

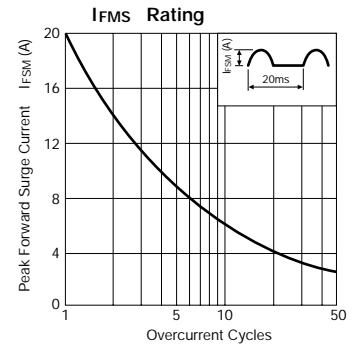
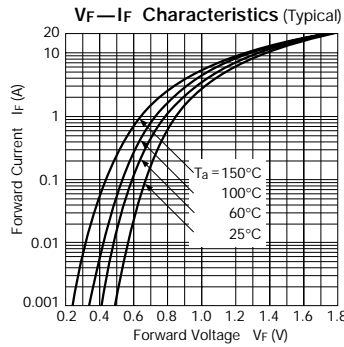
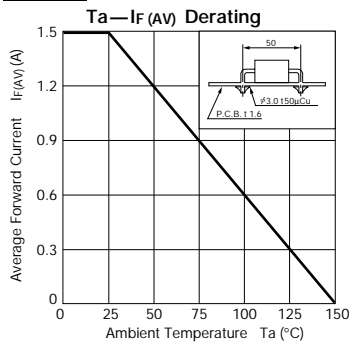

EL 1

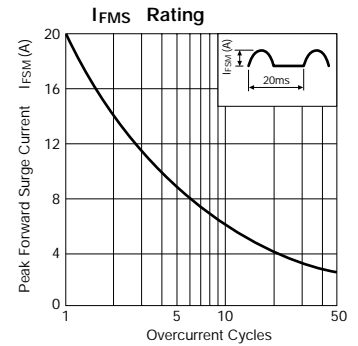
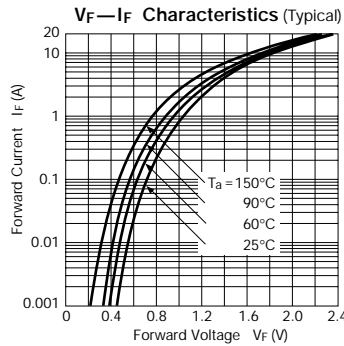
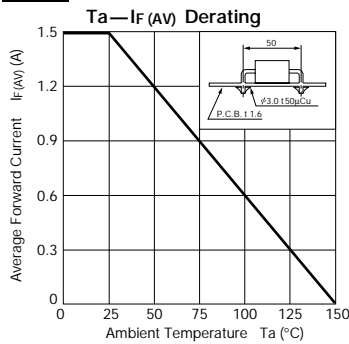

RG10 series

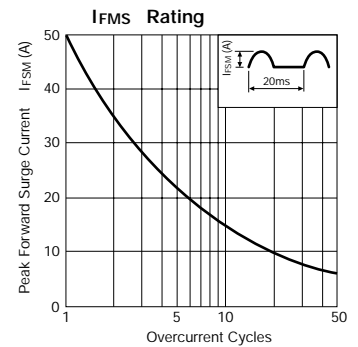
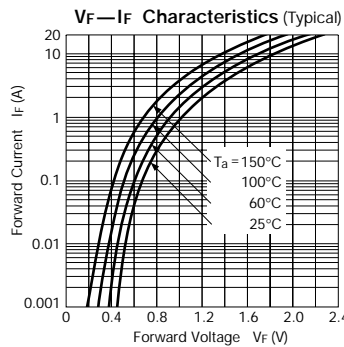
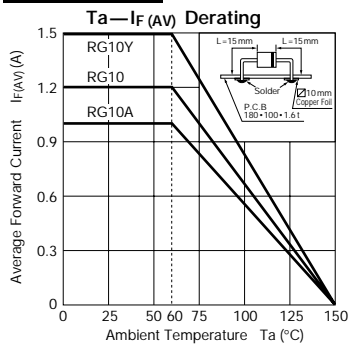

RG 1C

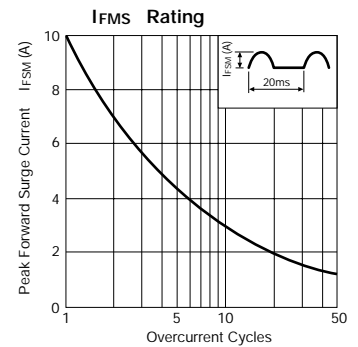
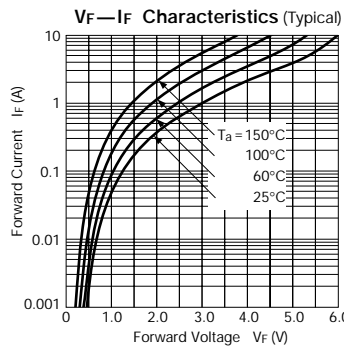
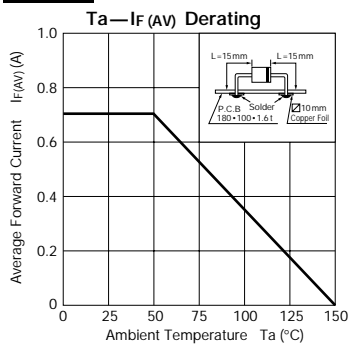

Ultra-Fast-Recovery Rectifier Diodes

RL 10Z

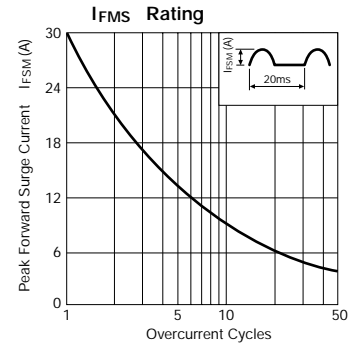
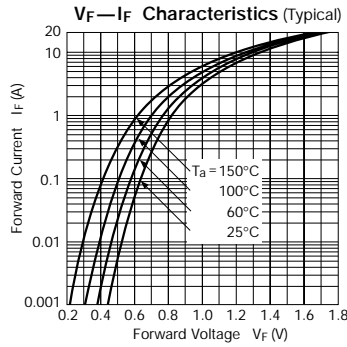
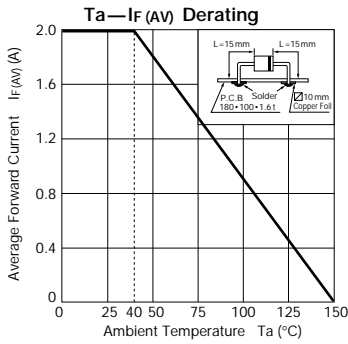

RN 1Z

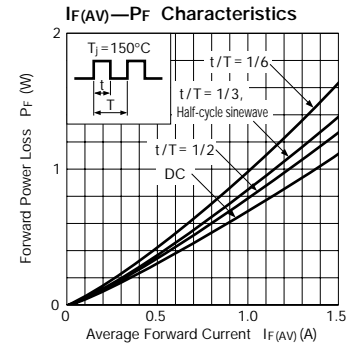
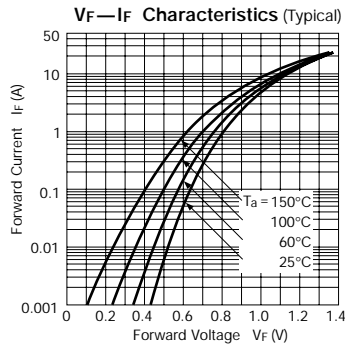
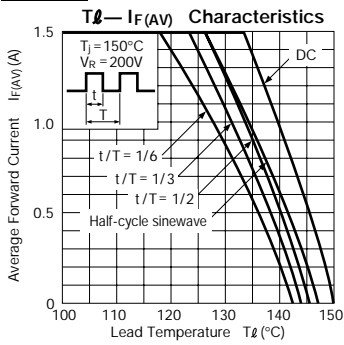

RP 1H

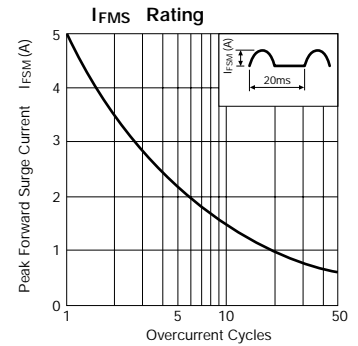
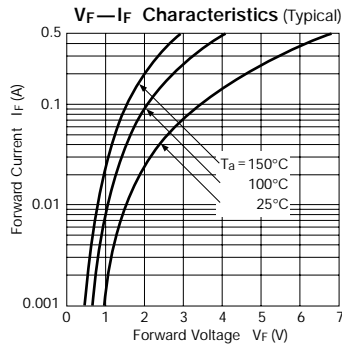
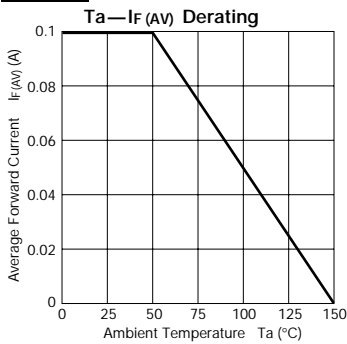

RU 1P

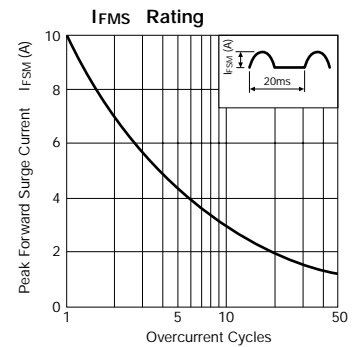
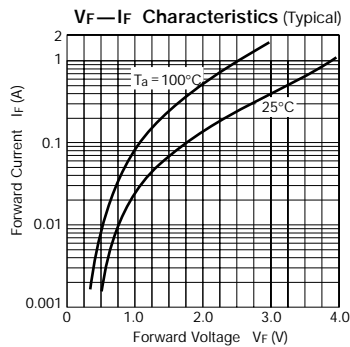
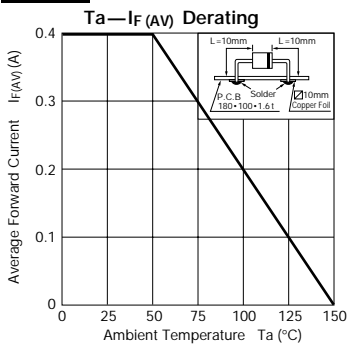

RG 2Y

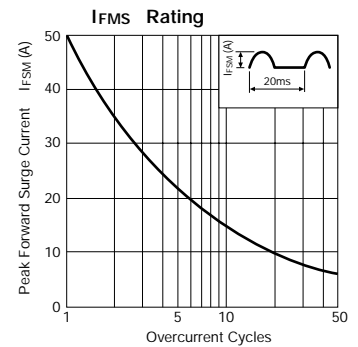
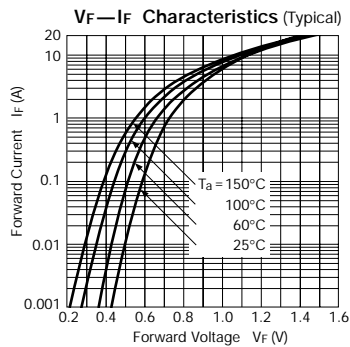
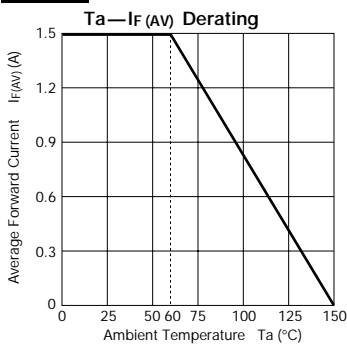

Ultra-Fast-Recovery Rectifier Diodes

RG 2Z

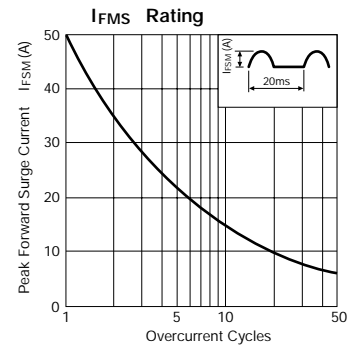
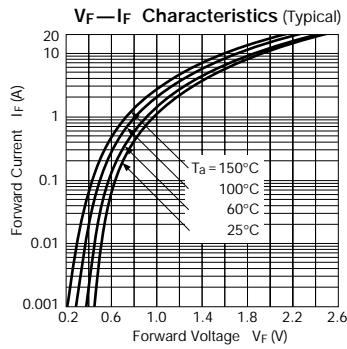
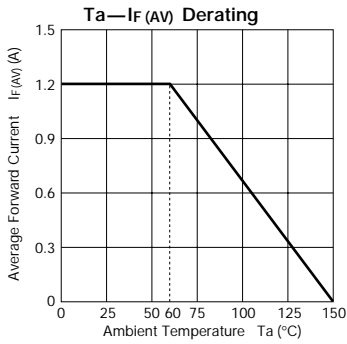

RG 2

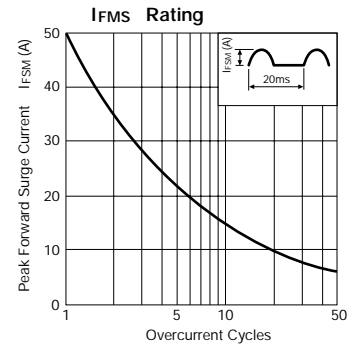
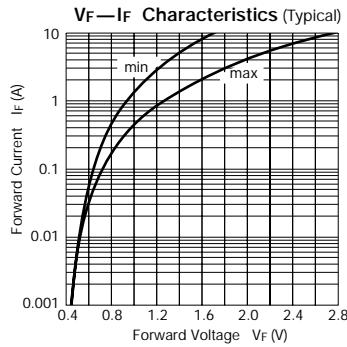
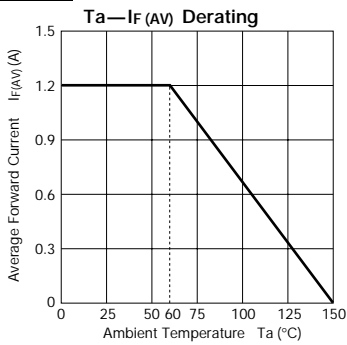

RG 2A

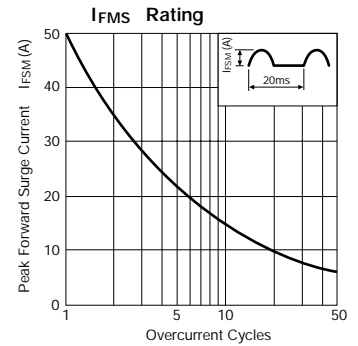
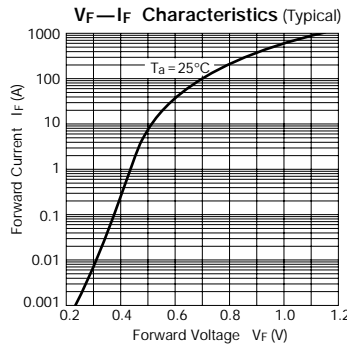
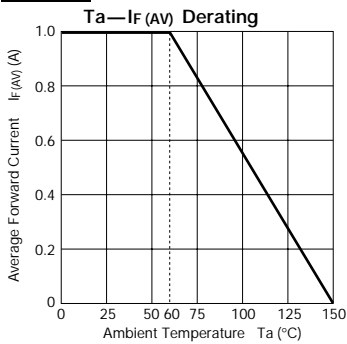

RL 2Z

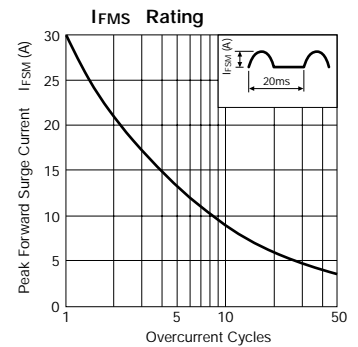
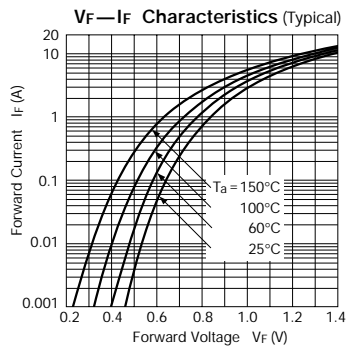
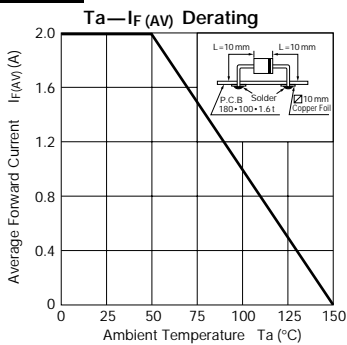

RL 2

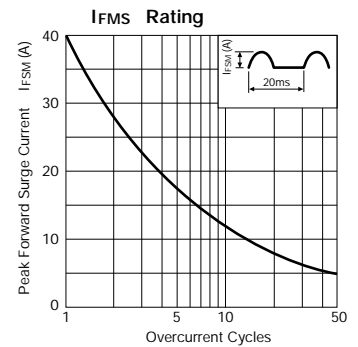
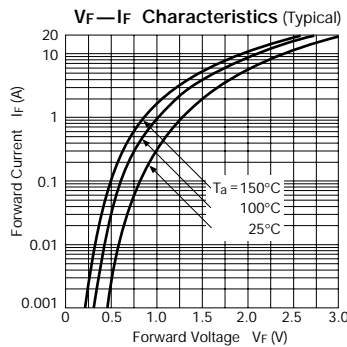
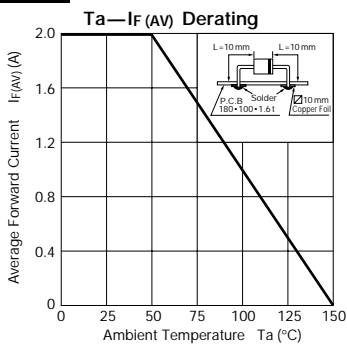

Ultra-Fast-Recovery Rectifier Diodes

RD 2A

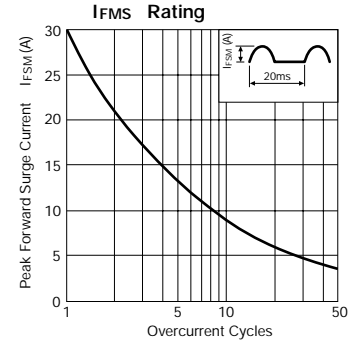
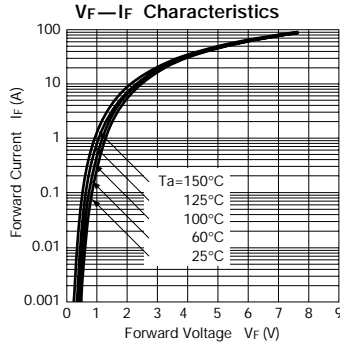
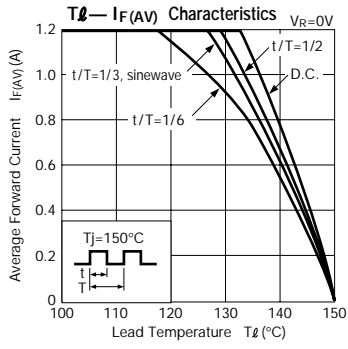

RN 2Z

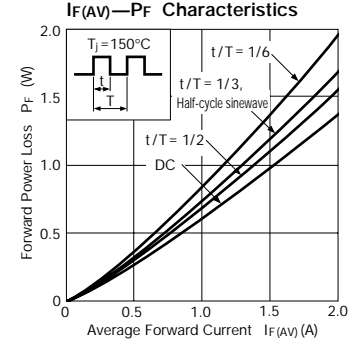
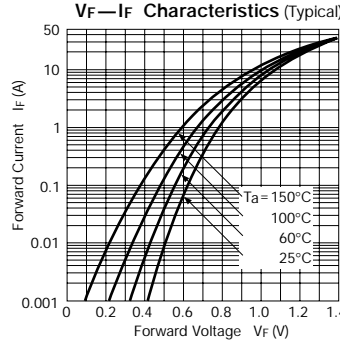
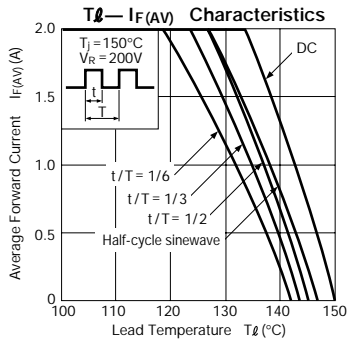

RL 3Z

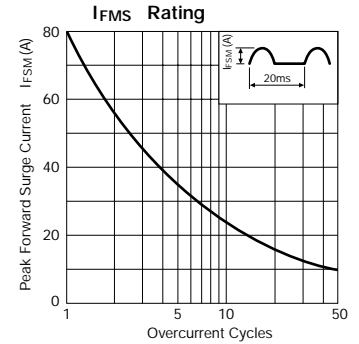
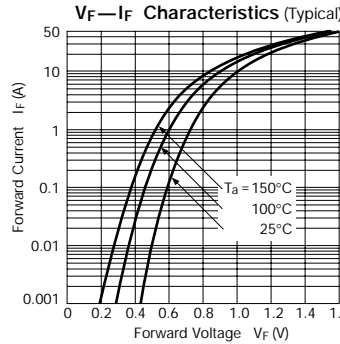
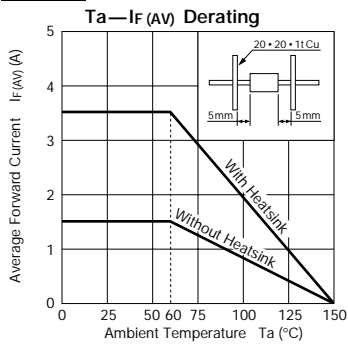

RL 3

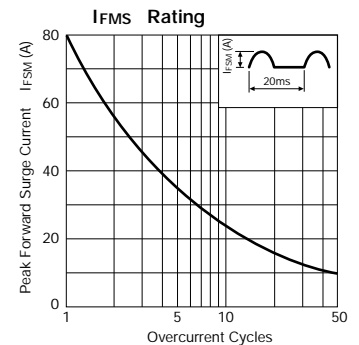
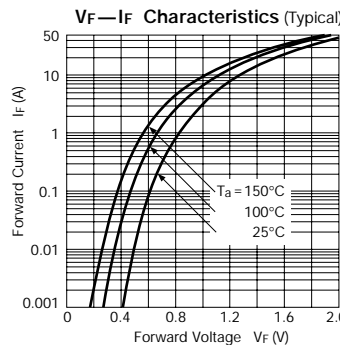
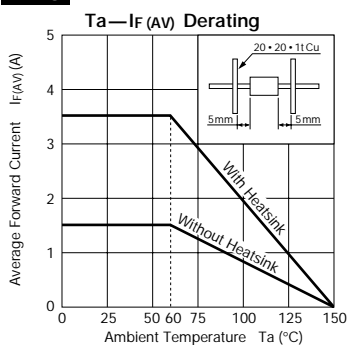

RL 3A

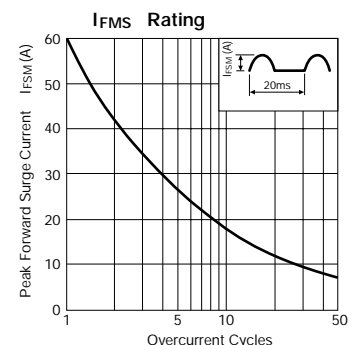
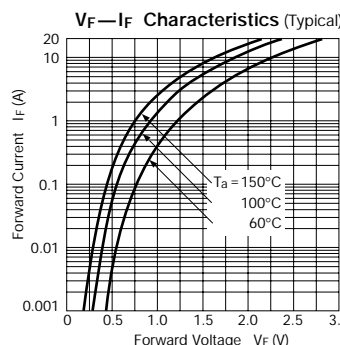
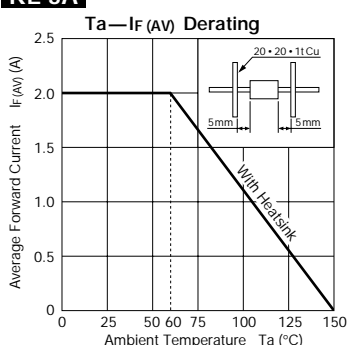

Ultra-Fast-Recovery Rectifier Diodes

RN 3Z

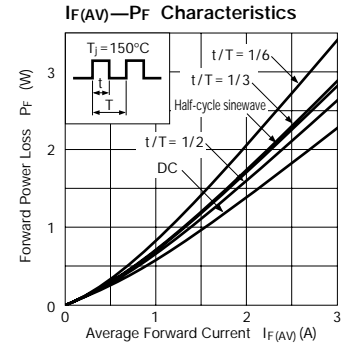
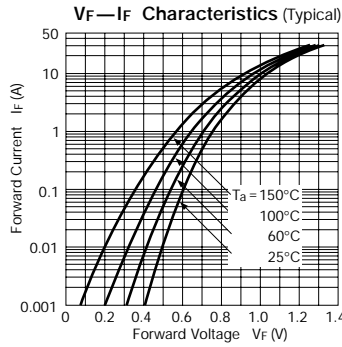
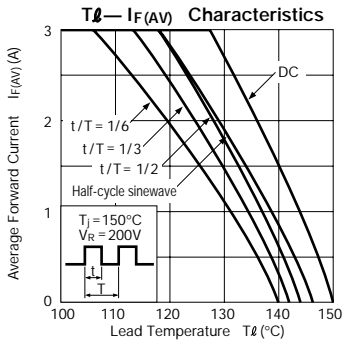

RX 3Z

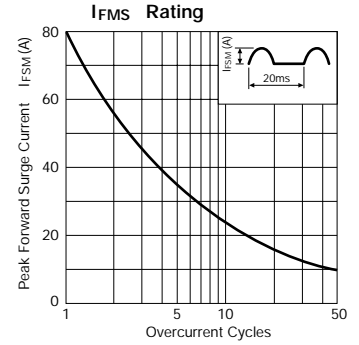
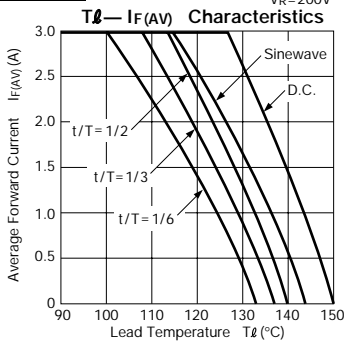

RG 4Y

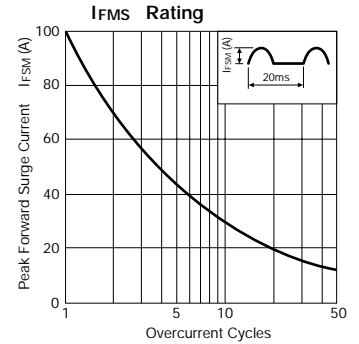
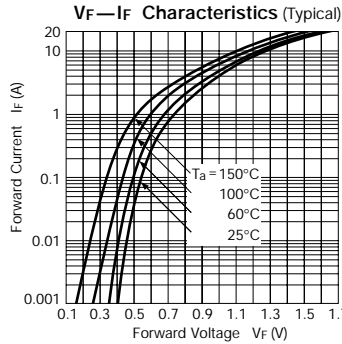
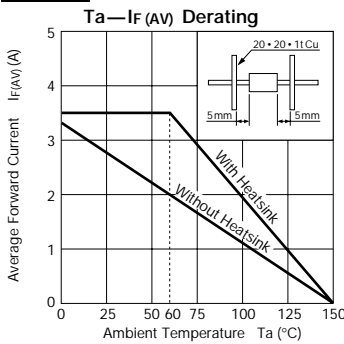

RG 4Z, RG 4, RG 4A

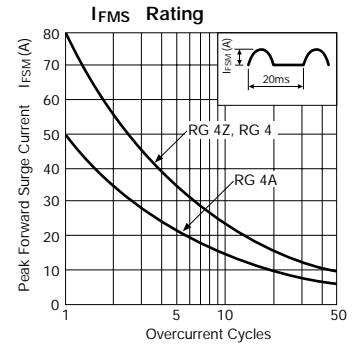
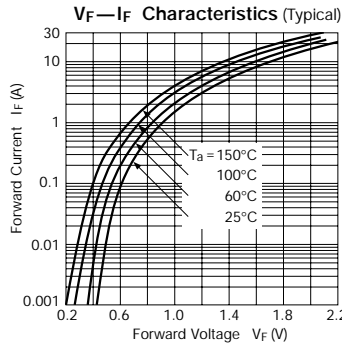
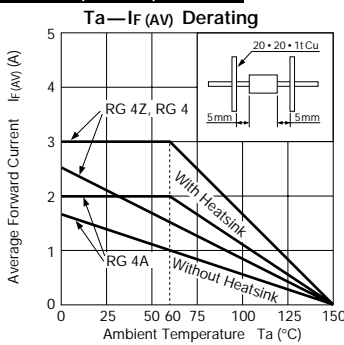

RG 4C

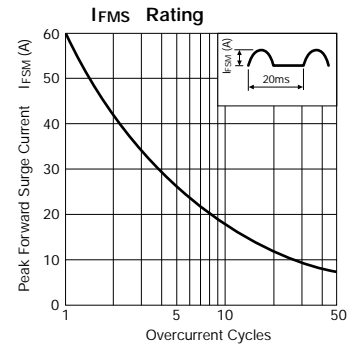
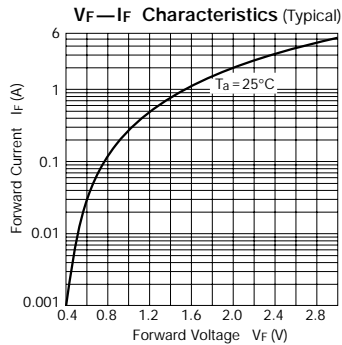
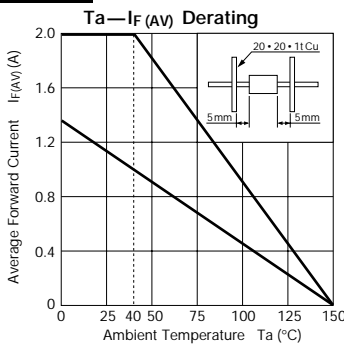

Ultra-Fast-Recovery Rectifier Diodes

RL 4Z

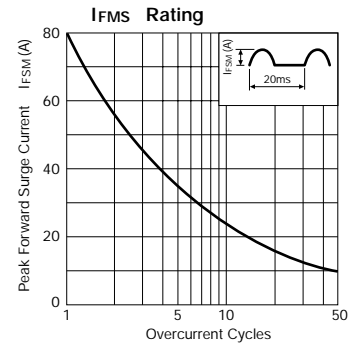
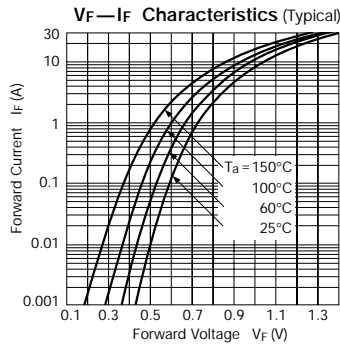
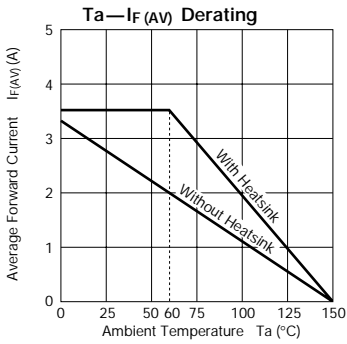

RL 4A

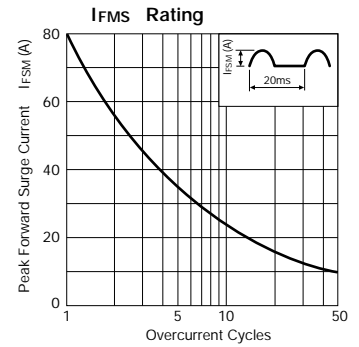
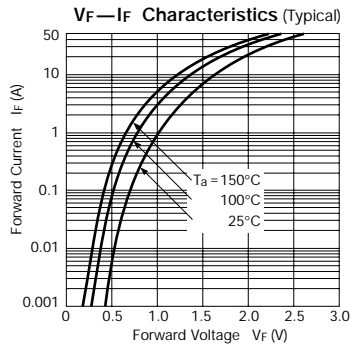
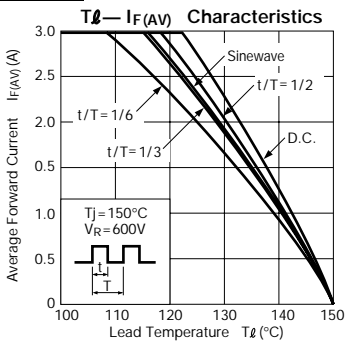

RN 4Z

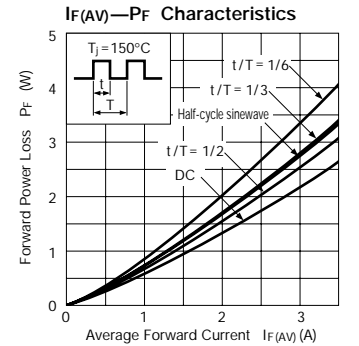
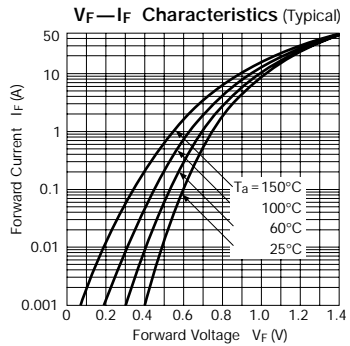
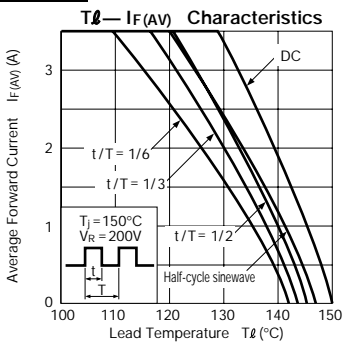

FMC-G28S

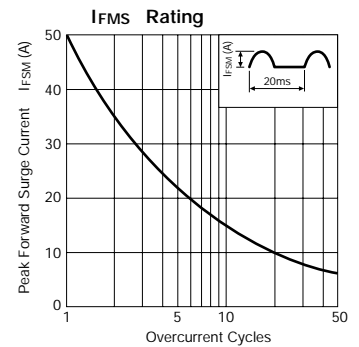
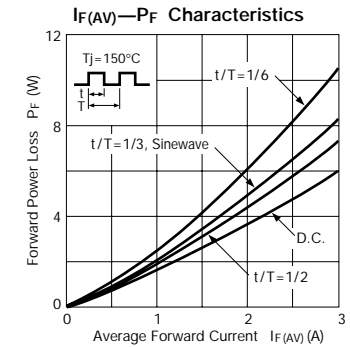
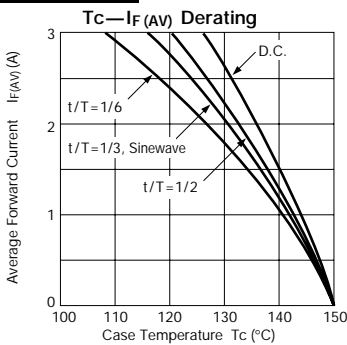

FMC-G28SL

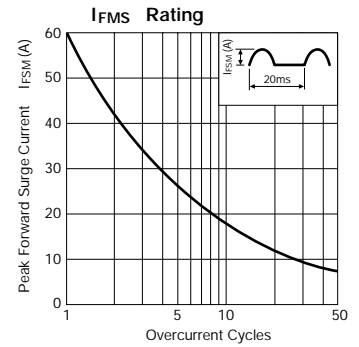
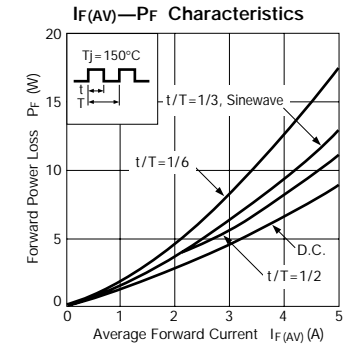
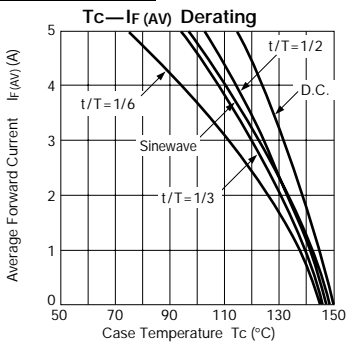

Ultra-Fast-Recovery Rectifier Diodes

FMG-G26S

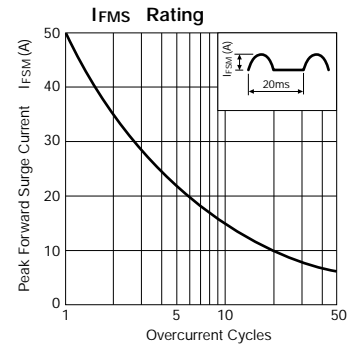
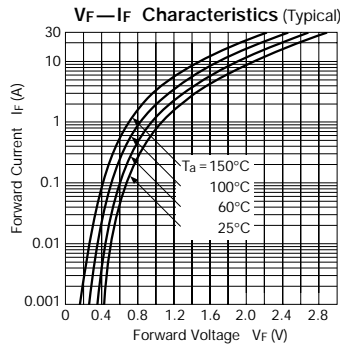
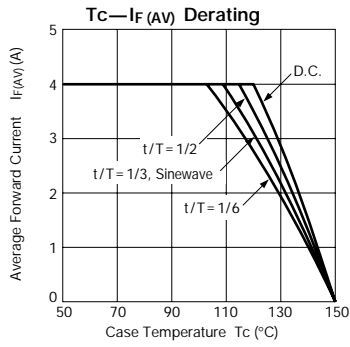

FMG-G2CS

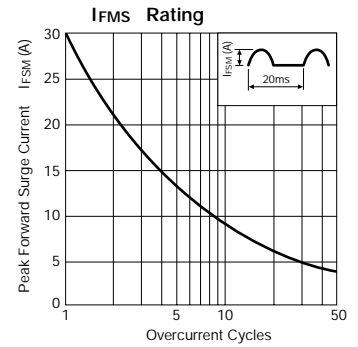
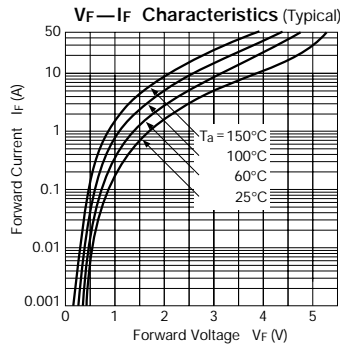
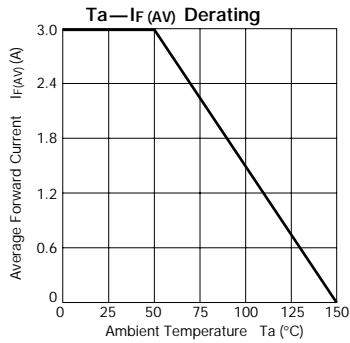

FML-G12S

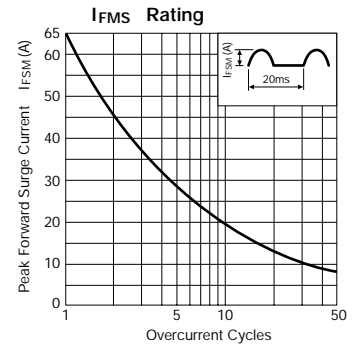
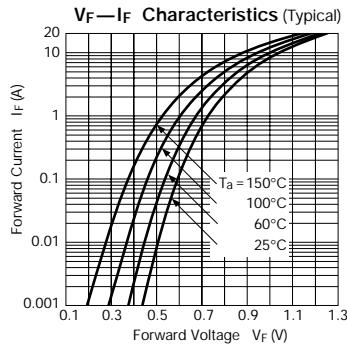
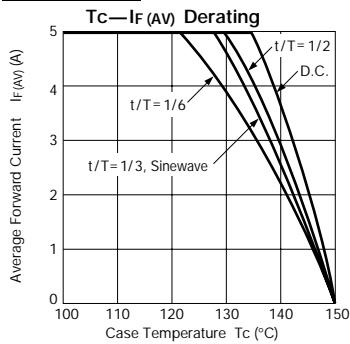

FML-G13S, G14S

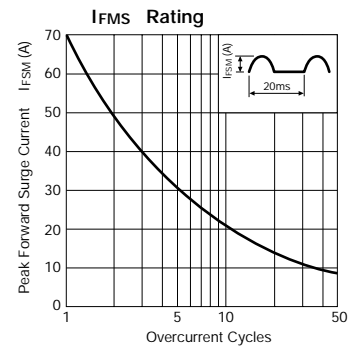
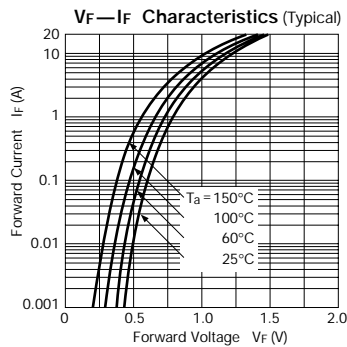
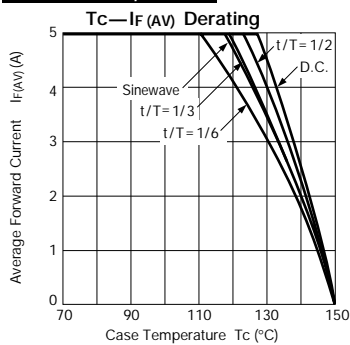

FML-G16S

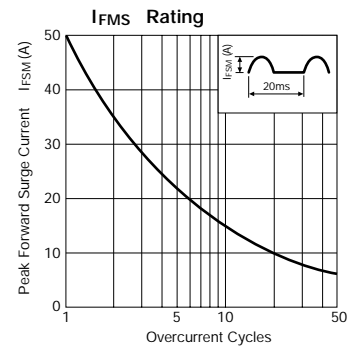
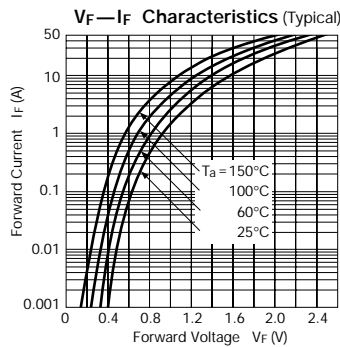
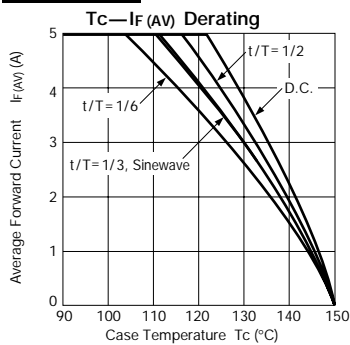

Ultra-Fast-Recovery Rectifier Diodes

FMN-G12S

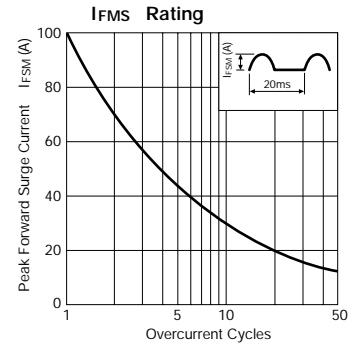
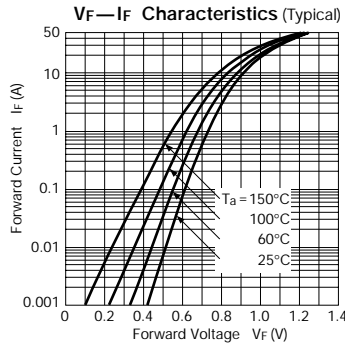
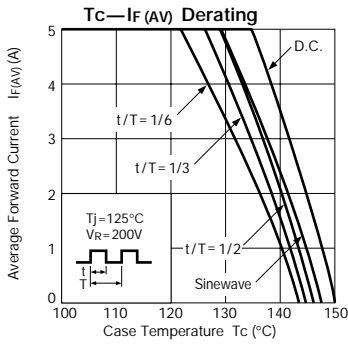

FMP-G12S

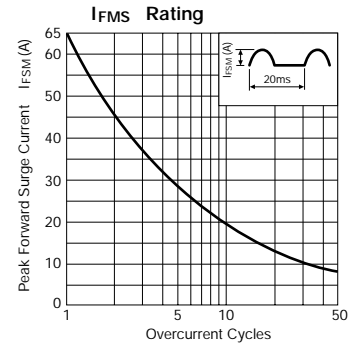
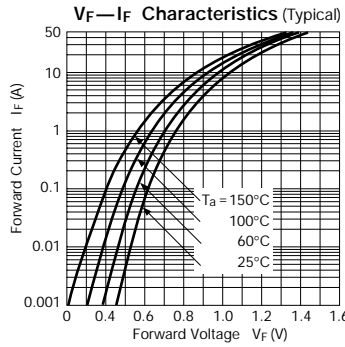
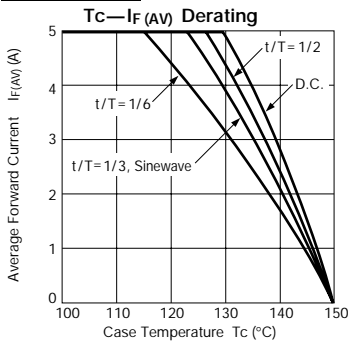

FMX-G12S

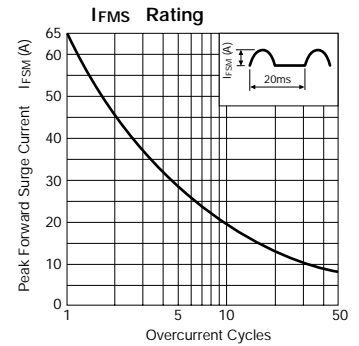
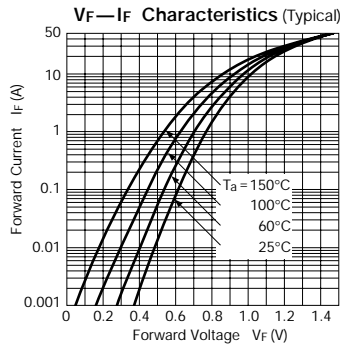
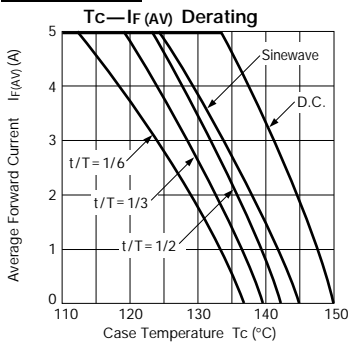

FML-G22S

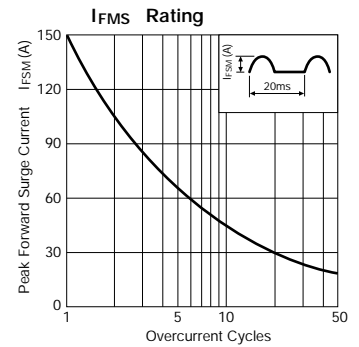
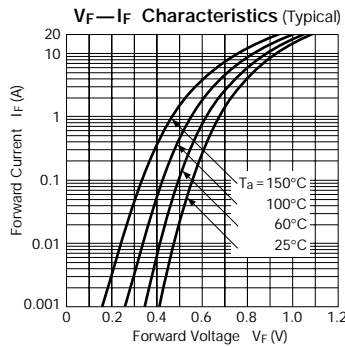
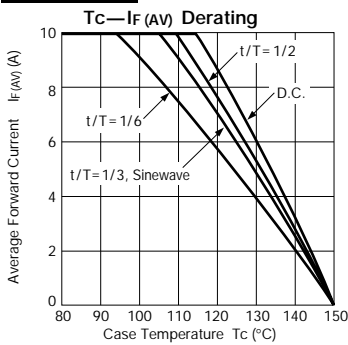

FMX-G22S

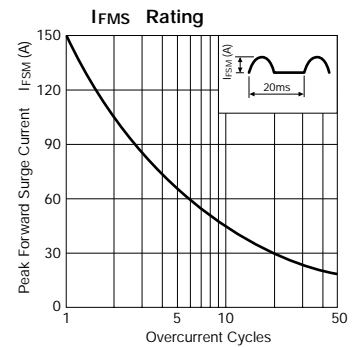
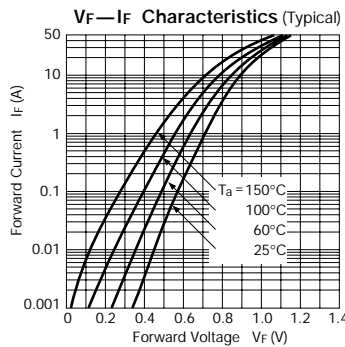
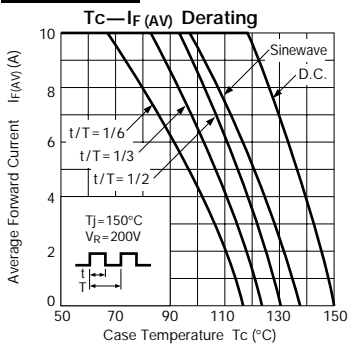

Ultra-Fast-Recovery Rectifier Diodes

FMG-G36S

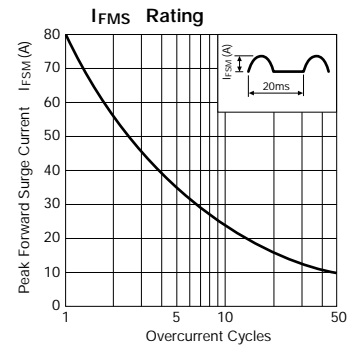
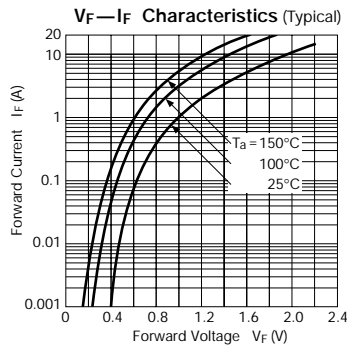
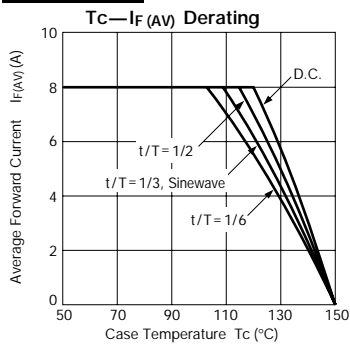

FMG-G3CS

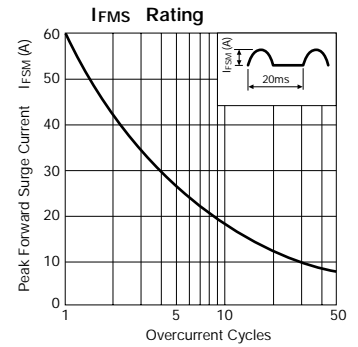
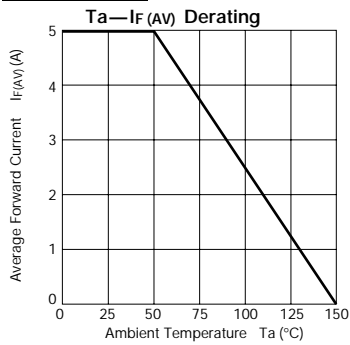

FMC-26U, 26UA

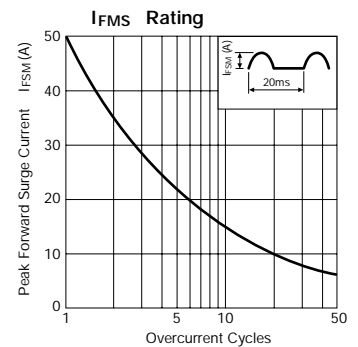
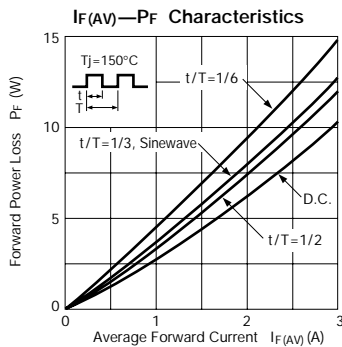
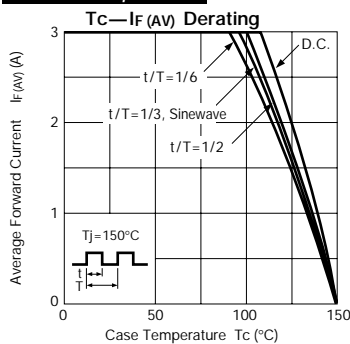

FMC-28U, 28UA

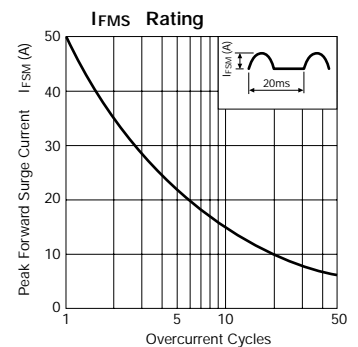
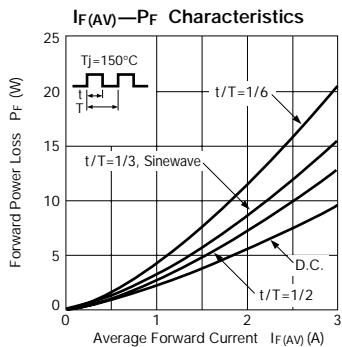
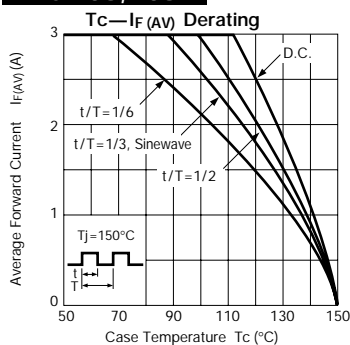

FMG-12S/R, 13S/R

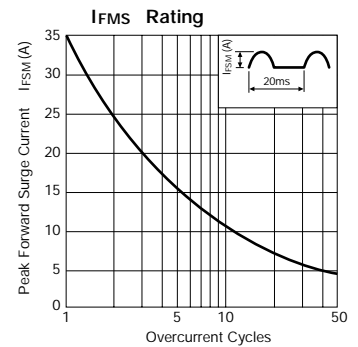
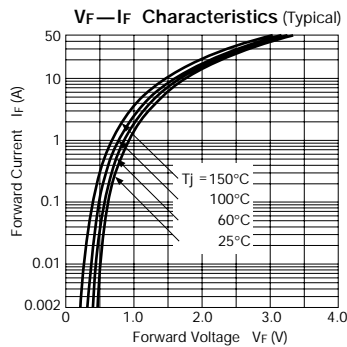
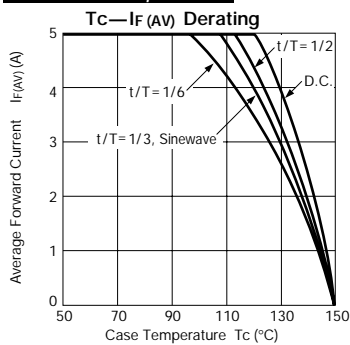

Ultra-Fast-Recovery Rectifier Diodes

FMG-14S/R

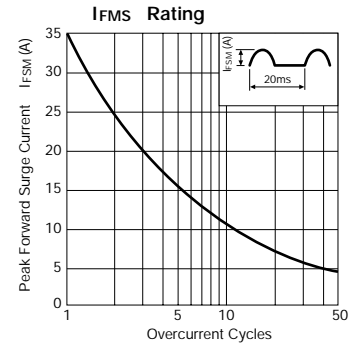
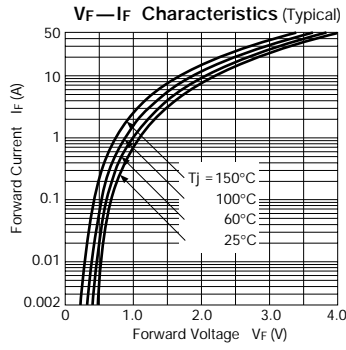
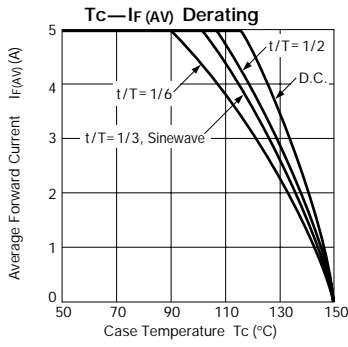

FMG-22S/R, 23S/R

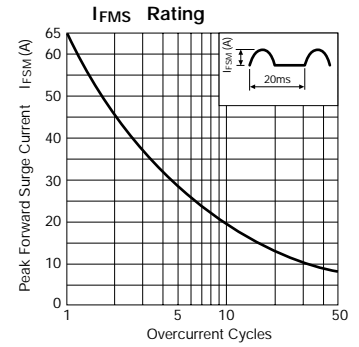
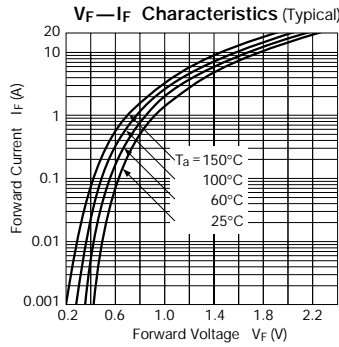
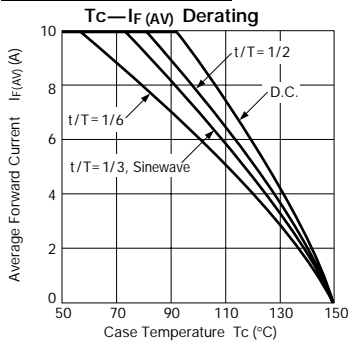

FMG-24S/R

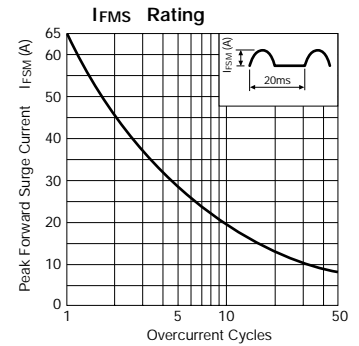
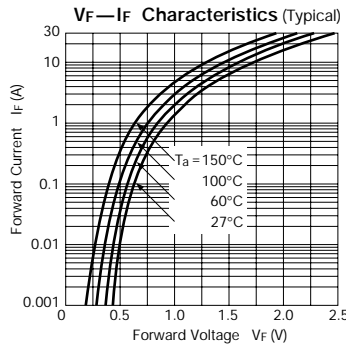
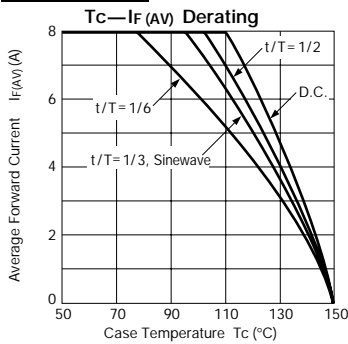

FMG-26S/R

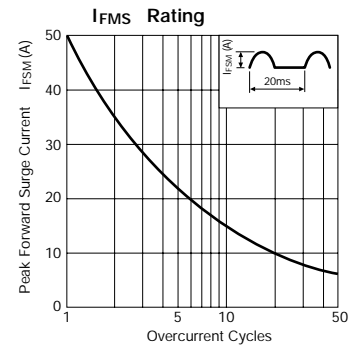
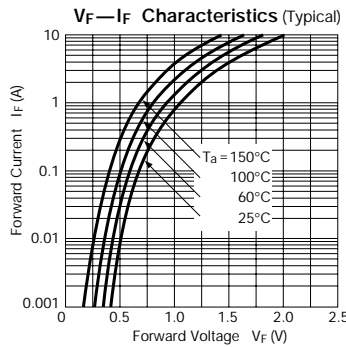
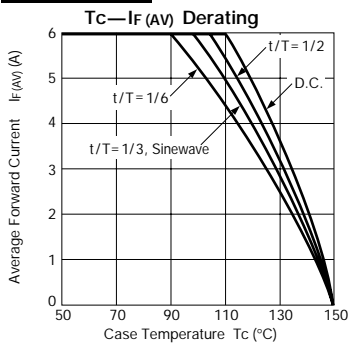

FML-12S

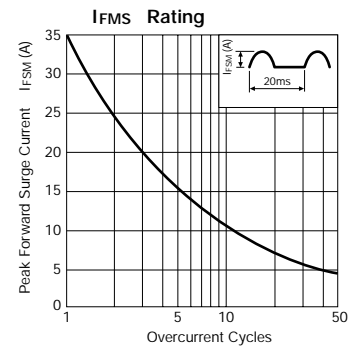
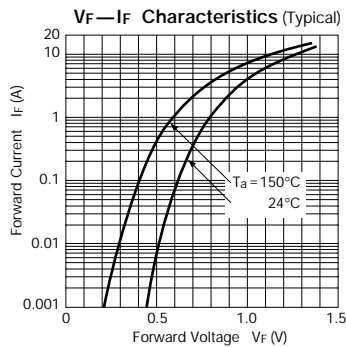
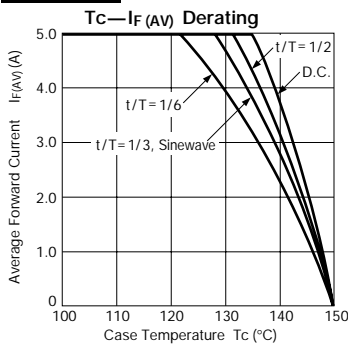

Ultra-Fast-Recovery Rectifier Diodes

FML-13S

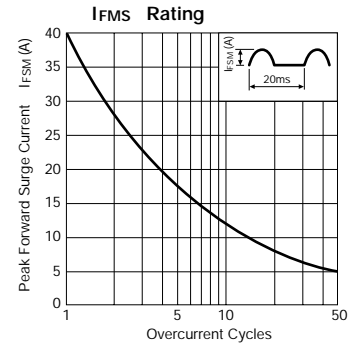
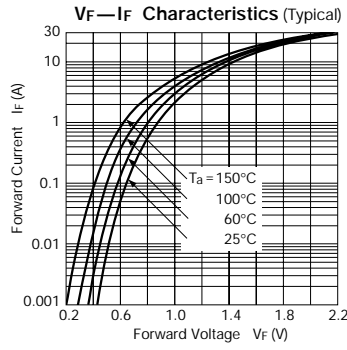
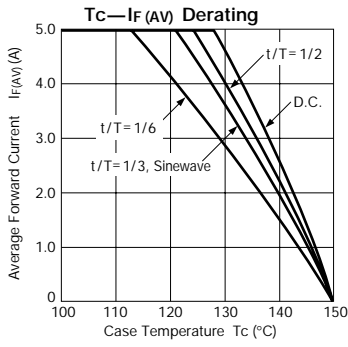

FML-14S

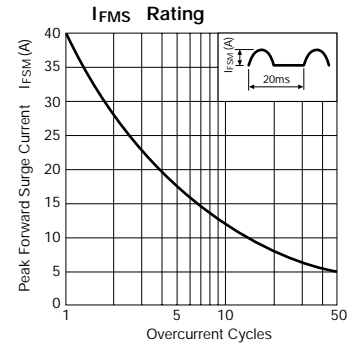
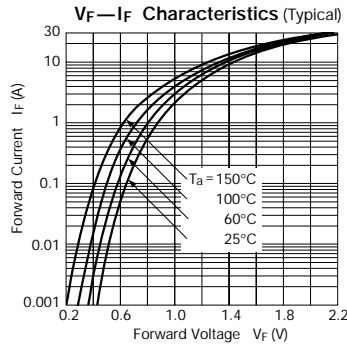
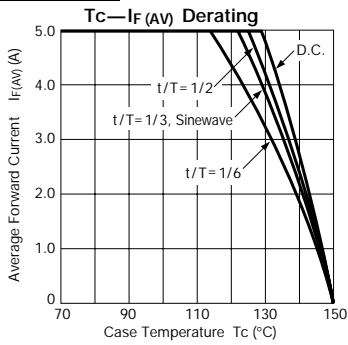

FML-22S

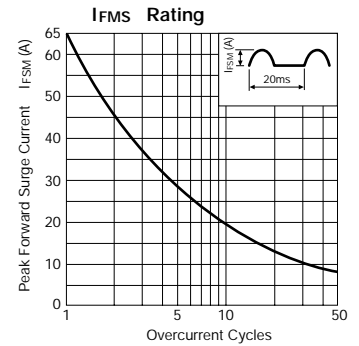
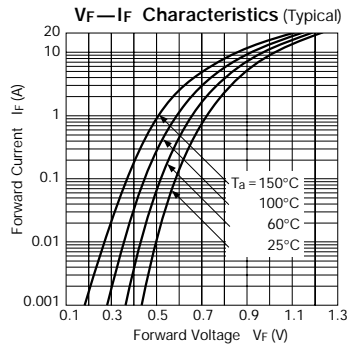
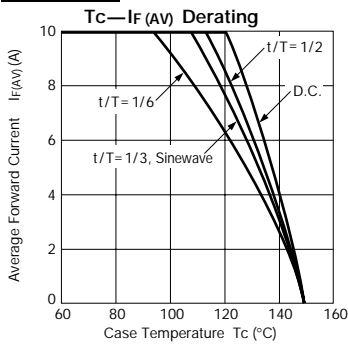

FML-23S

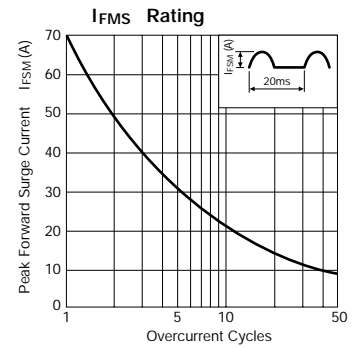
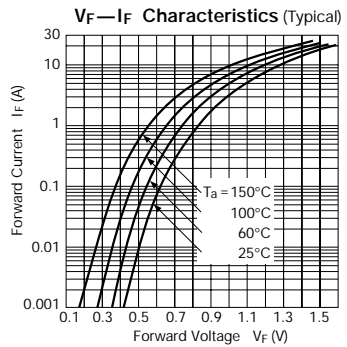
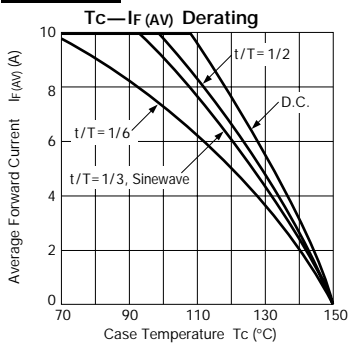

FML-24S

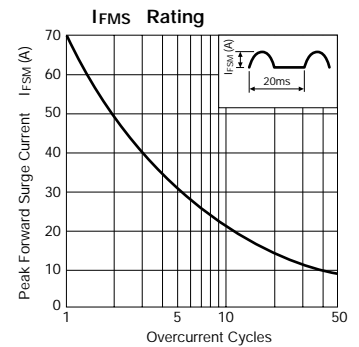
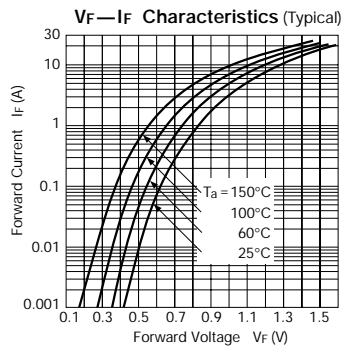
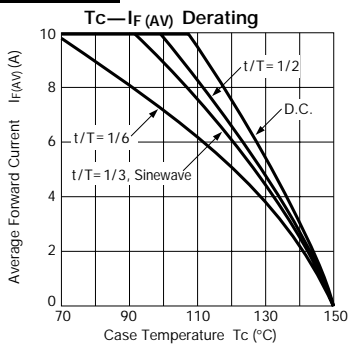

Ultra-Fast-Recovery Rectifier Diodes

FMX-12S

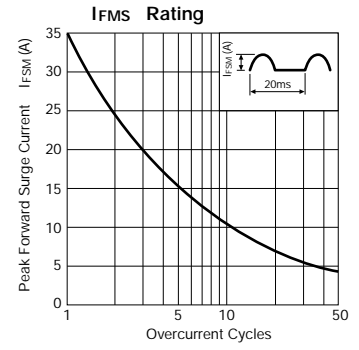
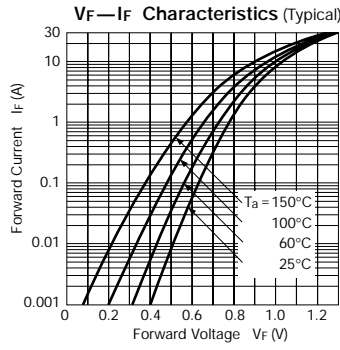
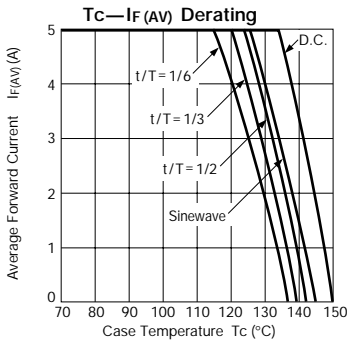

FMX-22S

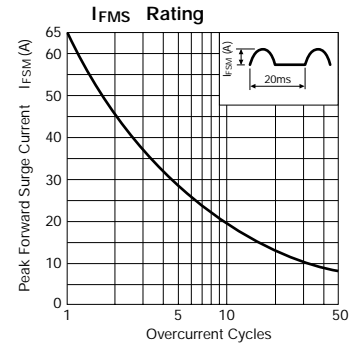
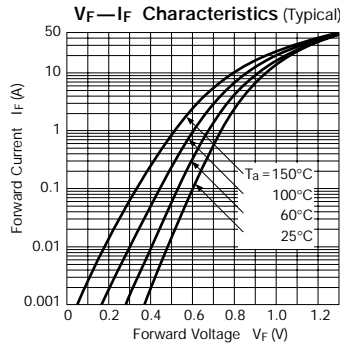
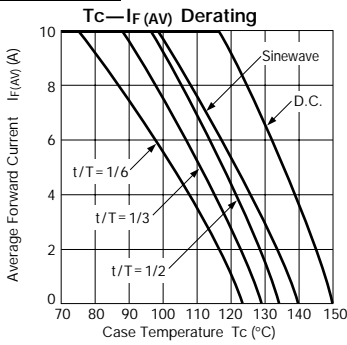

FMX-22SL

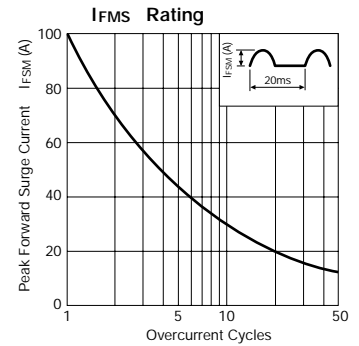
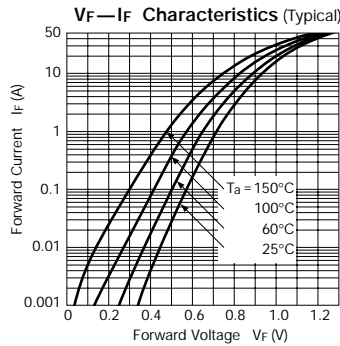
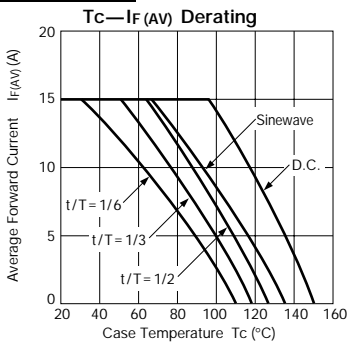

FMG-32S/R, 33S/R

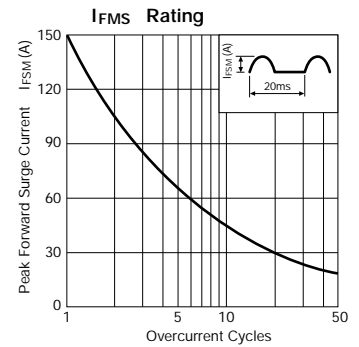
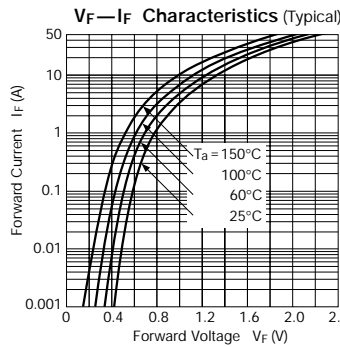
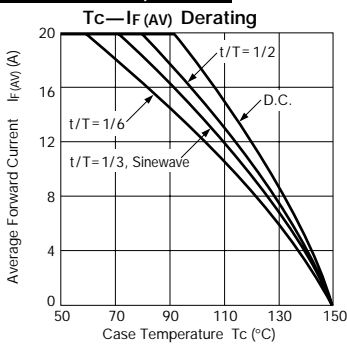

FMG-34S/R

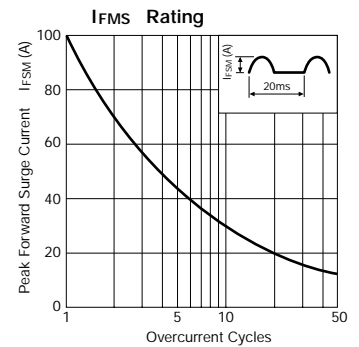
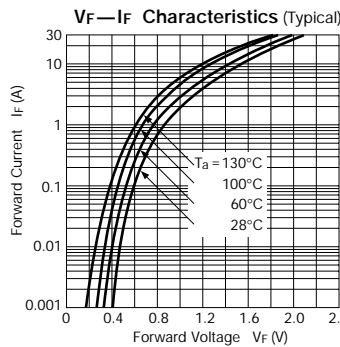
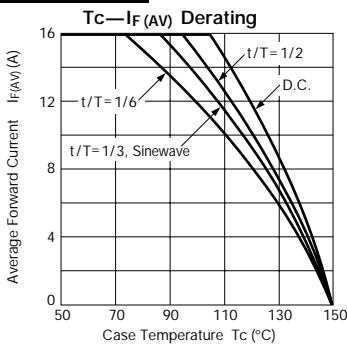

Ultra-Fast-Recovery Rectifier Diodes

FMG-36S/R

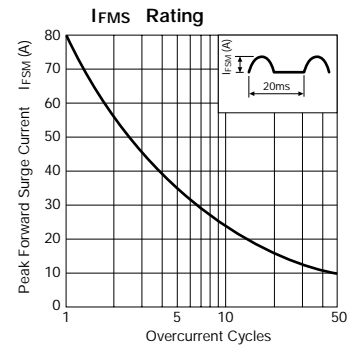
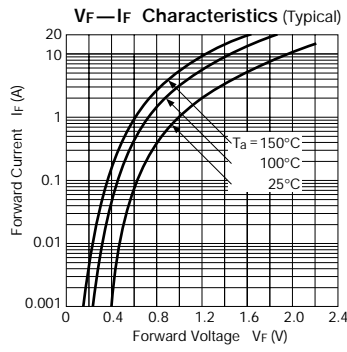
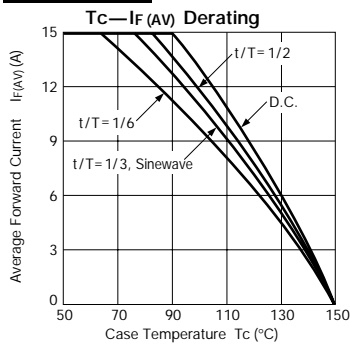

FML-32S

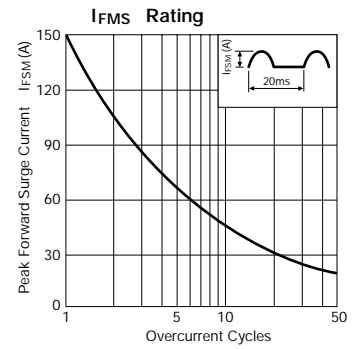
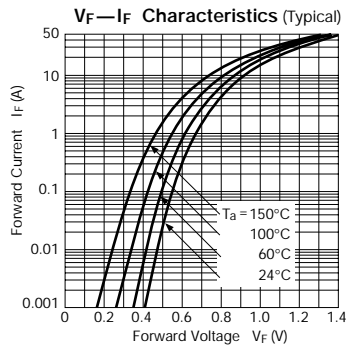
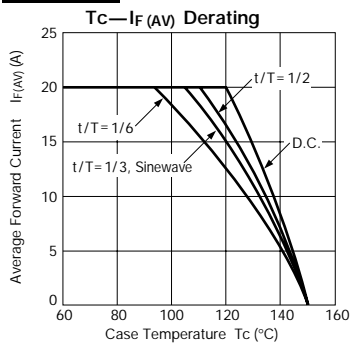

FML-33S, 34S

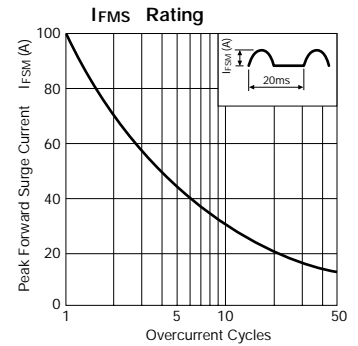
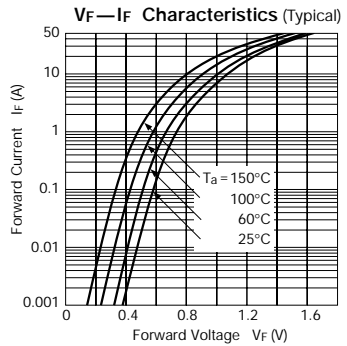
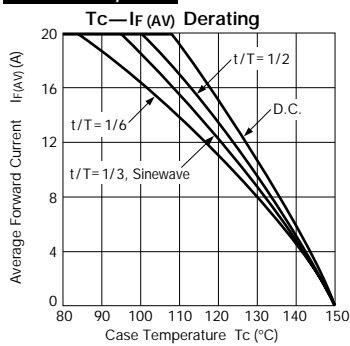

FML-36S

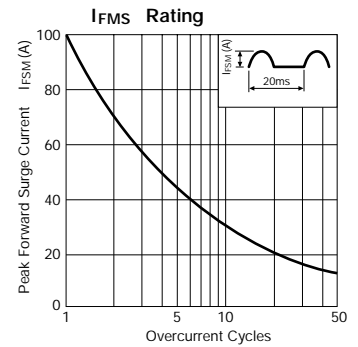
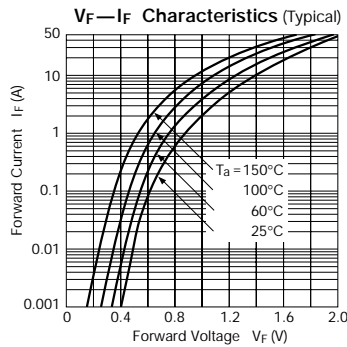
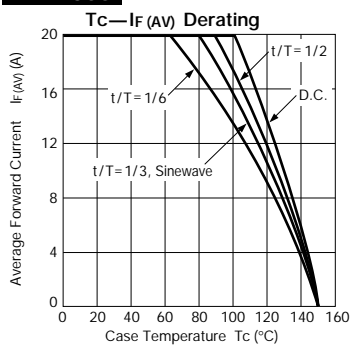

FMX-32S

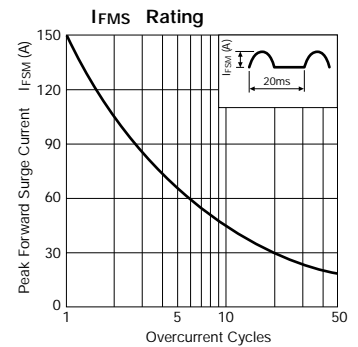
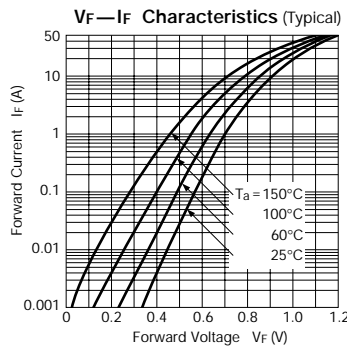
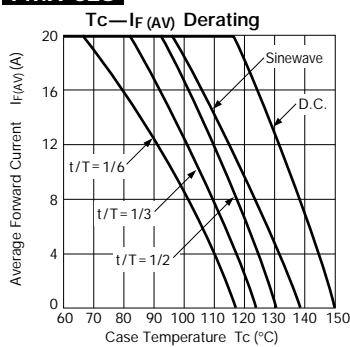

Ultra-Fast-Recovery Rectifier Diodes

RBV-402L

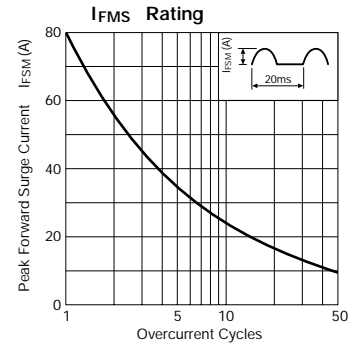
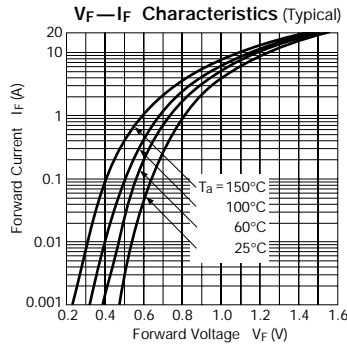
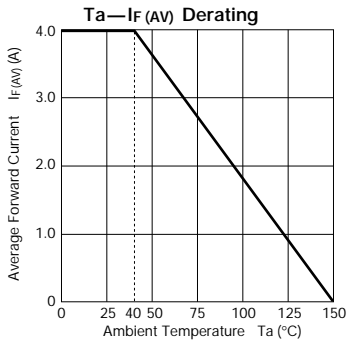

RBV-602L

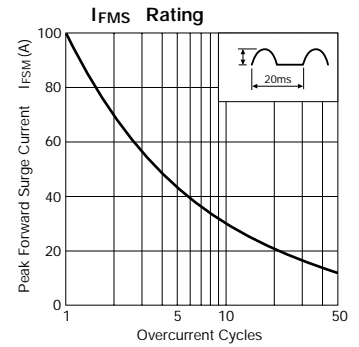
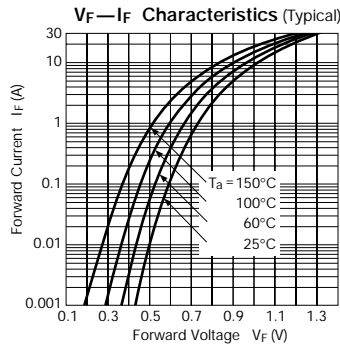
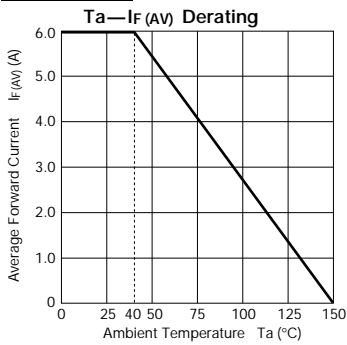

FMX-G16S

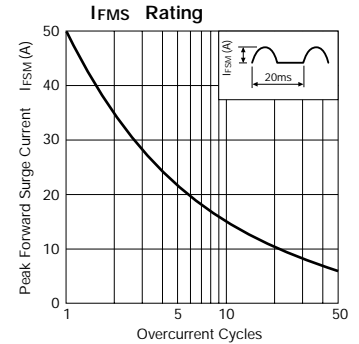
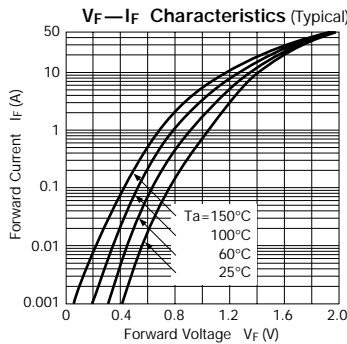
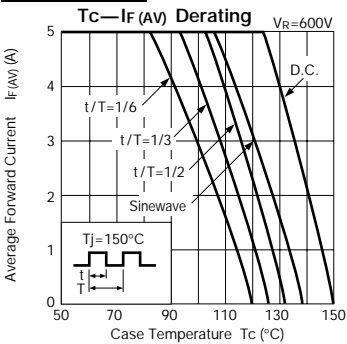

AL01 Under development

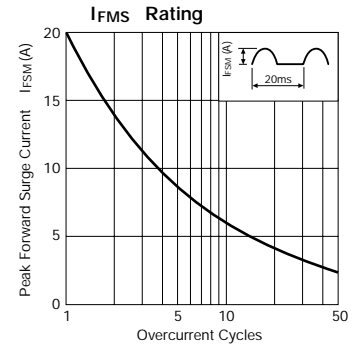
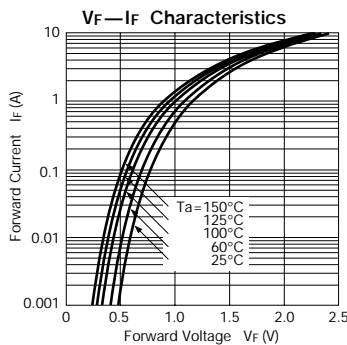
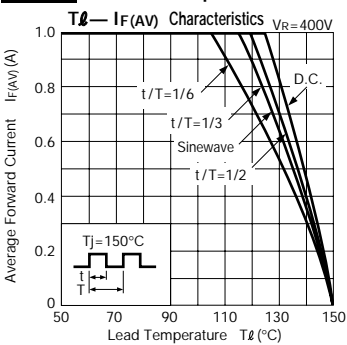

RL 31 Under development

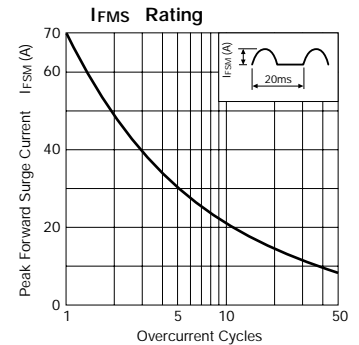
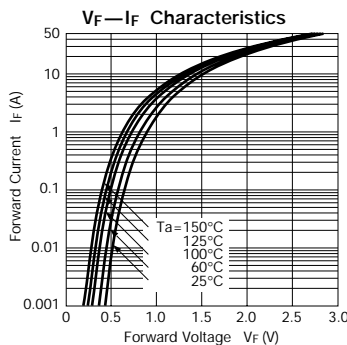
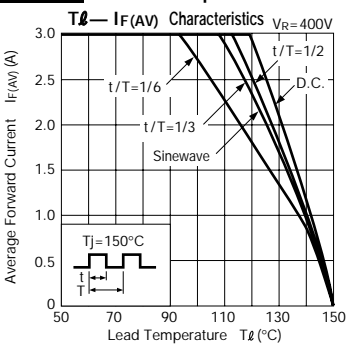

Characteristic Curves Ultra-Fast-Recovery Rectifier Diodes

RX 10Z Under development

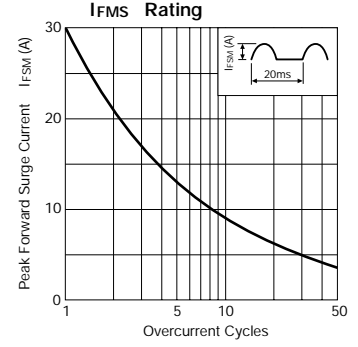
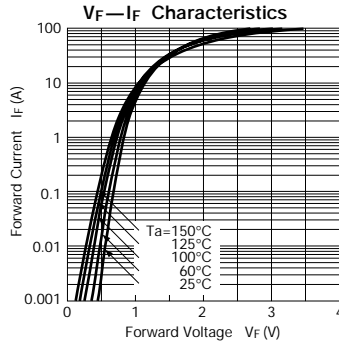
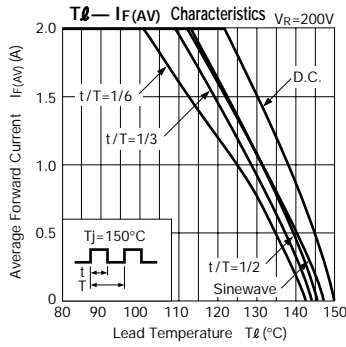

FMX-G26S

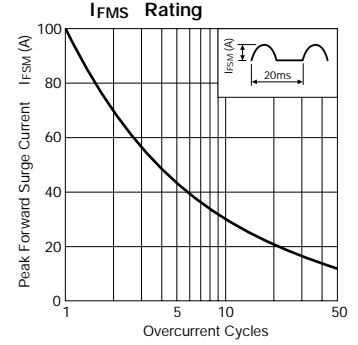
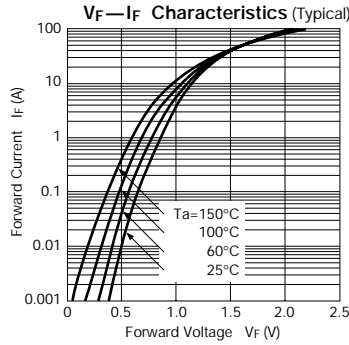
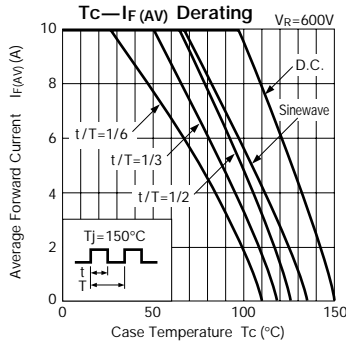

MP3-306

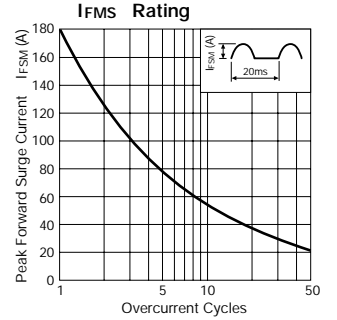
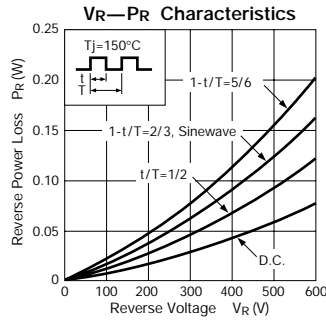
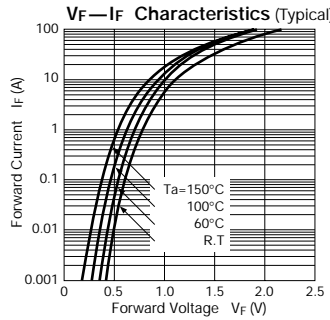
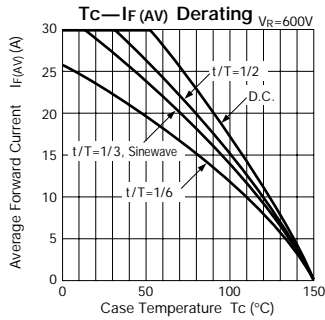

MPL-102S

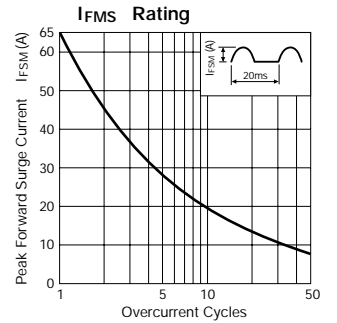
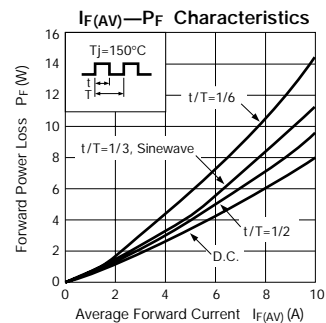
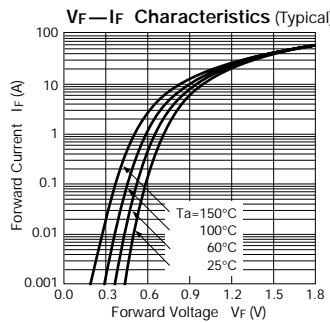
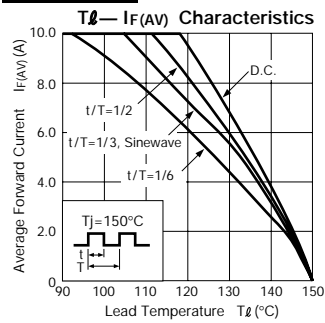

MP2-202S

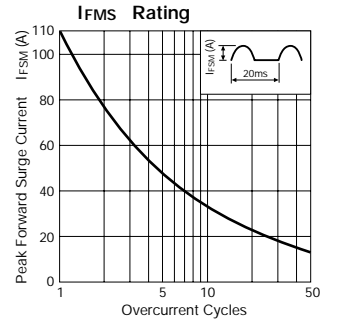
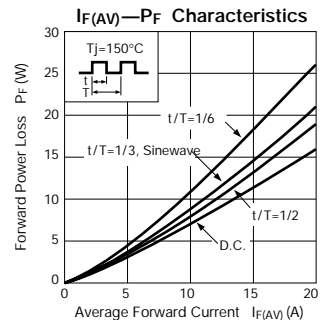
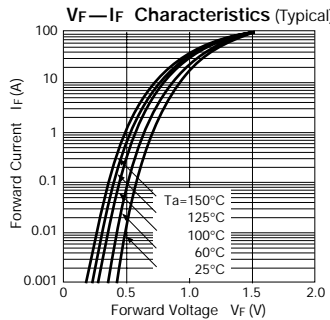
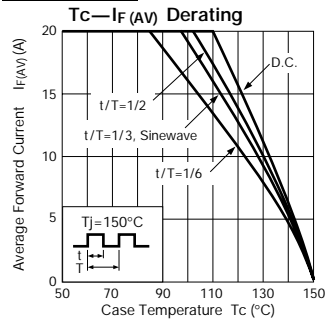

Ultra-Fast-Recovery Rectifier Diodes

FMX-2203

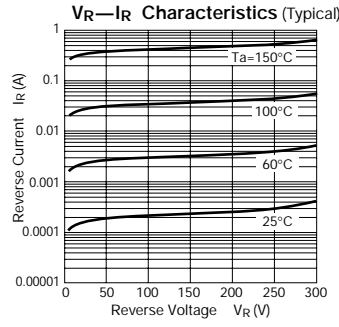
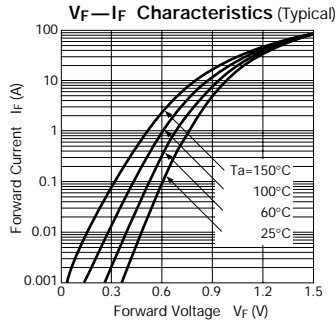
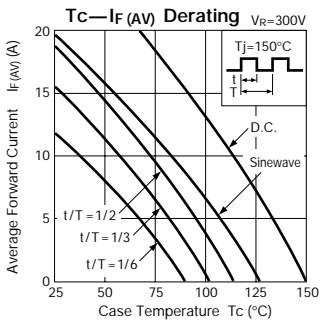

SFPL-64

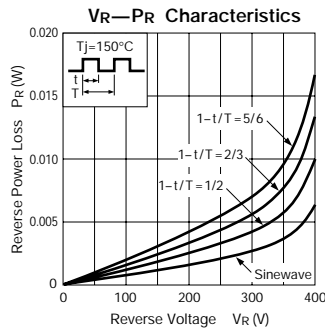
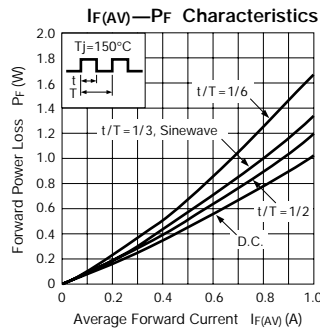
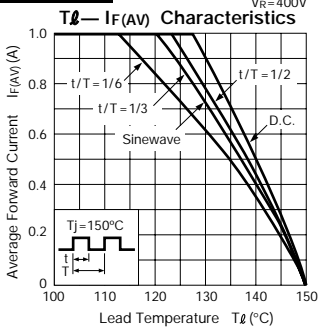

MPX-2103

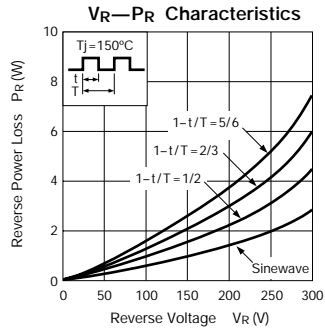
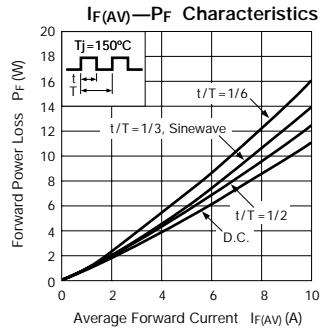
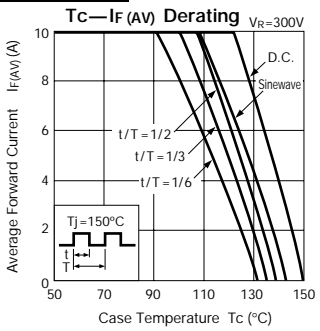

FMW-2204

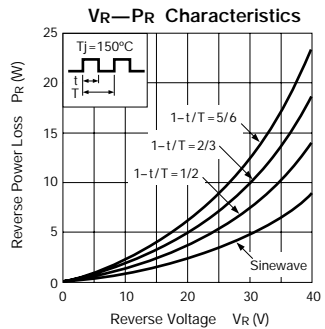
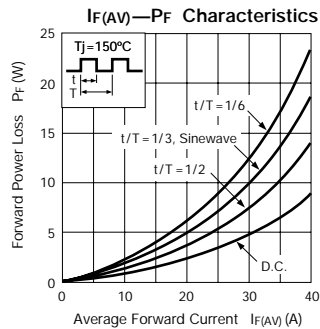
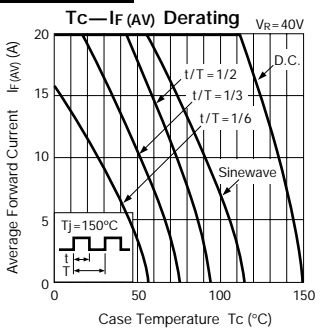

Characteristic Curves Schottky Barrier Diodes

MI1A3

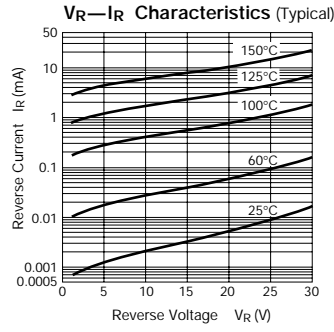
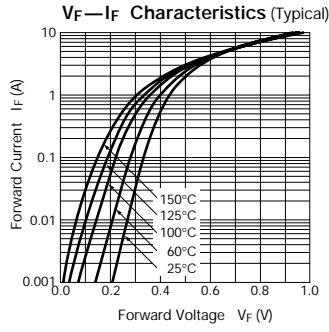
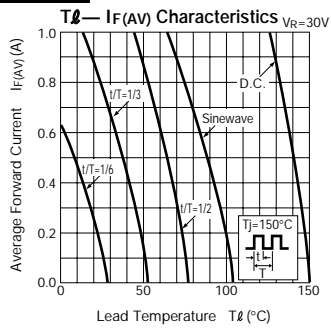

SFPB-54

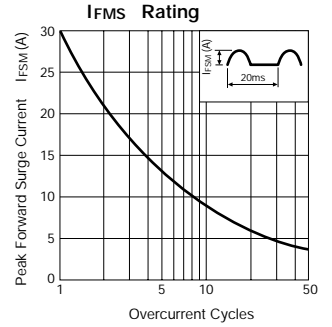
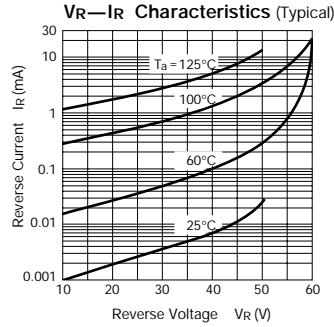
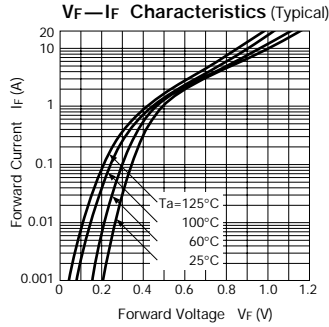
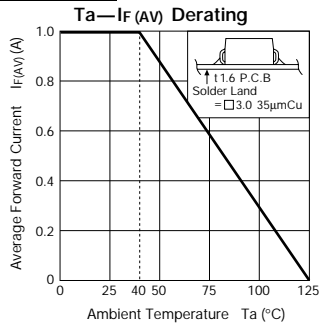

SFPB-56

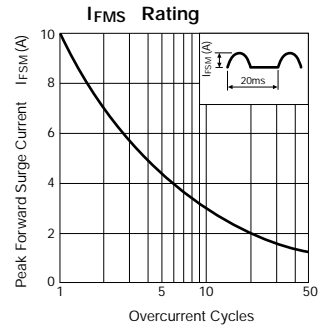
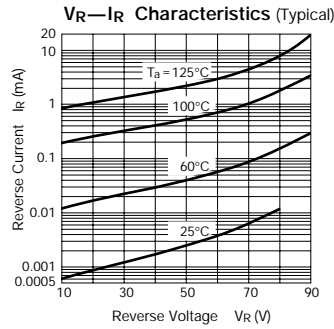
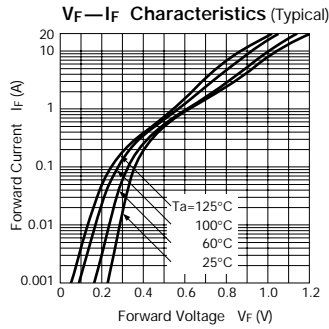
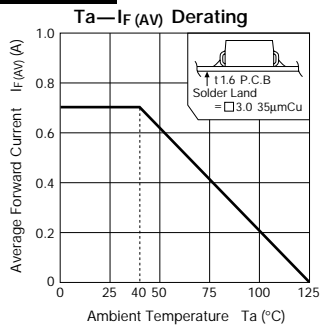

SFPB-59

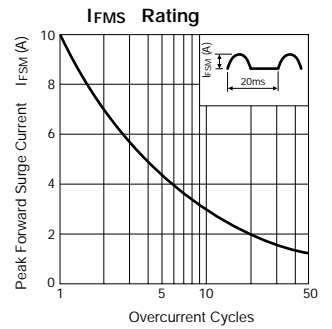
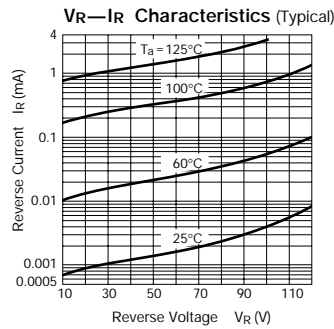
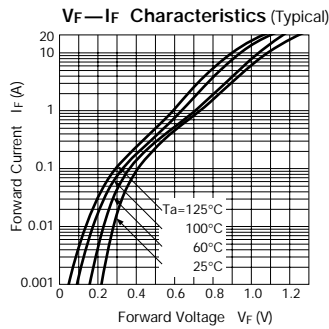
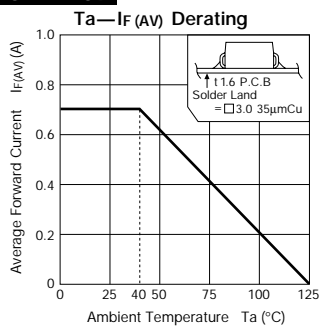

Characteristic Curves Schottky Barrier Diodes

SFPB-64

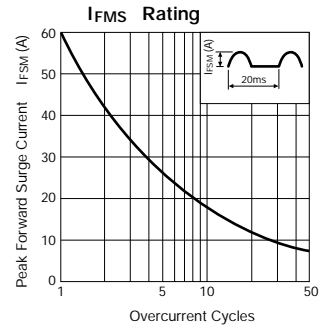
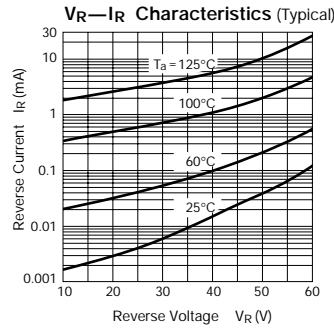
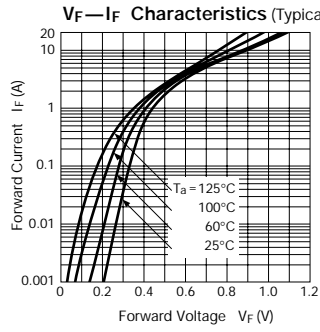
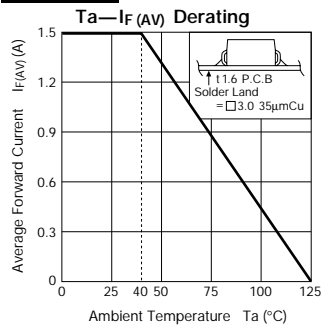

SFPB-66

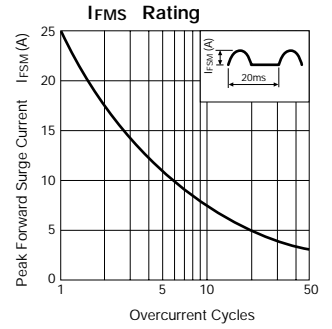
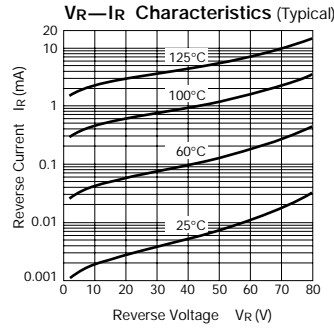
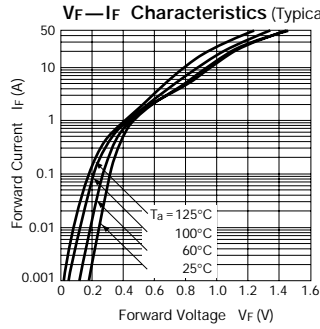
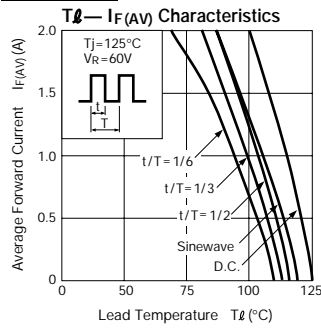

SFPB-69

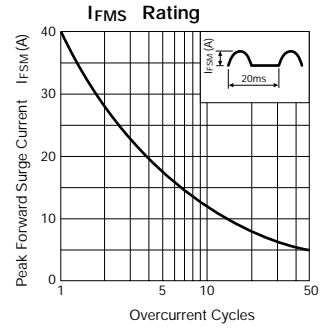
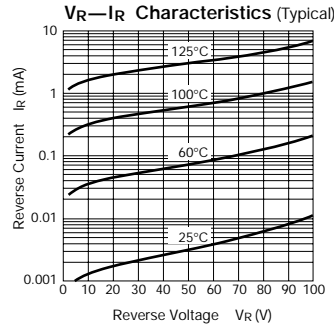
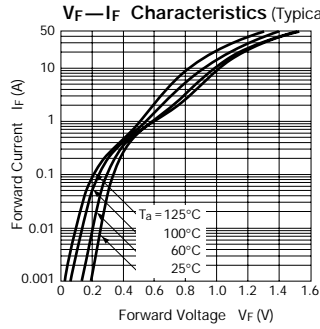
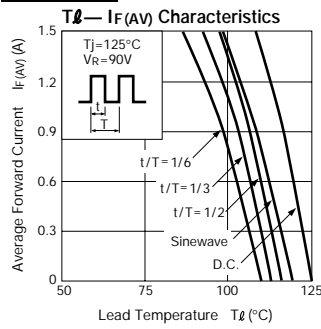

SFPB-74

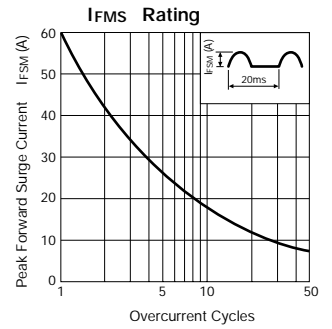
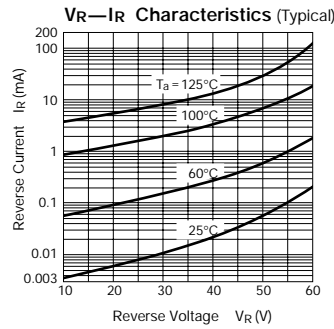
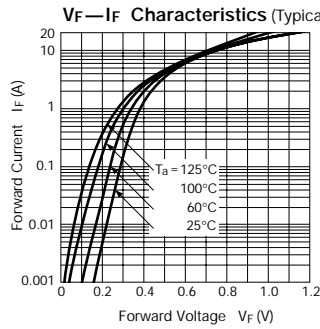
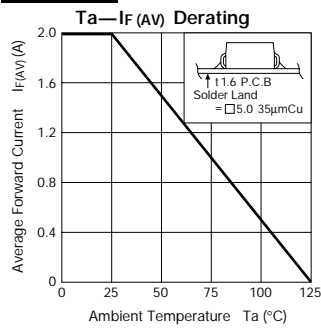

SFPB-76

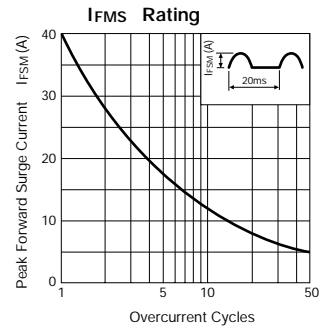
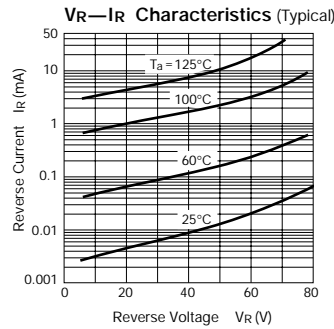
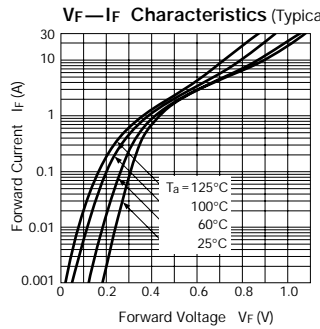
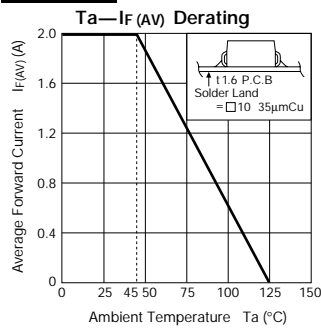

Characteristic Curves Schottky Barrier Diodes

SPB-G34S

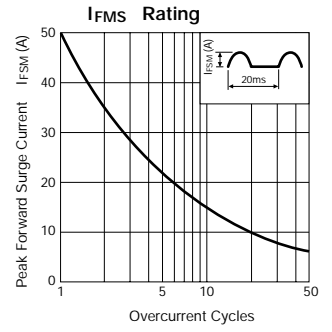
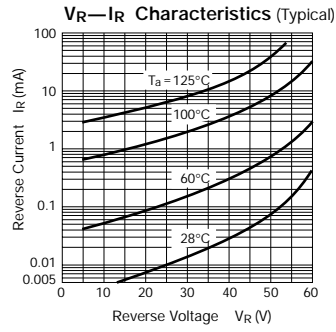
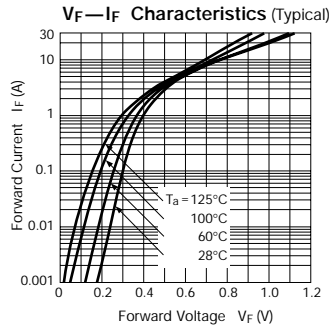
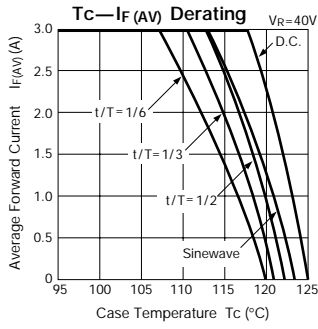

SPB-G54S

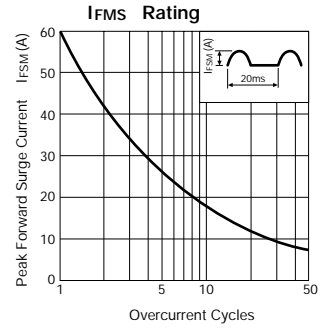
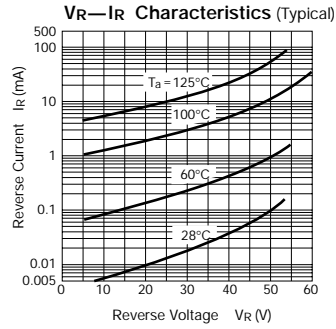
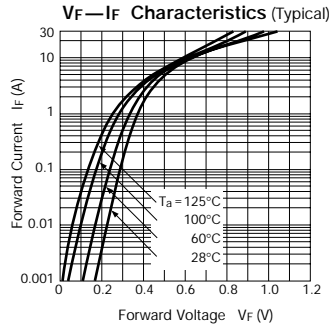
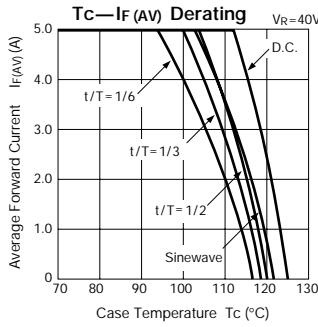

SPB-G56S

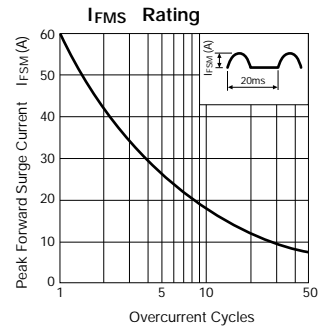
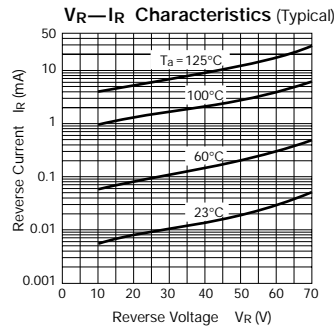
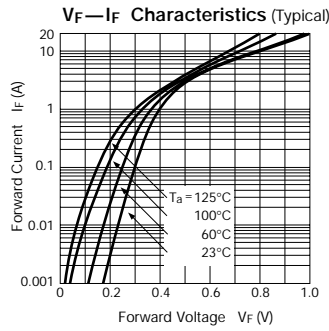
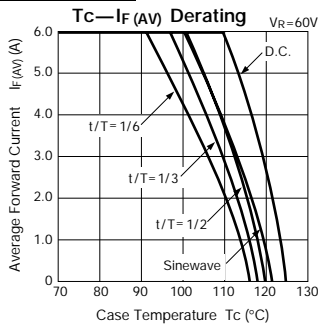

SPB-64S

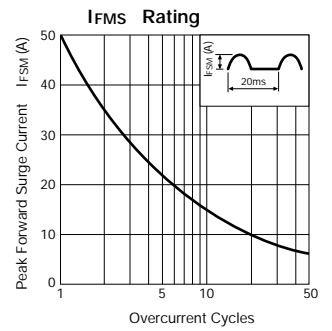
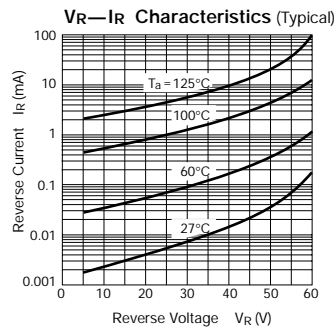
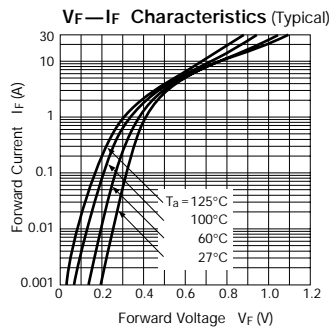
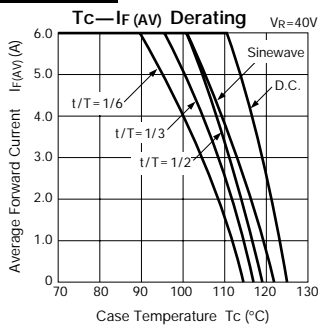

SPB-66S

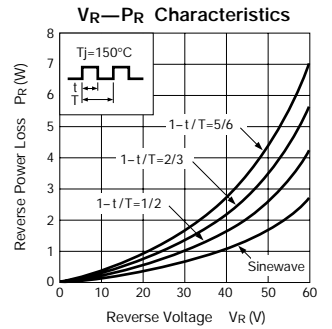
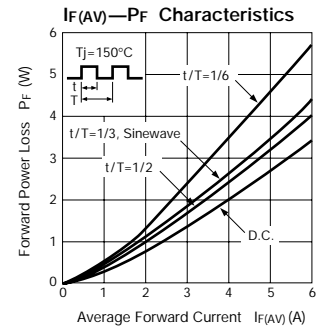
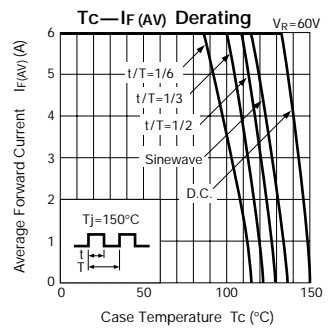
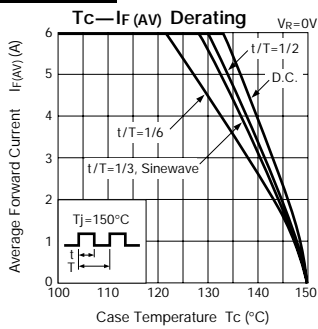

Characteristic Curves Schottky Barrier Diodes

MPE-24H

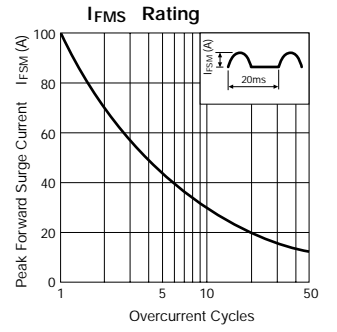
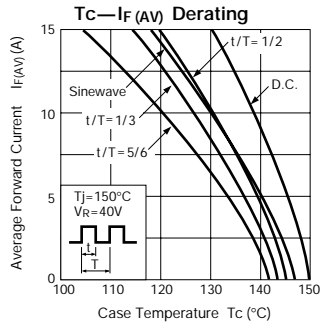

MPE-29G

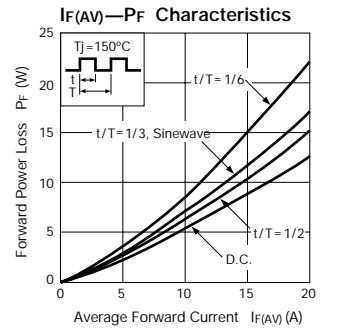
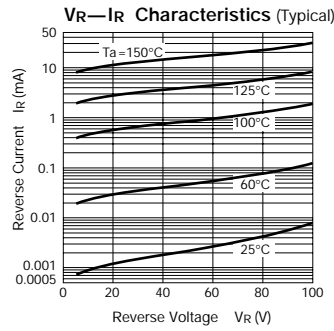
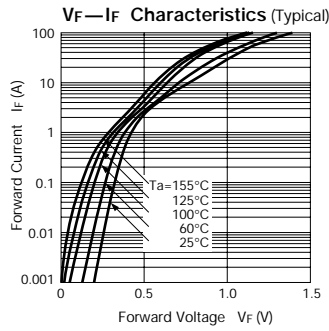
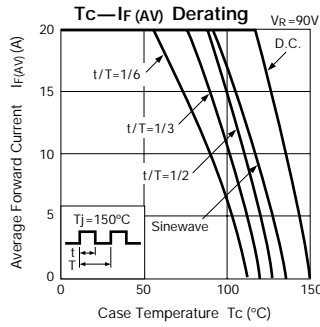

AK 03, 04

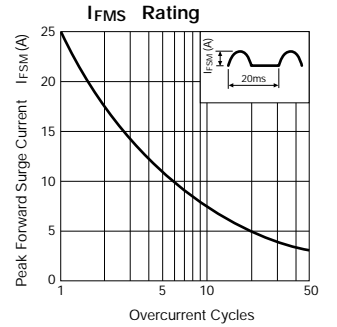
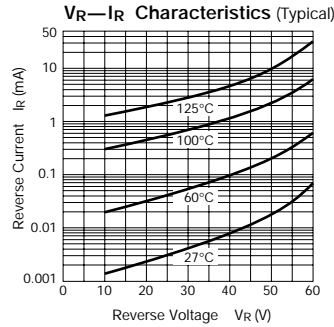
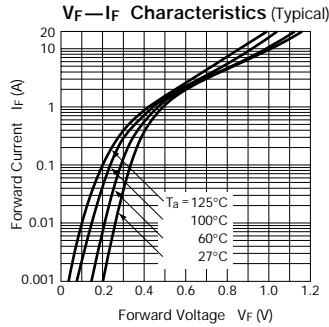
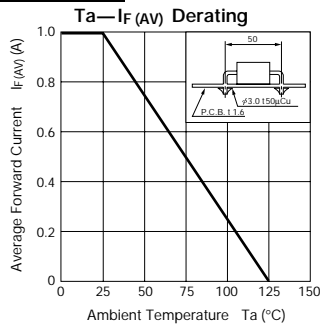

AK 06

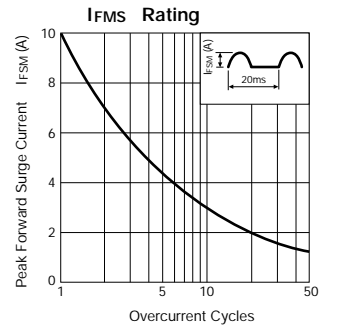
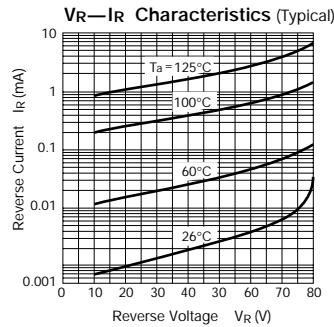
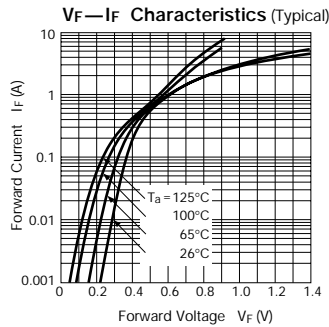
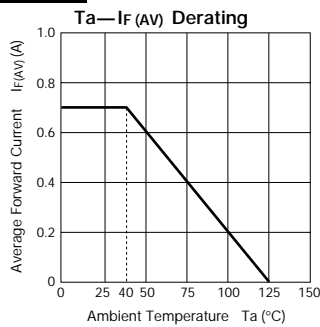

AK 09

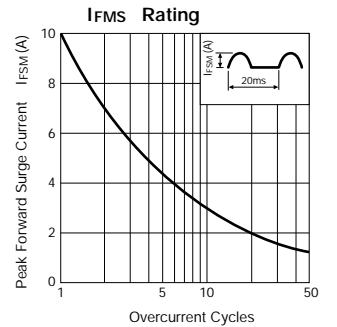
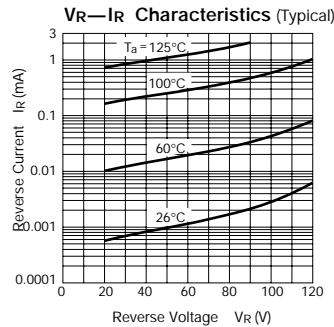
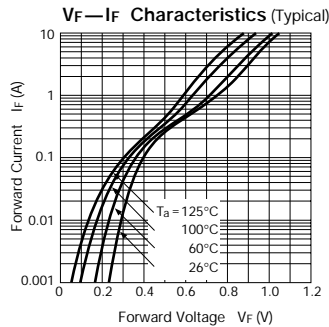
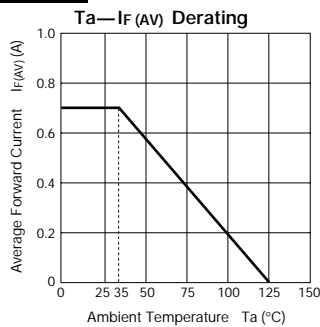

Characteristic Curves Schottky Barrier Diodes

EK 03, 04

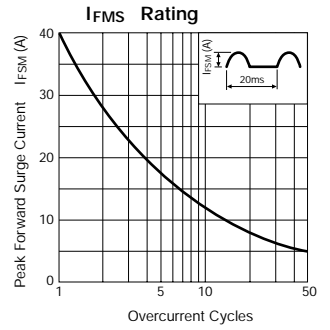
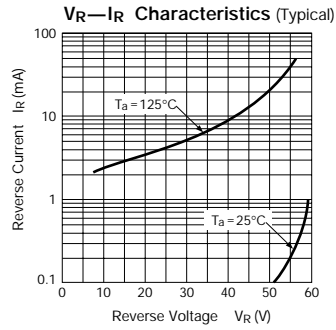
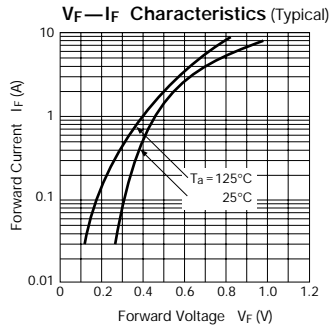
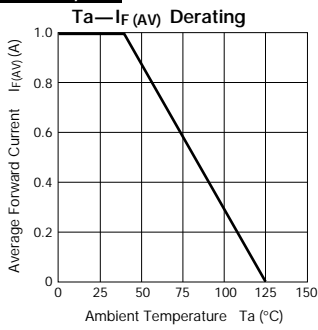

EK 06

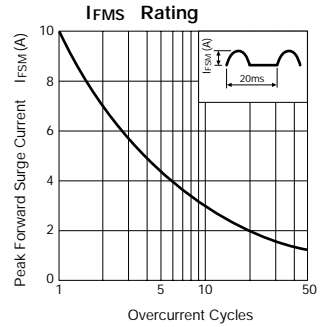
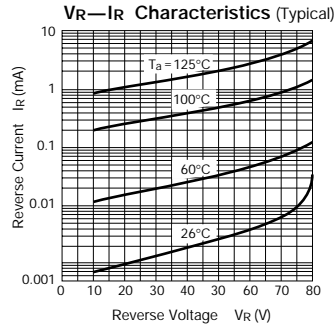
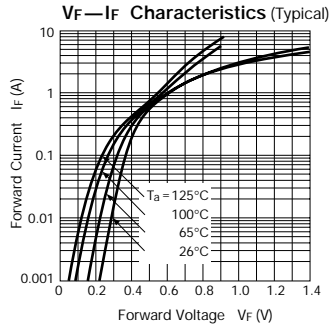
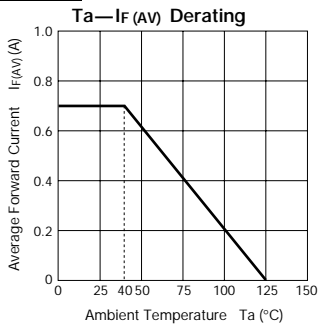

EK 09

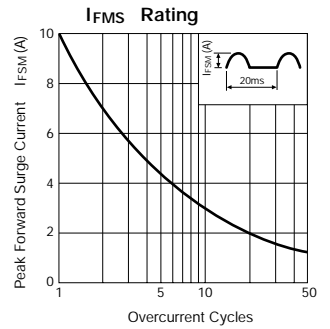
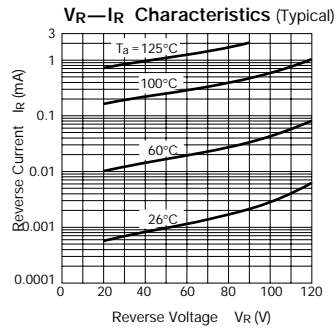
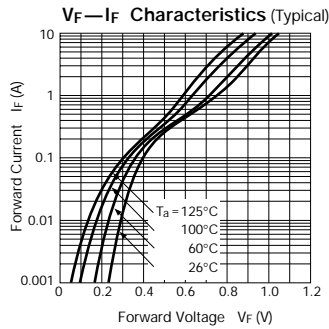
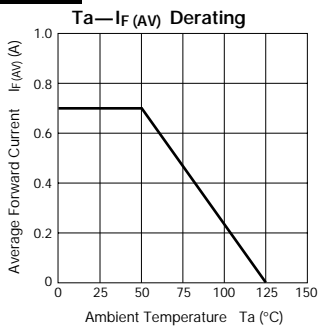

EK 13, 14

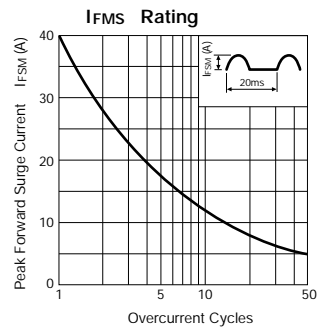
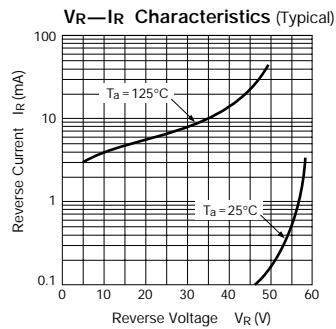
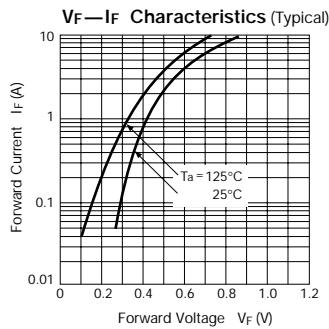
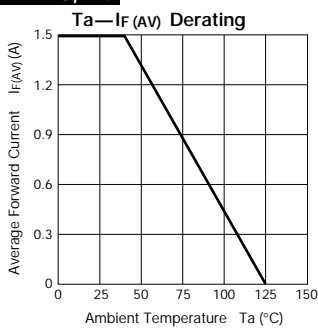

EK 16

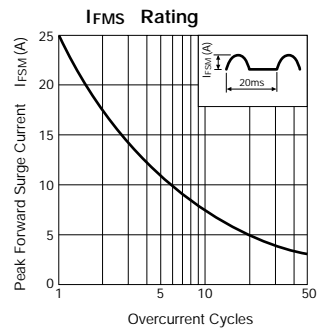
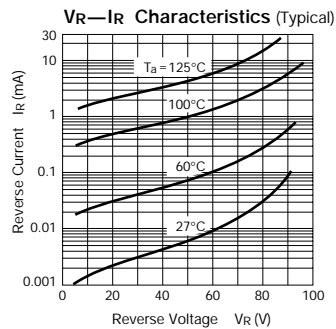
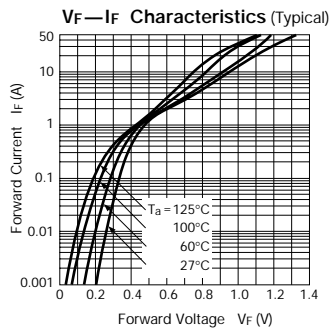
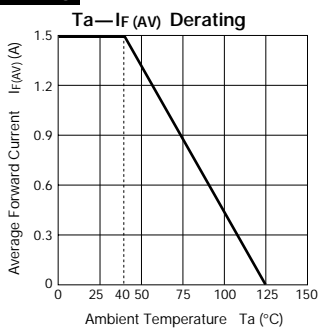

Characteristic Curves Schottky Barrier Diodes

EK 19

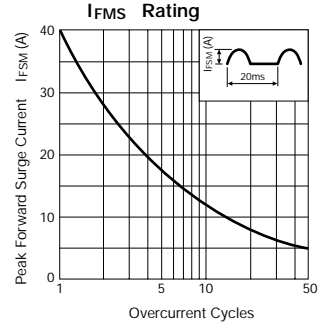
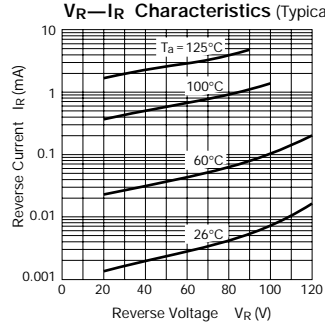
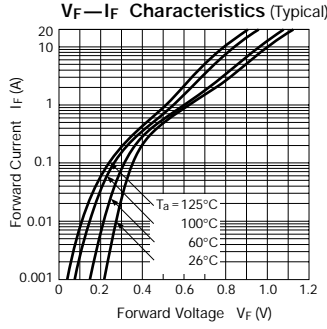
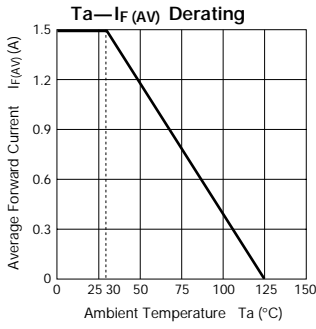

RK 13, 14

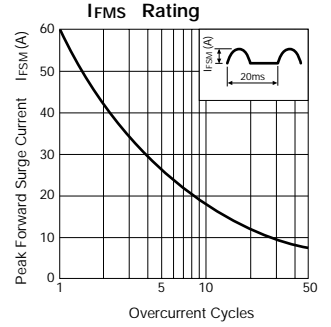
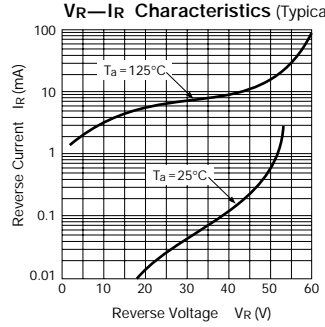
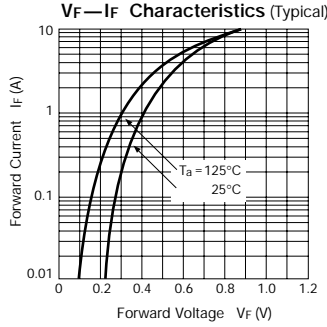
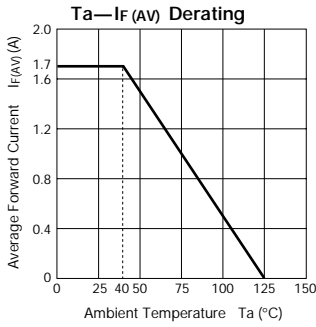

RK 16

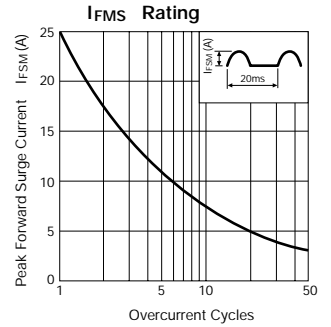
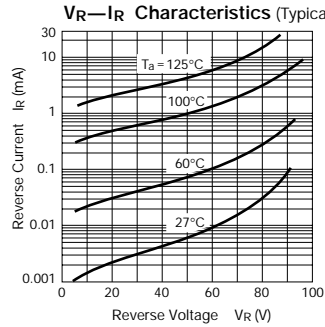
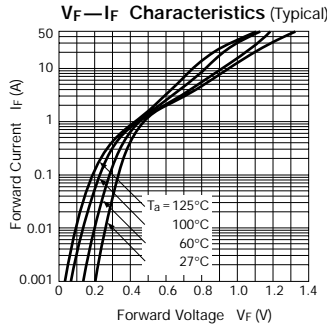
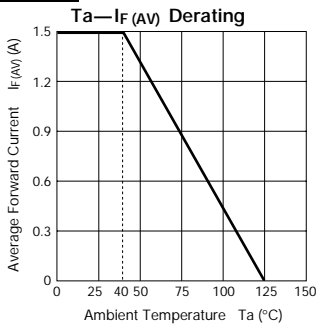

RK 19

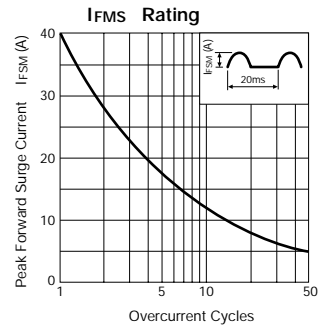
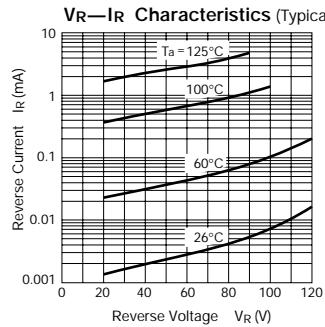
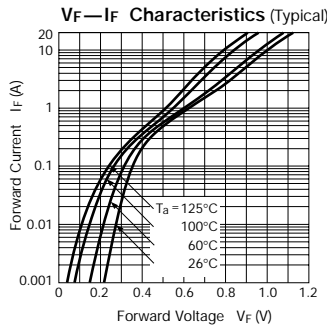
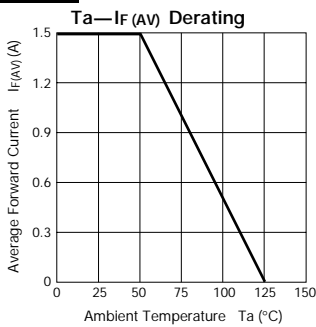

RK 33, 34

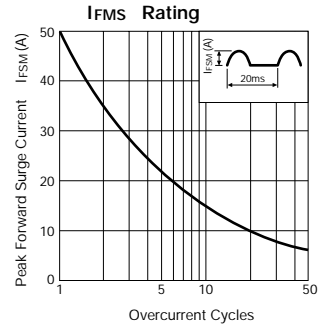
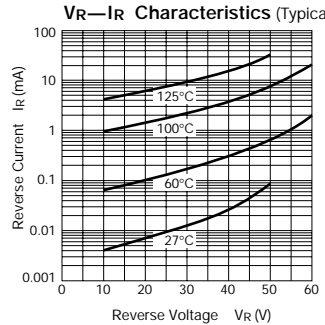
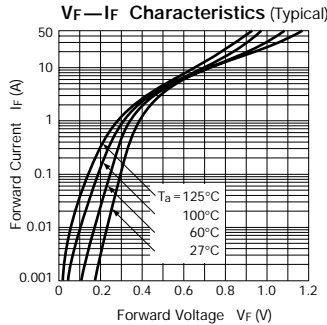
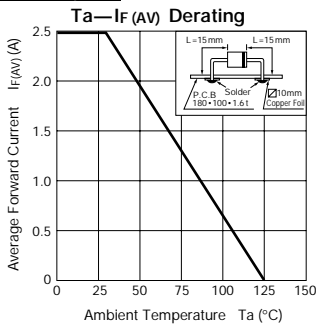

Characteristic Curves Schottky Barrier Diodes

RK 36

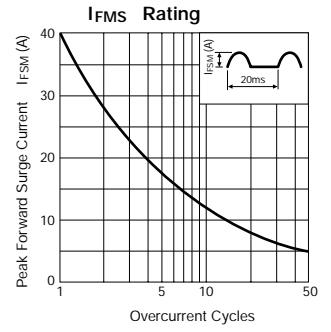
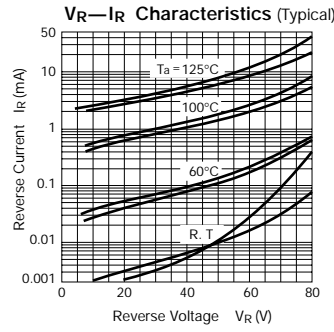
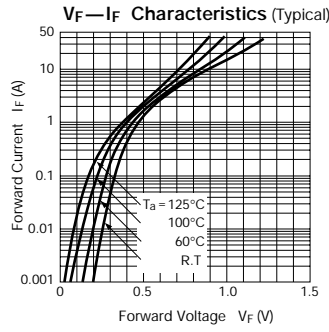
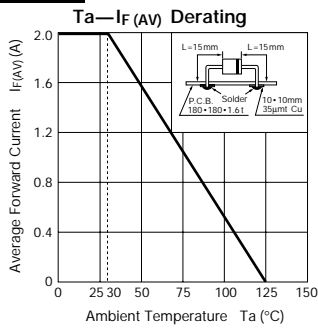

RK 39

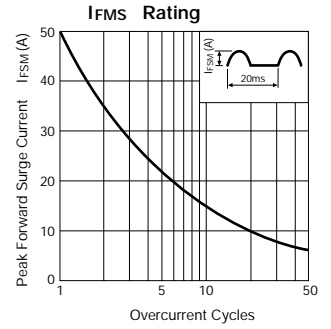
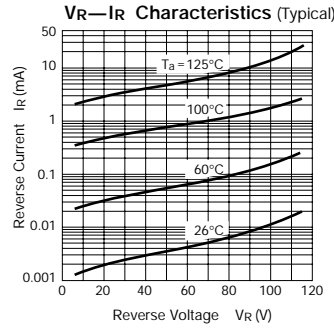
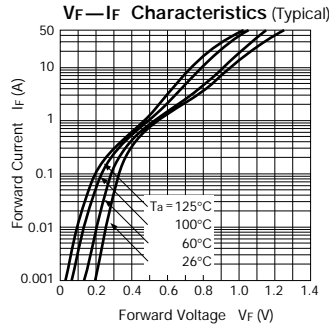
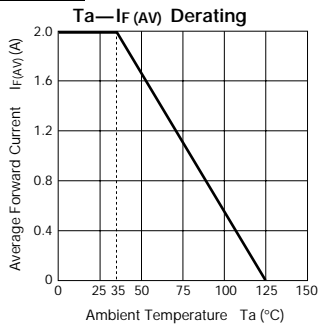

RK 43, 44

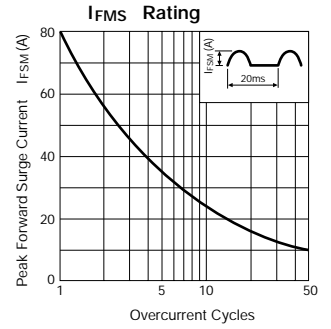
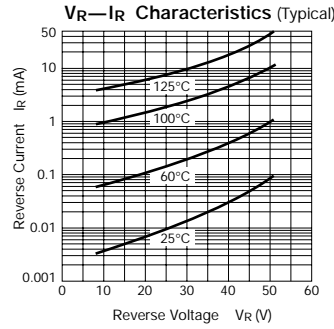
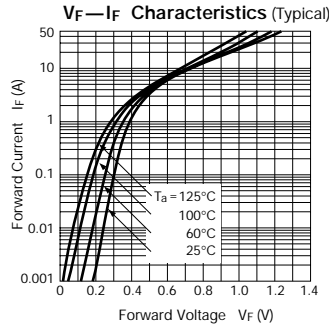
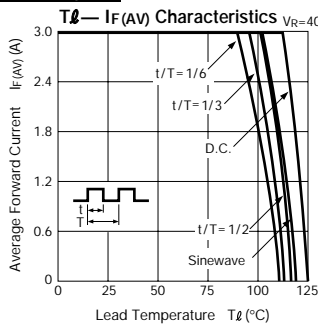

RK 46

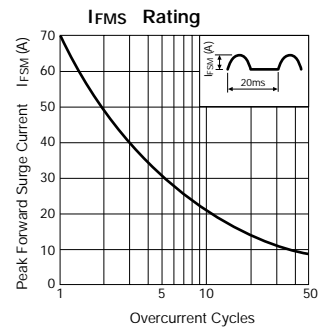
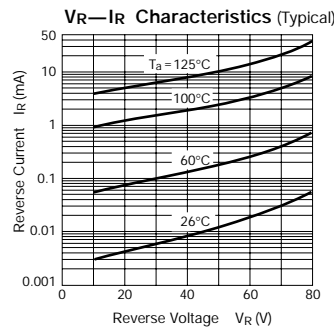
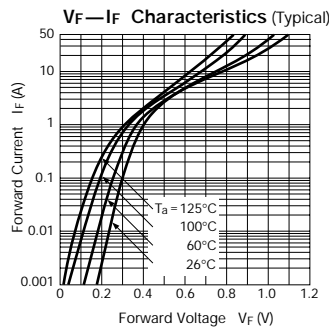
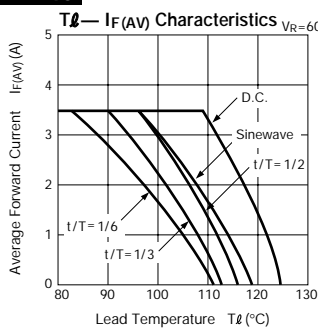

RK 49

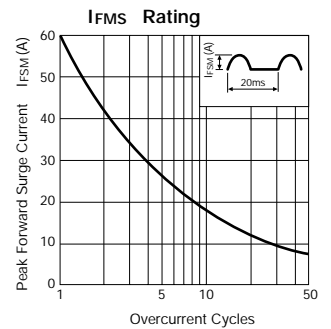
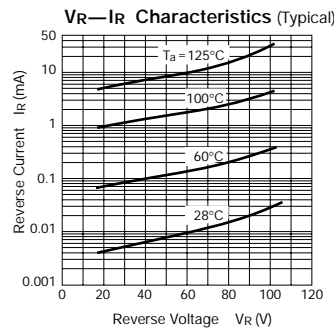
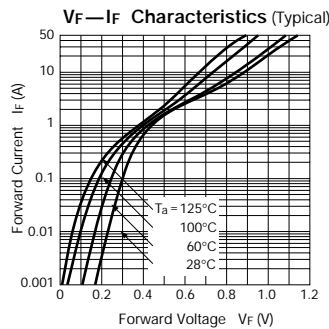
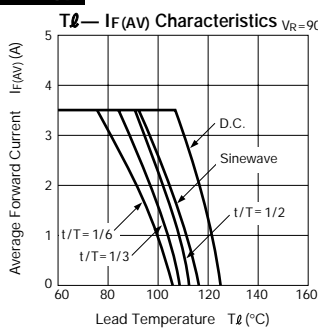

Characteristic Curves Schottky Barrier Diodes

FMB-G14

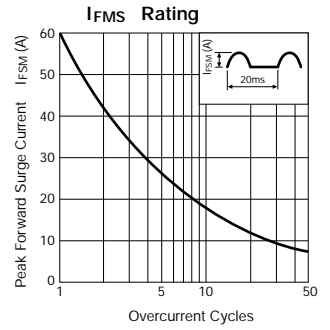
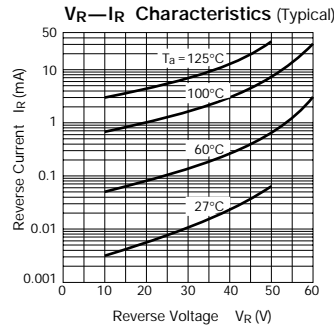
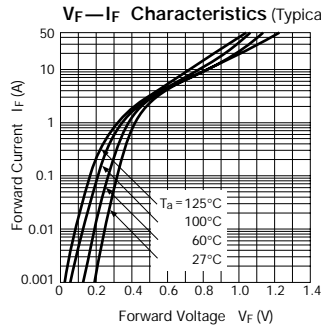
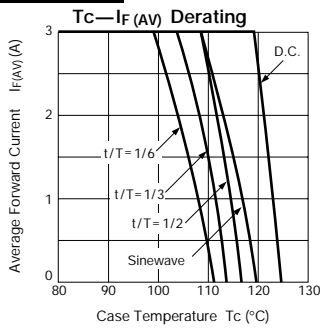

FMB-G14L

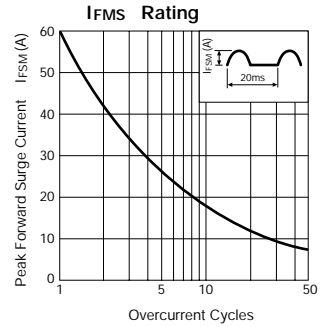
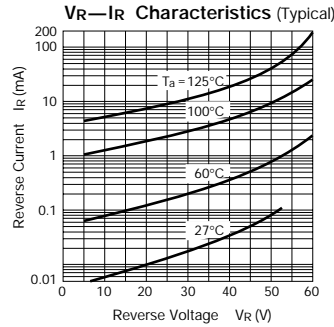
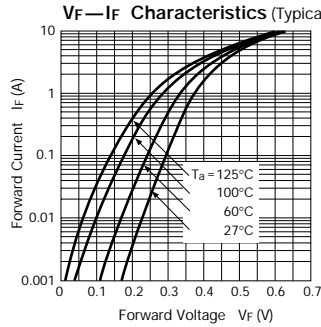
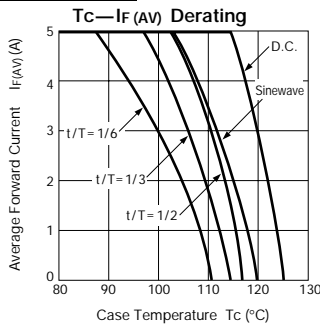

FMB-G16L

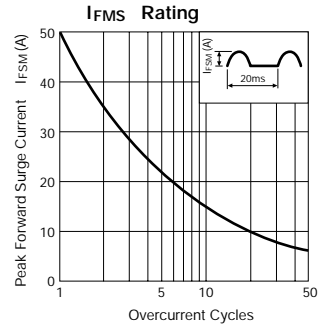
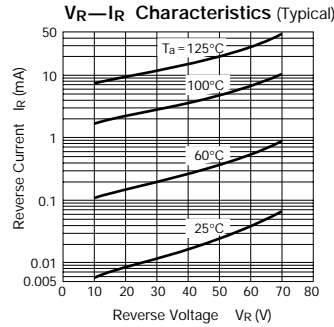
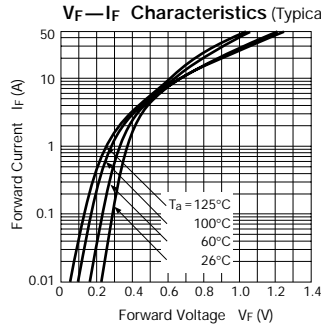
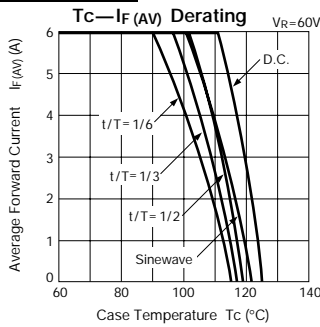

FMB-G19L

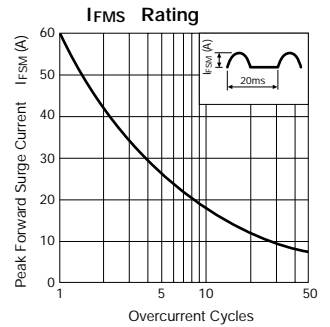
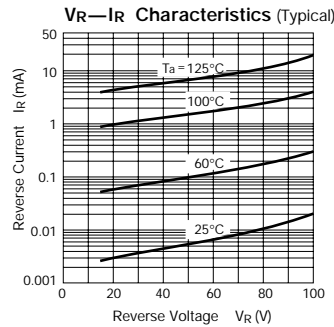
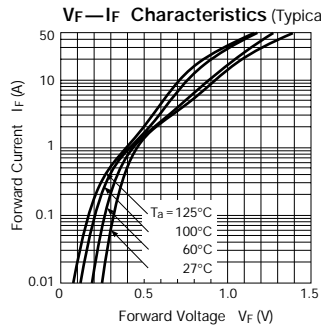
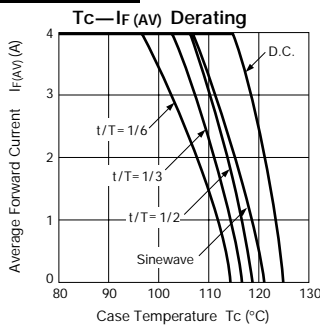

FMB-G24H

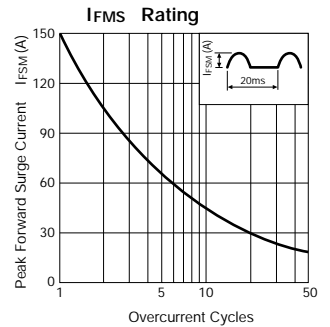
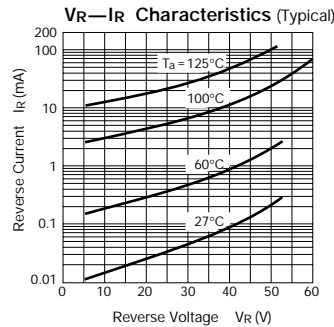
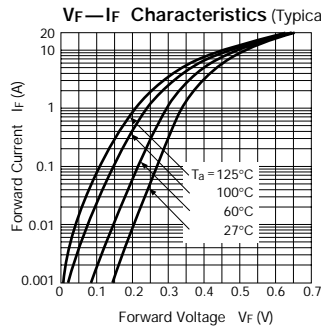
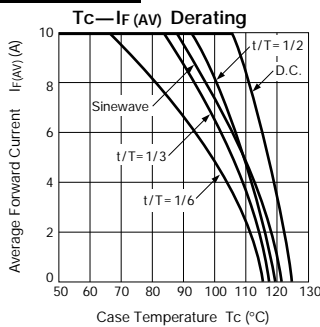

Characteristic Curves Schottky Barrier Diodes

FMB-24

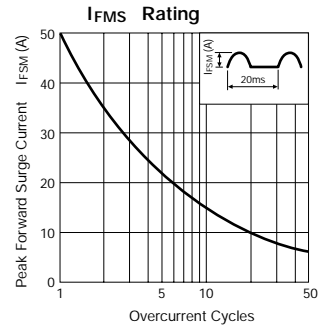
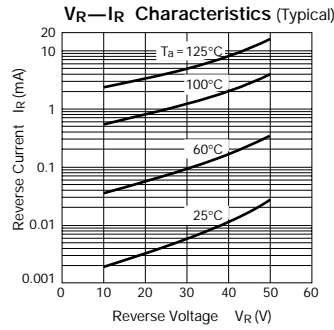
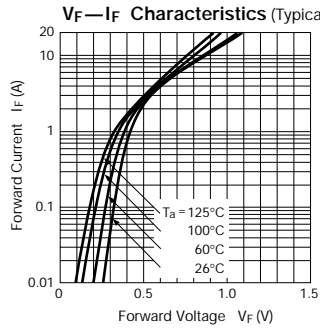
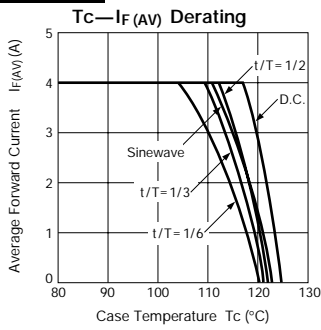

FMB-24H

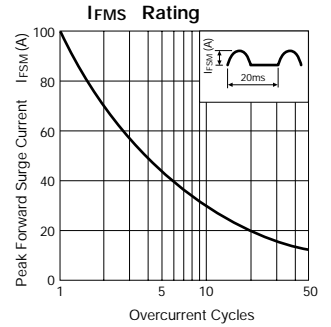
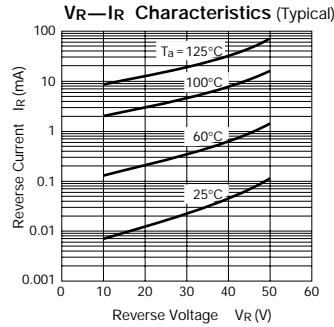
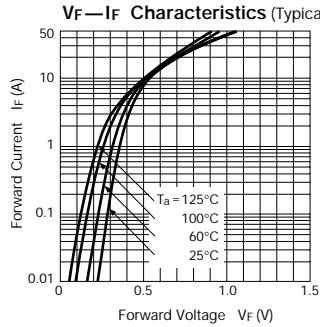
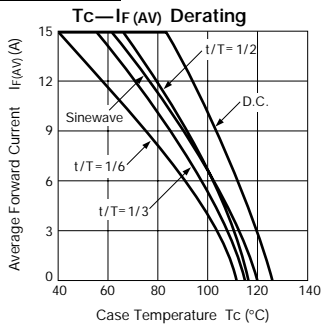

FMW-24H

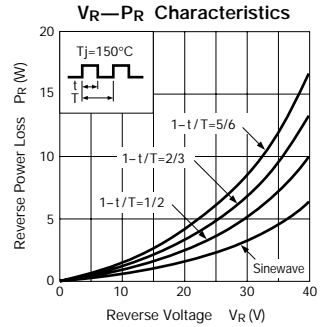
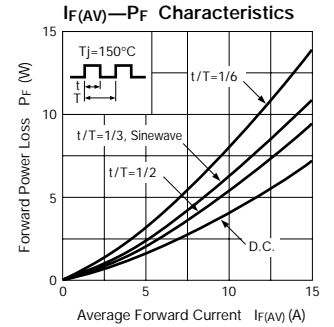
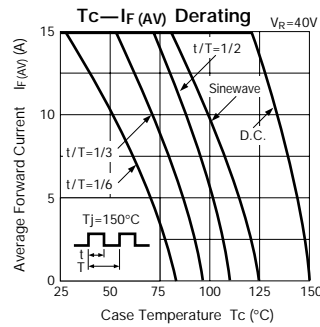
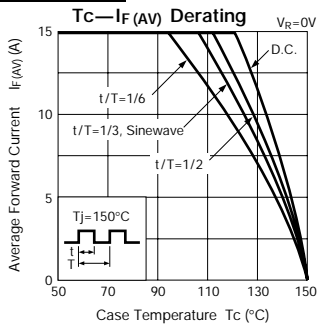

FMB-24L

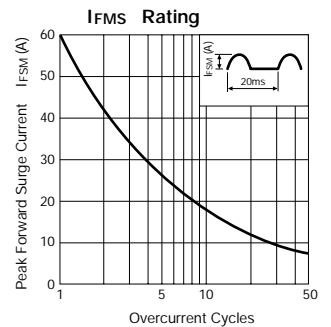
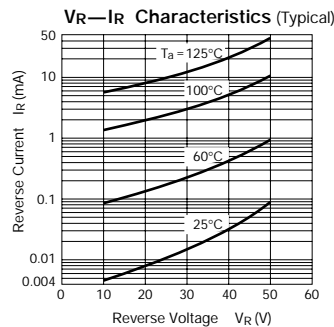
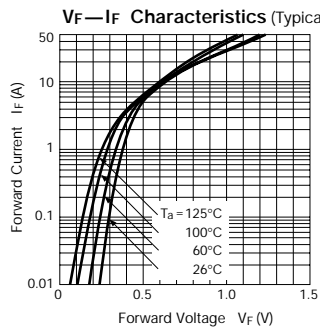
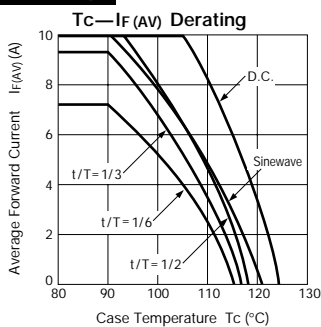

FMW-24L

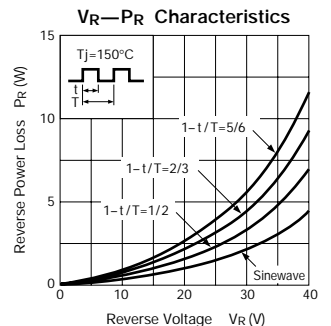
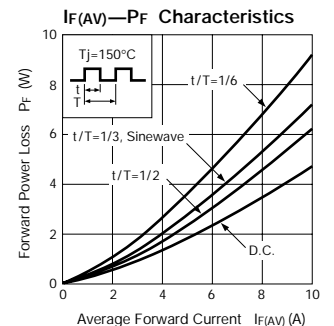
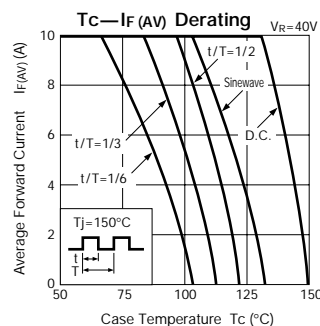
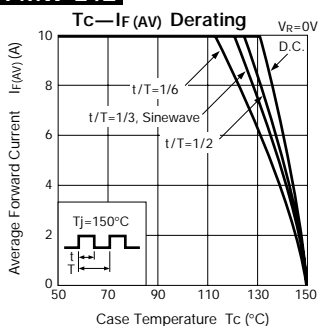

Characteristic Curves Schottky Barrier Diodes

FMB-24M

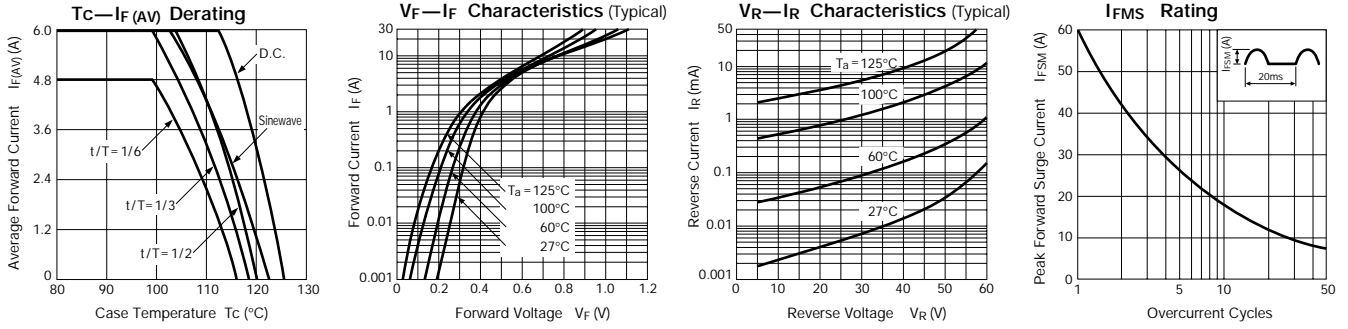

FMB-2304

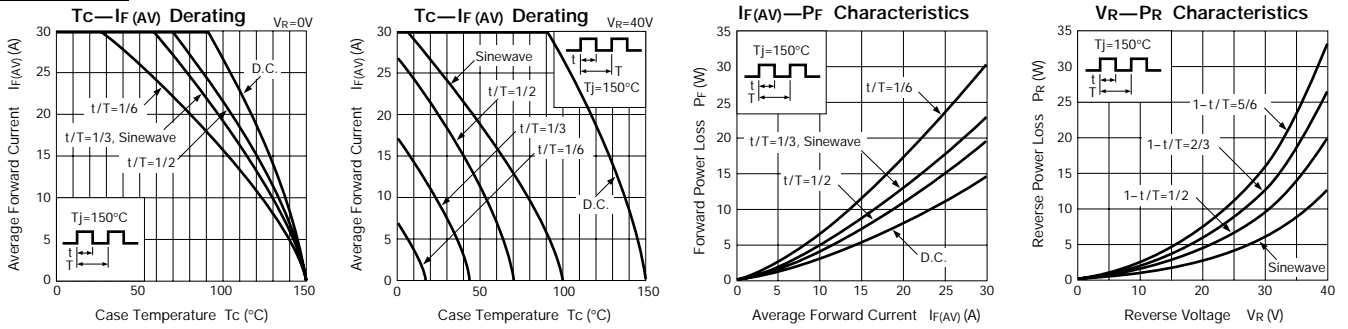

FMB-26

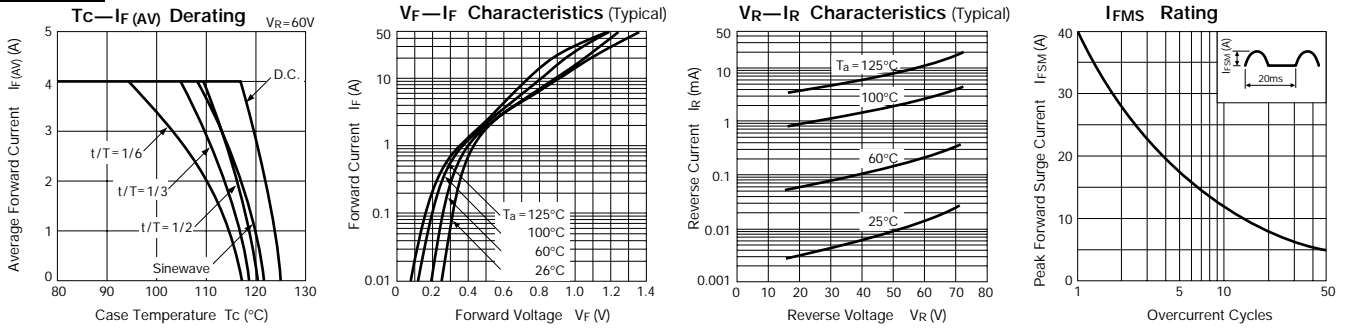

FMB-26L

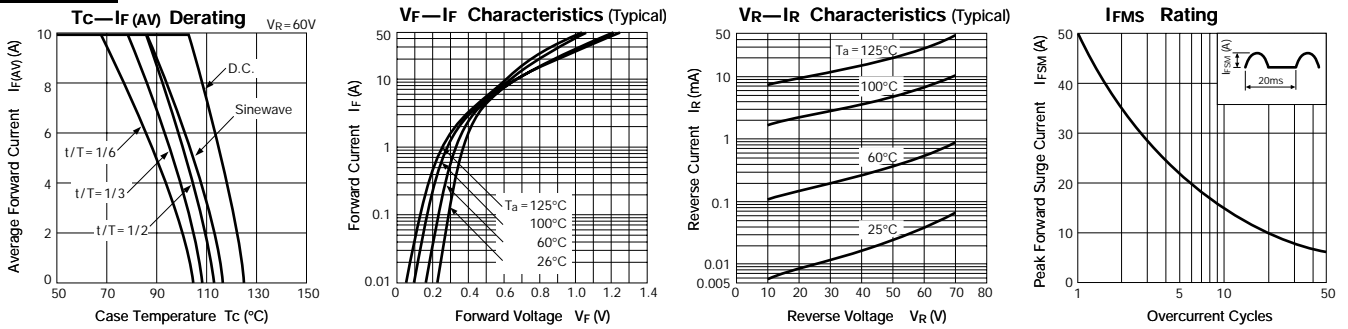

FMB-2206

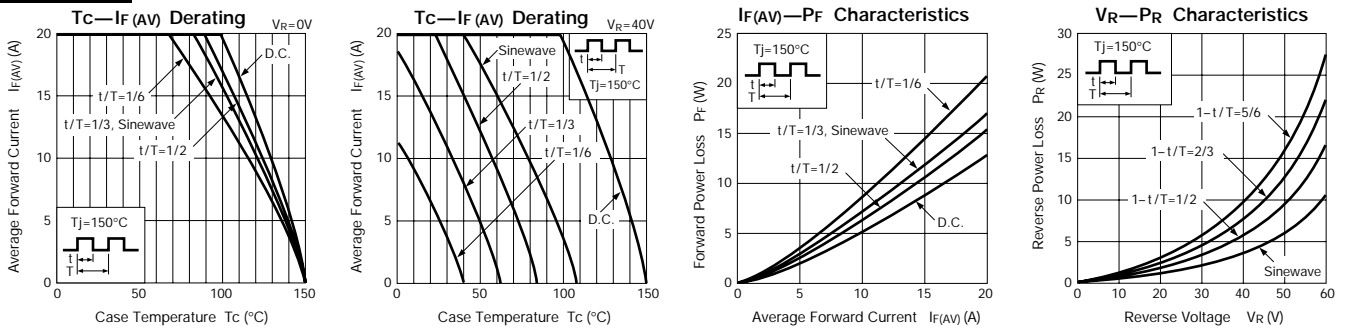

Characteristic Curves Schottky Barrier Diodes

FMB-2306

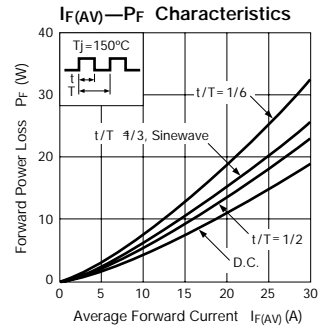
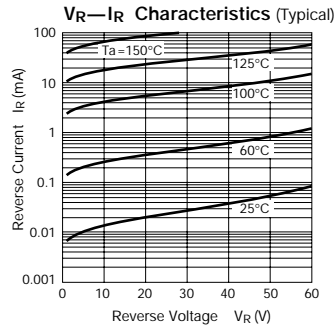
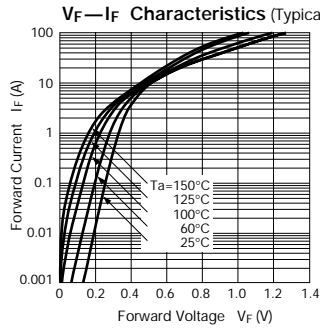
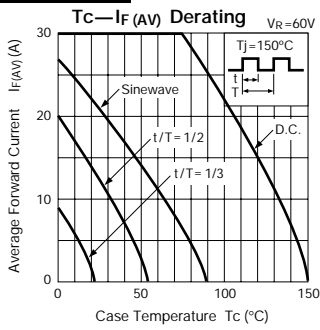

FMB-29

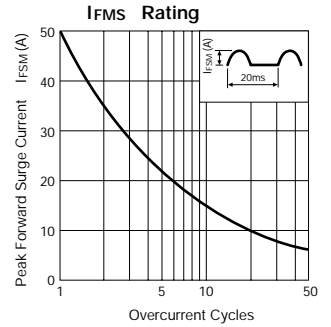
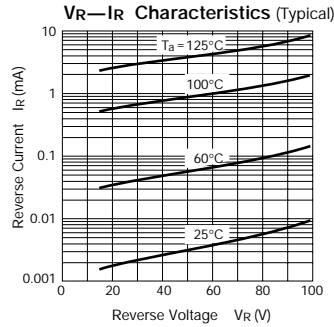
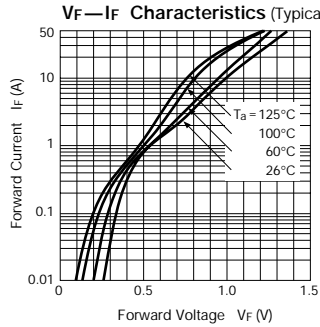
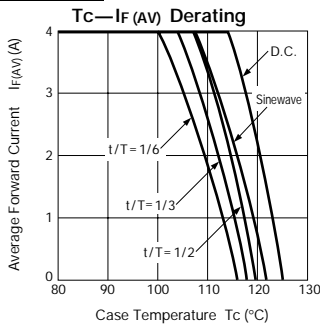

FMB-29L

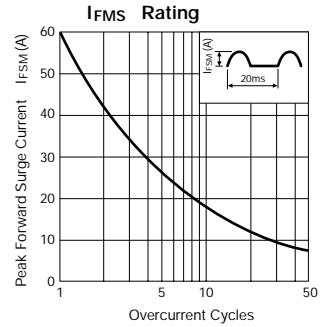
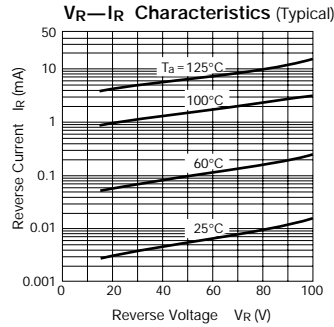
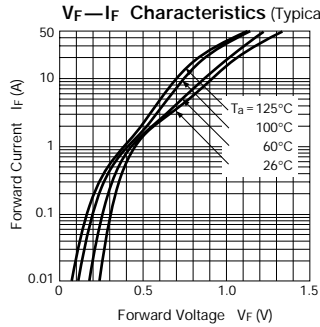
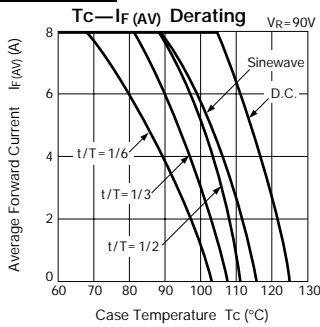

FME-24H

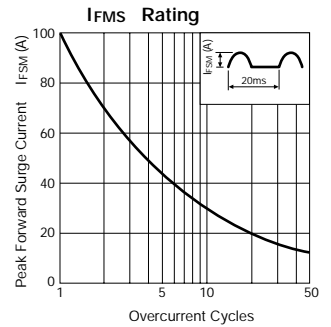
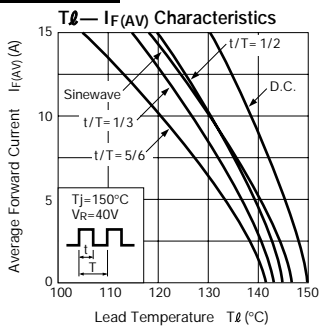

FME-2104

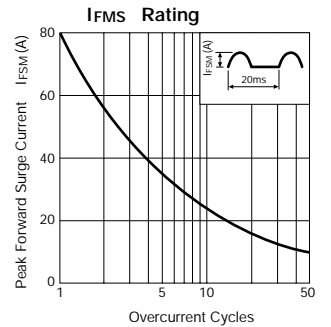
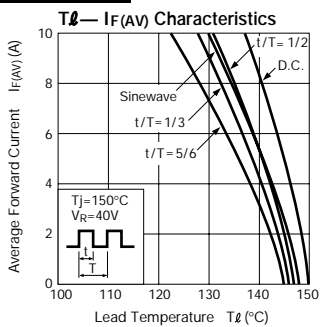

Characteristic Curves Schottky Barrier Diodes

FME-220A

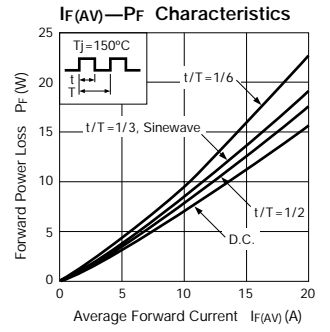
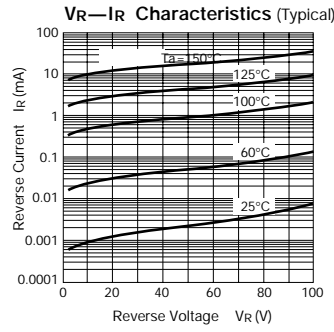
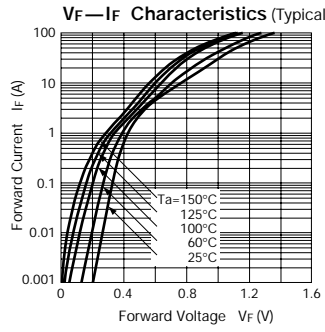
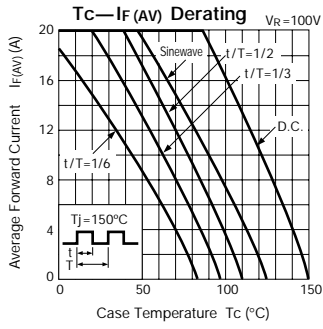

FME-230A

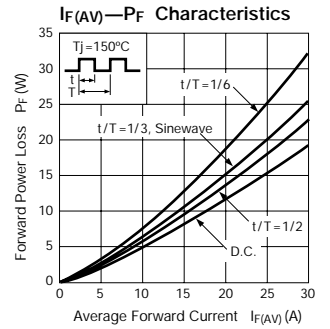
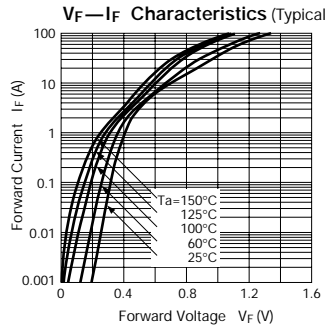
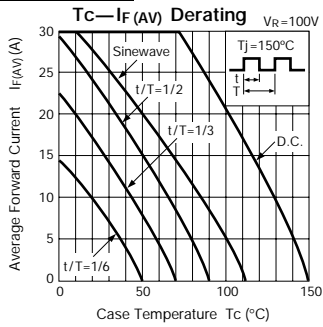

FMJ-23L

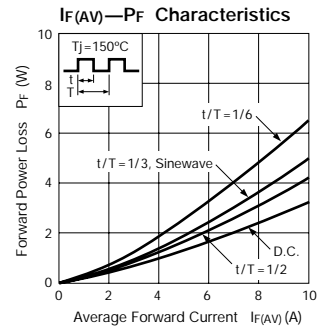
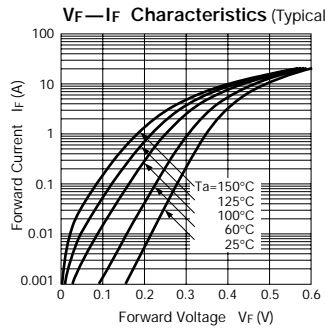
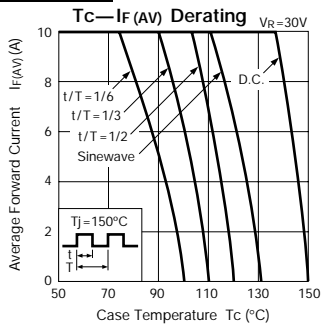

FMB-34

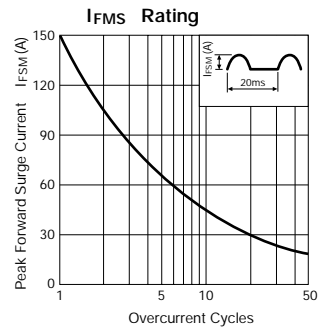
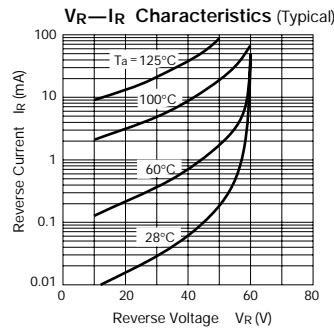
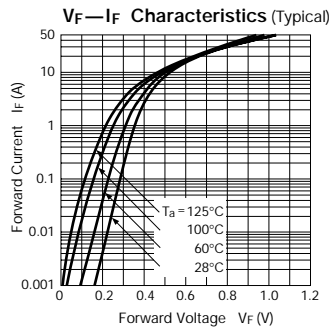
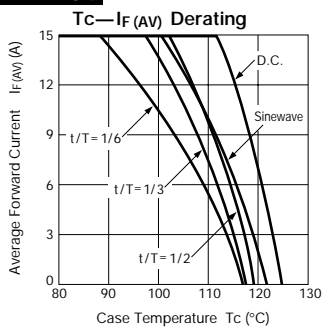

FMB-34M

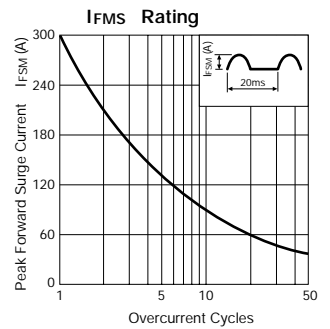
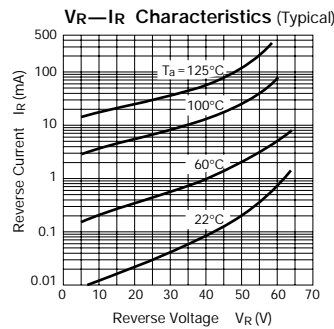
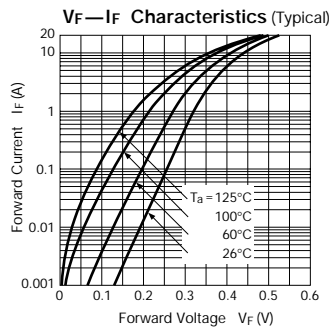
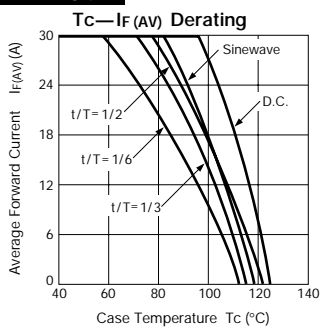

Characteristic Curves Schottky Barrier Diodes

FMB-34S

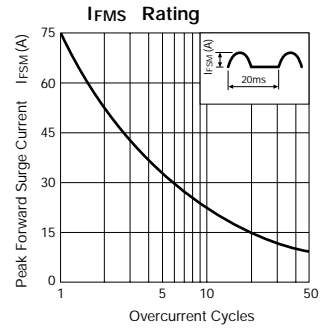
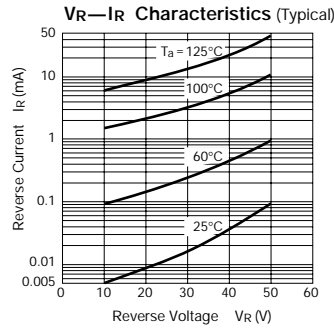
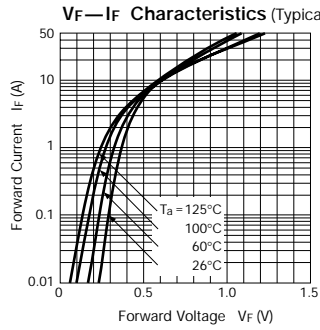
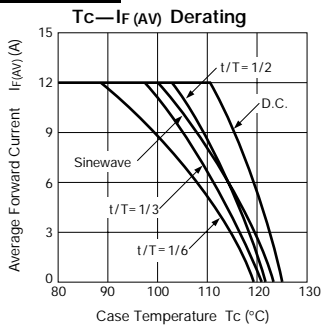

FMB-36

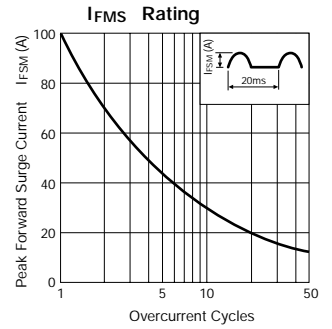
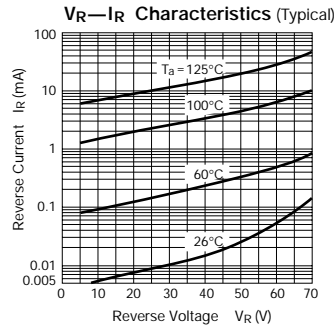
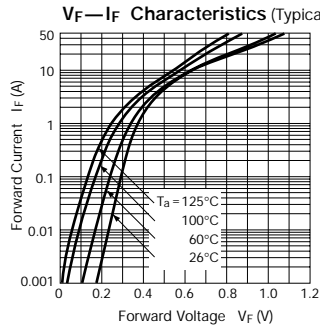
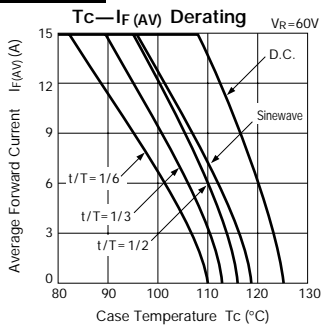

FMB-36M

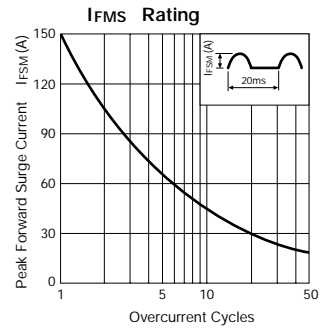
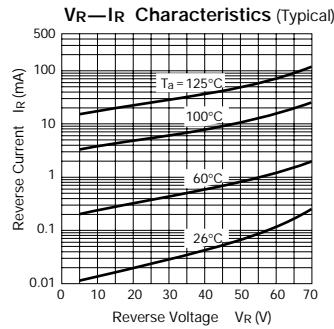
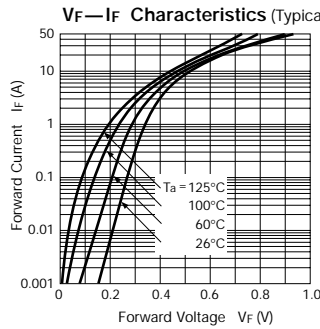
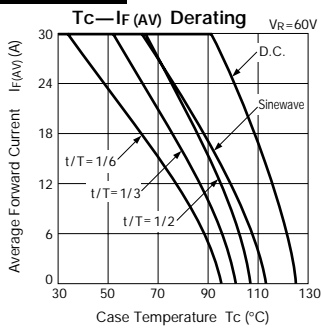

FMB-39

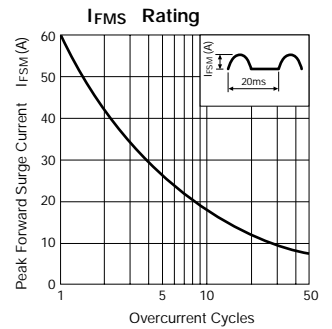
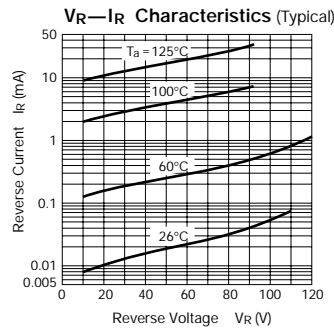
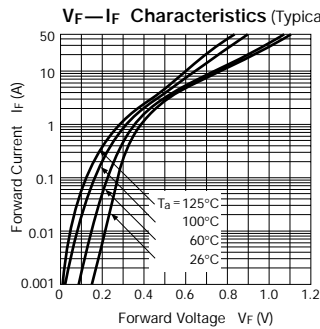
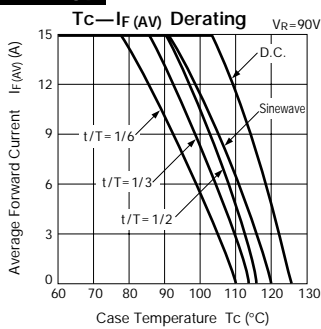

FMB-39M

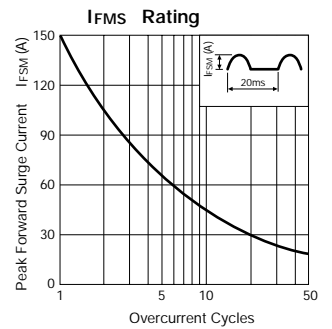
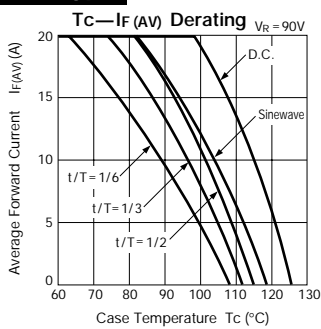

Schottky Barrier Diodes

RBV-406B

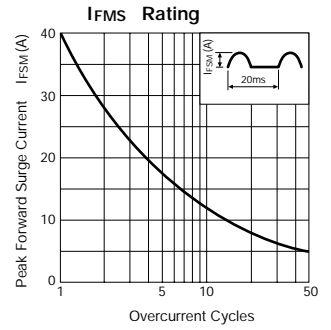
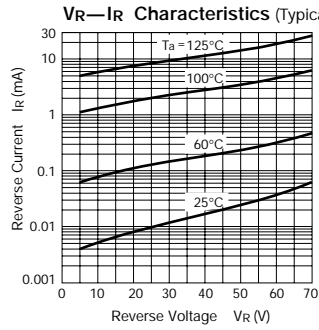
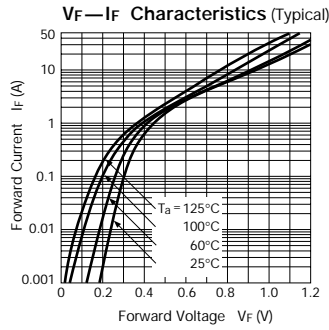
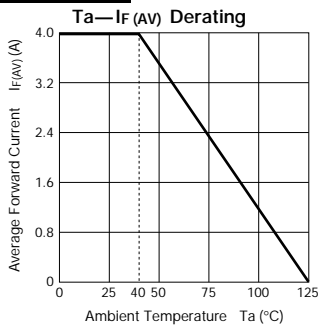

SFPW-56

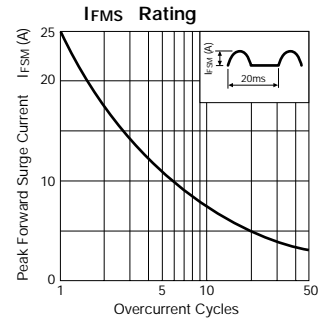
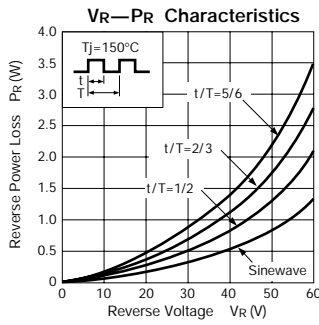
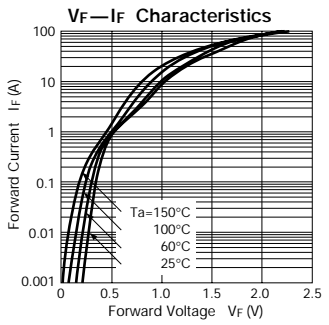
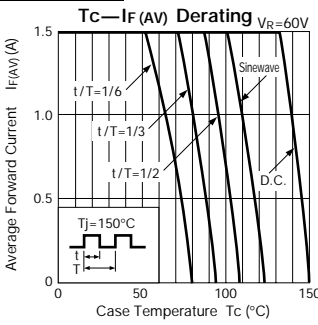

FME-2106

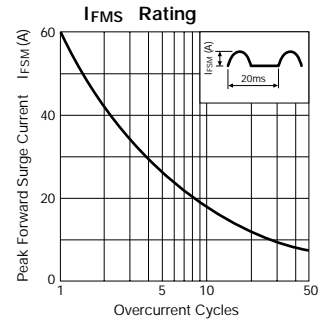
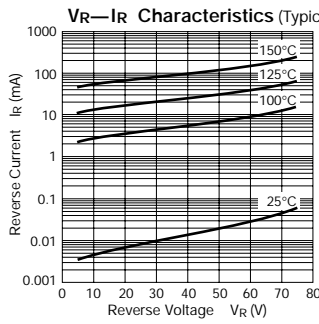
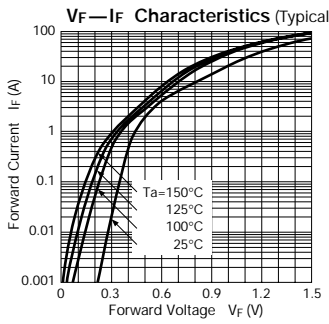
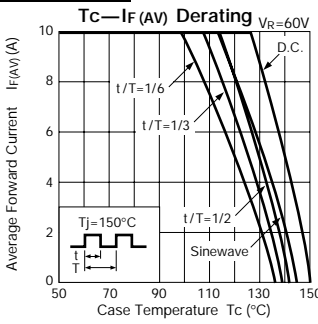

Characteristic Curves Damper Diodes

RH 10F, 2D, 2F

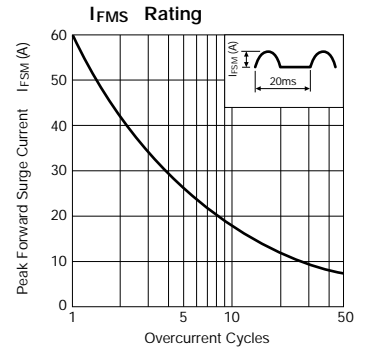
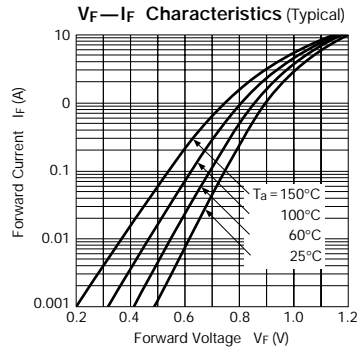
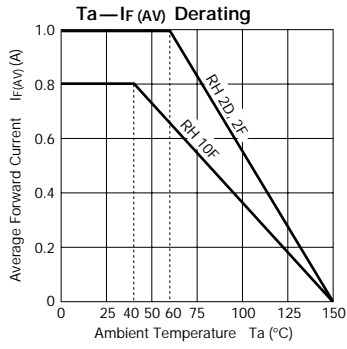

RH 3F, 3G

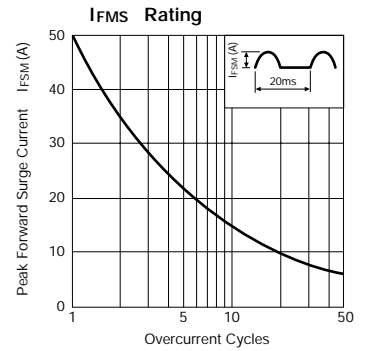
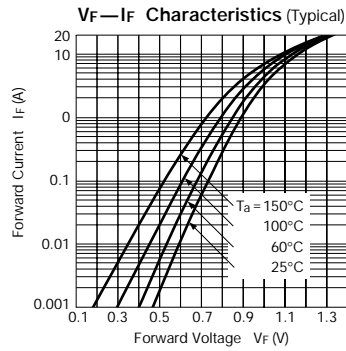
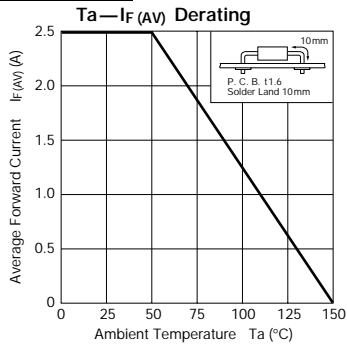

RP 3F

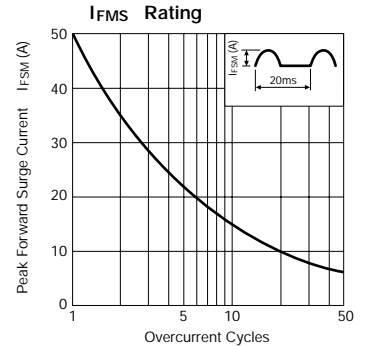
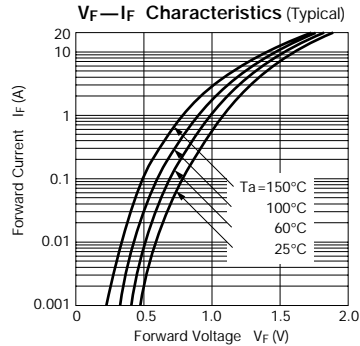
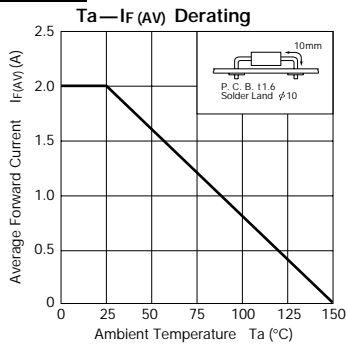

RS 3FS

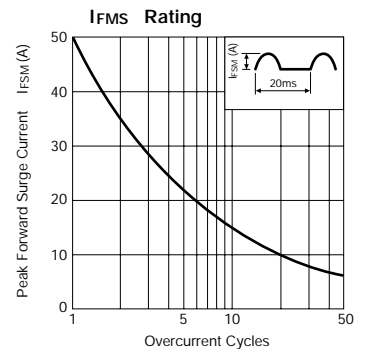
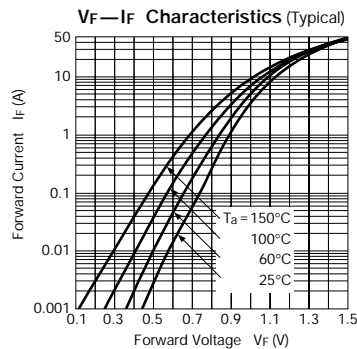
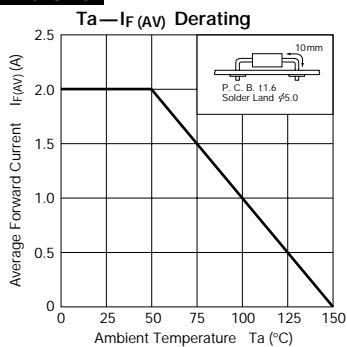

RH 4F

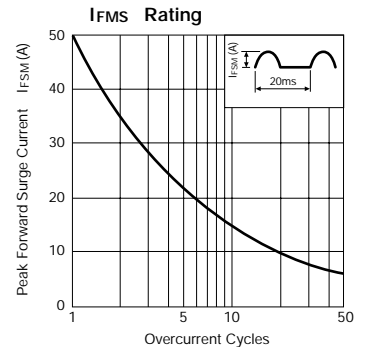
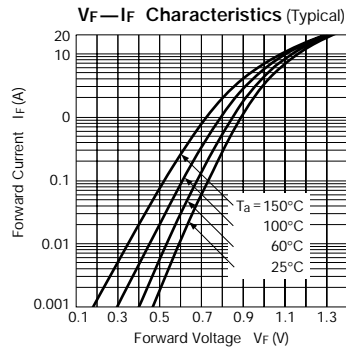
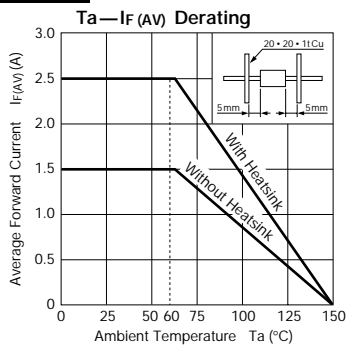

Characteristic Curves Damper Diodes

RS 4FS

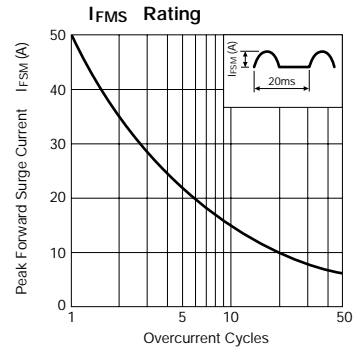
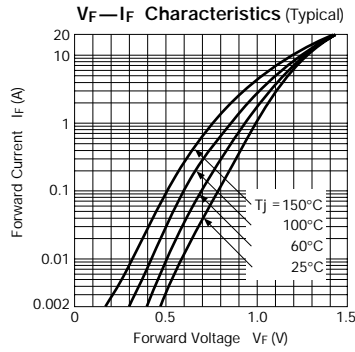
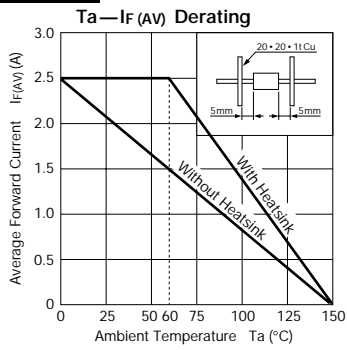

RU 4D

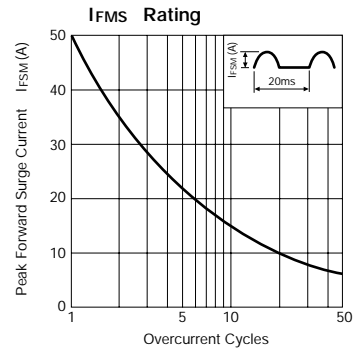
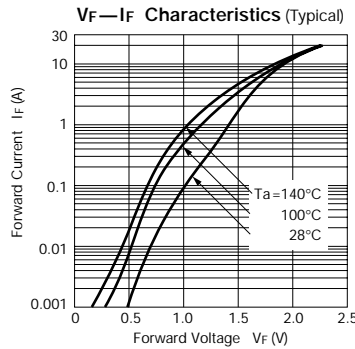
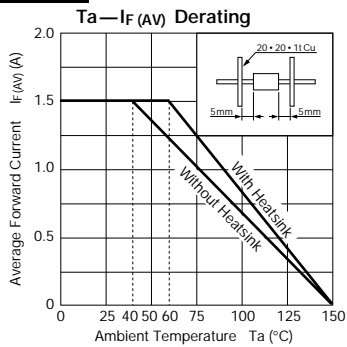

RU 4DS

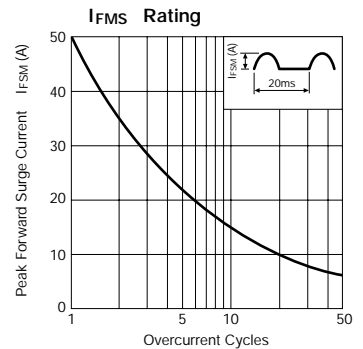
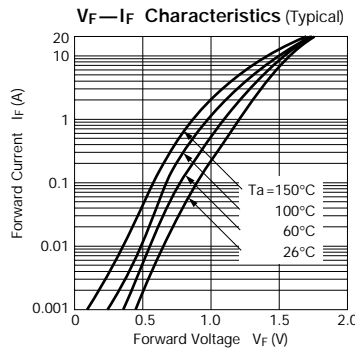
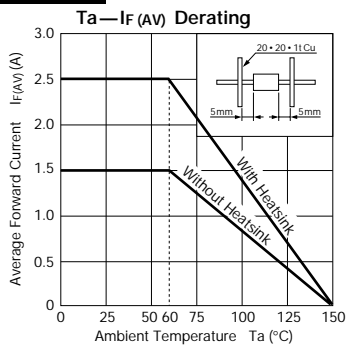

RG 2A2

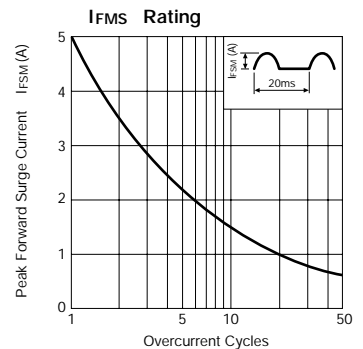
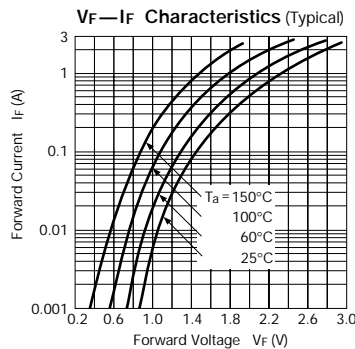
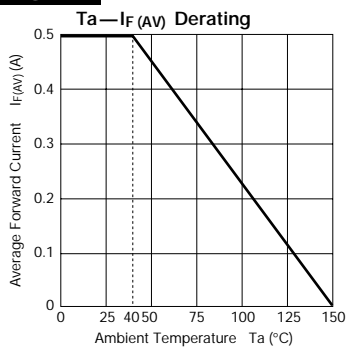

RC 3B2

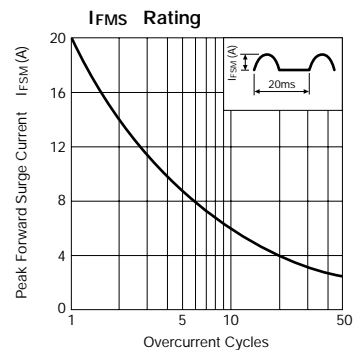
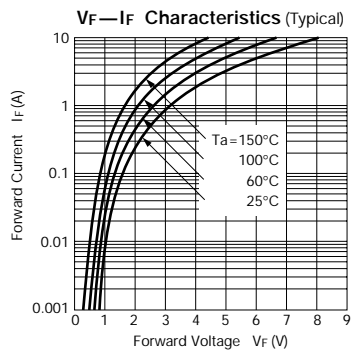
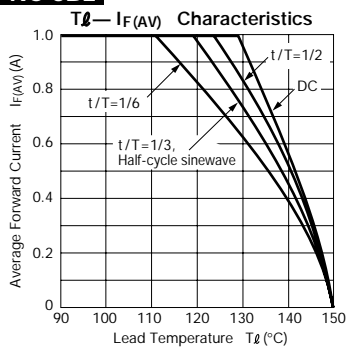

Characteristic Curves Damper Diodes

FMQ-G1FS

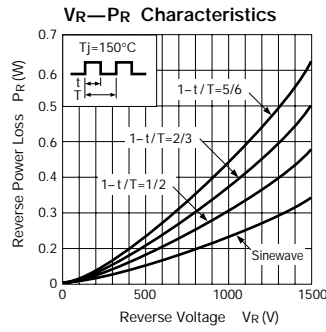
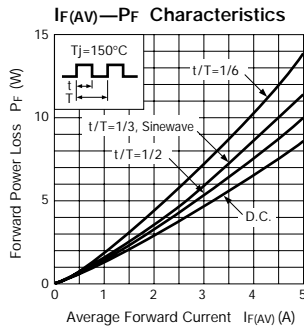
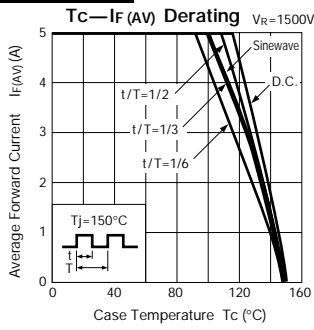

FMQ-G2FLS

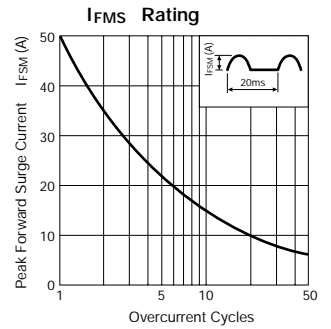
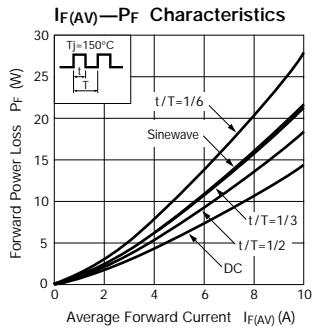
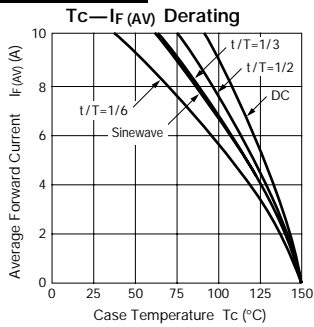

FMQ-G2FMS

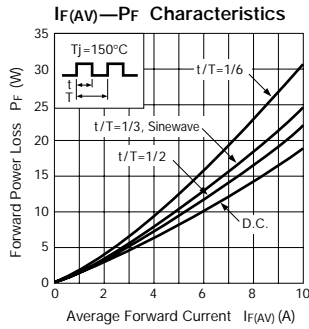
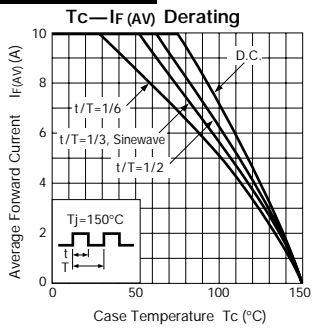

FMQ-G2FS

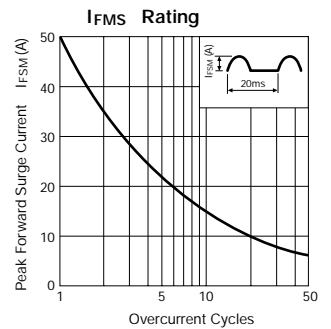
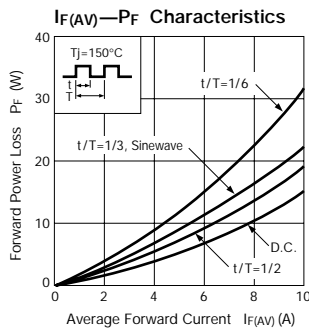
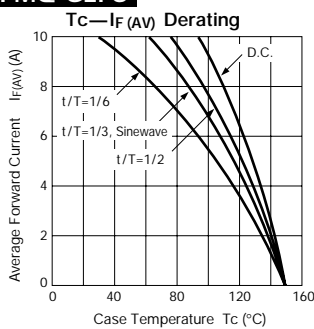

FMV-G2GS

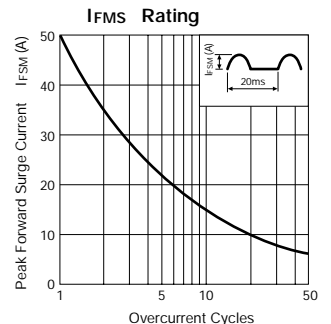
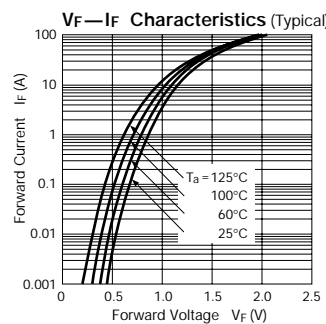
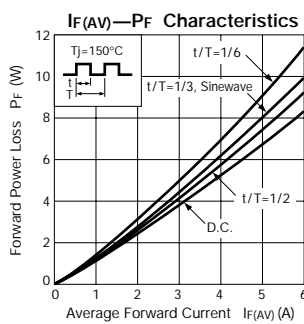
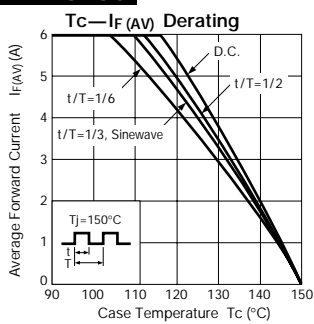

Characteristic Curves Damper Diodes

FMU-G2FS

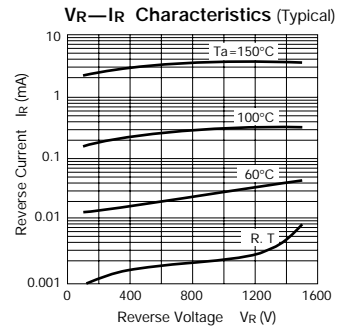
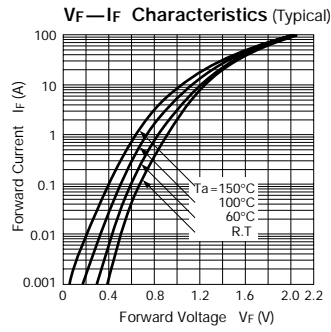
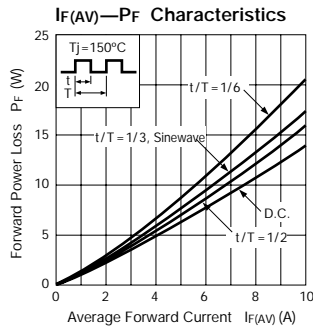
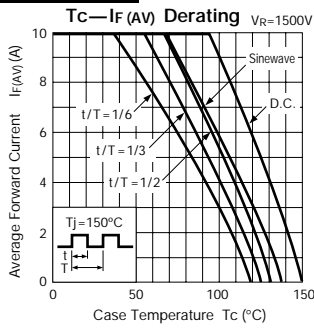

FMP-G5HS

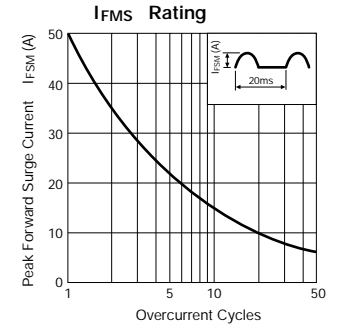
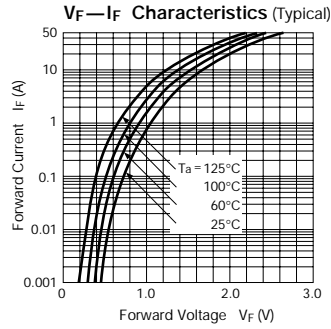
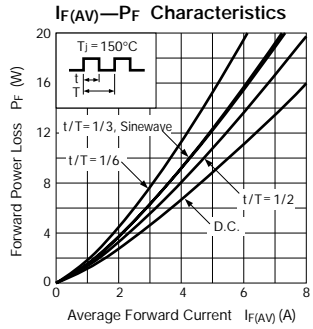
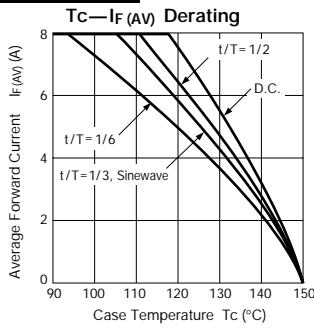

FMQ-G5FMS

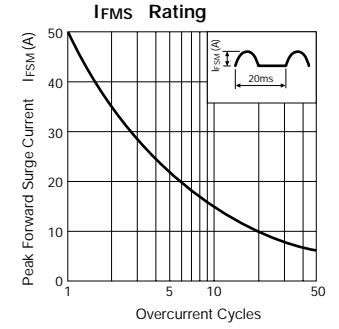
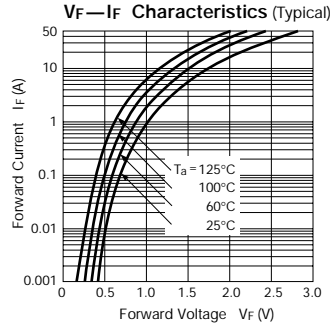
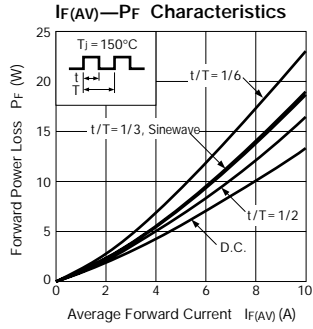
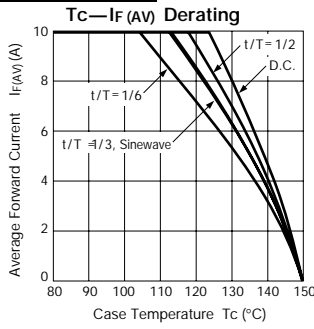

FMQ-G5GS

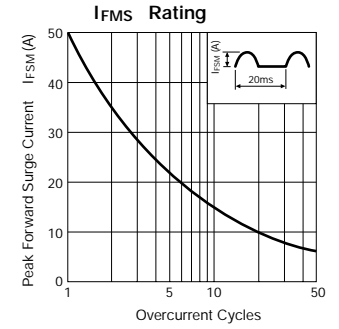
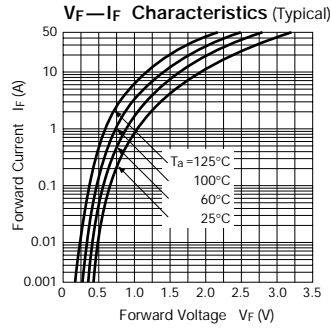
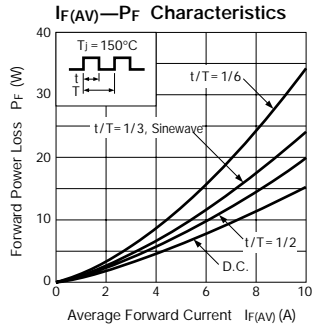
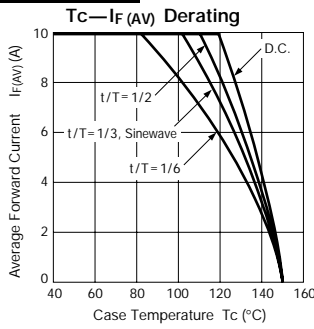

FMR-G5HS

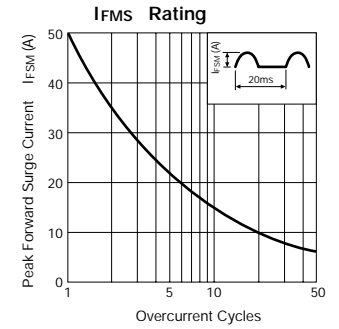
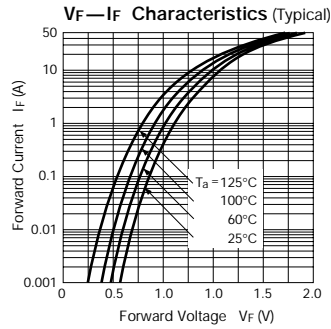
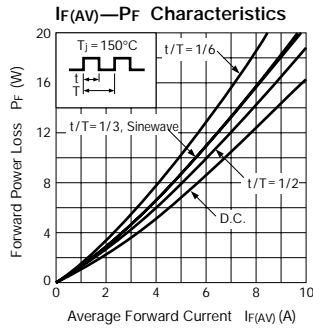
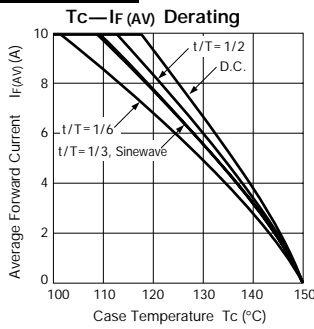

Characteristic Curves Damper Diodes

FMV-3FU

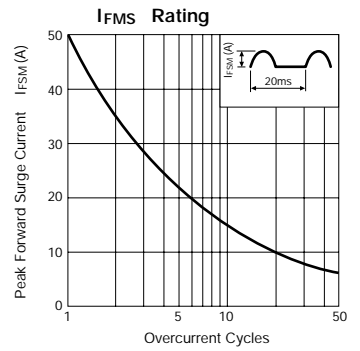
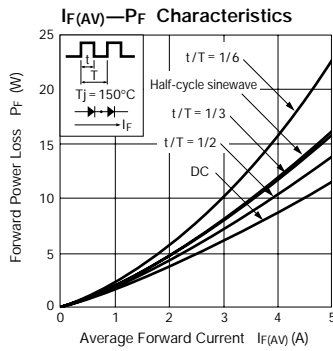
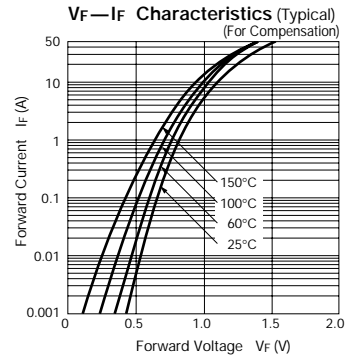
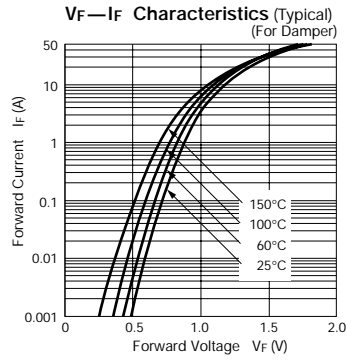
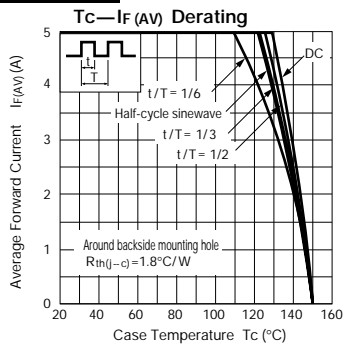

FMV-3GU

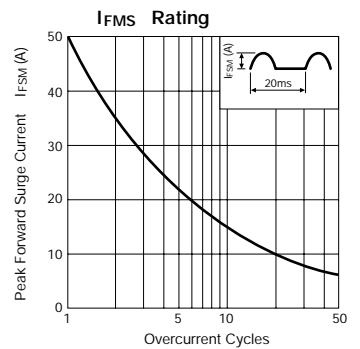
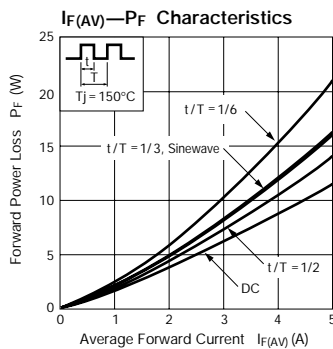
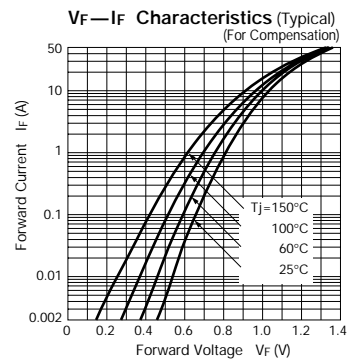
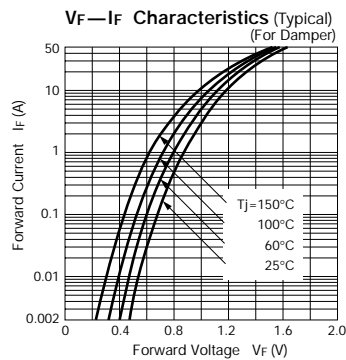
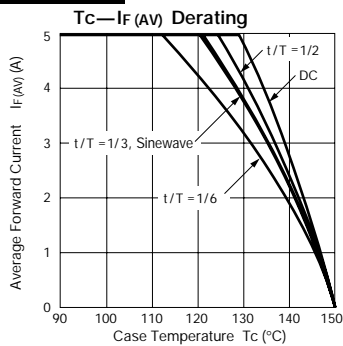

Characteristic Curves Damper Diodes

FMP-3FU

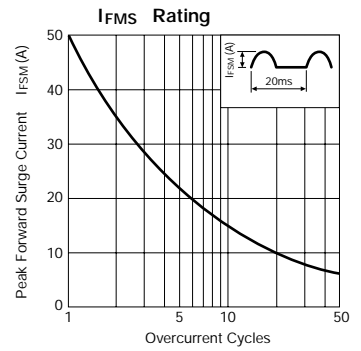
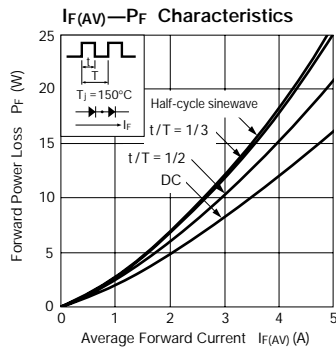
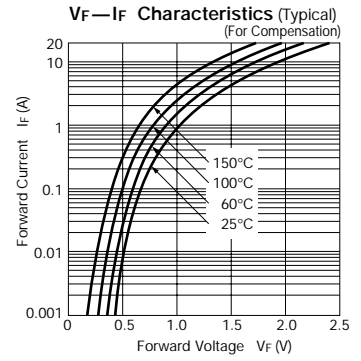
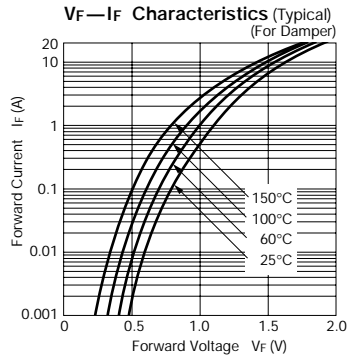
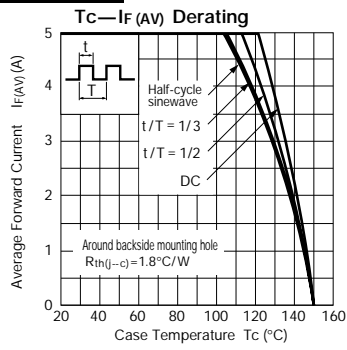

FMO-3GU

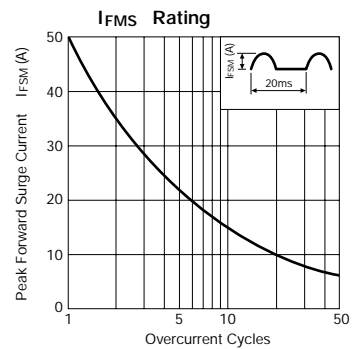
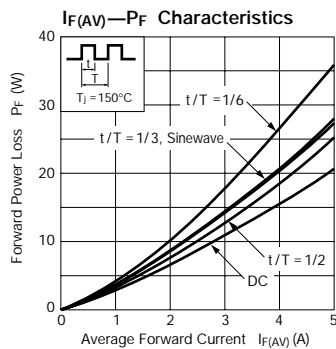
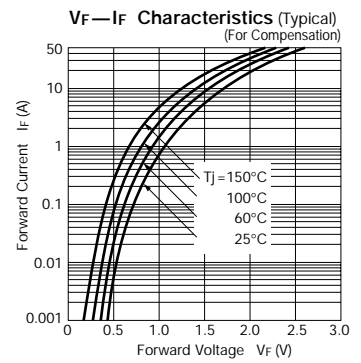
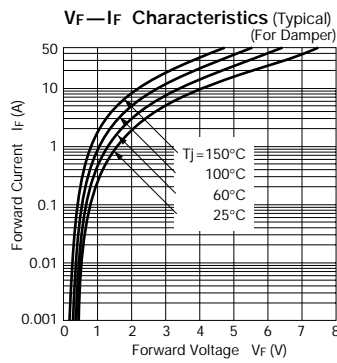
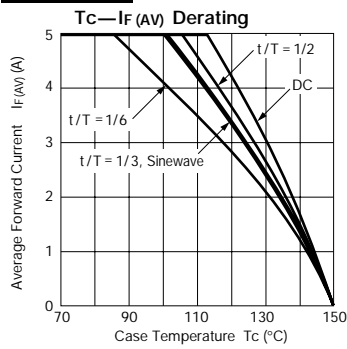

Characteristic Curves Damper Diodes

FMP-2FUR

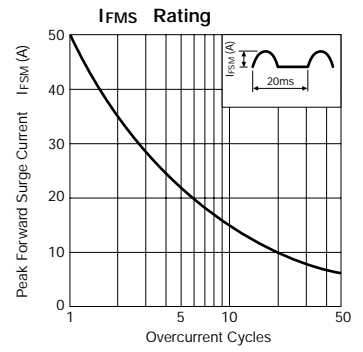
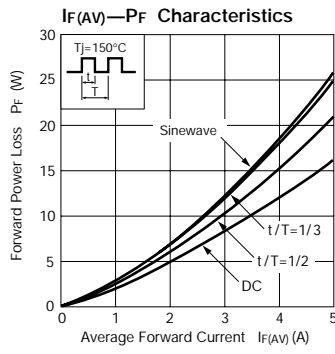
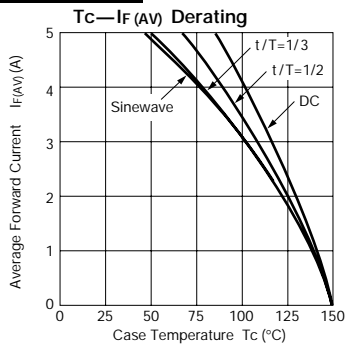

FMQ-2FUR

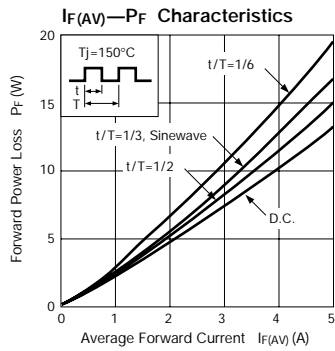
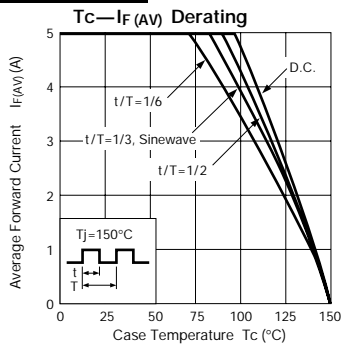

Avalanche Diodes with built-in Thyristor

RZ1030

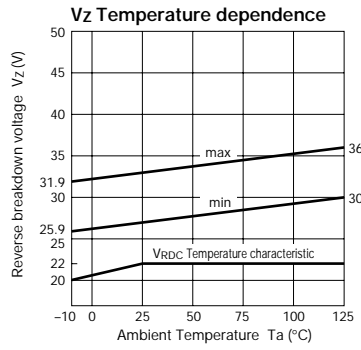
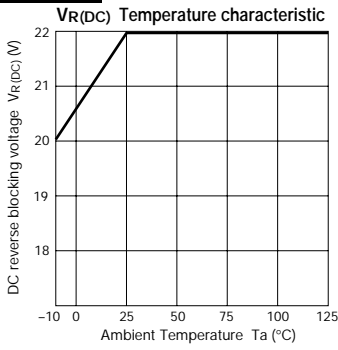

RZ1040

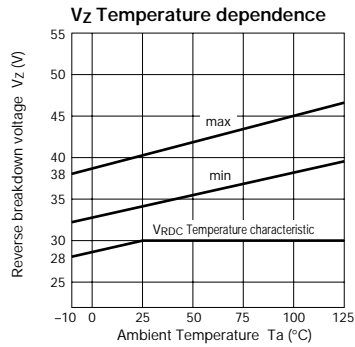
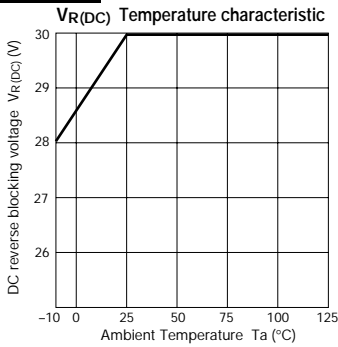

RZ1055

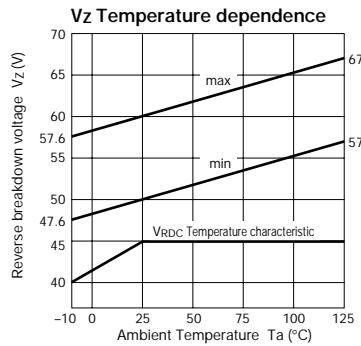
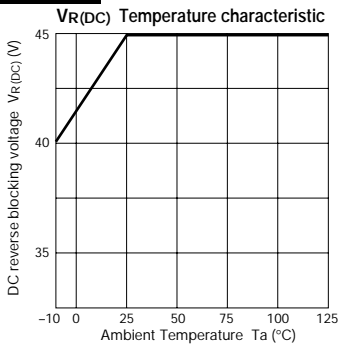

RZ1150

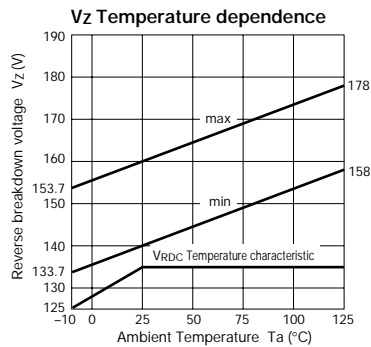
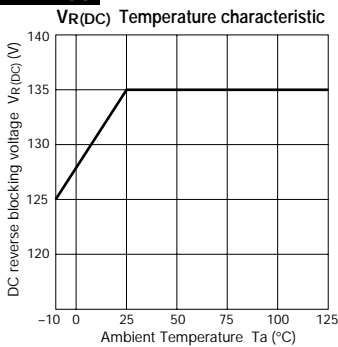

RZ1175

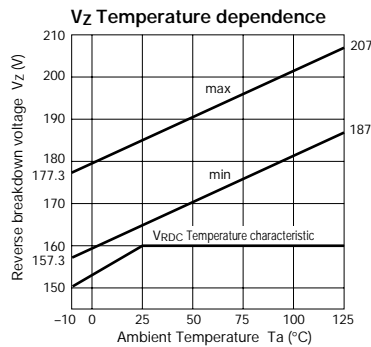
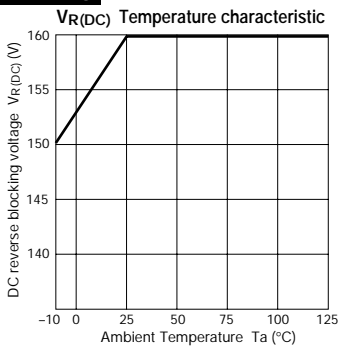

Avalanche Diodes with built-in Thyristor

RZ1200

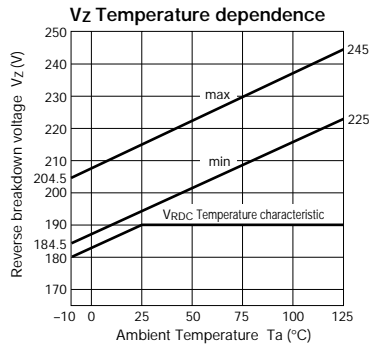
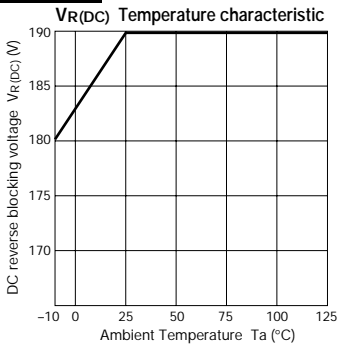

RZ1235

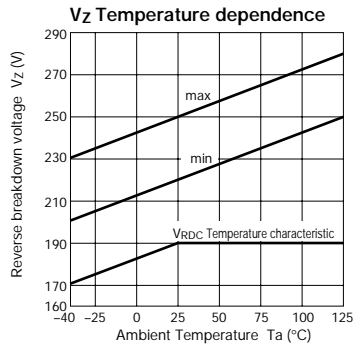
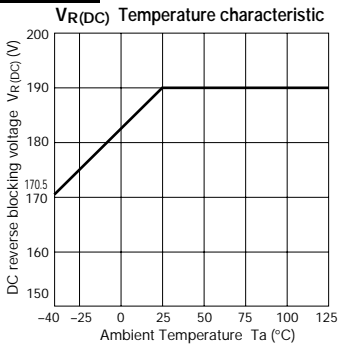

EZ0150

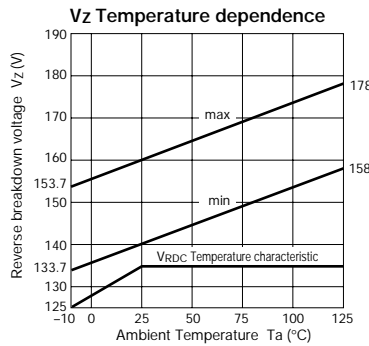
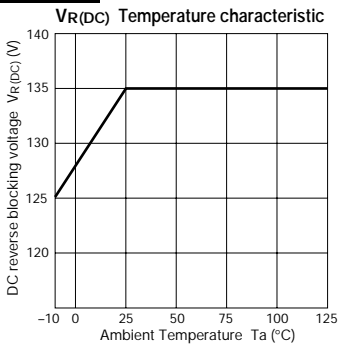

Power Zener Diodes

PZ 628

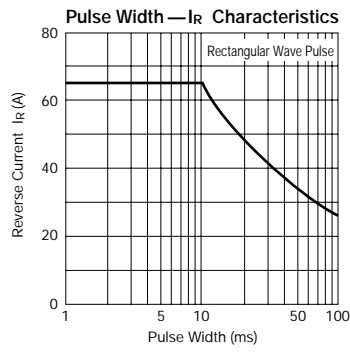
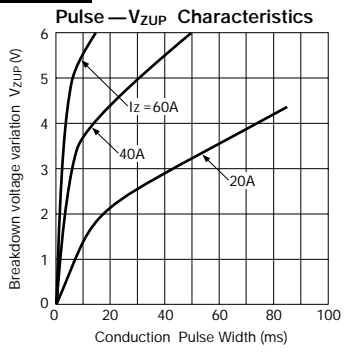

Characteristic Curves Silicon Varistors

SV-2SS, 3SS, 4SS

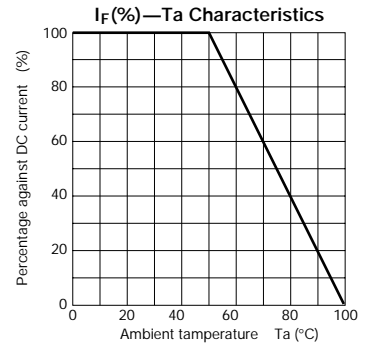
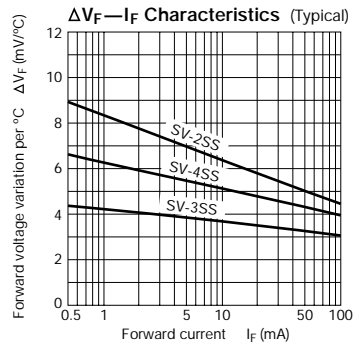
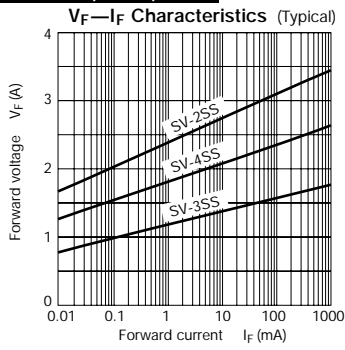

VR-60SS, 61SS

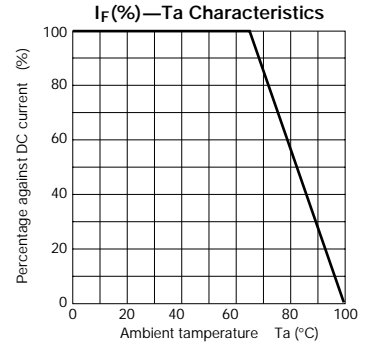
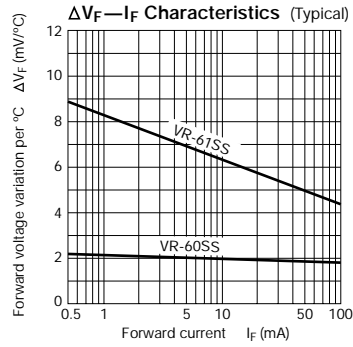
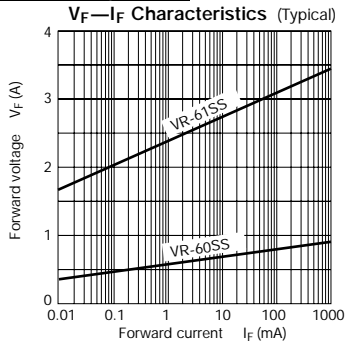

SV 02YS, 03YS, 04YS, 05YS, 06YS

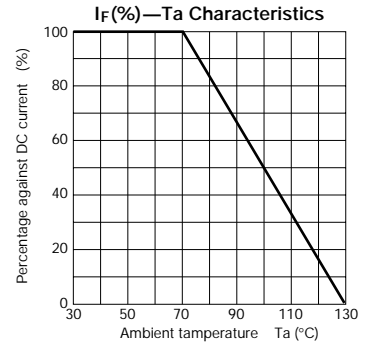
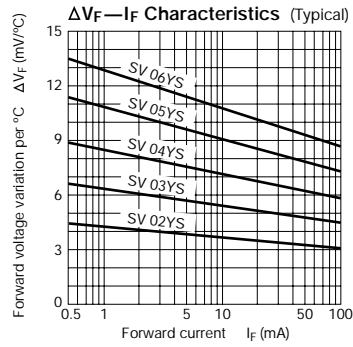
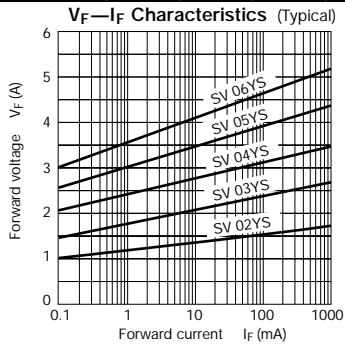

Application Notes

● Ordinary Diodes

① Lead forming

When forming leads, hold the lead wire on the main body's side so as to prevent stress from being applied to the main body.

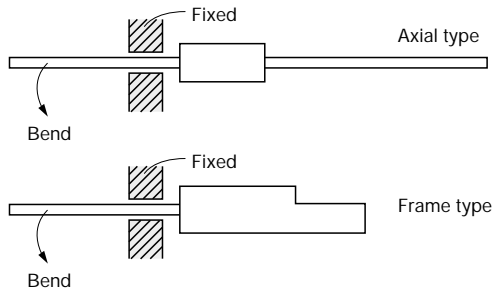

② Mounting

To mount a frame-type diode on a heatsink, use its screw hole. Do not fix its resin body as the silicon chip may get broken.

③ Temperature measurement

For an axial type diode, measure the temperature of the lead wire on the main body side. The thermocouple to be used must be as thin as possible (approximately $\phi 0.125$).

④ Temperature rise

A diode's temperature increases due to losses from forward current, reverse current and reverse recovery time.

In normal use, losses are mainly attributable to forward current and voltage. However, in high frequency circuits such as switching power supplies, losses due to reverse recovery time also occurs. Moreover, in diodes having large reverse currents like Schottky barrier diodes losses due to reverse current cannot be disregarded.

Forward loss tends to decrease at high temperatures. However, reverse loss tends to increase at high temperatures. Therefore, it is necessary to consider the ambient temperature when verifying operation.

⑤ Inrush current

In a capacitor-input type rectifier circuit, inrush current flows when the power supply is switched on. The peak value of this inrush current shall be set less than peak forward surge current I_{FSM} ($I^2 t$ can also be obtained but set the minimum pulse width to 1 msec). The value of I_{FSM} is guaranteed for a single shot only. If the inrush current is repeated within a short period of time, the derating has to be taken into account.

⑥ Peak value current

Limit of the peak value current must be set to 10 times of the average current (I_o or $I_{F(AV)}$) under normal use. If the peak value increases, the diode's forward loss also increases. In this case, check the temperature rise.

- Carefully study the mounting method when the usage environment is prone to creeping discharge.

● Surface Mount Diodes

(SFP□ - 5□ / 6□)

Soldering (flow, reflow)

- Use rosin based flux. Never use acidic fluxes.
- To prevent the build-up of large thermal stress, preheat within 1 to 2 minutes at 150°C and solder within the usable range shown below.

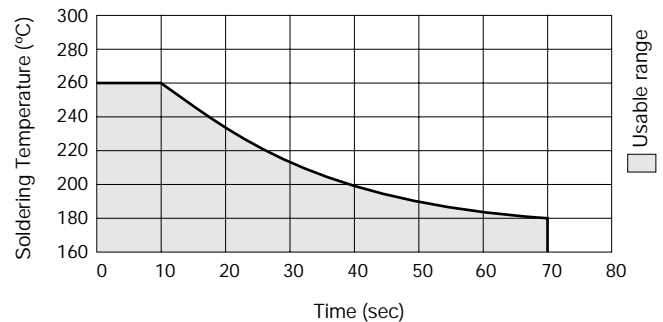

- When using a soldering iron, make use of the following references:

Temperature of soldering Iron Tip:

less than 300°C

(Power of the soldering iron: 30W or less)

The soldering tip must be as thin as possible.

Soldering time: less than 10 seconds

REFERENCE: Copper foil land for mounting SFP series diodes.

(Unit: mm)

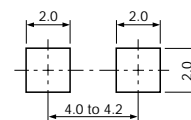

Contact us if there is any unclear point.

Product Index by Part Number

Part Number	Explanation	Page	Part Number	Explanation	Page	Part Number	Explanation	Page
AE 04	Schottky Barrier Diodes (Axial)	36	EM 1B	Rectifier Diodes(Axial)	16	FMB-39M	Schottky Barrier Diodes (Center-tap)	39
AG01	Ultra-Fast-Recovery Rectifier Diodes (Axial)	29	EM 1C	Rectifier Diodes(Axial)	17	FMB-G14	Schottky Barrier Diodes (Frame.1 Chip)	36
AG01A	Ultra-Fast-Recovery Rectifier Diodes (Axial)	30	EM 1Y	Rectifier Diodes(Axial)	12	FMB-G14L	Schottky Barrier Diodes (Frame.1 Chip)	36
AG01Y	Ultra-Fast-Recovery Rectifier Diodes (Axial)	25	EM 1Z	Rectifier Diodes(Axial)	13	FMB-G16L	Schottky Barrier Diodes (Frame.1 Chip)	38
AG01Z	Ultra-Fast-Recovery Rectifier Diodes (Axial)	26	EM 2	Rectifier Diodes(Axial)	14	FMB-G19L	Schottky Barrier Diodes (Frame.1 Chip)	39
AK 03	Schottky Barrier Diodes (Axial)	35	EM 2A	Rectifier Diodes(Axial)	15	FMB-G24H	Schottky Barrier Diodes (Frame.1 Chip)	36
AK 04	Schottky Barrier Diodes (Axial)	36	EM 2B	Rectifier Diodes(Axial)	16	FMC-26U	Ultra-Fast-Recovery Rectifier Diodes (Center-tap)	30
AK 06	Schottky Barrier Diodes (Axial)	38	EM01	Rectifier Diodes(Axial)	14	FMC-26UA	Ultra-Fast-Recovery Rectifier Diodes (Center-tap)	34
AK 09	Schottky Barrier Diodes (Axial)	39	EM01A	Rectifier Diodes(Axial)	15	FMC-28U	Ultra-Fast-Recovery Rectifier Diodes (Center-tap)	32
AL01	Ultra-Fast-Recovery Rectifier Diodes (Axial)	29	EM01Z	Rectifier Diodes(Axial)	13	FMC-28UA	Ultra-Fast-Recovery Rectifier Diodes (Center-tap)	34
AL01Z	Ultra-Fast-Recovery Rectifier Diodes (Axial)	26	EN01Z	Ultra-Fast-Recovery Rectifier Diodes (Axial)	26	FMC-G28S	Ultra-Fast-Recovery Rectifier Diodes (Frame.1 Chip)	32
AM01	Rectifier Diodes (Axial)	14	EP01C	Ultra-Fast-Recovery Rectifier Diodes (Axial)	33	FMC-G28SL	Ultra-Fast-Recovery Rectifier Diodes (Frame.1 Chip)	32
AM01A	Rectifier Diodes (Axial)	15	ES 1	Fast-Recovery Rectifier Diodes (Axial)	20	FMD-G26S	Ultra-Fast-Recovery Rectifier Diodes (Frame.1 Chip)	30
AM01Z	Rectifier Diodes (Axial)	13	ES 1A	Fast-Recovery Rectifier Diodes (Axial)	21	FME-2104	Schottky Barrier Diodes (Center-tap)	36
AP01C	Ultra-Fast-Recovery Rectifier Diodes (Axial)	33	ES 1F	Fast-Recovery Rectifier Diodes (Axial)	24	FME-2106	Schottky Barrier Diodes (Center-tap)	38
AS01	Fast-Recovery Rectifier Diodes (Axial)	20	ES 1Z	Fast-Recovery Rectifier Diodes (Axial)	19	FME-220A	Schottky Barrier Diodes (Center-tap)	39
AS01A	Fast-Recovery Rectifier Diodes (Axial)	21	ES01	Fast-Recovery Rectifier Diodes (Axial)	20	FME-230A	Schottky Barrier Diodes (Center-tap)	39
AS01Z	Fast-Recovery Rectifier Diodes (Axial)	19	ES01A	Fast-Recovery Rectifier Diodes (Axial)	21	FME-24H	Schottky Barrier Diodes (Center-tap)	36
AU01	Fast-Recovery Rectifier Diodes (Axial)	20	ES01F	Fast-Recovery Rectifier Diodes (Axial)	24	FMG-12S,R	Ultra-Fast-Recovery Rectifier Diodes (Center-tap)	26
AU01A	Fast-Recovery Rectifier Diodes (Axial)	21	ES01Z	Fast-Recovery Rectifier Diodes (Axial)	19	FMG-13S,R	Ultra-Fast-Recovery Rectifier Diodes (Center-tap)	28
AU01Z	Fast-Recovery Rectifier Diodes (Axial)	19	EU 1	Fast-Recovery Rectifier Diodes (Axial)	20	FMG-14S,R	Ultra-Fast-Recovery Rectifier Diodes (Center-tap)	29
AU02	Fast-Recovery Rectifier Diodes (Axial)	20	EU 1A	Fast-Recovery Rectifier Diodes (Axial)	21	FMG-22S,R	Ultra-Fast-Recovery Rectifier Diodes (Center-tap)	26
AU02A	Fast-Recovery Rectifier Diodes (Axial)	21	EU 1Z	Fast-Recovery Rectifier Diodes (Axial)	19	FMG-23S,R	Ultra-Fast-Recovery Rectifier Diodes (Center-tap)	28
AU02Z	Fast-Recovery Rectifier Diodes (Axial)	19	EU 2	Fast-Recovery Rectifier Diodes (Axial)	20	FMG-24S,R	Ultra-Fast-Recovery Rectifier Diodes (Center-tap)	29
AW 04	Schottky Barrier Diodes (Axial)	36	EU 2A	Fast-Recovery Rectifier Diodes (Axial)	21	FMG-26S,R	Ultra-Fast-Recovery Rectifier Diodes (Center-tap)	30
EA 03	Schottky Barrier Diodes (Axial)	35	EU 2YX	Fast-Recovery Rectifier Diodes (Axial)	18	FMG-32S,R	Ultra-Fast-Recovery Rectifier Diodes (Center-tap)	26
EE 04	Schottky Barrier Diodes (Axial)	36	EU 2Z	Fast-Recovery Rectifier Diodes (Axial)	19	FMG-33S,R	Ultra-Fast-Recovery Rectifier Diodes (Center-tap)	28
EG 1	Ultra-Fast-Recovery Rectifier Diodes (Axial)	29	EU01	Fast-Recovery Rectifier Diodes (Axial)	20	FMG-34S,R	Ultra-Fast-Recovery Rectifier Diodes (Center-tap)	29
EG 1A	Ultra-Fast-Recovery Rectifier Diodes (Axial)	30	EU01A	Fast-Recovery Rectifier Diodes (Axial)	21	FMG-36S,R	Ultra-Fast-Recovery Rectifier Diodes (Center-tap)	30
EG 1Y	Ultra-Fast-Recovery Rectifier Diodes (Axial)	25	EU01Z	Fast-Recovery Rectifier Diodes (Axial)	19	FMG-G26S	Ultra-Fast-Recovery Rectifier Diodes (Frame.1 Chip)	30
EG 1Z	Ultra-Fast-Recovery Rectifier Diodes (Axial)	26	EU02	Fast-Recovery Rectifier Diodes (Axial)	20	FMG-G2CS	Ultra-Fast-Recovery Rectifier Diodes (Frame.1 Chip)	33
EG01	Ultra-Fast-Recovery Rectifier Diodes (Axial)	29	EU02A	Fast-Recovery Rectifier Diodes (Axial)	21	FMG-G36S	Ultra-Fast-Recovery Rectifier Diodes (Frame.1 Chip)	30
EG01A	Ultra-Fast-Recovery Rectifier Diodes (Axial)	30	EU02Z	Fast-Recovery Rectifier Diodes (Axial)	19	FMG-G3CS	Ultra-Fast-Recovery Rectifier Diodes (Frame.1 Chip)	33
EG01C	Ultra-Fast-Recovery Rectifier Diodes (Axial)	33	EZ0150	Avalanche Diodes with built-in Thyristor	44	FMJ-2203	Schottky Barrier Diodes (Center-tap)	35
EG01Y	Ultra-Fast-Recovery Rectifier Diodes (Axial)	25	FMB-2204	Schottky Barrier Diodes (Center-tap)	36	FMJ-2303	Schottky Barrier Diodes (Center-tap)	35
EG01Z	Ultra-Fast-Recovery Rectifier Diodes (Axial)	26	FMB-2206	Schottky Barrier Diodes (Center-tap)	38	FMJ-23L	Schottky Barrier Diodes (Center-tap)	35
EH 1	Fast-Recovery Rectifier Diodes (Axial)	20	FMB-2304	Schottky Barrier Diodes (Center-tap)	36	FML-12S	Ultra-Fast-Recovery Rectifier Diodes (Center-tap)	26
EH 1A	Fast-Recovery Rectifier Diodes (Axial)	21	FMB-2306	Schottky Barrier Diodes (Center-tap)	38	FML-13S	Ultra-Fast-Recovery Rectifier Diodes (Center-tap)	28
EH 1Z	Fast-Recovery Rectifier Diodes (Axial)	19	FMB-24	Schottky Barrier Diodes (Center-tap)	36	FML-14S	Ultra-Fast-Recovery Rectifier Diodes (Center-tap)	29
EK 03	Schottky Barrier Diodes (Axial)	35	FMB-24H	Schottky Barrier Diodes (Center-tap)	36	FML-22S	Ultra-Fast-Recovery Rectifier Diodes (Center-tap)	26
EK 04	Schottky Barrier Diodes (Axial)	36	FMB-24L	Schottky Barrier Diodes (Center-tap)	36	FML-23S	Ultra-Fast-Recovery Rectifier Diodes (Center-tap)	28
EK 06	Schottky Barrier Diodes (Axial)	38	FMB-24M	Schottky Barrier Diodes (Center-tap)	36	FML-24S	Ultra-Fast-Recovery Rectifier Diodes (Center-tap)	29
EK 09	Schottky Barrier Diodes (Axial)	39	FMB-26	Schottky Barrier Diodes (Center-tap)	38	FML-32S	Ultra-Fast-Recovery Rectifier Diodes (Center-tap)	26
EK 13	Schottky Barrier Diodes (Axial)	35	FMB-26L	Schottky Barrier Diodes (Center-tap)	38	FML-33S	Ultra-Fast-Recovery Rectifier Diodes (Center-tap)	28
EK 14	Schottky Barrier Diodes (Axial)	36	FMB-29	Schottky Barrier Diodes (Center-tap)	39	FML-34S	Ultra-Fast-Recovery Rectifier Diodes (Center-tap)	29
EK 16	Schottky Barrier Diodes (Axial)	38	FMB-29L	Schottky Barrier Diodes (Center-tap)	39	FML-36S	Ultra-Fast-Recovery Rectifier Diodes (Center-tap)	30
EK 19	Schottky Barrier Diodes (Axial)	39	FMB-34	Schottky Barrier Diodes (Center-tap)	36	FML-G12S	Ultra-Fast-Recovery Rectifier Diodes (Frame.1 Chip)	26
EL 1	Ultra-Fast-Recovery Rectifier Diodes (Axial)	29	FMB-34M	Schottky Barrier Diodes (Center-tap)	36	FML-G13S	Ultra-Fast-Recovery Rectifier Diodes (Frame.1 Chip)	28
EL 1Z	Ultra-Fast-Recovery Rectifier Diodes (Axial)	26	FMB-34S	Schottky Barrier Diodes (Center-tap)	36	FML-G14S	Ultra-Fast-Recovery Rectifier Diodes (Frame.1 Chip)	29
EL02Z	Ultra-Fast-Recovery Rectifier Diodes (Axial)	26	FMB-36	Schottky Barrier Diodes (Center-tap)	38	FML-G16S	Ultra-Fast-Recovery Rectifier Diodes (Frame.1 Chip)	30
EM 1	Rectifier Diodes (Axial)	14	FMB-36M	Schottky Barrier Diodes (Center-tap)	38	FML-G22S	Ultra-Fast-Recovery Rectifier Diodes (Frame.1 Chip)	26
EM 1A	Rectifier Diodes(Axial)	15	FMB-39	Schottky Barrier Diodes (Center-tap)	39	FMM-22S,R	Rectifier Diodes (Center-tap)	13

Product Index by Part Number

Part Number	Explanation	Page
FMM-24S,R	Rectifier Diodes (Center-tap)	14
FMM-26S,R	Rectifier Diodes (Center-tap)	15
FMM-31S,R	Rectifier Diodes (Center-tap)	12
FMM-32S,R	Rectifier Diodes (Center-tap)	13
FMM-34S,R	Rectifier Diodes (Center-tap)	14
FMM-36S,R	Rectifier Diodes (Center-tap)	15
FMN-G12S	Ultra-Fast-Recovery Rectifier Diodes (Frame.1Chip)	26
FMN-G14S	Ultra-Fast-Recovery Rectifier Diodes (Frame.1Chip)	29
FMN-G16S	Ultra-Fast-Recovery Rectifier Diodes (Frame.1Chip)	30
FMP-2FUR	Damper Diode (Diode modulation)	41
FMP-3FU	Damper Diode (Diode modulation)	41
FMP-G12S	Ultra-Fast-Recovery Rectifier Diodes (Frame.1Chip)	26
FMP-G5HS	Damper Diode (Frame.1Chip)	24,40
FMQ-2FUR	Damper Diode (Diode modulation)	41
FMQ-3GU	Damper Diode (Diode modulation)	41
FMQ-G1FS	Damper Diode (Frame.1Chip)	24,40
FMQ-G2FLS	Damper Diode (Frame.1Chip)	24,40
FMQ-G2FMS	Damper Diode (Frame.1Chip)	24,40
FMQ-G2FS	Damper Diode (Frame.1Chip)	24,40
FMQ-G5FMS	Damper Diode (Frame.1Chip)	24,40
FMQ-G5GS	Damper Diode (Frame.1Chip)	24,40
FMR-G5HS	Damper Diode (Frame.1Chip)	24,40
FMT-2FUR	Damper Diode (Diode modulation)	41
FMU-12S,R	Fast-Recovery Rectifier Diodes (Center-tap)	19
FMU-14S,R	Fast-Recovery Rectifier Diodes (Center-tap)	20
FMU-16S,R	Fast-Recovery Rectifier Diodes (Center-tap)	21
FMU-21S,R	Fast-Recovery Rectifier Diodes (Center-tap)	18
FMU-22S,R	Fast-Recovery Rectifier Diodes (Center-tap)	19
FMU-24S,R	Fast-Recovery Rectifier Diodes (Center-tap)	20
FMU-26S,R	Fast-Recovery Rectifier Diodes (Center-tap)	21
FMU-32S,R	Fast-Recovery Rectifier Diodes (Center-tap)	19
FMU-34S,R	Fast-Recovery Rectifier Diodes (Center-tap)	20
FMU-36S,R	Fast-Recovery Rectifier Diodes (Center-tap)	21
FMU-G2FS	Damper Diode (Frame.1Chip)	24,40
FMU-G2YXS	Fast-Recovery Rectifier Diodes (Frame.1Chip)	18
FMUP-1056	Fast-Recovery Rectifier Diodes (Frame.1Chip)	21
FMUP-1106	Fast-Recovery Rectifier Diodes (Frame.1Chip)	21
FMUP-2056	Fast-Recovery Rectifier Diodes (Center-tap)	21
FMV-3FU	Damper Diode (Diode modulation)	41
FMV-3GU	Damper Diode (Diode modulation)	41
FMV-G2GS	Damper Diode (Frame.1Chip)	40
FMW-2204	Schottky Barrier Diodes (Center-tap)	36
FMW-24H	Schottky Barrier Diodes (Center-tap)	36
FMW-24L	Schottky Barrier Diodes (Center-tap)	36
FMX-12S	Ultra-Fast-Recovery Rectifier Diodes (Center-tap)	26
FMX-2203	Ultra-Fast-Recovery Rectifier Diodes (Center-tap)	28
FMX-22S	Ultra-Fast-Recovery Rectifier Diodes (Center-tap)	26
FMX-22SL	Ultra-Fast-Recovery Rectifier Diodes (Center-tap)	26
FMX-23S	Ultra-Fast-Recovery Rectifier Diodes (Center-tap)	28
FMX-32S	Ultra-Fast-Recovery Rectifier Diodes (Center-tap)	26
FMX-33S	Ultra-Fast-Recovery Rectifier Diodes (Center-tap)	28
FMX-G12S	Ultra-Fast-Recovery Rectifier Diodes (Frame.1Chip)	26

Part Number	Explanation	Page
FMX-G14S	Ultra-Fast-Recovery Rectifier Diodes (Frame.1Chip)	29
FMX-G16S	Ultra-Fast-Recovery Rectifier Diodes (Frame.1Chip)	30
FMX-G22S	Ultra-Fast-Recovery Rectifier Diodes (Frame.1Chip)	26
FMX-G26S	Ultra-Fast-Recovery Rectifier Diodes (Frame.1Chip)	30
HVR-1X-40B	High-Voltage Rectifier Diodes for Microwave Oven	42
MI1A3	Schottky Barrier Diodes (Surface Mount)	35
MI2A3	Schottky Barrier Diodes (Surface Mount)	35
MP2-202S	Ultra-Fast-Recovery Rectifier Diodes (Surface Mount)	26
MP3-306	Ultra-Fast-Recovery Rectifier Diodes (Surface Mount)	30
MPE-24H	Schottky Barrier Diodes (Surface Mount)	36
MPE-29G	Schottky Barrier Diodes (Surface Mount)	39
MPL-102S	Ultra-Fast-Recovery Rectifier Diodes (Surface Mount)	26
MPX-2103	Ultra-Fast-Recovery Rectifier Diodes (Surface Mount)	28
PZ 628	Power Zener Diodes (Axial)	45
RA 13	Schottky Barrier Diodes (Axial)	35
RBV-1306	Rectifier Diodes (Bridge)	15
RBV-1506	Rectifier Diodes (Bridge)	15
PBV-1506J	Rectifier Diodes (Bridge)	15
RBV-1506S	Rectifier Diodes (Bridge)	15
RBV-150C	Rectifier Diodes (Bridge)	17
RBV-2506	Rectifier Diodes (Bridge)	15
RBV-401	Rectifier Diodes (Bridge)	12
RBV-402	Rectifier Diodes (Bridge)	13
RBV-402L	Ultra-Fast-Recovery Rectifier Diodes (Bridge)	26
RBV-404	Rectifier Diodes (Bridge)	14
RBV-406	Rectifier Diodes (Bridge)	15
RBV-406B	Schottky Barrier Diodes (Bridge)	38
RBV-406H	Rectifier Diodes (Bridge)	15
RBV-406M	Rectifier Diodes (Bridge)	15
RBV-408	Rectifier Diodes (Bridge)	16
RBV-4086H	Rectifier Diodes (Bridge)	15
RBV-40C	Rectifier Diodes (Bridge)	17
RBV-4102	Rectifier Diodes (Bridge)	13
RBV-4106M	Rectifier Diodes (Bridge)	15
RBV-601	Rectifier Diodes (Bridge)	12
RBV-602	Rectifier Diodes (Bridge)	13
RBV-602L	Ultra-Fast-Recovery Rectifier Diodes (Bridge)	26
RBV-604	Rectifier Diodes (Bridge)	14
RBV-606	Rectifier Diodes (Bridge)	15
RBV-606H	Rectifier Diodes (Bridge)	15
RBV-608	Rectifier Diodes (Bridge)	16
RC 2	Fast-Recovery Rectifier Diodes (Axial)	24
RC 3B2	Damper Diodes (For Compensation)	40
RD 2A	Ultra-Fast-Recovery Rectifier Diodes (Axial)	30
RF 1	Fast-Recovery Rectifier Diodes (Axial)	20
RF 1A	Fast-Recovery Rectifier Diodes (Axial)	21
RF 1B	Fast-Recovery Rectifier Diodes (Axial)	22
RF 1Z	Fast-Recovery Rectifier Diodes (Axial)	19
RG 10	Ultra-Fast-Recovery Rectifier Diodes (Axial)	29
RG 10A	Ultra-Fast-Recovery Rectifier Diodes (Axial)	30
RG 10Y	Ultra-Fast-Recovery Rectifier Diodes (Axial)	25
RG 10Z	Ultra-Fast-Recovery Rectifier Diodes (Axial)	26

Part Number	Explanation	Page
RG 1C	Ultra-Fast-Recovery Rectifier Diodes (Axial)	33
RG 2	Ultra-Fast-Recovery Rectifier Diodes (Axial)	29
RG 2A	Ultra-Fast-Recovery Rectifier Diodes (Axial)	30
RG 2A2	Damper Diodes (For Compensation)	40
RG 2Y	Ultra-Fast-Recovery Rectifier Diodes (Axial)	25
RG 2Z	Ultra-Fast-Recovery Rectifier Diodes (Axial)	26
RG 4	Ultra-Fast-Recovery Rectifier Diodes (Axial)	29
RG 4A	Ultra-Fast-Recovery Rectifier Diodes (Axial)	30
RG 4C	Ultra-Fast-Recovery Rectifier Diodes (Axial)	33
RG 4Y	Ultra-Fast-Recovery Rectifier Diodes (Axial)	25
RG 4Z	Ultra-Fast-Recovery Rectifier Diodes (Axial)	26
RH 1	Fast-Recovery Rectifier Diodes (Axial)	20
RH 10F	Damper Diodes (Axial)	24,40
RH 1A	Fast-Recovery Rectifier Diodes (Axial)	21
RH 1B	Fast-Recovery Rectifier Diodes (Axial)	22
RH 1C	Fast-Recovery Rectifier Diodes (Axial)	23
RH 1Z	Fast-Recovery Rectifier Diodes (Axial)	19
RH 2D	Damper Diodes (Axial)	24,40
RH 2F	Damper Diodes (Axial)	24,40
RH 3F	Damper Diodes (Axial)	24,40
RH 3G	Damper Diodes (Axial)	24,40
RH 4F	Damper Diodes (Axial)	24,40
RJ 43	Schottky Barrier Diodes (Axial)	35
RK 13	Schottky Barrier Diodes (Axial)	35
RK 14	Schottky Barrier Diodes (Axial)	36
RK 16	Schottky Barrier Diodes (Axial)	38
RK 19	Schottky Barrier Diodes (Axial)	39
RK 33	Schottky Barrier Diodes (Axial)	35
RK 34	Schottky Barrier Diodes (Axial)	36
RK 36	Schottky Barrier Diodes (Axial)	38
RK 39	Schottky Barrier Diodes (Axial)	39
RK 43	Schottky Barrier Diodes (Axial)	35
RK 44	Schottky Barrier Diodes (Axial)	36
RK 46	Schottky Barrier Diodes (Axial)	38
RK 49	Schottky Barrier Diodes (Axial)	39
RL 10Z	Ultra-Fast-Recovery Rectifier Diodes (Axial)	26
RL 2	Ultra-Fast-Recovery Rectifier Diodes (Axial)	29
RL 2Z	Ultra-Fast-Recovery Rectifier Diodes (Axial)	26
RL 3	Ultra-Fast-Recovery Rectifier Diodes (Axial)	29
RL 3A	Ultra-Fast-Recovery Rectifier Diodes (Axial)	30
RL 3Z	Ultra-Fast-Recovery Rectifier Diodes (Axial)	26
RL 31	Ultra-Fast-Recovery Rectifier Diodes (Axial)	29
RL 4A	Ultra-Fast-Recovery Rectifier Diodes (Axial)	30
RL 4Z	Ultra-Fast-Recovery Rectifier Diodes (Axial)	26
RM 1	Rectifier Diodes (Axial)	14
RM 10	Rectifier Diodes (Axial)	14
RM 10A	Rectifier Diodes (Axial)	15
RM 10B	Rectifier Diodes (Axial)	16
RM 10Z	Rectifier Diodes (Axial)	13
RM 11A	Rectifier Diodes (Axial)	15
RM 11B	Rectifier Diodes (Axial)	16
RM 11C	Rectifier Diodes (Axial)	17

Product Index by Part Number

Part Number	Explanation	Page	Part Number	Explanation	Page	Part Number	Explanation	Page
RM 1A	Rectifier Diodes (Axial)	15	RU 30Z	Fast-Recovery Rectifier Diodes (Axial)	19	SFPL-64	Ultra-Fast-Recovery Rectifier Diodes (Surface Mount)	29
RM 1B	Rectifier Diodes (Axial)	16	RU 31	Fast-Recovery Rectifier Diodes (Axial)	20	SFPM-52	Rectifier Diodes (Surface Mount)	13
RM 1C	Rectifier Diodes (Axial)	17	RU 31A	Fast-Recovery Rectifier Diodes (Axial)	21	SFPM-54	Rectifier Diodes (Surface Mount)	14
RM 1Z	Rectifier Diodes (Axial)	13	RU 3A	Fast-Recovery Rectifier Diodes (Axial)	21	SFPM-62	Rectifier Diodes (Surface Mount)	13
RM 2	Rectifier Diodes (Axial)	14	RU 3AM	Fast-Recovery Rectifier Diodes (Axial)	21	SFPM-64	Rectifier Diodes (Surface Mount)	14
RM 2A	Rectifier Diodes (Axial)	15	RU 3B	Fast-Recovery Rectifier Diodes (Axial)	22	SFPM-74	Rectifier Diodes (Surface Mount)	14
RM 2B	Rectifier Diodes (Axial)	16	RU 3C	Fast-Recovery Rectifier Diodes (Axial)	23	SFPW-56	Ultra-Fast-Recovery Rectifier Diodes (Surface Mount)	38
RM 2C	Rectifier Diodes (Axial)	17	RU 3M	Fast-Recovery Rectifier Diodes (Axial)	20	SFPX-62	Ultra-Fast-Recovery Rectifier Diodes (Surface Mount)	26
RM 2Z	Rectifier Diodes (Axial)	13	RU 3YX	Fast-Recovery Rectifier Diodes (Axial)	18	SFPX-63	Ultra-Fast-Recovery Rectifier Diodes (Surface Mount)	28
RM 3	Rectifier Diodes (Axial)	14	RU 4	Fast-Recovery Rectifier Diodes (Axial)	20	SFPZ-68	Power Zener Doides (Surface Mount)	45
RM 3A	Rectifier Diodes (Axial)	15	RU 4A	Fast-Recovery Rectifier Diodes (Axial)	21	SHV-02	High-Voltage Rectifier Diodes	42
RM 3B	Rectifier Diodes (Axial)	16	RU 4AM	Fast-Recovery Rectifier Diodes (Axial)	21	SHV-03	High-Voltage Rectifier Diodes	42
RM 3C	Rectifier Diodes (Axial)	17	RU 4B	Fast-Recovery Rectifier Diodes (Axial)	22	SHV-03S	High-Voltage Rectifier Diodes	42
RM 4	Rectifier Diodes (Axial)	14	RU 4C	Fast-Recovery Rectifier Diodes (Axial)	23	SHV-05J	High-Voltage Rectifier Diodes for Ignition Coil	42
RM 4A	Rectifier Diodes (Axial)	15	RU 4D	Damper Diodes (Axial)	24,40	SHV-06EN	High-Voltage Rectifier Diodes	42
RM 4AM	Rectifier Diodes (Axial)	15	RU 4DS	Damper Diodes (Axial)	24,40	SHV-06JN	High-Voltage Rectifier Diodes for Ignition Coil	42
RM 4B	Rectifier Diodes (Axial)	16	RU 4M	Fast-Recovery Rectifier Diodes (Axial)	20	SHV-08DN	High-Voltage Rectifier Diodes	42
RM 4C	Rectifier Diodes (Axial)	17	RU 4Y	Fast-Recovery Rectifier Diodes (Axial)	18	SHV-08EN	High-Voltage Rectifier Diodes	42
RM 4Y	Rectifier Diodes (Axial)	12	RU 4YX	Fast-Recovery Rectifier Diodes (Axial)	18	SHV-08J	High-Voltage Rectifier Diodes for Ignition Coil	42
RM 4Z	Rectifier Diodes (Axial)	13	RU 4Z	Fast-Recovery Rectifier Diodes (Axial)	19	SHV-10	High-Voltage Rectifier Diodes	42
RN 1Z	Ultra-Fast-Recovery Rectifier Diodes (Axial)	26	RX 10Z	Ultra-Fast-Recovery Rectifier Diodes (Axial)	26	SHV-10DN	High-Voltage Rectifier Diodes	42
RN 2Z	Ultra-Fast-Recovery Rectifier Diodes (Axial)	26	RX 3Z	Ultra-Fast-Recovery Rectifier Diodes (Axial)	26	SHV-10EN	High-Voltage Rectifier Diodes	42
RN 3Z	Ultra-Fast-Recovery Rectifier Diodes (Axial)	26	RZ1030	Avalanche Diodes with built-in Thyristor (Axial)	44	SHV-12	High-Voltage Rectifier Diodes	42
RN 4Z	Ultra-Fast-Recovery Rectifier Diodes (Axial)	26	RZ1040	Avalanche Diodes with built-in Thyristor (Axial)	44	SHV-12DN	High-Voltage Rectifier Diodes	42
RO 2	Rectifier Diodes (Axial)	14	RZ1055	Avalanche Diodes with built-in Thyristor (Axial)	44	SHV-12EN	High-Voltage Rectifier Diodes	42
RO 2A	Rectifier Diodes (Axial)	15	RZ1065	Avalanche Diodes with built-in Thyristor (Axial)	44	SHV-14	High-Voltage Rectifier Diodes	42
RO 2B	Rectifier Diodes (Axial)	16	RZ1100	Avalanche Diodes with built-in Thyristor (Axial)	44	SHV-16	High-Voltage Rectifier Diodes	42
RO 2C	Rectifier Diodes (Axial)	17	RZ1125	Avalanche Diodes with built-in Thyristor (Axial)	44	SHV-20	High-Voltage Rectifier Diodes	42
RO 2Z	Rectifier Diodes (Axial)	13	RZ1150	Avalanche Diodes with built-in Thyristor (Axial)	44	SHV-24	High-Voltage Rectifier Diodes	42
RP 1H	Ultra-Fast-Recovery Rectifier Diodes (Axial)	34	RZ1155	Avalanche Diodes with built-in Thyristor (Axial)	44	SHV-30J	High-Voltage Rectifier Diodes for Ignition Coil	42
RP 3F	Damper Diodes (Axial)	24,40	RZ1175	Avalanche Diodes with built-in Thyristor (Axial)	44	SPB-64S	Schottky Barrier Diodes (Surface Mount)	36
RS 1A	Fast-Recovery Rectifier Diodes (Axial)	21	RZ1200	Avalanche Diodes with built-in Thyristor (Axial)	44	SPB-66S	Schottky Barrier Diodes (Surface Mount)	38
RS 1B	Fast-Recovery Rectifier Diodes (Axial)	22	RZ1235	Avalanche Diodes with built-in Thyristor (Axial)	44	SPB-G34S	Schottky Barrier Diodes (Surface Mount)	36
RS 3FS	Damper Diodes (Axial)	24,40	RZ1250	Avalanche Diodes with built-in Thyristor (Axial)	44	SPB-G54S	Schottky Barrier Diodes (Surface Mount)	36
RS 4FS	Damper Diodes (Axial)	24,40	SFPA-53	Schottky Barrier Diodes (Surface Mount)	35	SPB-G56S	Schottky Barrier Diodes (Surface Mount)	38
RU 1	Fast-Recovery Rectifier Diodes (Axial)	20	SFPA-63	Schottky Barrier Diodes (Surface Mount)	35	SPJ-63S	Schottky Barrier Diodes (Surface Mount)	35
RU 1A	Fast-Recovery Rectifier Diodes (Axial)	21	SFPA-73	Schottky Barrier Diodes (Surface Mount)	35	SPJ-G53S	Schottky Barrier Diodes (Surface Mount)	35
RU 1B	Fast-Recovery Rectifier Diodes (Axial)	22	SFPB-54	Schottky Barrier Diodes (Surface Mount)	36	SPX-62S	Ultra-Fast-Recovery Rectifier Diodes (Surface Mount)	26
RU 1C	Fast-Recovery Rectifier Diodes (Axial)	23	SFPB-56	Schottky Barrier Diodes (Surface Mount)	38	SPX-G32S	Ultra-Fast-Recovery Rectifier Diodes (Surface Mount)	26
RU 1P	Ultra-Fast-Recovery Rectifier Diodes (Axial)	33	SFPB-59	Schottky Barrier Diodes (Surface Mount)	39	SPZ-G36	Power Zener Doides (Surface Mount)	45
RU 2	Fast-Recovery Rectifier Diodes (Axial)	21	SFPB-64	Schottky Barrier Diodes (Surface Mount)	36	SV 02YS	Silicon Varistors (Axial)	47
RU 20A	Fast-Recovery Rectifier Diodes (Axial)	21	SFPB-66	Schottky Barrier Diodes (Surface Mount)	38	SV 03YS	Silicon Varistors (Axial)	47
RU 2AM	Fast-Recovery Rectifier Diodes (Axial)	21	SFPB-69	Schottky Barrier Diodes (Surface Mount)	39	SV 04YS	Silicon Varistors (Axial)	47
RU 2B	Fast-Recovery Rectifier Diodes (Axial)	22	SFPB-74	Schottky Barrier Diodes (Surface Mount)	36	SV 05YS	Silicon Varistors (Axial)	47
RU 2C	Fast-Recovery Rectifier Diodes (Axial)	23	SFPB-76	Schottky Barrier Diodes (Surface Mount)	38	SV 06YS	Silicon Varistors (Axial)	47
RU 2M	Fast-Recovery Rectifier Diodes (Axial)	20	SFPE-63	Schottky Barrier Diodes (Surface Mount)	35	SV-2SS	Silicon Varistors (Axial)	46
RU 2YX	Fast-Recovery Rectifier Diodes (Axial)	18	SFPE-64	Schottky Barrier Diodes (Surface Mount)	36	SV-3SS	Silicon Varistors (Axial)	46
RU 2Z	Fast-Recovery Rectifier Diodes (Axial)	19	SFPJ-53	Schottky Barrier Diodes (Surface Mount)	35	SV-4SS	Silicon Varistors (Axial)	46
RU 3	Fast-Recovery Rectifier Diodes (Axial)	20	SFPJ-63	Schottky Barrier Diodes (Surface Mount)	35	UX-F5B	High-Voltage Rectifier Diodes for Microwave Oven	42
RU 30	Fast-Recovery Rectifier Diodes (Axial)	20	SFPJ-73	Schottky Barrier Diodes (Surface Mount)	35	VR-60SS	Silicon Varistors (Axial)	46
RU 30A	Fast-Recovery Rectifier Diodes (Axial)	21	SFPL-52	Ultra-Fast-Recovery Rectifier Diodes (Surface Mount)	26	VR-61SS	Silicon Varistors (Axial)	46
RU 30Y	Fast-Recovery Rectifier Diodes (Axial)	18	SFPL-62	Ultra-Fast-Recovery Rectifier Diodes (Surface Mount)	26			



Sanken Electric Co., Ltd.
1-11-1 Nishi-Ikebukuro, Toshima-ku, Tokyo
PHONE: 03-3986-6164
FAX: 03-3986-8637

Overseas Sales Offices

●Asia

Sanken Electric Singapore Pte. Ltd.
150 Beach Road, #14-03 The Gateway West,
Singapore 0718
PHONE: 291-4755
FAX: 297-1744

Sanken Electric Hong Kong Co., Ltd.
1018 Ocean Centre, Canton Road,
Kowloon, Hong Kong
PHONE: 2735-5262
FAX: 2735-5494

Sanken Electric Korea Co., Ltd.
SK Life B/D 6F,
168 Kongduk-dong, Mapo-ku, Seoul, 121-705, Korea
PHONE: 82-2-714-3700
FAX: 82-2-3272-2145

●North America

Allegro MicroSystems, Inc.
115 Northeast Cutoff,
Worcester, Massachusetts 01606, U.S.A.
PHONE: (508)853-5000
FAX: (508)853-7861

●Europe

Allegro MicroSystems Europe Limited.
Balfour House, Churchfield Road,
Walton-on-Thames, Surrey KT12 2TD, U.K.
PHONE: 01932-253355
FAX: 01932-246622