

$V_{DRM}$	=	5200 V
$I_{T(AV)M}$	=	2760 A
$I_{T(RMS)}$	=	4340 A
$I_{TSM}$	=	$42 \times 10^3$ A
$V_{T0}$	=	1 V
$r_T$	=	0.225 m $\Omega$

# Phase Control Thyristor

## 5STP 25L5200

Doc. No. 5SYA1008-05 Jan. 11

- Patented free-floating silicon technology
- Low on-state and switching losses
- Designed for traction, energy and industrial applications
- Optimum power handling capability
- Interdigitated amplifying gate

### Blocking

Maximum rated values <sup>1)</sup>

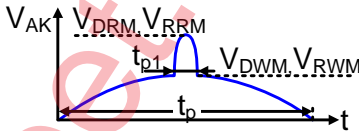
Parameter	Symbol	Conditions	5STP 25L5200	Unit
Max. surge peak forward and reverse blocking voltage	$V_{DSM}$ , $V_{RSM}$	$t_p = 10$ ms, $f = 5$ Hz $T_{vj} = 5 \dots 125^\circ\text{C}$ , Note 1	5200	V
Max repetitive peak forward and reverse blocking voltage	$V_{DRM}$ , $V_{RRM}$	$f = 50$ Hz, $t_p = 10$ ms, $t_{p1} = 250$ $\mu\text{s}$ , $T_{vj} = 5 \dots 125^\circ\text{C}$ , Note 1, Note 2	5200	V
Max crest working forward and reverse voltages	$V_{DWM}$ , $V_{RWM}$		3470	V
Critical rate of rise of commutating voltage	$dv/dt_{crit}$	Exp. to 3470 V, $T_{vj} = 125^\circ\text{C}$	2000	V/ $\mu\text{s}$

Characteristic values

Parameter	Symbol	Conditions	min	typ	max	Unit
Forward leakage current	$I_{DRM}$	$V_{DRM}$ , $T_{vj} = 125^\circ\text{C}$			400	mA
Reverse leakage current	$I_{RRM}$	$V_{RRM}$ , $T_{vj} = 125^\circ\text{C}$			400	mA

Note 1: Voltage de-rating factor of 0.11% per  $^\circ\text{C}$  is applicable for  $T_{vj}$  below  $+5^\circ\text{C}$

Note 2: Recommended minimum ratio of  $V_{DRM} / V_{DWM}$  or  $V_{RRM} / V_{RWM} = 2$ . See App. Note 5SYA 2051.

### Mechanical data

Maximum rated values <sup>1)</sup>

Parameter	Symbol	Conditions	min	typ	max	Unit
Mounting force	$F_M$		63	70	84	kN
Acceleration	a	Device unclamped			50	$\text{m/s}^2$
Acceleration	a	Device clamped			100	$\text{m/s}^2$

Characteristic values

Parameter	Symbol	Conditions	min	typ	max	Unit
Weight	m				1.45	kg
Housing thickness	H	$F_M = 70$ kN, $T_a = 25^\circ\text{C}$	26.2		26.8	mm
Surface creepage distance	$D_S$		36			mm
Air strike distance	$D_a$		15			mm

1) Maximum rated values indicate limits beyond which damage to the device may occur

ABB Switzerland Ltd, Semiconductors reserves the right to change specifications without notice.



## On-state

### Maximum rated values <sup>1)</sup>

Parameter	Symbol	Conditions	min	typ	max	Unit
Average on-state current	$I_{T(AV)M}$	Half sine wave, $T_c = 70\text{ °C}$			2760	A
RMS on-state current	$I_{T(RMS)}$				4340	A
Peak non-repetitive surge current	$I_{TSM}$	$t_p = 10\text{ ms}$ , $T_{vj} = 125\text{ °C}$ , sine wave after surge: $V_D = V_R = 0\text{ V}$			$42 \times 10^3$	A
Limiting load integral	$I^2t$				$8.82 \times 10^6$	A <sup>2</sup> s
Peak non-repetitive surge current	$I_{TSM}$	$t_p = 8.3\text{ ms}$ , $T_{vj} = 125\text{ °C}$ , sine wave after surge: $V_D = V_R = 0\text{ V}$			$45 \times 10^3$	A
Limiting load integral	$I^2t$				$8.4 \times 10^6$	A <sup>2</sup> s

### Characteristic values

Parameter	Symbol	Conditions	min	typ	max	Unit
On-state voltage	$V_T$	$I_T = 3000\text{ A}$ , $T_{vj} = 125\text{ °C}$			1.7	V
Threshold voltage	$V_{(TO)}$	$I_T = 1300\text{ A} - 4000\text{ A}$ , $T_{vj} = 125\text{ °C}$			1	V
Slope resistance	$r_T$				0.225	mΩ
Holding current	$I_H$	$T_{vj} = 25\text{ °C}$			125	mA
		$T_{vj} = 125\text{ °C}$			60	mA
Latching current	$I_L$	$T_{vj} = 25\text{ °C}$			500	mA
		$T_{vj} = 125\text{ °C}$			250	mA

## Switching

### Maximum rated values <sup>1)</sup>

Parameter	Symbol	Conditions	min	typ	max	Unit
Critical rate of rise of on-state current	$di/dt_{crit}$	$T_{vj} = 125\text{ °C}$ , $I_{TRM} = 3000\text{ A}$ , Cont. $f = 50\text{ Hz}$			250	A/μs
Critical rate of rise of on-state current	$di/dt_{crit}$	$V_D \leq 0.67 V_{DRM}$ , $I_{FG} = 2\text{ A}$ , $t_r = 0.5\text{ μs}$ Cont. $f = 1\text{ Hz}$			1000	A/μs
Circuit-commutated turn-off time	$t_q$	$T_{vj} = 125\text{ °C}$ , $I_{TRM} = 2000\text{ A}$ , $V_R = 200\text{ V}$ , $di_T/dt = -1.5\text{ A/μs}$ , $V_D \leq 0.67 \cdot V_{DRM}$ , $dv_D/dt = 20\text{ V/μs}$	700			μs

### Characteristic values

Parameter	Symbol	Conditions	min	typ	max	Unit
Reverse recovery charge	$Q_{rr}$	$T_{vj} = 125\text{ °C}$ , $I_{TRM} = 2000\text{ A}$ , $V_R = 200\text{ V}$ , $di_T/dt = -1.5\text{ A/μs}$	3200		4400	μAs
Reverse recovery current	$I_{RM}$		50		130	A
Gate turn-on delay time	$t_{gd}$	$T_{vj} = 25\text{ °C}$ , $V_D = 0.4 \cdot V_{RM}$ , $I_{FG} = 2\text{ A}$ , $t_r = 0.5\text{ μs}$			3	μs

## Triggering

Maximum rated values <sup>1)</sup>

Parameter	Symbol	Conditions	min	typ	max	Unit
Peak forward gate voltage	$V_{FGM}$				12	V
Peak forward gate current	$I_{FGM}$				10	A
Peak reverse gate voltage	$V_{RGM}$				10	V
Average gate power loss	$P_{G(AV)}$		see Fig. 9			W

Characteristic values

Parameter	Symbol	Conditions	min	typ	max	Unit
Gate-trigger voltage	$V_{GT}$	$T_{vj} = 25\text{ °C}$			2.6	V
Gate-trigger current	$I_{GT}$	$T_{vj} = 25\text{ °C}$			400	mA
Gate non-trigger voltage	$V_{GD}$	$V_D = 0.4 \times V_{DRM}, T_{vjmax} = 125\text{ °C}$	0.3			V
Gate non-trigger current	$I_{GD}$	$V_D = 0.4 \times V_{DRM}, T_{vjmax} = 125\text{ °C}$	10			mA

## Thermal

Maximum rated values <sup>1)</sup>

Parameter	Symbol	Conditions	min	typ	max	Unit
Operating junction temperature range	$T_{vj}$				125	°C
Storage temperature range	$T_{stg}$		-40		140	°C

Characteristic values

Parameter	Symbol	Conditions	min	typ	max	Unit
Thermal resistance junction to case	$R_{th(j-c)}$	Double-side cooled $F_m = 63...84\text{ kN}$			7	K/kW
	$R_{th(j-c)A}$	Anode-side cooled $F_m = 63...84\text{ kN}$			14	K/kW
	$R_{th(j-c)C}$	Cathode-side cooled $F_m = 63...84\text{ kN}$			14	K/kW
Thermal resistance case to heatsink	$R_{th(c-h)}$	Double-side cooled $F_m = 63...84\text{ kN}$			1.5	K/kW
	$R_{th(c-h)}$	Single-side cooled $F_m = 63...84\text{ kN}$			3	K/kW

Analytical function for transient thermal impedance:

$$Z_{th(j-c)}(t) = \sum_{i=1}^n R_i (1 - e^{-t/\tau_i})$$

i	1	2	3	4
$R_i$ (K/kW)	4.700	0.853	1.070	0.490
$\tau_i$ (s)	0.5506	0.0790	0.0107	0.0028

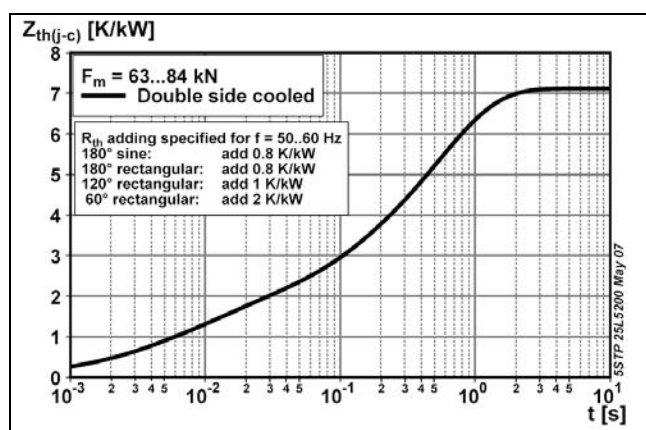
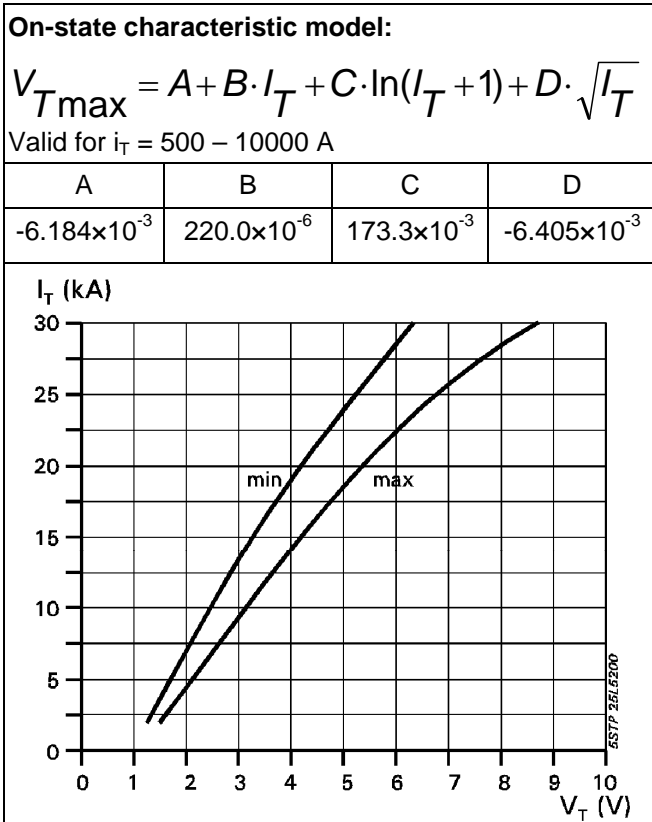
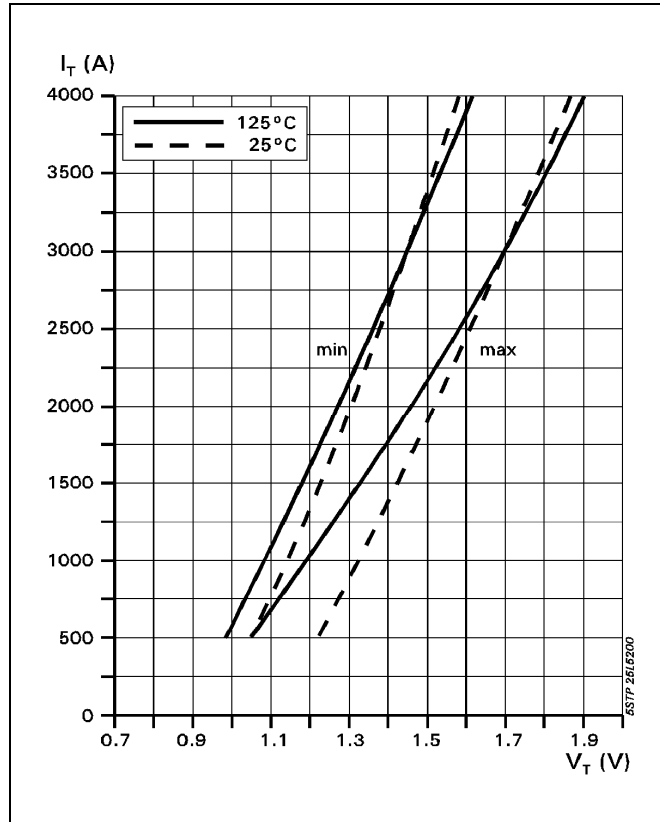

Fig. 1 Transient thermal impedance (junction-to-case) vs. time



**Fig. 2** On-state characteristics,  $T_j=125^\circ\text{C}$ , 10ms half sine



**Fig. 3** On-state voltage characteristics

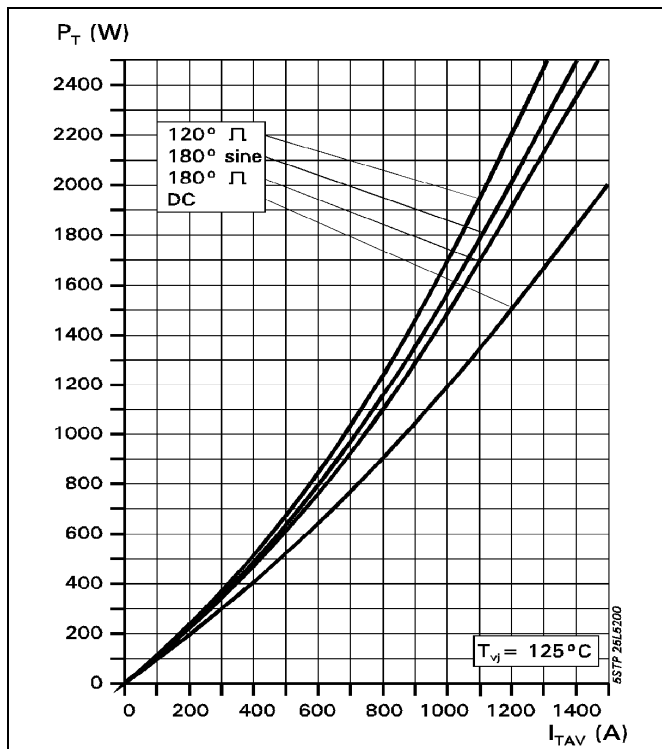

**Fig. 4** On-state power dissipation vs. mean on-state current, turn-on losses excluded

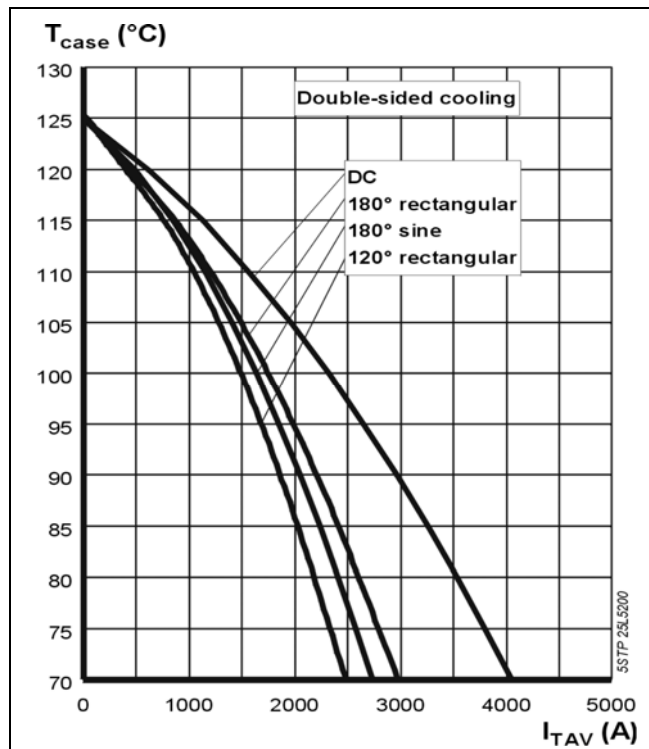

**Fig. 5** Max. permissible case temperature vs. mean on-state current, switching losses ignored

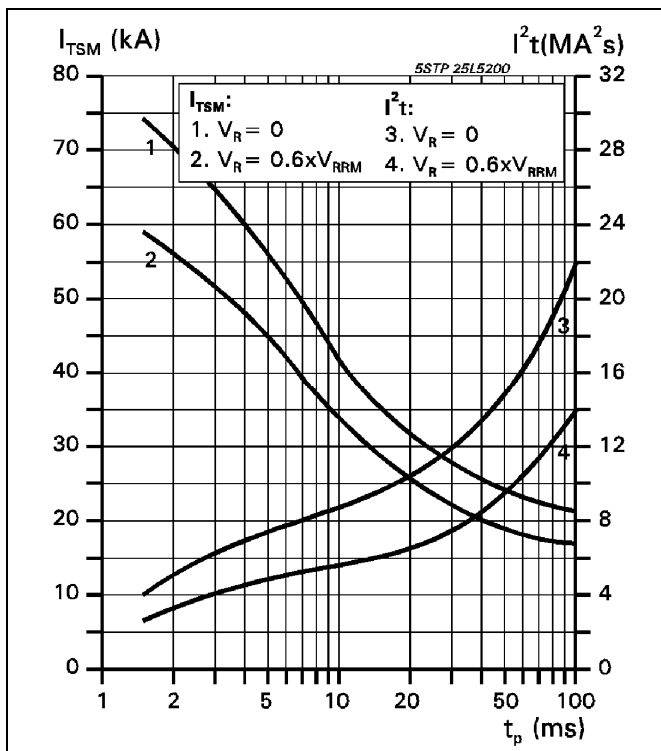

Fig. 6 Surge on-state current vs. pulse length, half-sine wave

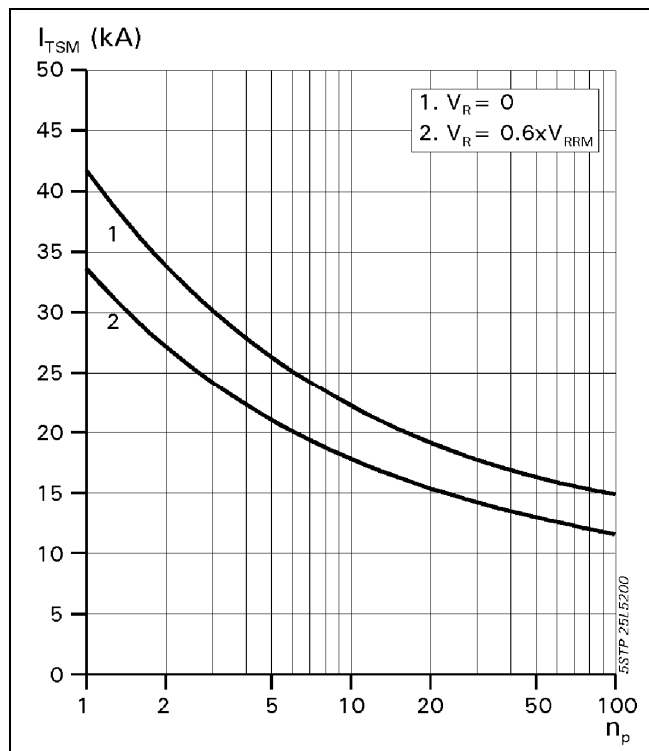

Fig. 7 Surge on-state current vs. number of pulses, half-sine wave, 10 ms, 50Hz

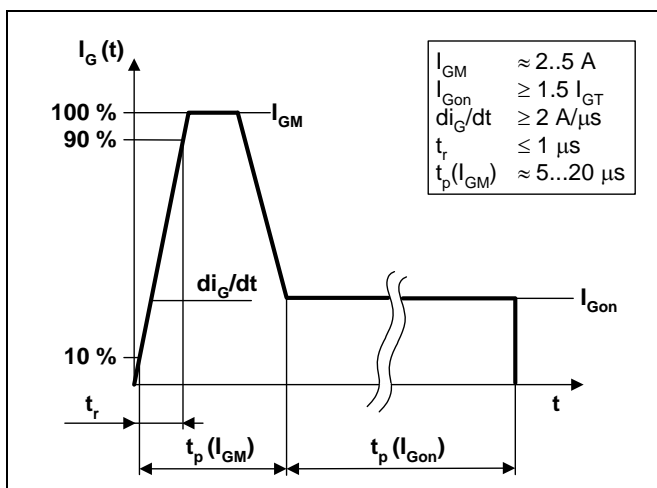

Fig. 8 Recommended gate current waveform

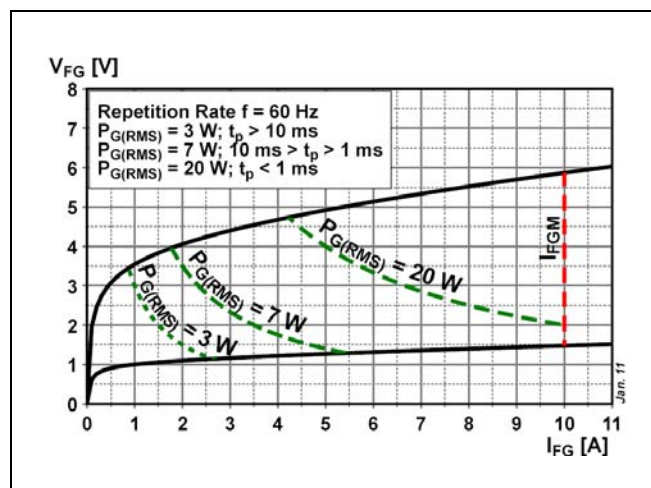

Fig. 9 Max. peak gate power loss

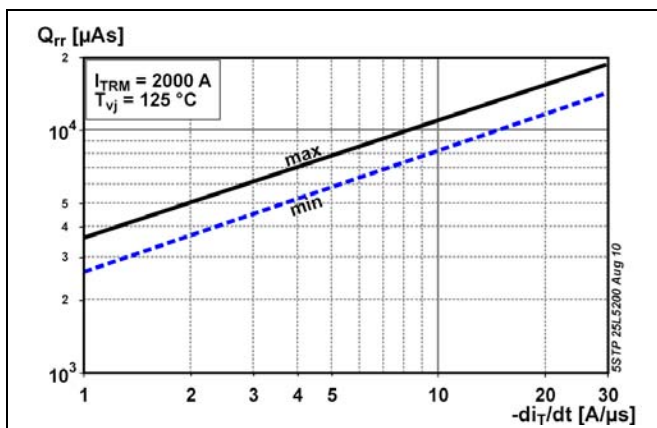

Fig. 10 Reverse recovery charge vs. decay rate of on-state current

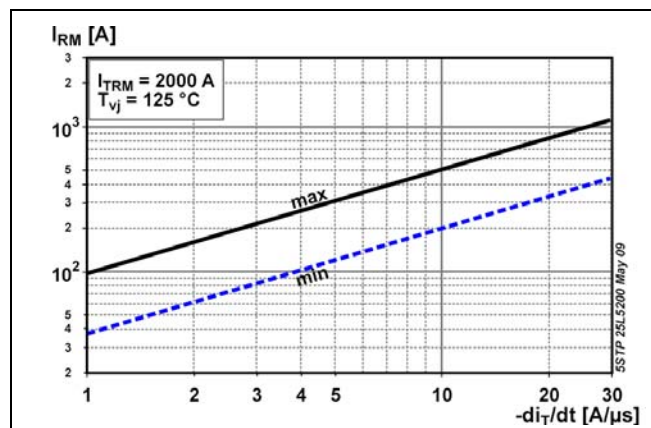

Fig. 11 Peak reverse recovery current vs. decay rate of on-state current

# Turn-on and Turn-off losses

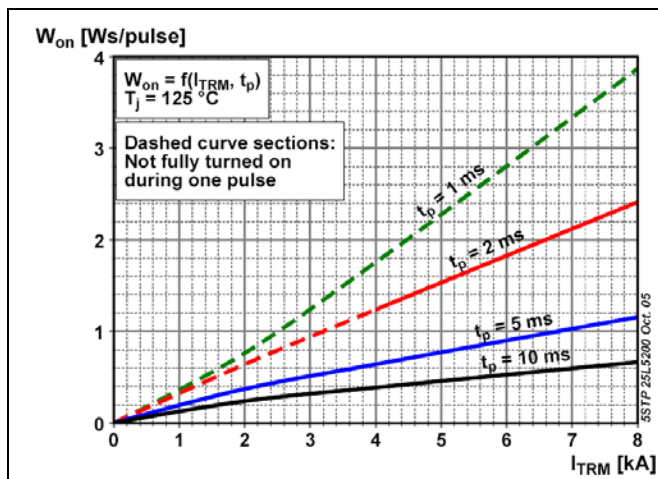

Fig. 12 Turn-on energy, half sinusoidal waves

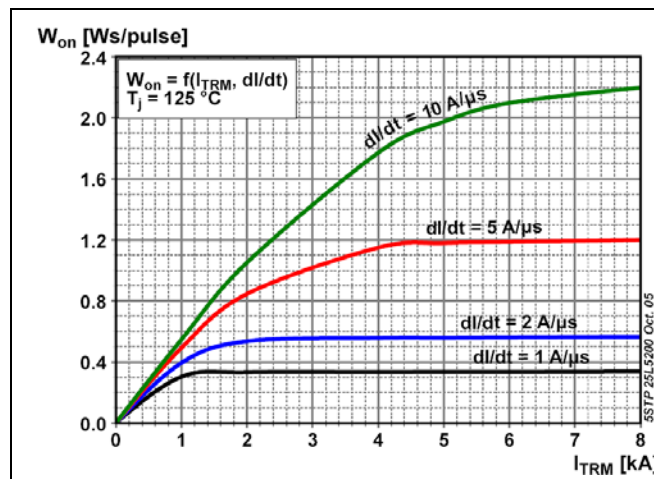

Fig. 13 Turn-on energy, rectangular waves

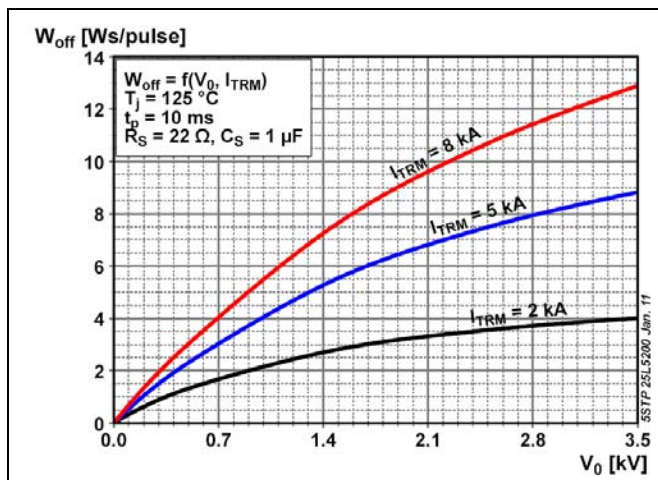

Fig. 14 Turn-off energy, half sinusoidal waves

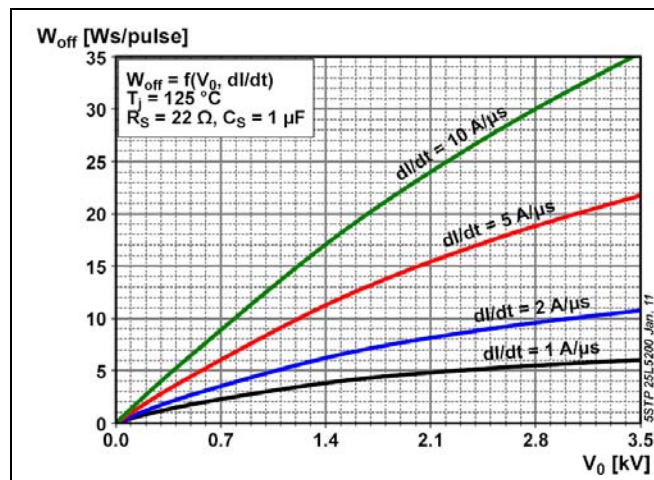

Fig. 15 Turn-off energy, rectangular waves

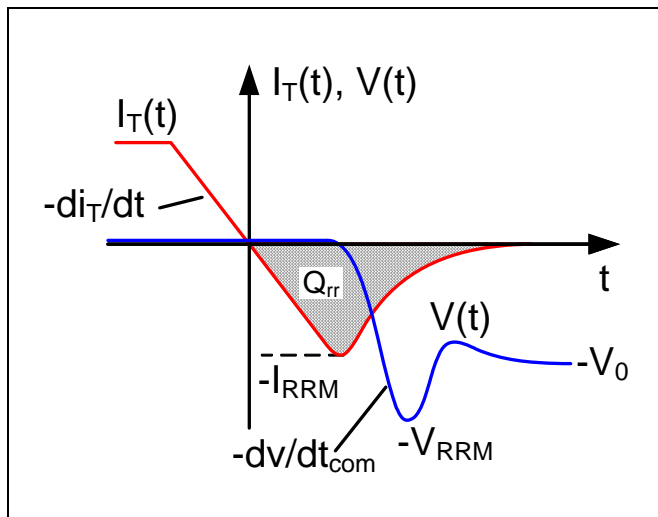

Fig. 16 Current and voltage waveforms at turn-off

**Total power loss for repetitive waveforms:**

$$P_{TOT} = P_T + W_{on} \cdot f + W_{off} \cdot f$$

where

$$P_T = \frac{1}{T} \int_0^T I_T \cdot V_T(I_T) dt$$

Fig. 17 Relationships for power loss

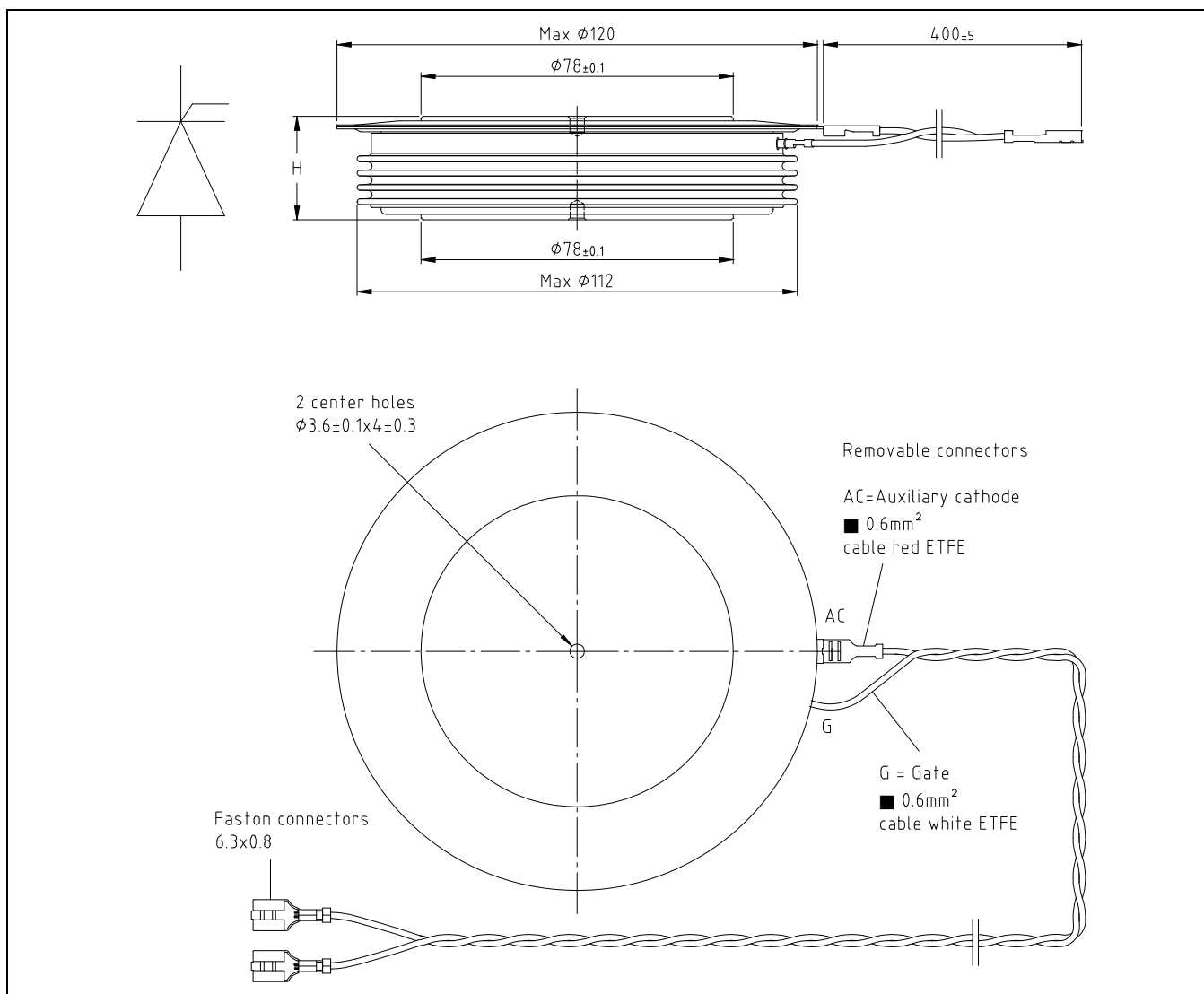

**Fig. 18** Device Outline Drawing

### Related documents:

5SYA 2020	Design of RC-Snubber for Phase Control Applications
5SYA 2049	Voltage definitions for phase control thyristors and diodes
5SYA 2051	Voltage ratings of high power semiconductors
5SYA 2034	Gate-Drive Recommendations for PCT's
5SYA 2036	Recommendations regarding mechanical clamping of Press Pack High Power Semiconductors
5SZK 9104	Specification of environmental class for pressure contact diodes, PCTs and GTO, STORAGE available on request, please contact factory
5SZK 9105	Specification of environmental class for pressure contact diodes, PCTs and GTO, TRANSPORTATION available on request, please contact factory

Please refer to <http://www.abb.com/semiconductors> for current version of documents.

**ABB Switzerland Ltd, Semiconductors reserves the right to change specifications without notice.**



**ABB Switzerland Ltd**  
**Semiconductors**  
 Fabrikstrasse 3  
 CH-5600 Lenzburg, Switzerland

Doc. No. 5SYA1008-05 Jan. 11

Telephone +41 (0)58 586 1419  
 Fax +41 (0)58 586 1306  
 Email [abbsem@ch.abb.com](mailto:abbsem@ch.abb.com)  
 Internet [www.abb.com/semiconductors](http://www.abb.com/semiconductors)