

# TIP29, A, B, C (NPN), TIP30, A, B, C (PNP)

## Complementary Silicon Plastic Power Transistors

Designed for use in general purpose amplifier and switching applications. Compact TO-220 package.

### Features

- These Devices are Pb-Free and are RoHS Compliant\*

### MAXIMUM RATINGS

Rating	Symbol	Value	Unit
Collector – Emitter Voltage TIP29G, TIP30G TIP29AG, TIP30AG TIP29BG, TIP30BG TIP29CG, TIP30CG	$V_{CEO}$	40 60 80 100	Vdc
Collector – Base Voltage TIP29G, TIP30G TIP29AG, TIP30AG TIP29BG, TIP30BG TIP29CG, TIP30CG	$V_{CB}$	40 60 80 100	Vdc
Emitter – Base Voltage	$V_{EB}$	5.0	Vdc
Collector Current – Continuous	$I_C$	1.0	Adc
Collector Current – Peak	$I_{CM}$	3.0	Adc
Base Current	$I_B$	0.4	Adc
Total Power Dissipation @ $T_C = 25^\circ\text{C}$ Derate above $25^\circ\text{C}$	$P_D$	30 0.24	W W/ $^\circ\text{C}$
Total Power Dissipation @ $T_A = 25^\circ\text{C}$ Derate above $25^\circ\text{C}$	$P_D$	2.0 0.016	W W/ $^\circ\text{C}$
Unclamped Inductive Load Energy (Note 1)	E	32	mJ
Operating and Storage Junction Temperature Range	$T_J, T_{stg}$	-65 to +150	$^\circ\text{C}$

Stresses exceeding those listed in the Maximum Ratings table may damage the device. If any of these limits are exceeded, device functionality should not be assumed, damage may occur and reliability may be affected.

1. This rating based on testing with  $L_C = 20$  mH,  $R_{BE} = 100$   $\Omega$ ,  $V_{CC} = 10$  V,  $I_C = 1.8$  A, P.R.F = 10 Hz

### THERMAL CHARACTERISTICS

Characteristic	Symbol	Max	Unit
Thermal Resistance, Junction-to-Ambient	$R_{\theta JA}$	62.5	$^\circ\text{C/W}$
Thermal Resistance, Junction-to-Case	$R_{\theta JC}$	4.167	$^\circ\text{C/W}$

\*For additional information on our Pb-Free strategy and soldering details, please download the ON Semiconductor Soldering and Mounting Techniques Reference Manual, SOLDERRM/D.



ON Semiconductor®

[www.onsemi.com](http://www.onsemi.com)

## 1 AMPERE POWER TRANSISTORS COMPLEMENTARY SILICON 40, 60, 80, 100 VOLTS, 80 WATTS

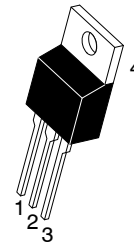
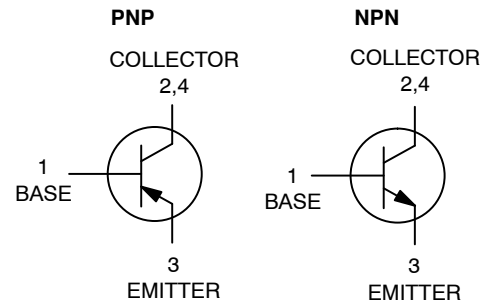

TO-220  
CASE 221A  
STYLE 1

### MARKING DIAGRAM



TIPxxx = Device Code:  
29, 29A, 29B, 29C  
30, 30A, 30B, 30C  
A = Assembly Location  
Y = Year  
WW = Work Week  
G = Pb-Free Package

### ORDERING INFORMATION

See detailed ordering and shipping information on page 4 of this data sheet.

## TIP29, A, B, C (NPN), TIP30, A, B, C (PNP)

### ELECTRICAL CHARACTERISTICS ( $T_C = 25^\circ\text{C}$ unless otherwise noted)

Characteristic	Symbol	Min	Max	Unit
<b>OFF CHARACTERISTICS</b>				
Collector-Emitter Sustaining Voltage ( $I_C = 30\text{ mAdc}$ , $I_B = 0$ ) (Note 2) TIP29G, TIP30G TIP29AG, TIP30AG TIP29BG, TIP30BG TIP29CG, TIP30CG	$V_{CEO(sus)}$	40 60 80 100	- - - -	Vdc
Collector Cutoff Current ( $V_{CE} = 30\text{ Vdc}$ , $I_B = 0$ ) TIP29G, TIP29AG, TIP30G, TIP30AG ( $V_{CE} = 60\text{ Vdc}$ , $I_B = 0$ ) TIP29BG, TIP29CG, TIP30BG, TIP30CG	$I_{CEO}$	- -	0.3 0.3	mAdc
Collector Cutoff Current ( $V_{CE} = 40\text{ Vdc}$ , $V_{EB} = 0$ ) TIP29G, TIP30G ( $V_{CE} = 60\text{ Vdc}$ , $V_{EB} = 0$ ) TIP29AG, TIP30AG ( $V_{CE} = 80\text{ Vdc}$ , $V_{EB} = 0$ ) TIP29BG, TIP30BG ( $V_{CE} = 100\text{ Vdc}$ , $V_{EB} = 0$ ) TIP29CG, TIP30CG	$I_{CES}$	- - - -	200 200 200 200	$\mu\text{Adc}$
Emitter Cutoff Current ( $V_{BE} = 5.0\text{ Vdc}$ , $I_C = 0$ )	$I_{EBO}$	-	1.0	mAdc
<b>ON CHARACTERISTICS (Note 2)</b>				
DC Current Gain ( $I_C = 0.2\text{ Adc}$ , $V_{CE} = 4.0\text{ Vdc}$ ) ( $I_C = 1.0\text{ Adc}$ , $V_{CE} = 4.0\text{ Vdc}$ )	$h_{FE}$	40 15	- 75	-
Collector-Emitter Saturation Voltage ( $I_C = 1.0\text{ Adc}$ , $I_B = 125\text{ mAdc}$ )	$V_{CE(sat)}$	-	0.7	Vdc
Base-Emitter On Voltage ( $I_C = 1.0\text{ Adc}$ , $V_{CE} = 4.0\text{ Vdc}$ )	$V_{BE(on)}$	-	1.3	Vdc
<b>DYNAMIC CHARACTERISTICS</b>				
Current-Gain - Bandwidth Product (Note 3) ( $I_C = 200\text{ mAdc}$ , $V_{CE} = 10\text{ Vdc}$ , $f_{test} = 1.0\text{ MHz}$ )	$f_T$	3.0	-	MHz
Small-Signal Current Gain ( $I_C = 0.2\text{ Adc}$ , $V_{CE} = 10\text{ Vdc}$ , $f = 1.0\text{ kHz}$ )	$h_{fe}$	20	-	-

Product parametric performance is indicated in the Electrical Characteristics for the listed test conditions, unless otherwise noted. Product performance may not be indicated by the Electrical Characteristics if operated under different conditions.

2. Pulse Test: Pulse Width  $\leq 300\ \mu\text{s}$ , Duty Cycle  $\leq 2.0\%$

3.  $f_T = |h_{fe}| \cdot f_{test}$

## TIP29, A, B, C (NPN), TIP30, A, B, C (PNP)

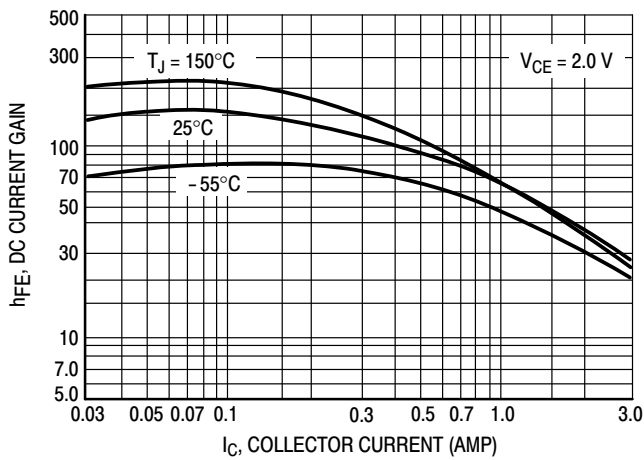

**Figure 1. DC Current Gain**

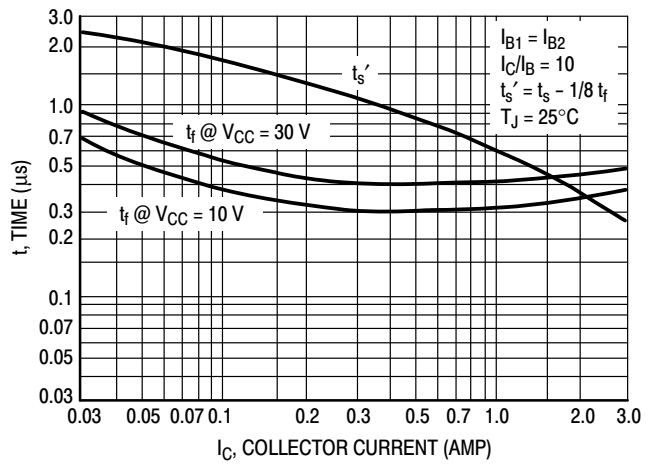

**Figure 2. Turn-Off Time**

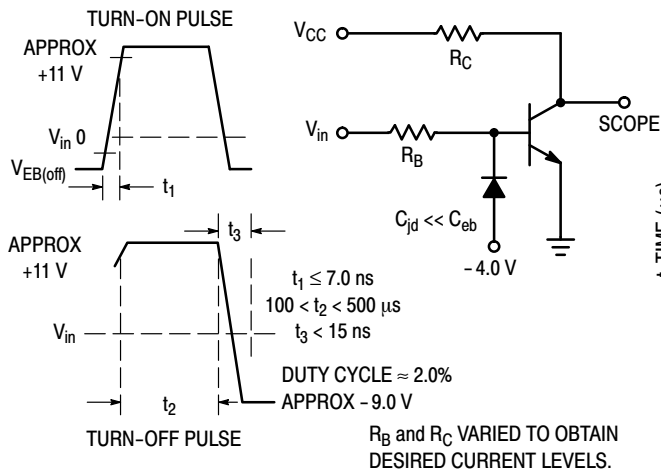

**Figure 3. Switching Time Equivalent Circuit**

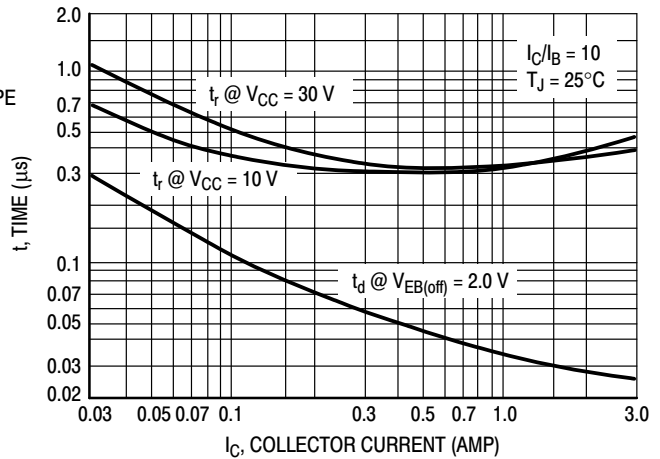

**Figure 4. Turn-On Time**

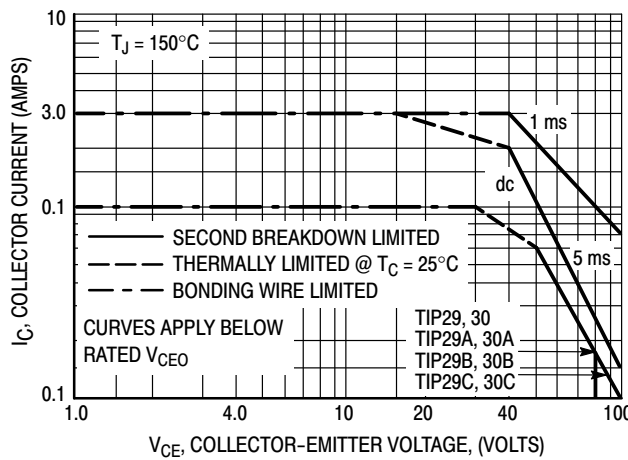

**Figure 5. Active Region Safe Operating Area**

There are two limitations on the power handling ability of a transistor: average junction temperature and second breakdown. Safe operating area curves indicate  $I_C - V_{CE}$  operation; i.e., the transistor must not be subjected to greater dissipation than the curves indicate.

The data of Figure 5 is based on  $T_{J(pk)} = 150^\circ\text{C}$ ;  $T_C$  is variable depending on conditions. Second breakdown pulse limits are valid for duty cycles to 10% provided  $T_{J(pk)} \leq 150^\circ\text{C}$ . At high case temperatures, thermal limitations will reduce the power that can be handled to values less than the limitations imposed by second breakdown.

## TIP29, A, B, C (NPN), TIP30, A, B, C (PNP)

### ORDERING INFORMATION

Device	Package	Shipping
TIP29G	TO-220 (Pb-Free)	50 Units / Rail
TIP29AG	TO-220 (Pb-Free)	50 Units / Rail
TIP29BG	TO-220 (Pb-Free)	50 Units / Rail
TIP29CG	TO-220 (Pb-Free)	50 Units / Rail
TIP30G	TO-220 (Pb-Free)	50 Units / Rail
TIP30AG	TO-220 (Pb-Free)	50 Units / Rail
TIP30BG	TO-220 (Pb-Free)	50 Units / Rail
TIP30CG	TO-220 (Pb-Free)	50 Units / Rail

# TIP29, A, B, C (NPN), TIP30, A, B, C (PNP)

## PACKAGE DIMENSIONS

### TO-220 CASE 221A-09 ISSUE AH

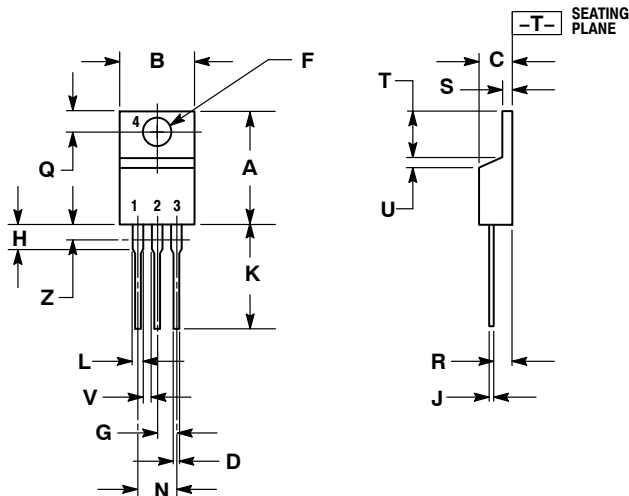

**NOTES:**

1. DIMENSIONING AND TOLERANCING PER ANSI Y14.5M, 1982.
2. CONTROLLING DIMENSION: INCH.
3. DIMENSION Z DEFINES A ZONE WHERE ALL BODY AND LEAD IRREGULARITIES ARE ALLOWED.

DIM	INCHES		MILLIMETERS	
	MIN	MAX	MIN	MAX
A	0.570	0.620	14.48	15.75
B	0.380	0.415	9.66	10.53
C	0.160	0.190	4.07	4.83
D	0.025	0.038	0.64	0.96
F	0.142	0.161	3.61	4.09
G	0.095	0.105	2.42	2.66
H	0.110	0.161	2.80	4.10
J	0.014	0.024	0.36	0.61
K	0.500	0.562	12.70	14.27
L	0.045	0.060	1.15	1.52
N	0.190	0.210	4.83	5.33
Q	0.100	0.120	2.54	3.04
R	0.080	0.110	2.04	2.79
S	0.045	0.055	1.15	1.39
T	0.235	0.255	5.97	6.47
U	0.000	0.050	0.00	1.27
V	0.045	---	1.15	---
Z	---	0.080	---	2.04

**STYLE 1:**

- PIN 1. BASE
2. COLLECTOR
3. EMITTER
4. COLLECTOR

ON Semiconductor and the  are registered trademarks of Semiconductor Components Industries, LLC (SCILLC) or its subsidiaries in the United States and/or other countries. SCILLC owns the rights to a number of patents, trademarks, copyrights, trade secrets, and other intellectual property. A listing of SCILLC's product/patent coverage may be accessed at [www.onsemi.com/site/pdf/Patent-Marking.pdf](http://www.onsemi.com/site/pdf/Patent-Marking.pdf). SCILLC reserves the right to make changes without further notice to any products herein. SCILLC makes no warranty, representation or guarantee regarding the suitability of its products for any particular purpose, nor does SCILLC assume any liability arising out of the application or use of any product or circuit, and specifically disclaims any and all liability, including without limitation special, consequential or incidental damages. "Typical" parameters which may be provided in SCILLC data sheets and/or specifications can and do vary in different applications and actual performance may vary over time. All operating parameters, including "Typicals" must be validated for each customer application by customer's technical experts. SCILLC does not convey any license under its patent rights nor the rights of others. SCILLC products are not designed, intended, or authorized for use as components in systems intended for surgical implant into the body, or other applications intended to support or sustain life, or for any other application in which the failure of the SCILLC product could create a situation where personal injury or death may occur. Should Buyer purchase or use SCILLC products for any such unintended or unauthorized application, Buyer shall indemnify and hold SCILLC and its officers, employees, subsidiaries, affiliates, and distributors harmless against all claims, costs, damages, and expenses, and reasonable attorney fees arising out of, directly or indirectly, any claim of personal injury or death associated with such unintended or unauthorized use, even if such claim alleges that SCILLC was negligent regarding the design or manufacture of the part. SCILLC is an Equal Opportunity/Affirmative Action Employer. This literature is subject to all applicable copyright laws and is not for resale in any manner.

### PUBLICATION ORDERING INFORMATION

**LITERATURE FULFILLMENT:**

Literature Distribution Center for ON Semiconductor  
P.O. Box 5163, Denver, Colorado 80217 USA  
Phone: 303-675-2175 or 800-344-3860 Toll Free USA/Canada  
Fax: 303-675-2176 or 800-344-3867 Toll Free USA/Canada  
Email: [orderlit@onsemi.com](mailto:orderlit@onsemi.com)

**N. American Technical Support:** 800-282-9855 Toll Free  
USA/Canada  
**Europe, Middle East and Africa Technical Support:**  
Phone: 421 33 790 2910  
**Japan Customer Focus Center**  
Phone: 81-3-5817-1050

**ON Semiconductor Website:** [www.onsemi.com](http://www.onsemi.com)

**Order Literature:** <http://www.onsemi.com/orderlit>

For additional information, please contact your local Sales Representative