

## Transient Voltage Suppressor

**Breakdown Voltage 5.0 to 75 Volts**  
**Peak Pulse Power 500 Watts**

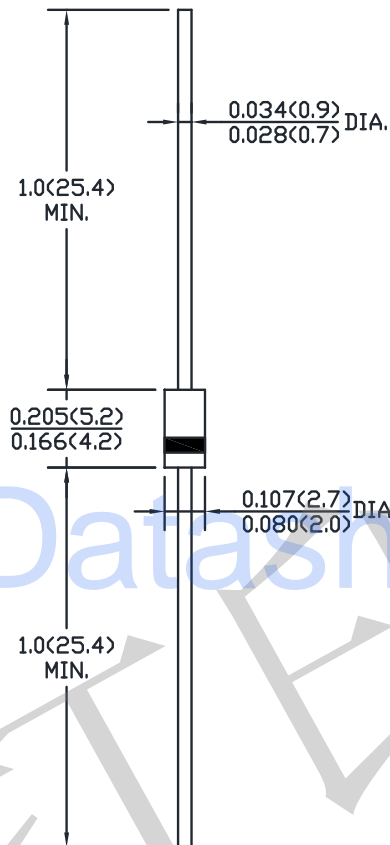

**CASE: DO-204AL (DO-41)**



**Dimensions in inches and (millimeters)**

### Features

- Breakdown Voltages ( $V_{BR}$ ) from 5.0 to 75V
- 500W peak pulse power capability with a 10/1000 $\mu$ s waveform, repetitive rate (duty cycle):0.01%
- Low incremental surge resistance
- Fast Response Time
- Excellent clamping capability
- High temperature soldering guaranteed: 265 $^{\circ}$ C /10 seconds, 0.375" (9.5mm) lead length, 5lbs. (2.3kg) tension

### Application

- Use in sensitive electronics protection against voltage transients induced by inductive load switching and lighting on ICs, MOSFE, signal lines of sensor units for consumer, computer, industrial, automotive and telecommunication

### Mechanical Data

- **Case:** Void-free transfer molded thermosetting epoxy body meeting UL94V-O
- **Terminals:** Tin-Lead or ROHS Compliant annealed matte-Tin plating readily solderable per MIL-STD-750, Method 2026
- **Marking:** Part number and cathode band
- **Polarity:** Cathode indicated by band
- **Weight:** 0.3g (Approximately)

### Maximum Ratings and Electrical Characteristics @ 25 $^{\circ}$ C unless otherwise specified

Symbol	Conditions	Value	Unit
$P_{PPM}$	Peak pulse power capability with a 10/1000 $\mu$ s	500	W
$I_{PPM}$	Peak pulse current with a 10/1000 $\mu$ s	SEE TABLE1	A
$P_{M(AV)}$	Steady state power dissipation at $T_L=75^{\circ}$ C ,Lead lengths 0.375"(10mm)	2.5	W
$V_F$	Maximum instantaneous forward voltage at 30A	3.5	V
$T_J, T_{STG}$	Operating and Storage Temperature	-65 to +150	$^{\circ}$ C

**Electrical Characteristics @ 25°C (Unless Otherwise Noted) TABLE1**

Microsemi Part Number	Reverse Stand Off Voltage (Note1)	Breakdown Voltage $V_{BR}$ @ $I_{BR}$ 1.0mA	Maximum Standby current $I_D$ @ $V_{WM}$	Maximum Peak Pulse Current	Maximum Clamping Voltage $V_C$ @ $I_{PP}=5.0A$ (Note2)	Maximum Capacitance @ 0 Volts pF	Working Inverse Blocking Voltage	Inverse Blocking Leakage Current @ $V_{WIB}$	Peak Inverse Blocking Voltage
	$V_{WM}(V)$	$V_{BR}(V)$	$I_D(\mu A)$	$I_{PP}(A)$	$V_C(V)$	$C(pF)$	$V_{WIB}(V)$	$I_{IB}(\mu A)$	$V_{PIB}(V)$
SAC5.0	5.0	7.60	300	44.0	10.0	30	75	10	100
SAC6.0	6.0	7.90	300	41.0	11.2	30	75	10	100
SAC7.0	7.0	8.33	300	38.0	12.6	30	75	10	100
SAC8.0	8.0	8.89	100	36.0	13.4	30	75	10	100
SAC8.5	7.5	9.44	50	34.0	14.0	30	75	10	100
SAC10	10.0	11.1	5.0	29.0	16.3	30	75	10	100
SAC12	12.0	13.3	5.0	25.0	19.0	30	75	10	100
SAC15	15.0	16.7	5.0	20.0	23.6	30	75	10	100
SAC18	18.0	20.0	5.0	15.0	28.8	30	75	10	100
SAC22	22.0	24.4	5.0	14.0	35.4	30	75	10	100
SAC26	26.0	28.9	5.0	11.1	42.3	30	75	10	100
SAC36	36.0	40.0	5.0	8.6	60.0	30	75	10	100
SAC45	45.0	50.0	5.0	6.8	77.0	30	150	10	200
SAC50	50.0	55.5	5.0	5.8	88.0	30	150	10	200
SAC75	75.0	83.3	5.0	4.1	121.0	30	150	10	200

Note1: A transient voltage suppressor is normally selected according to voltage ( $V_{WM}$ ), which should be equal to or greater than the dc or continuous peak operating voltage level.

Note2: Test in TVS avalanche direction. Do not pulse in "forward" direction. See section for "Schematic Applications" herein.

### Characteristic Curve

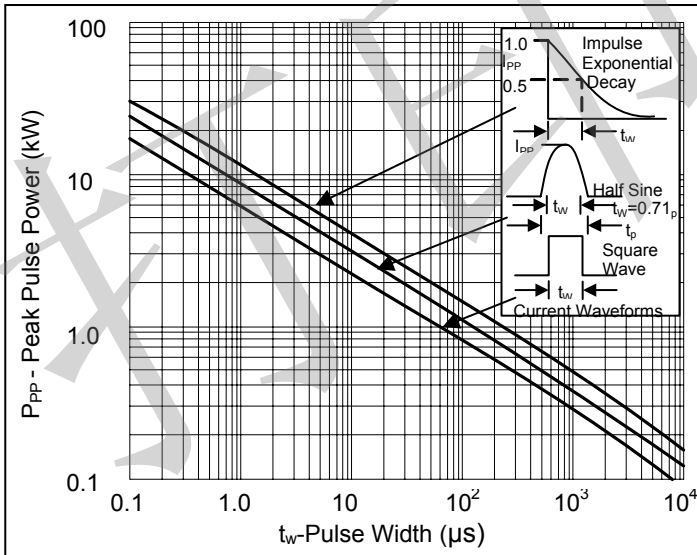

**Fig. 1 Peak Pulse Power vs. Pulse Time**

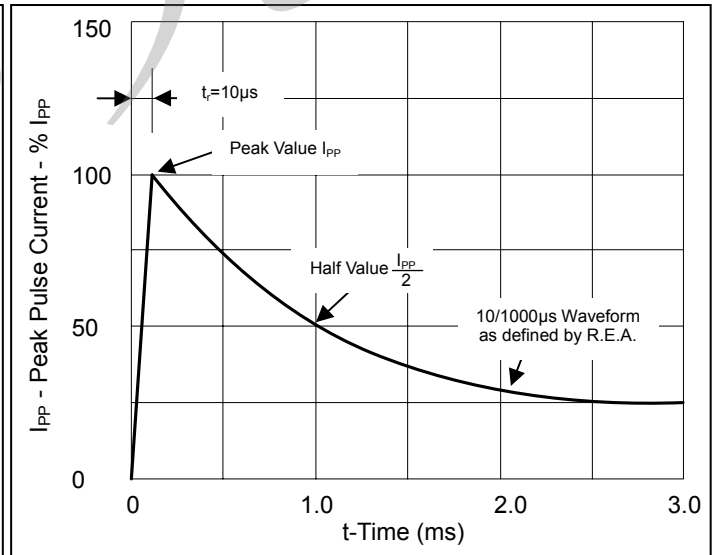

**Fig. 2 Pulse Waveform for Exponential Surge**

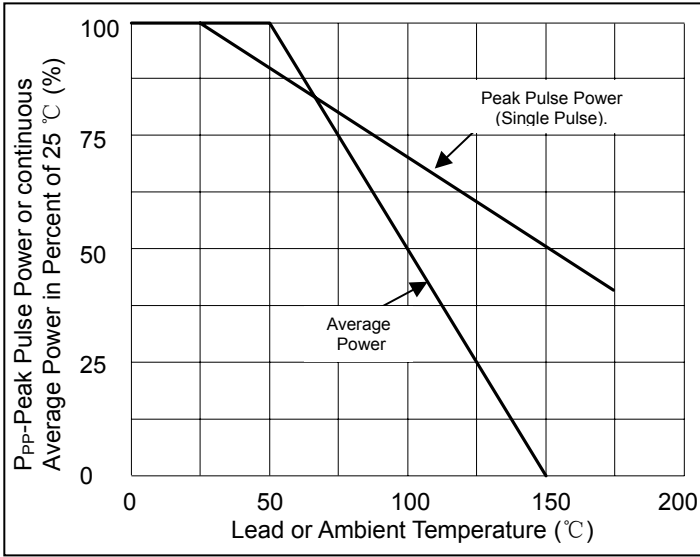

**Fig.3 Derating Curve**

### Schematic Applications

The TVS low capacitance device configuration is shown in Fig.4. As a further option for unidirectional applications, an additional low capacitance rectifier diode may be used in parallel in the same polarity direction as the TVS as shown in Fig.5. In applications where random high voltage transients occur, this will prevent reverse transients from damaging the internal low capacitance rectifier diode and also provide a low voltage conducting direction. The added rectifier diode should be of similar low capacitance and also have a higher reverse voltage rating than the TVS clamping voltage  $V_C$ . If using two (2) low capacitance TVS devices in also provided. The unidirectional and bidirectional configurations in Fig.5 and 6 will both in twice the capacitance of Fig.4

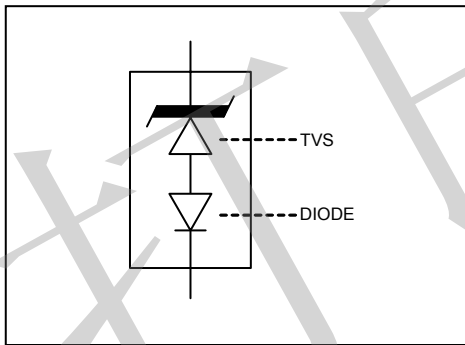

**Fig.4 TVS with internal Low Capacitance Diode**

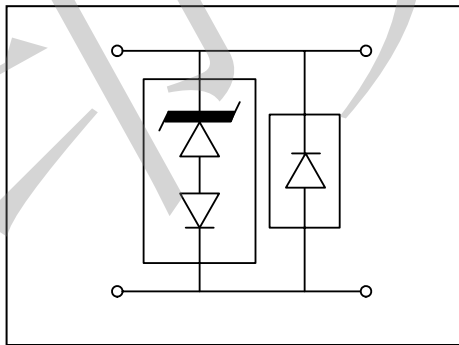

**Fig.5 Optional Unidirectional configuration (TVS and separate rectifier diode in parallel)**

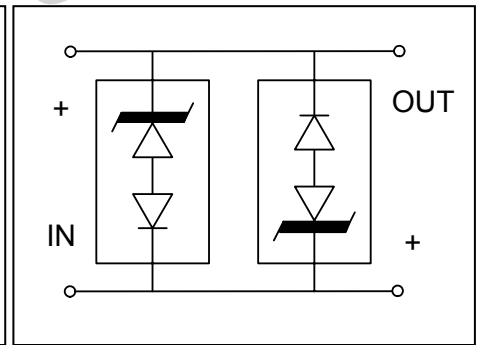

**Fig.6 Optional Bidirectional configuration (two TVS and devices in anti-parallel)**