



TIGER EYE
SYSTEM

SFM-110-02-L-D-A

SFML-125-T2-L-D-LC



SFML-115-T2-L-D-LC

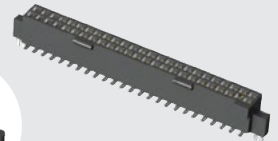

(1.27 mm) .050"

SMT & THROUGH-HOLE TIGER EYE™ SOCKET

SPECIFICATIONS

For complete specifications and recommended PCB layouts see www.samtec.com?SFM or www.samtec.com?SFML

Insulator Material:
Black Liquid Crystal Polymer
Plating:
Au or Sn over 50 μm (1.27 μm) Ni
Current Rating (SFM/TFM):
3.2 A per pin
(2 pins powered)
Voltage Rating:
250 VAC mated with TFM
Operating Temp Range:
-55 °C to +125 °C
Insertion Depth:
(3.05 mm) .120" to
(4.06 mm) .160"
Wiping Distance:
(0.38 mm) .015"
Normal Force:
Standard= 132 g (1.29 N) avg.;
LIF= 90 g (0.88 N) avg.
Max Cycles:
10,000 with 30 μm (0.76 μm) Au
(Call Samtec for E.L.P.™
plating option)
RoHS Compliant:
Yes

SFM Board Mates:

TFM

SFM Cable Mates:

TFSD, TFSS

SFML Board Mates:

TFML

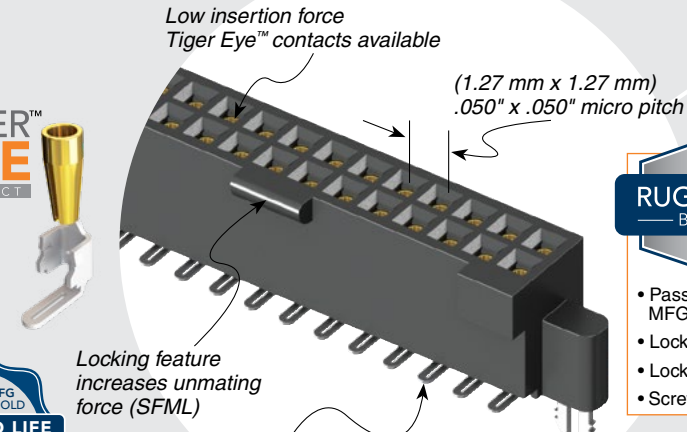

RUGGEDIZED
BY SAMTEC

- Passes 10 Year MFG
- Locking option
- Locking clip option
- Screw Down option

HIGH-SPEED CHANNEL PERFORMANCE

Rating based on Samtec reference channel. For full SI performance data visit Samtec.com or contact SIG@samtec.com

8
Gbps

PROCESSING

Lead-Free Solderable:
Yes
SMT Lead Coplanarity:
(0.10 mm) .004" max (05-25)
(0.15 mm) .006" max (30-50)*
*(.004" stencil solution may be available; contact IPG@samtec.com)

RECOGNITIONS

For complete scope of recognitions see www.samtec.com/quality



TYPE STRIP	1	NO. PINS PER ROW	LEAD STYLE
------------	---	------------------	------------

SFM
= Standard
SFML
= Locking

03, 04, 06, 08
(SFM only)
05, 07, 10, 15, 20, 25, 30, 35, 40, 45, 50
(Standard sizes)

(Surface Mount)

-02
= Tiger Eye™ Contact (BeCu)
-L2
= Low Insertion Force Tiger Eye™ Contact (BeCu)

-T2
= Tiger Eye™ LITE Contact (Phosphor Bronze)

(Through-hole)

-01, -03
= Tiger Eye™ Contact (BeCu)
-L1, -L3
= Low Insertion Force Tiger Eye™ Contact (BeCu)

-T1
= Tiger Eye™ LITE Contact (Phosphor Bronze)

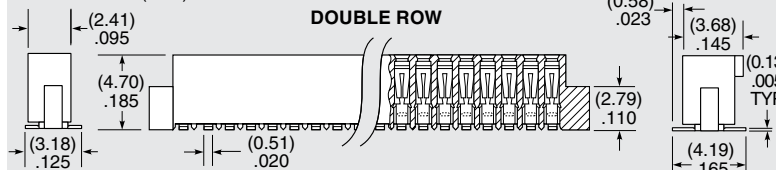
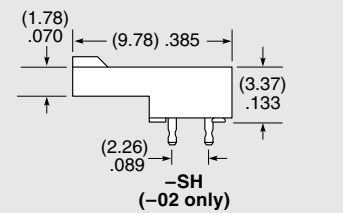
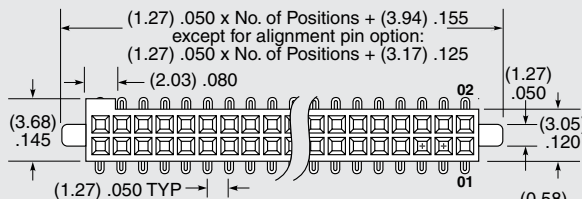
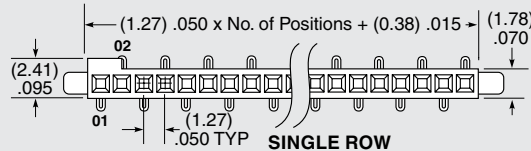

Note:
Some sizes, styles and options are non-standard, non-returnable.

Due to technical progress, all designs, specifications and components are subject to change without notice.

WWW.SAMTEC.COM

All parts within this catalog are built to Samtec's specifications. Customer specific requirements must be approved by Samtec and identified in a Samtec customer-specific drawing to apply.

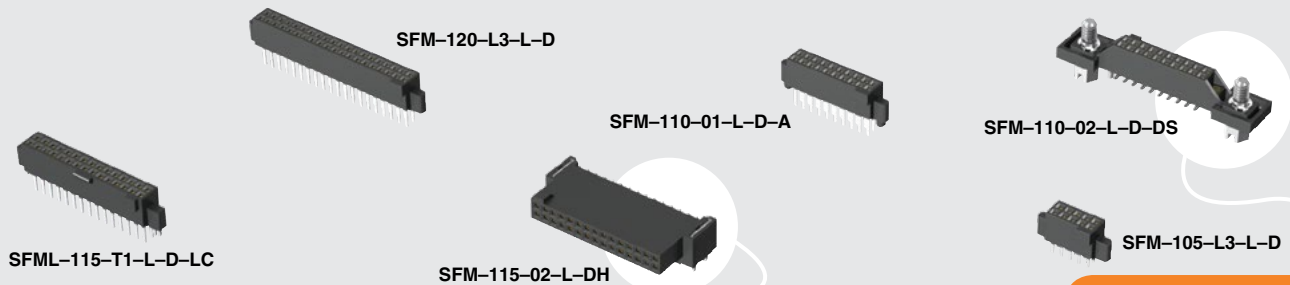

SFM, SFML SERIES

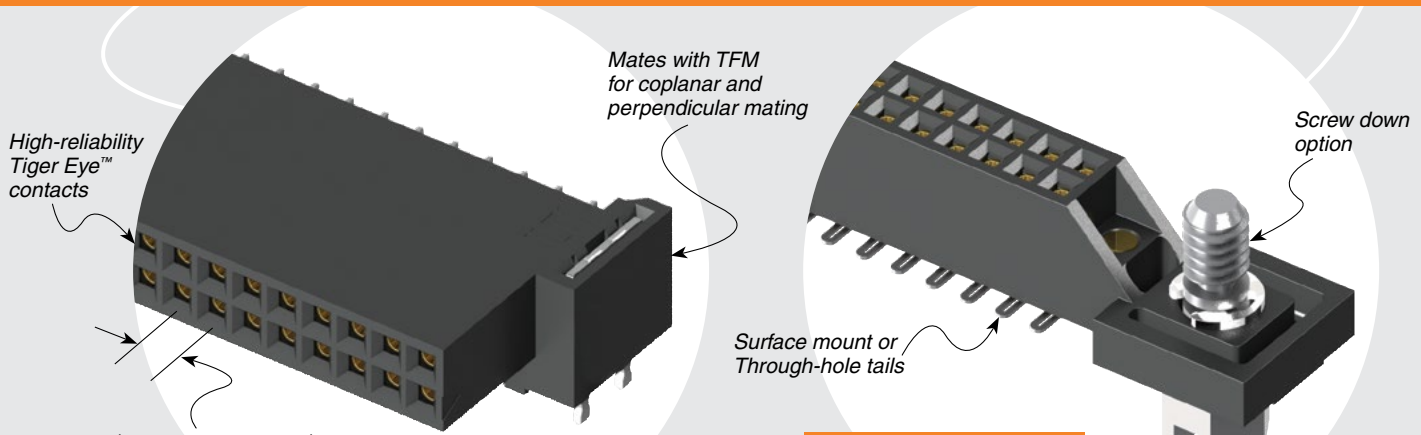

(1.27 mm x 1.27 mm)
.050" x .050" micro pitch

OTHER SOLUTIONS

- Lower cost plating options. See SFC Series.

ALSO AVAILABLE (MOQ Required)

- Solder nail option
- Other sizes
- Other platings

PLATING OPTION

-L
= 10 μ" (0.25 μm) Gold on contact, Matte Tin on tail
(Call Samtec for E.L.P.™ plating option)

LEAD STYLE	A	B
-01, -L1, -T1	(3.05) .120	(0.51) .020
-03, -L3	(1.91) .075	(0.41) .016

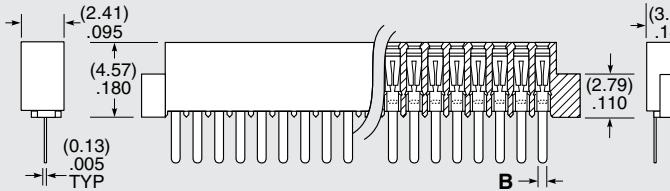
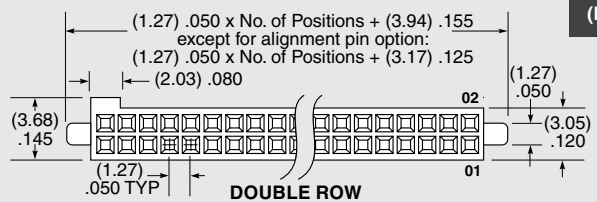
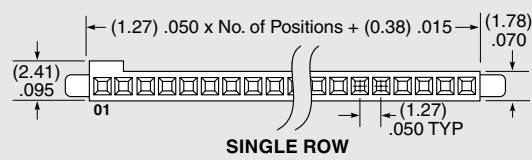

ROW OPTION

-S
= Single Row (SFM only)

-D
= Double Row

-SH
= Single Horizontal (05 thru 30 positions only) (SFM only) (Lead style -02 only)

-DH
= Double Horizontal (05 thru 30 positions only) (SFM only) (Lead style -02 only)

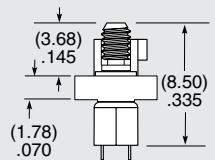

OPTION

Specify only -A, -LC or -DS (Not available with -DH, -SH)

-A
= Alignment Pin (Available with all lead styles)

-LC
= Locking Clip (Available with all lead styles) (Manual placement required)

-DS
= Dual Screw Down for (1.60 mm) .062" PCB (05 thru 40 positions only) (Lead styles -01, -02 & -03 only) (Requires -D row option) (Not available with SFML) (Mates with TFM-DS option) (Not available with -A, -LC, -K, -P, -TR)

Specify only -K or -P (Lead styles -02, -L2, -T2 only)

-K
= Polyimide film Pick & Place Pad (Not available with -DH, -SH)

-P
= Plastic Pick & Place Pad (Not available with -DH, -SH)

Specify -TR last (Lead styles -02, -L2, -T2 only)

-TR
= Tape & Reel (Required callout for -DH, -SH)

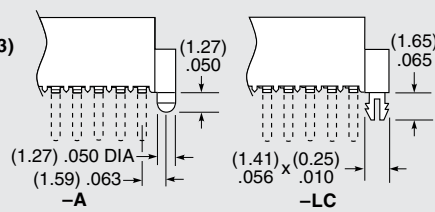

Due to technical progress, all designs, specifications and components are subject to change without notice.