

# Chip Beads

For signal line

## MMZ series

|       |           |                   |
|-------|-----------|-------------------|
| Type: | MMZ0402   | 0402[01005 inch]* |
|       | MMZ0603   | 0603[0201 inch]   |
|       | MMZ1005   | 1005[0402 inch]   |
|       | MMZ1608   | 1608[0603 inch]   |
|       | MMZ2012   | 2012[0805 inch]   |
|       | MMZ1005-E | 1005[0402 inch]   |

\* Dimensions Code JIS[EIA]

Issue date: November 2011

- All specifications are subject to change without notice.
- Conformity to RoHS Directive: This means that, in conformity with EU Directive 2002/95/EC, lead, cadmium, mercury, hexavalent chromium, and specific bromine-based flame retardants, PBB and PBDE, have not been used, except for exempted applications.

# Chip Beads

## For Signal Line

Conformity to RoHS Directive

### MMZ Series MMZ0402

#### FEATURES

- It is super small size(L0.4×W0.2×T0.2mm).
- It prevents radiated noise from high-speed signal lines.
- Maintain impedance to high frequency band.
- Because it adopts silver in internal electrode, it is low DC resistance.
- Because it is not generate of cross talk with closed magnetic circuit structural design, high density assembly is possible.
- It is a product conforming to RoHS directive.

#### APPLICATIONS

Removal of signal line noises of cellular phones, portable audio players, various modules, etc.

#### PRODUCT IDENTIFICATION

MMZ 0402 S 121 C T   
 (1) (2) (3) (4) (5) (6) (7)

- (1) Series name
- (2) Dimensions L×W
- (3) Type name
- (4) Impedance  
121:120Ω at 100MHz
- (5) Characteristic type
- (6) Packaging style  
T: Taping
- (7) TDK internal code

#### HANDLING AND PRECAUTIONS

- Before soldering, be sure to preheat components. The preheating temperature should be set so that the temperature difference between the solder temperature and product temperature does not exceed 150°C.
- After mounting components onto the printed circuit board, do not apply stress through board bending or mishandling.
- Do not expose the inductors to stray magnetic fields.
- Avoid static electricity discharge during handling.

#### SHAPES AND DIMENSIONS/RECOMMENDED PC BOARD PATTERN

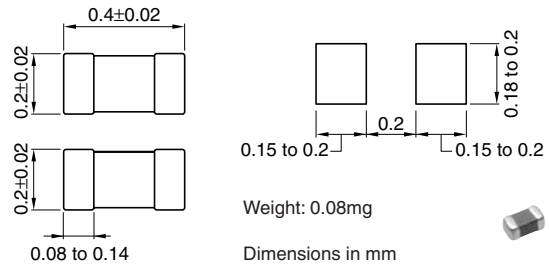

#### TEMPERATURE RANGES

|                   |               |
|-------------------|---------------|
| Operating/storage | -55 to +125°C |
|-------------------|---------------|

#### PACKAGING STYLE AND QUANTITIES

|                 |                   |
|-----------------|-------------------|
| Packaging style | Quantity          |
| Taping          | 20000 pieces/reel |

#### RECOMMENDED SOLDERING CONDITION REFLOW SOLDERING

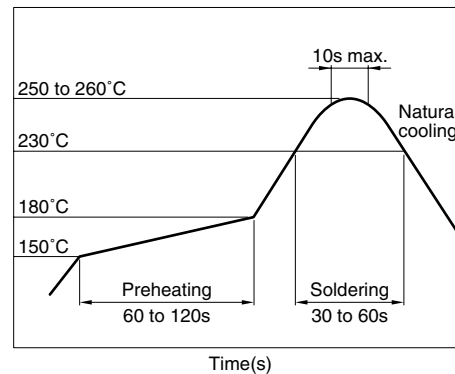

#### ELECTRICAL CHARACTERISTICS

| Part No.     | Impedance<br>(Ω)[100MHz]* | DC resistance<br>(Ω)max. | Rated current<br>(mA)max. |
|--------------|---------------------------|--------------------------|---------------------------|
| MMZ0402S100C | 10±5Ω                     | 0.10                     | 500                       |
| MMZ0402S700C | 70±25%                    | 0.45                     | 260                       |
| MMZ0402S121C | 120±25%                   | 0.70                     | 210                       |

\* Test equipment: E4991A or equivalent  
 Test tool: 16197 or equivalent  
 Test temperature: 25±10°C

• Conformity to RoHS Directive: This means that, in conformity with EU Directive 2002/95/EC, lead, cadmium, mercury, hexavalent chromium, and specific bromine-based flame retardants, PBB and PBDE, have not been used, except for exempted applications.

• Please contact our Sales office when your application is considered the following:  
 The device's failure or malfunction may directly endanger human life (e.g. application for automobile/aircraft/medical/nuclear power devices, etc.)

• All specifications are subject to change without notice.

**TYPICAL ELECTRICAL CHARACTERISTICS**  
**Z FREQUENCY CHARACTERISTICS(DIFFERS ACCORDING TO SERIES)**  
**MMZ0402S SERIES**

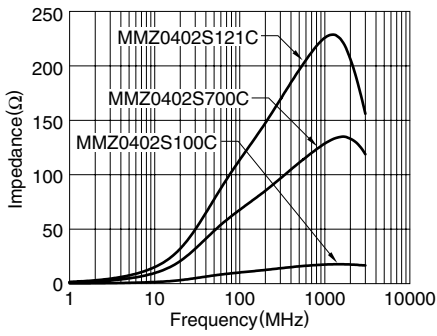

**Z, X, R vs. FREQUENCY CHARACTERISTICS**  
**MMZ0402S100C**

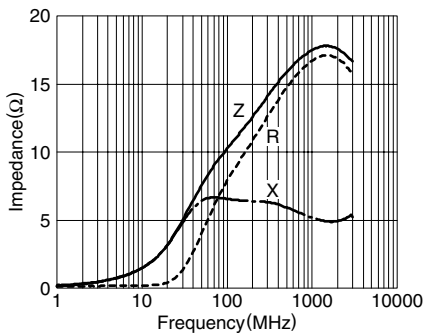

**MMZ0402S700C**

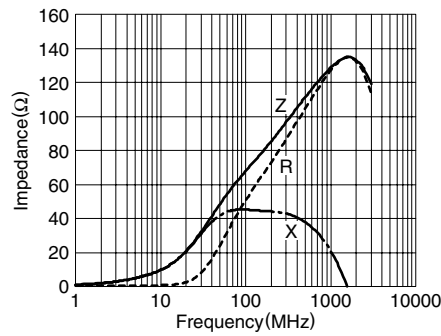

**MMZ0402S121C**

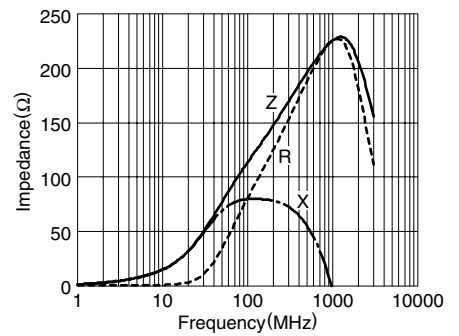

**PACKAGING STYLES**

**REEL DIMENSIONS**

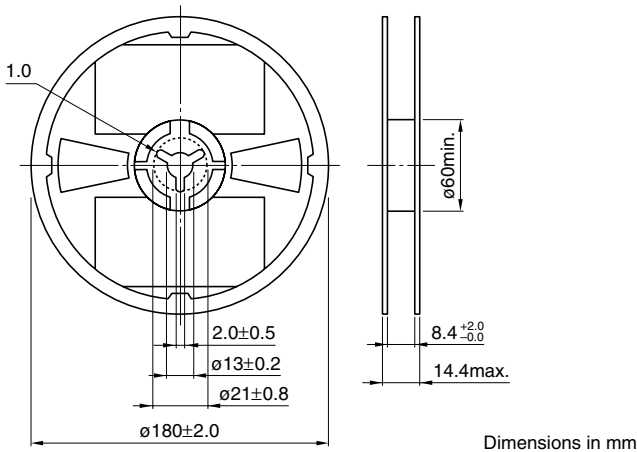

**TAPE DIMENSIONS**

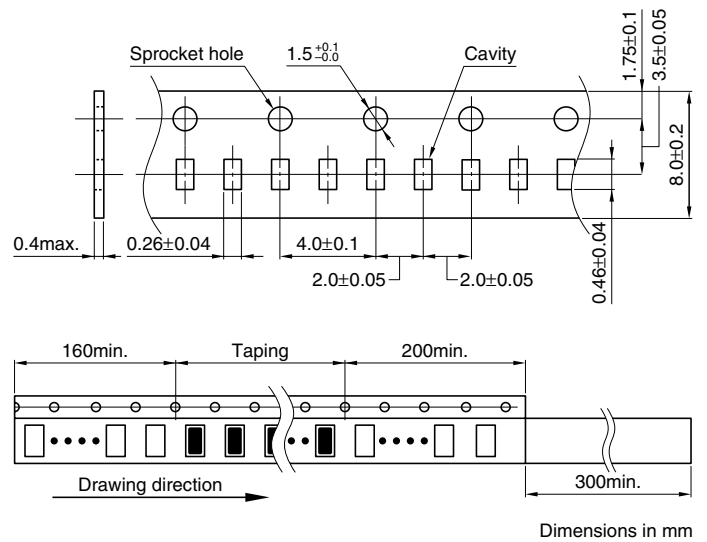

• All specifications are subject to change without notice.

# Chip Beads For Signal Line

Conformity to RoHS Directive

## MMZ Series MMZ0603

### FEATURES

- This is a multilayered chip bead product with dimensions of L0.6×W0.3×T0.3mm.
- The product is magnetically shielded, allowing high density mounting.
- We refined the rules for internal conductor design to reduce floating capacity between conductors, which in turn has contributed to a dramatic improvement in high frequency characteristics. We have also been able to expand and reinforce the EMI suppression in the GHz range.
- It is a product conforming to RoHS directive.

### APPLICATIONS

Removal of signal line noises of cellular phones, portable audio players, various modules, DSCs, portable game machines, etc.

### PRODUCT IDENTIFICATION

|     |      |     |     |     |     |     |
|-----|------|-----|-----|-----|-----|-----|
| MMZ | 0603 | S   | 121 | C   | T   | □□□ |
| (1) | (2)  | (3) | (4) | (5) | (6) | (7) |

- (1) Series name
- (2) Dimensions L×W
- (3) Type name
- (4) Impedance  
121:120Ω at 100MHz
- (5) Characteristic type
- (6) Packaging style  
T:Taping
- (7) TDK internal code

### HANDLING AND PRECAUTIONS

- Before soldering, be sure to preheat components. The preheating temperature should be set so that the temperature difference between the solder temperature and product temperature does not exceed 150°C.
- After mounting components onto the printed circuit board, do not apply stress through board bending or mishandling.
- Do not expose the inductors to stray magnetic fields.
- Avoid static electricity discharge during handling.
- When hand soldering, apply the soldering iron to the printed circuit board only. Temperature of the iron tip should not exceed 350°C. Soldering time should not exceed 3 seconds.

### MATERIAL CHARACTERISTICS

**S material:** Standard type that features impedance characteristics similar to those of a typical ferrite core.

For signal line applications in which the blocking region is near 100MHz. Impedance values selected for effectiveness at 40 to 300MHz.

**Y material:** High frequency range type intended for the 100MHz region and above.

For signal line applications in which the signal frequency is far from the cutoff frequency. Impedance values selected for effectiveness at 80 to 400MHz.

**D material:** For applications calling for low insertion loss at low frequencies and sharply increasing impedance at high frequencies. Designed for high impedance at high frequencies (300MHz to 1GHz) for signal line applications.

**F material:** This new product inherits the characteristic of our D-material, namely its sharp impedance rise time, and its impedance peak frequency has been shifted higher into range. The product offers excellent noise suppression from 600MHz to as high as in the GHz range.

### TYPICAL MATERIAL CHARACTERISTICS

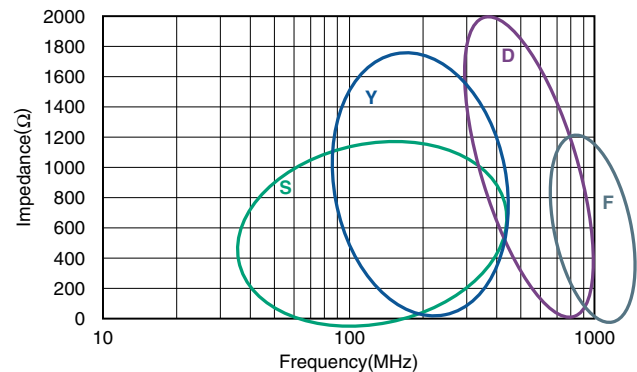

• Conformity to RoHS Directive: This means that, in conformity with EU Directive 2002/95/EC, lead, cadmium, mercury, hexavalent chromium, and specific bromine-based flame retardants, PBB and PBDE, have not been used, except for exempted applications.

• Please contact our Sales office when your application is considered the following:  
The device's failure or malfunction may directly endanger human life (e.g. application for automobile/aircraft/medical/nuclear power devices, etc.)

• All specifications are subject to change without notice.

**SHAPES AND DIMENSIONS/RECOMMENDED PC BOARD PATTERN**

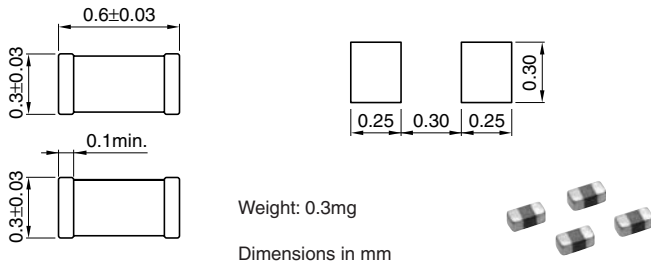

**ELECTRICAL CHARACTERISTICS**

| Part No.     | Impedance (Ω)[100MHz]* | DC resistance (Ω)max. | Rated current (mA)max. |
|--------------|------------------------|-----------------------|------------------------|
| MMZ0603S100C | 10±5Ω                  | 0.09                  | 500                    |
| MMZ0603S800C | 80±25%                 | 0.30                  | 200                    |
| MMZ0603S121C | 120±25%                | 0.45                  | 200                    |
| MMZ0603S241C | 240±25%                | 0.57                  | 200                    |
| MMZ0603S471C | 470±25%                | 1.30                  | 100                    |
| MMZ0603S601C | 600±25%                | 1.45                  | 100                    |
| MMZ0603Y121C | 120±25%                | 0.39                  | 200                    |
| MMZ0603Y241C | 240±25%                | 0.80                  | 200                    |
| MMZ0603Y471C | 470±25%                | 1.40                  | 200                    |
| MMZ0603Y601C | 600±25%                | 1.50                  | 200                    |
| MMZ0603D330C | 33±25%                 | 0.70                  | 100                    |
| MMZ0603D560C | 56±25%                 | 0.95                  | 100                    |
| MMZ0603D800C | 80±25%                 | 1.25                  | 100                    |
| MMZ0603F100C | 10±5Ω                  | 0.50                  | 200                    |
| MMZ0603F220C | 22±25%                 | 1.00                  | 200                    |
| MMZ0603F330C | 33±25%                 | 1.30                  | 150                    |

\* Test equipment: E4991A or equivalent  
Test tool: 16197 or equivalent  
Test temperature: 25±10°C

**TEMPERATURE RANGES**

|                   |               |
|-------------------|---------------|
| Operating/storage | -55 to +125°C |
|-------------------|---------------|

**PACKAGING STYLE AND QUANTITIES**

|                 |                   |
|-----------------|-------------------|
| Packaging style | Quantity          |
| Taping          | 15000 pieces/reel |

**RECOMMENDED SOLDERING CONDITION REFLOW SOLDERING**

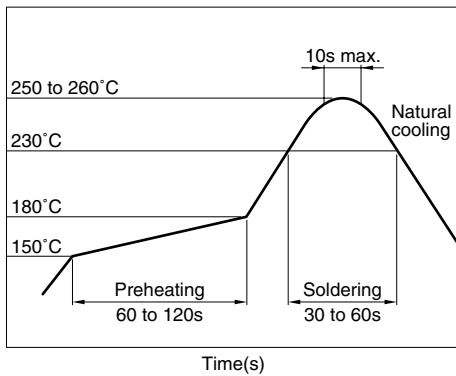

**TYPICAL ELECTRICAL CHARACTERISTICS Z FREQUENCY CHARACTERISTICS(DIFFERS ACCORDING TO SERIES)**

**MMZ0603S SERIES**

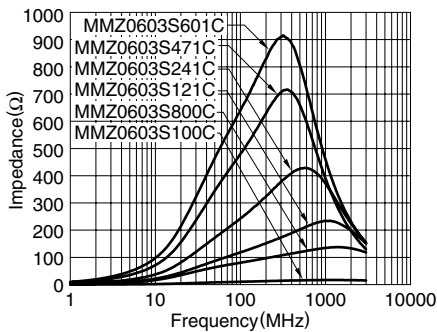

**MMZ0603Y SERIES**

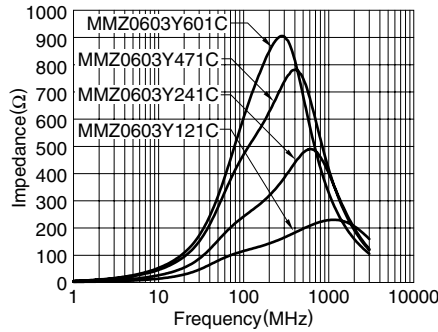

**MMZ0603D SERIES**

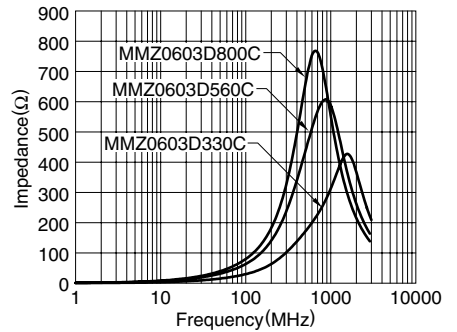

**MMZ0603F SERIES**

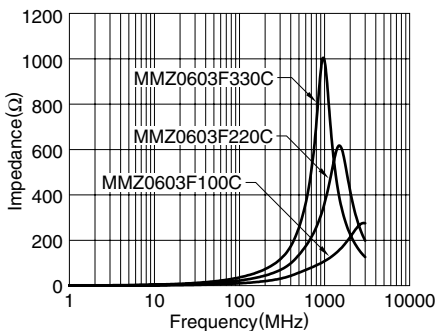

• All specifications are subject to change without notice.

**TYPICAL ELECTRICAL CHARACTERISTICS**

**Z, X, R vs. FREQUENCY CHARACTERISTICS**

**MMZ0603S100C**

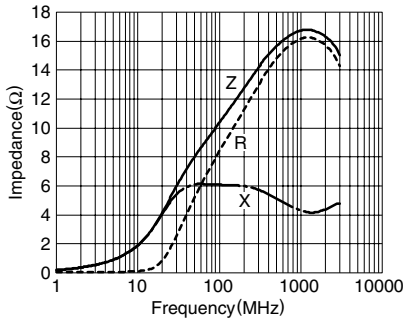

**MMZ0603S800C**

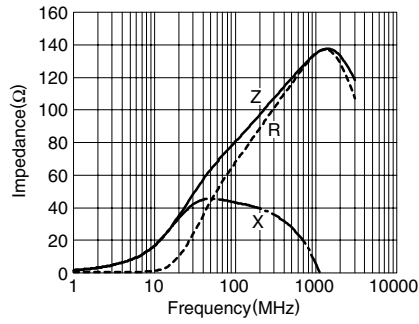

**MMZ0603S121C**

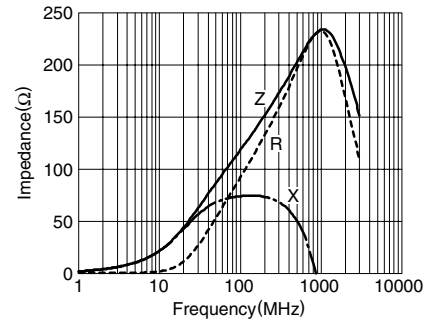

**MMZ0603S241C**

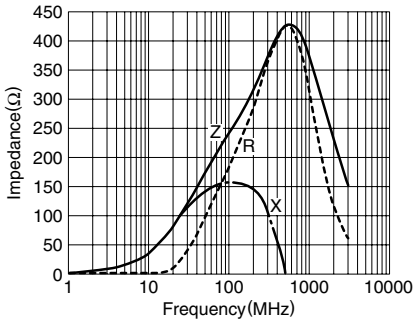

**MMZ0603S471C**

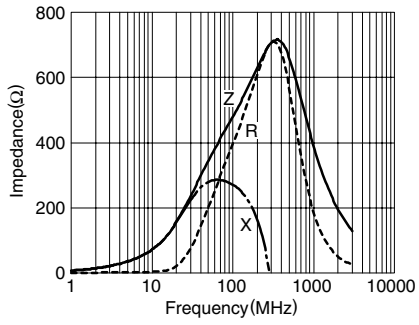

**MMZ0603S601C**

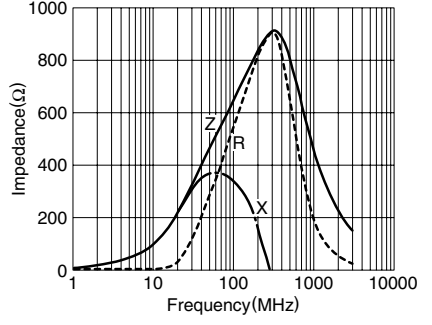

**MMZ0603Y121C**

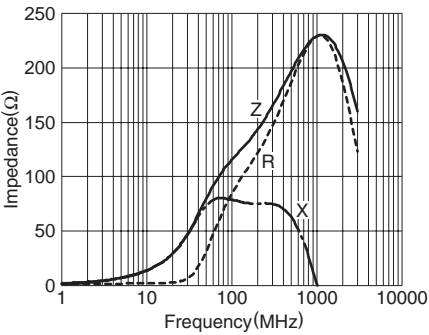

**MMZ0603Y241C**

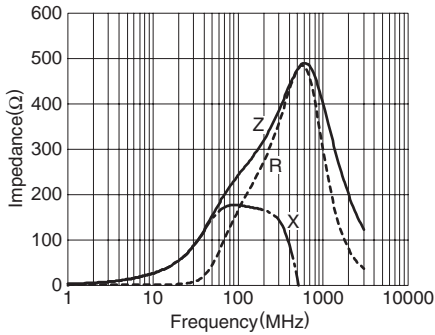

**MMZ0603Y471C**

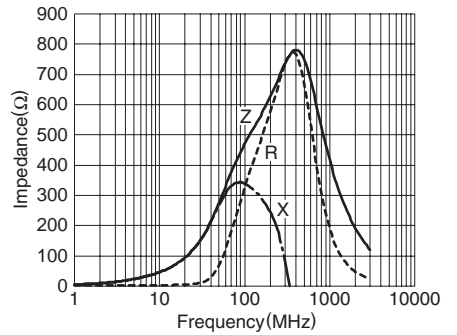

**MMZ0603Y601C**

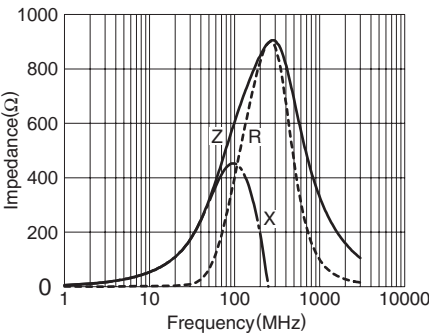

• All specifications are subject to change without notice.

**TYPICAL ELECTRICAL CHARACTERISTICS**  
**Z, X, R vs. FREQUENCY CHARACTERISTICS**  
**MMZ0603D330C**

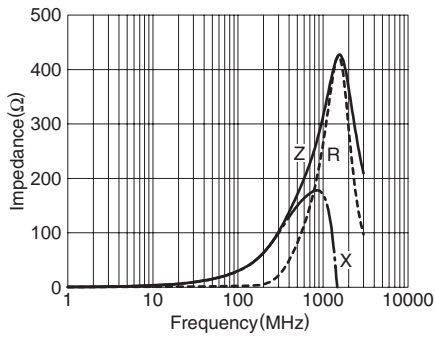

**MMZ0603D560C**

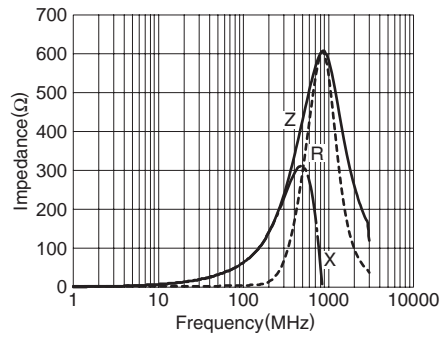

**MMZ0603D800C**

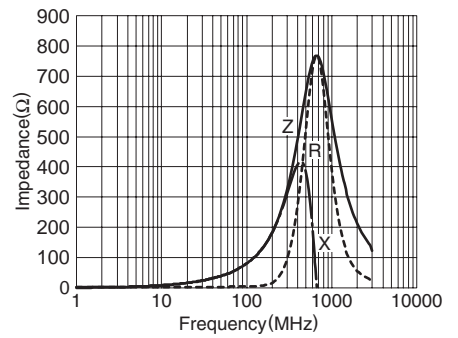

**MMZ0603F100C**

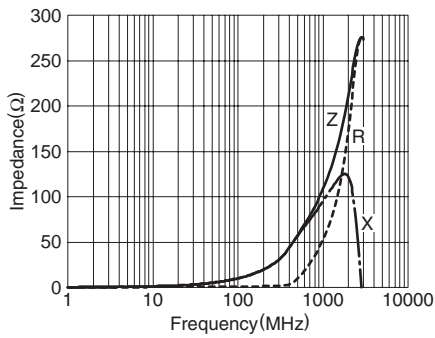

**MMZ0603F220C**

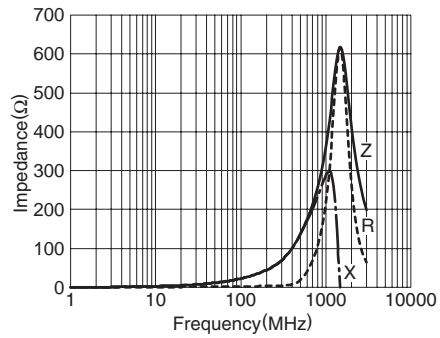

**MMZ0603F330C**

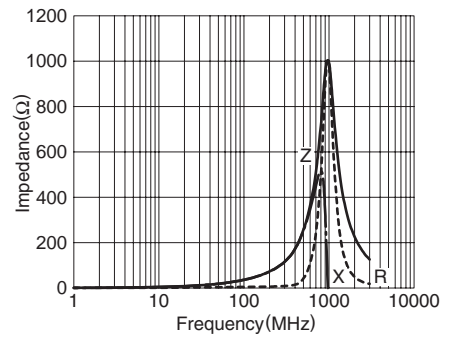

**PACKAGING STYLES**

**REEL DIMENSIONS**

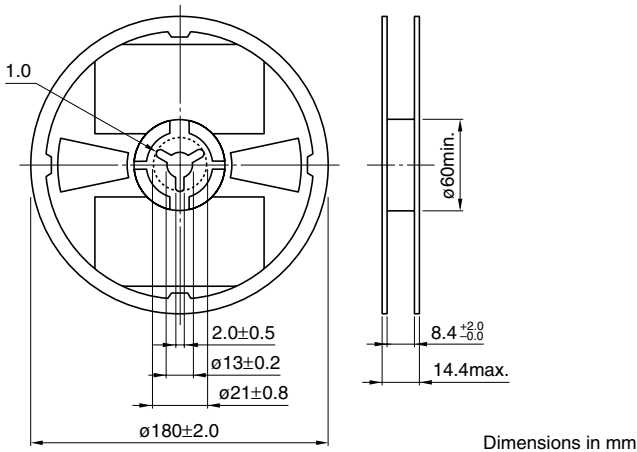

Dimensions in mm

**TAPE DIMENSIONS**

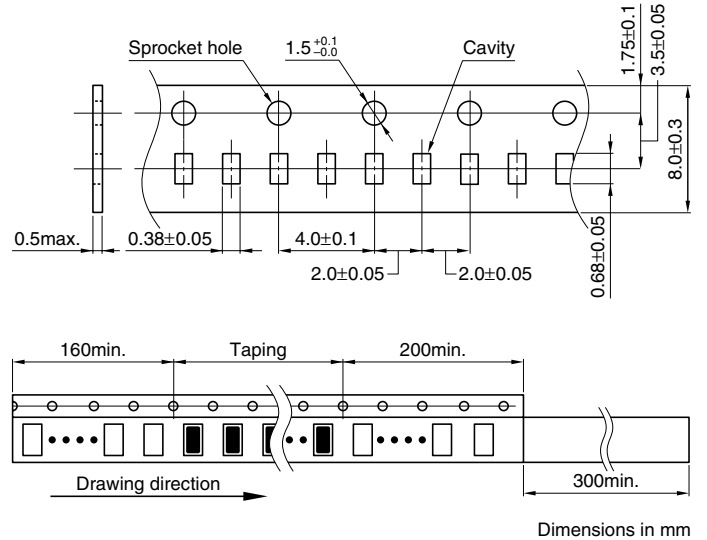

Dimensions in mm

• All specifications are subject to change without notice.

# Chip Beads For Signal Line

Conformity to RoHS Directive

## MMZ Series MMZ1005

### FEATURES

- Size standardized for use by automatic assembly equipment. No preferred orientation.
- Electroplated terminal electrodes accommodate reflow soldering.
- High reliability due to an entirely monolithic structure.
- Closed magnetic circuit structure allows high-density installation while preventing crosstalk between circuits.
- Low DC resistance structure of electrode prevents wasteful electric power consumption.
- It is a product conforming to RoHS directive.

### APPLICATIONS

Removal of signal line noises of cellular phones, PCs, note PCs, TVs, TV tuners, STBs, audio players, DVDs, DSCs, DVCs, game machines, digital photo frames, car navigation system, PNDs, etc.

### PRODUCT IDENTIFICATION

MMZ 1005 S 121 C T □□□  
(1) (2) (3) (4) (5) (6) (7)

- (1) Series name  
 (2) Dimensions L×W  
 (3) Type name  
 (4) Impedance  
 121:120Ω at 100MHz  
 (5) Characteristic type  
 (6) Packaging style  
 T:Taping  
 (7) TDK internal code

### HANDLING AND PRECAUTIONS

- Before soldering, be sure to preheat components. The preheating temperature should be set so that the temperature difference between the solder temperature and product temperature does not exceed 150°C.
- After mounting components onto the printed circuit board, do not apply stress through board bending or mishandling.
- Do not expose the inductors to stray magnetic fields.
- Avoid static electricity discharge during handling.
- When hand soldering, apply the soldering iron to the printed circuit board only. Temperature of the iron tip should not exceed 350°C. Soldering time should not exceed 3 seconds.

### MATERIAL CHARACTERISTICS

**B material:** This type is perfectly suited for fast digital signals. By equalizing R components and X components that beads possess at a frequency of 5MHz, it is able to suppress overshooting, undershooting and ringing of fast digital signals.

**S material:** Standard type that features impedance characteristics similar to those of a typical ferrite core. For signal line applications in which the blocking region is near 100MHz. Impedance values selected for effectiveness at 40 to 300MHz.

**Y material:** High frequency range type intended for the 100MHz region and above. For signal line applications in which the signal frequency is far from the cutoff frequency. Impedance values selected for effectiveness at 80 to 400MHz.

**D material:** For applications calling for low insertion loss at low frequencies and sharply increasing impedance at high frequencies. Designed for high impedance at high frequencies (300MHz to 1GHz) for signal line applications.

**F material:** This new product inherits the characteristic of our D-material, namely its sharp impedance rise time, and its impedance peak frequency has been shifted higher into range. The product offers excellent noise suppression from 600MHz to as high as in the GHz range.

### TYPICAL MATERIAL CHARACTERISTICS

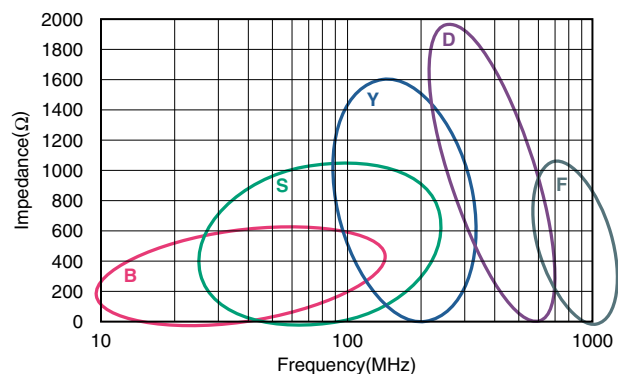

• Conformity to RoHS Directive: This means that, in conformity with EU Directive 2002/95/EC, lead, cadmium, mercury, hexavalent chromium, and specific bromine-based flame retardants, PBB and PBDE, have not been used, except for exempted applications.

• Please contact our Sales office when your application is considered the following:  
 The device's failure or malfunction may directly endanger human life (e.g. application for automobile/aircraft/medical/nuclear power devices, etc.)

• All specifications are subject to change without notice.



**SHAPES AND DIMENSIONS/RECOMMENDED PC BOARD**

**PATTERN**

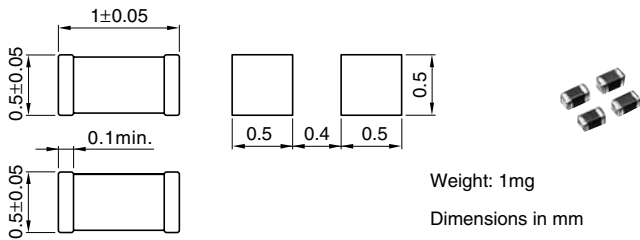

**TEMPERATURE RANGES**

|                   |               |
|-------------------|---------------|
| Operating/storage | -55 to +125°C |
|-------------------|---------------|

**PACKAGING STYLE AND QUANTITIES**

|                 |                   |
|-----------------|-------------------|
| Packaging style | Quantity          |
| Taping          | 10000 pieces/reel |

**RECOMMENDED SOLDERING CONDITION**

**REFLOW SOLDERING**

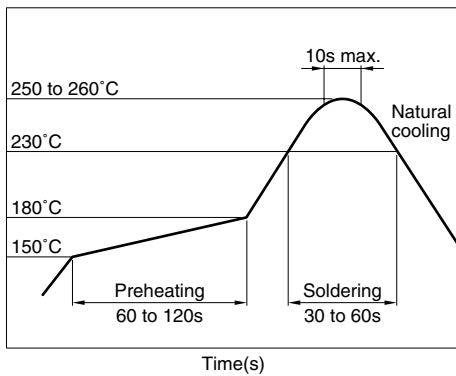

**ELECTRICAL CHARACTERISTICS**

| Part No.     | Impedance (Ω)[100MHz]* | DC resistance (Ω)max. | Rated current (mA)max. |
|--------------|------------------------|-----------------------|------------------------|
| MMZ1005B800C | 80±25%                 | 0.19                  | 450                    |
| MMZ1005B121C | 120±25%                | 0.25                  | 400                    |
| MMZ1005B601C | 600±25%                | 0.85                  | 200                    |
| MMZ1005S800C | 80±25%                 | 0.12                  | 500                    |
| MMZ1005S121C | 120±25%                | 0.22                  | 500                    |
| MMZ1005S241C | 240±25%                | 0.28                  | 400                    |
| MMZ1005S601C | 600±25%                | 0.52                  | 300                    |
| MMZ1005S102C | 1000±25%               | 0.75                  | 200                    |
| MMZ1005Y400C | 40±25%                 | 0.10                  | 550                    |
| MMZ1005Y800C | 80±25%                 | 0.17                  | 450                    |
| MMZ1005Y121C | 120±25%                | 0.18                  | 400                    |
| MMZ1005Y241C | 240±25%                | 0.26                  | 300                    |
| MMZ1005Y301C | 300±25%                | 0.38                  | 250                    |
| MMZ1005Y471C | 470±25%                | 0.47                  | 250                    |
| MMZ1005Y601C | 600±25%                | 0.54                  | 250                    |
| MMZ1005Y102C | 1000±25%               | 0.70                  | 200                    |
| MMZ1005Y152C | 1500±25%               | 1.00                  | 100                    |
| MMZ1005D100C | 10±5Ω                  | 0.10                  | 500                    |
| MMZ1005D220C | 22±25%                 | 0.17                  | 400                    |
| MMZ1005D330C | 33±25%                 | 0.24                  | 400                    |
| MMZ1005D680C | 68±25%                 | 0.38                  | 400                    |
| MMZ1005D121C | 120±25%                | 0.60                  | 350                    |
| MMZ1005D241C | 240±25%                | 0.90                  | 200                    |
| MMZ1005F330C | 33±25%                 | 0.50                  | 200                    |
| MMZ1005F470C | 47±25%                 | 0.60                  | 100                    |
| MMZ1005F560C | 56±25%                 | 0.70                  | 100                    |

\* Test equipment: E4991A or equivalent  
Test tool: 16192A or equivalent  
Test temperature: 25±10°C

**TYPICAL ELECTRICAL CHARACTERISTICS**

**Z FREQUENCY CHARACTERISTICS(DIFFERS ACCORDING TO SERIES)**

**MMZ1005B SERIES**

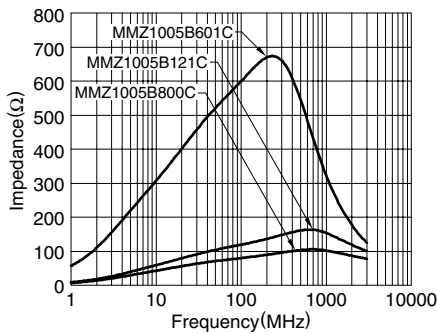

**MMZ1005S SERIES**

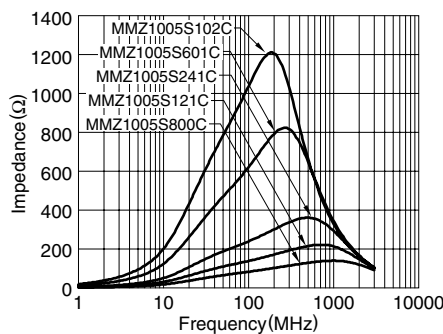

**MMZ1005Y SERIES**

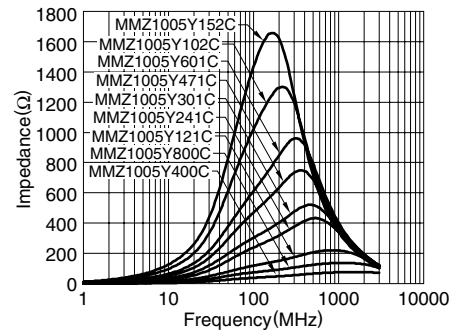

**MMZ1005D SERIES**

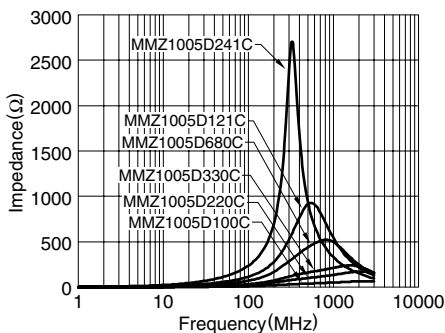

**MMZ1005F SERIES**

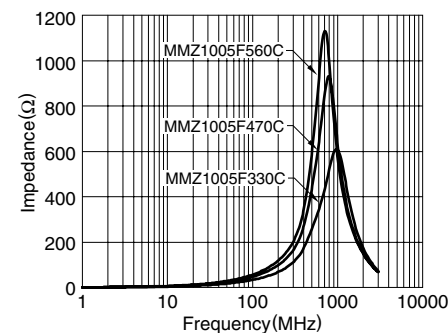

• All specifications are subject to change without notice.

**TYPICAL ELECTRICAL CHARACTERISTICS**

**Z, X, R vs. FREQUENCY CHARACTERISTICS**

**MMZ1005B800C**

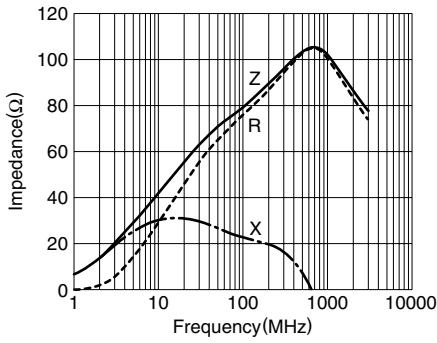

**MMZ1005B121C**

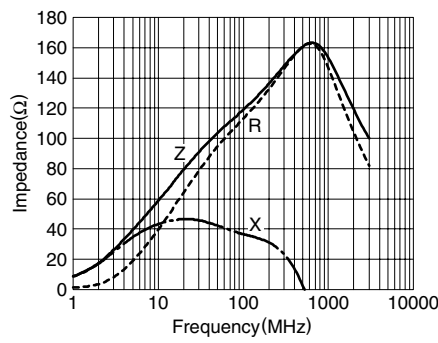

**MMZ1005B601C**

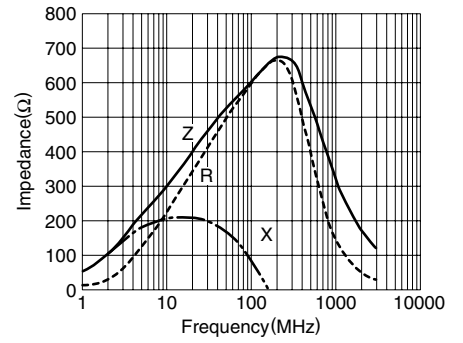

**MMZ1005S800C**

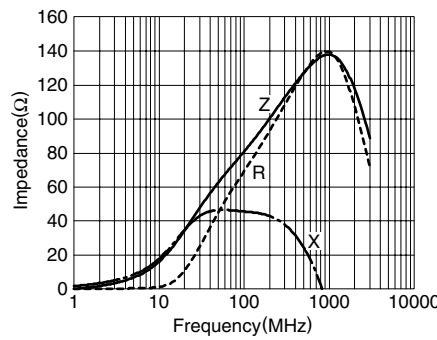

**MMZ1005S121C**

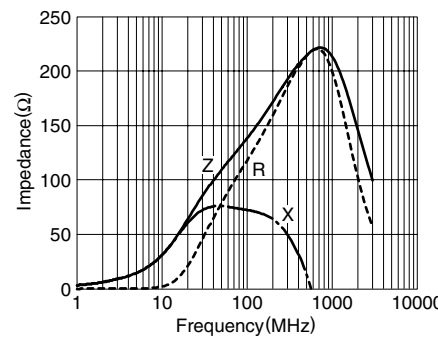

**MMZ1005S241C**

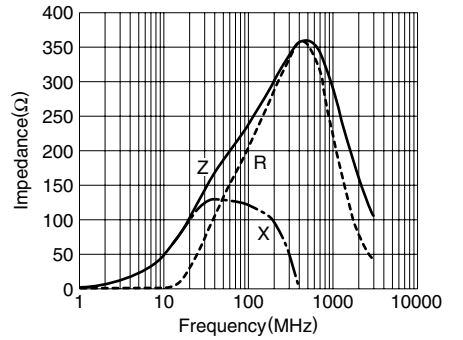

**MMZ1005S601C**

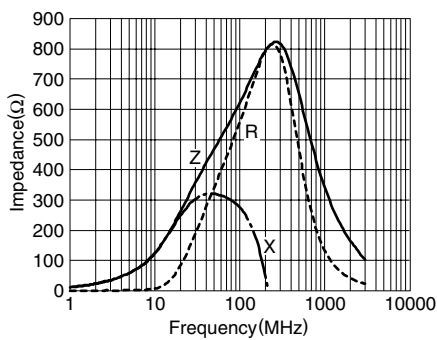

**MMZ1005S102C**

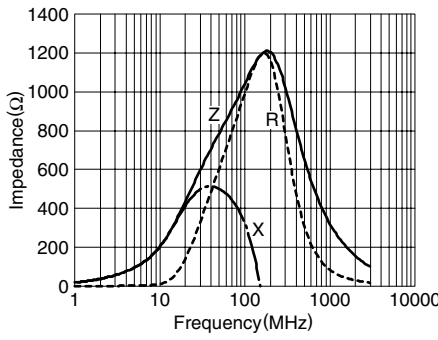

**MMZ1005Y400C**

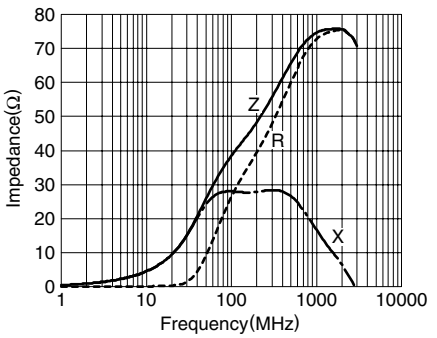

**MMZ1005Y800C**

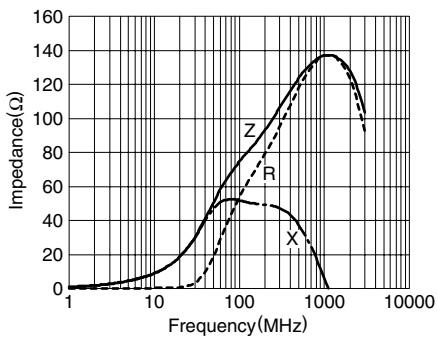

**MMZ1005Y121C**

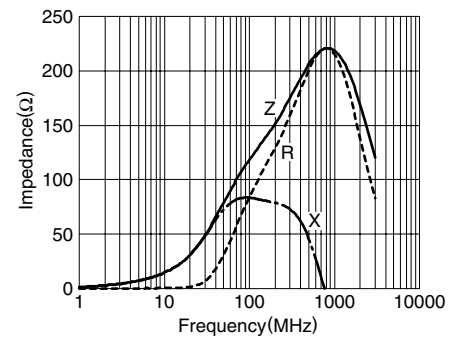

• All specifications are subject to change without notice.

**TYPICAL ELECTRICAL CHARACTERISTICS**  
**Z, X, R vs. FREQUENCY CHARACTERISTICS**  
**MMZ1005Y241C**

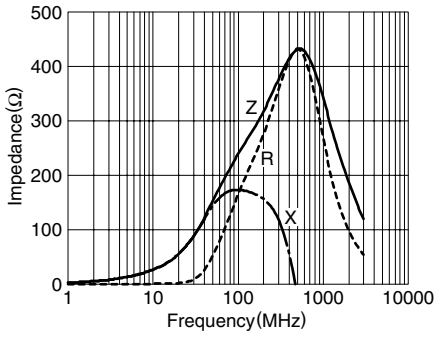

**MMZ1005Y301C**

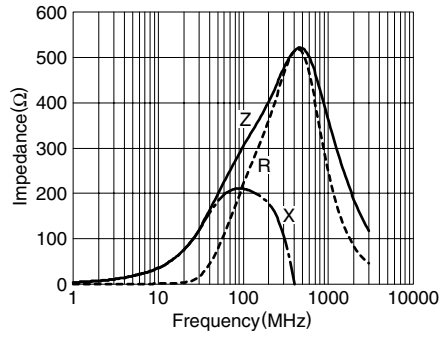

**MMZ1005Y471C**

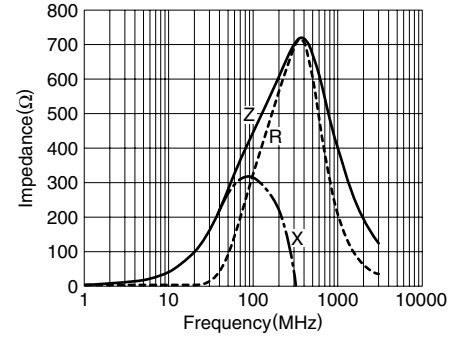

**MMZ1005Y601C**

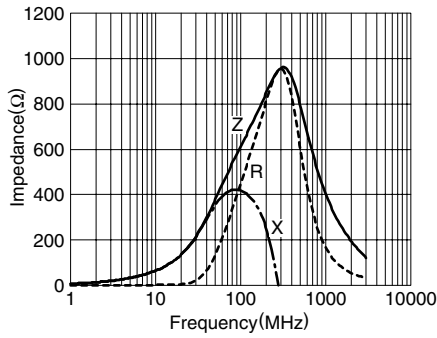

**MMZ1005Y102C**

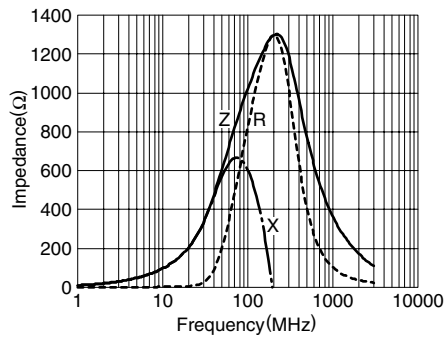

**MMZ1005Y152C**

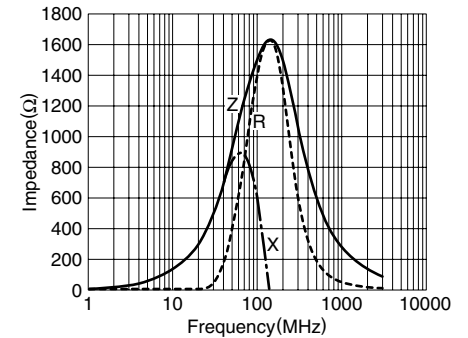

**MMZ1005D100C**

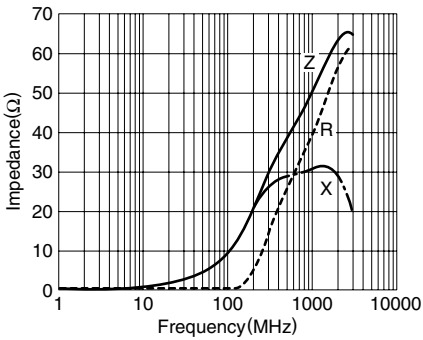

**MMZ1005D220C**

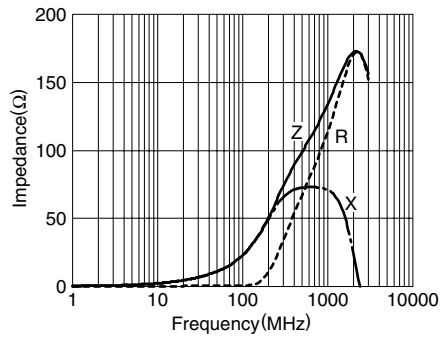

**MMZ1005D330C**

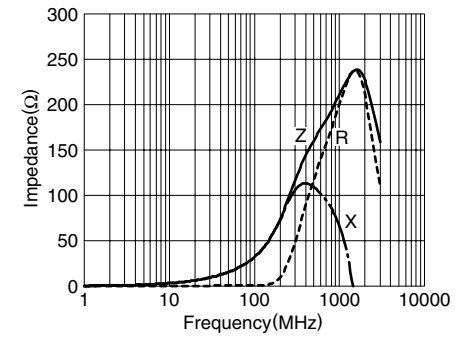

**MMZ1005D680C**

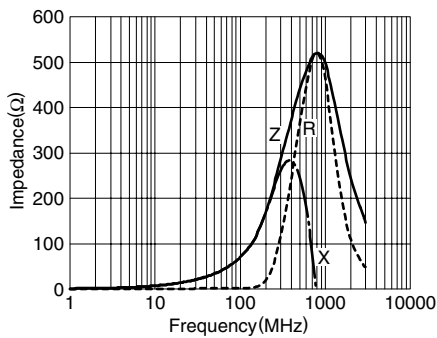

**MMZ1005D121C**

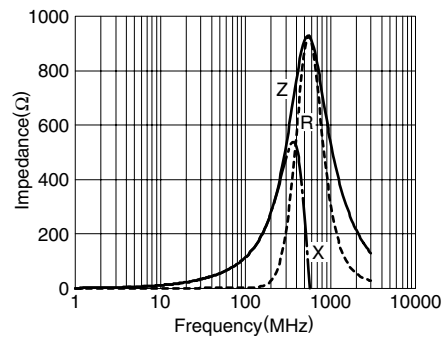

**MMZ1005D241C**

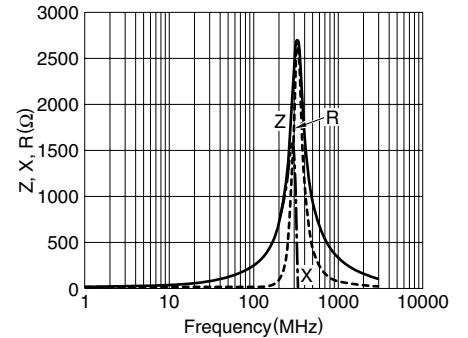

• All specifications are subject to change without notice.

**TYPICAL ELECTRICAL CHARACTERISTICS**  
**Z, X, R vs. FREQUENCY CHARACTERISTICS**  
**MMZ1005F330C**

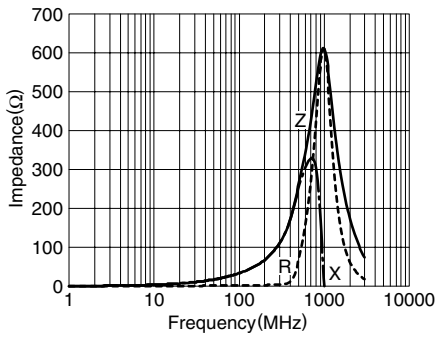

**MMZ1005F470C**

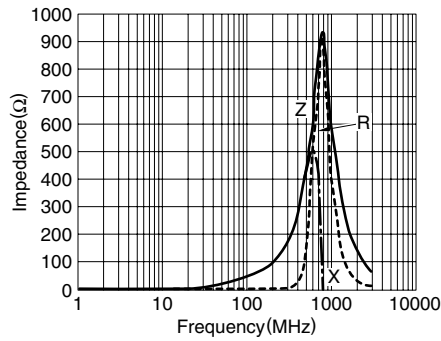

**MMZ1005F560C**

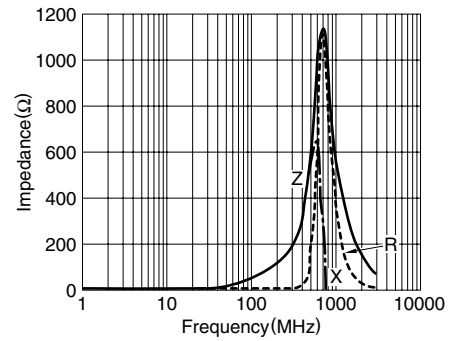

**PACKAGING STYLES**  
**REEL DIMENSIONS**

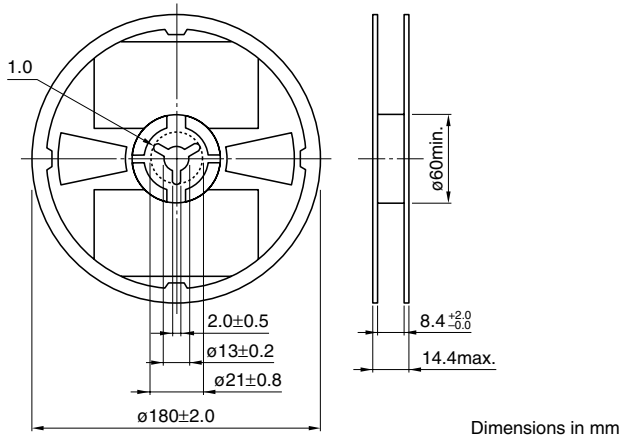

Dimensions in mm

**TAPE DIMENSIONS**

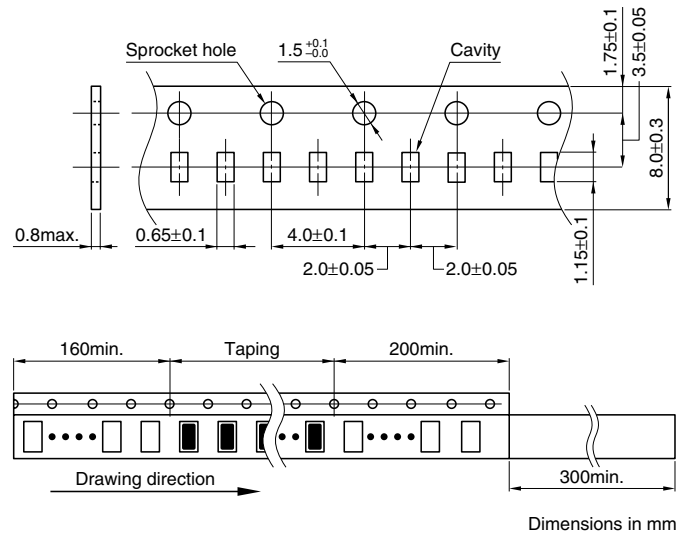

Dimensions in mm

• All specifications are subject to change without notice.

# Chip Beads For Signal Line

Conformity to RoHS Directive

## MMZ Series MMZ1608

### FEATURES

- Chip bead(impeder), MMZ series offers 8 construction materials.
- Size standardized for use by automatic assembly equipment.  
No preferred orientation.
- Either flow or reflow soldering methods can be used due to electroplating of the terminal electrodes.
- High reliability due to an entirely monolithic structure.
- Closed magnetic circuit structure allows high-density installation while preventing crosstalk between circuits.
- Low DC resistance structure of electrode prevents wasteful electric power consumption.
- The products contain no lead and also support lead-free soldering.
- It is a product conforming to RoHS directive.

### APPLICATIONS

Removal of signal line noises of cellular phones, PCs, note PCs, TVs, TV tuners, STBs, audio players, DVDs, DSCs, DVCs, game machines, digital photo frames, car navigation system, PNDs, etc.

### PRODUCT IDENTIFICATION

MMZ 1608 R 121 A T   
 (1) (2) (3) (4) (5) (6) (7)

- (1) Series name
- (2) Dimensions L×W
- (3) Type name
- (4) Impedance  
121:120Ω at 100MHz
- (5) Characteristic type
- (6) Packaging style  
T:Taping
- (7) TDK internal code

### HANDLING AND PRECAUTIONS

- Before soldering, be sure to preheat components. The preheating temperature should be set so that the temperature difference between the solder temperature and product temperature does not exceed 150°C.
- After mounting components onto the printed circuit board, do not apply stress through board bending or mishandling.
- Do not expose the inductors to stray magnetic fields.
- Avoid static electricity discharge during handling.
- When hand soldering, apply the soldering iron to the printed circuit board only. Temperature of the iron tip should not exceed 350°C. Soldering time should not exceed 3 seconds.

• Conformity to RoHS Directive: This means that, in conformity with EU Directive 2002/95/EC, lead, cadmium, mercury, hexavalent chromium, and specific bromine-based flame retardants, PBB and PBDE, have not been used, except for exempted applications.

• Please contact our Sales office when your application is considered the following:  
The device's failure or malfunction may directly endanger human life (e.g. application for automobile/aircraft/medical/nuclear power devices, etc.)

• All specifications are subject to change without notice.

### SHAPES AND DIMENSIONS/RECOMMENDED PC BOARD PATTERN

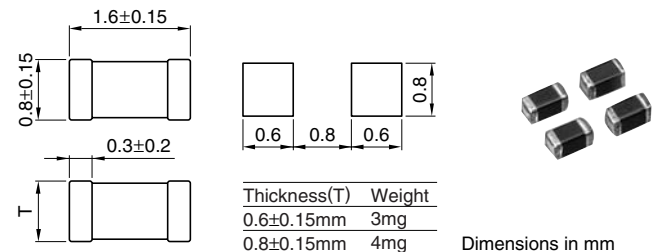

### TEMPERATURE RANGES

|                   |               |
|-------------------|---------------|
| Operating/storage | -55 to +125°C |
|-------------------|---------------|

### PACKAGING STYLE AND QUANTITIES

|                 |                  |
|-----------------|------------------|
| Packaging style | Quantity         |
| Taping          | 4000 pieces/reel |

### RECOMMENDED SOLDERING CONDITION REFLOW SOLDERING

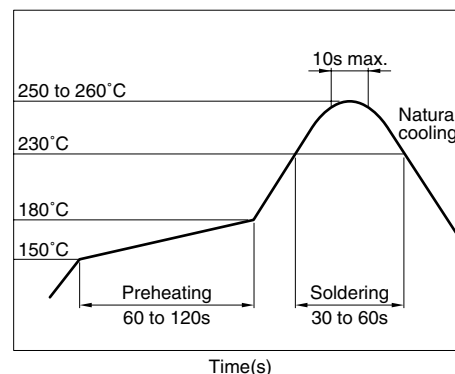

## MATERIAL CHARACTERISTICS

**B material:** This type is perfectly suited for fast digital signals.

By equalizing R components and X components that beads possess at a frequency of 5MHz, it is able to suppress overshooting, undershooting and ringing of fast digital signals.

**R material:** For wide frequency applications calling for broad impedance characteristics.

For digital signal line applications calling requiring good waveform integrity. Impedance values selected for effectiveness at 10 to 200MHz.

**S material:** Standard type that features impedance characteristics similar to those of a typical ferrite core.

For signal line applications in which the blocking region is near 100MHz. Impedance values selected for effectiveness at 40 to 300MHz.

**Y material:** High frequency range type intended for the 100MHz region and above.

For signal line applications in which the signal frequency is far from the cutoff frequency. Impedance values selected for effectiveness at 80 to 400MHz.

**A material:** This high-impedance product is based on the impedance frequency characteristics of our Y-material. The product offers excellent impedance characteristics, which is greater than  $2500\Omega$  in the vicinity of 100MHz range (MMZ1608A252B).

**Q material:** For high-band applications designed for 100MHz and above. Impedance values selected for effectiveness at 100 to 800MHz.

**D material:** For applications calling for low insertion loss at low frequencies and sharply increasing impedance at high frequencies. Designed for high impedance at high frequencies (300MHz to 1GHz) for signal line applications.

**F material:** This new product inherits the characteristic of our D-material, namely its sharp impedance rise time, and its impedance peak frequency has been shifted higher into range.

The product offers excellent noise suppression from 600MHz to as high as in the GHz range.

## TYPICAL MATERIAL CHARACTERISTICS

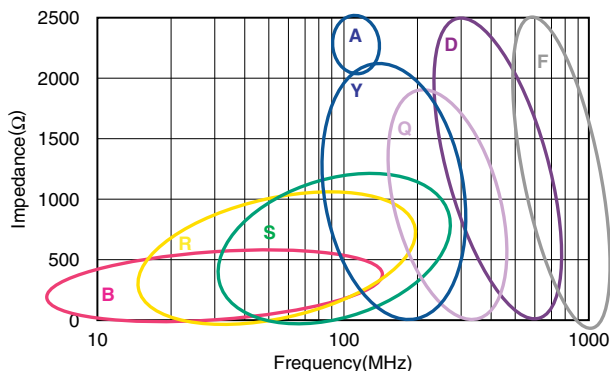

## ELECTRICAL CHARACTERISTICS

| Part No.     | Impedance ( $\Omega$ ) [100MHz]* | DC resistance ( $\Omega$ )max. | Rated current (mA)max. | Product's thickness T(mm) |
|--------------|----------------------------------|--------------------------------|------------------------|---------------------------|
| MMZ1608B121C | 120±25%                          | 0.15                           | 600                    | 0.6                       |
| MMZ1608B221C | 220±25%                          | 0.25                           | 500                    | 0.6                       |
| MMZ1608B301C | 300±25%                          | 0.25                           | 500                    | 0.6                       |
| MMZ1608B471C | 470±25%                          | 0.30                           | 500                    | 0.6                       |
| MMZ1608B601C | 600±25%                          | 0.40                           | 500                    | 0.6                       |
| MMZ1608B102C | 1000±25%                         | 0.60                           | 300                    | 0.8                       |
| MMZ1608R150A | 15±25%                           | 0.05                           | 1500                   | 0.8                       |
| MMZ1608R300A | 30±25%                           | 0.05                           | 1500                   | 0.8                       |
| MMZ1608R600A | 60±25%                           | 0.10                           | 800                    | 0.8                       |
| MMZ1608R121A | 120±25%                          | 0.18                           | 500                    | 0.8                       |
| MMZ1608R301A | 300±25%                          | 0.25                           | 500                    | 0.8                       |
| MMZ1608R471A | 470±25%                          | 0.30                           | 500                    | 0.8                       |
| MMZ1608R601A | 600±25%                          | 0.40                           | 500                    | 0.8                       |
| MMZ1608R102A | 1000±25%                         | 0.50                           | 400                    | 0.8                       |
| MMZ1608S400A | 40±25%                           | 0.10                           | 600                    | 0.8                       |
| MMZ1608S800A | 80±25%                           | 0.15                           | 500                    | 0.8                       |
| MMZ1608S121A | 120±25%                          | 0.15                           | 500                    | 0.8                       |
| MMZ1608S181A | 180±25%                          | 0.20                           | 500                    | 0.8                       |
| MMZ1608S221A | 220±25%                          | 0.20                           | 500                    | 0.8                       |
| MMZ1608S301A | 300±25%                          | 0.30                           | 500                    | 0.8                       |
| MMZ1608S471A | 470±25%                          | 0.30                           | 500                    | 0.8                       |
| MMZ1608S601A | 600±25%                          | 0.35                           | 500                    | 0.8                       |
| MMZ1608S102A | 1000±25%                         | 0.50                           | 400                    | 0.8                       |
| MMZ1608S202A | 2000±25%                         | 0.90                           | 200                    | 0.8                       |
| MMZ1608Y150B | 15±25%                           | 0.05                           | 1500                   | 0.8                       |
| MMZ1608Y300B | 30±25%                           | 0.05                           | 1500                   | 0.8                       |
| MMZ1608Y600B | 60±25%                           | 0.15                           | 500                    | 0.8                       |
| MMZ1608Y121B | 120±25%                          | 0.20                           | 500                    | 0.8                       |
| MMZ1608Y221B | 220±25%                          | 0.30                           | 500                    | 0.8                       |
| MMZ1608Y301B | 300±25%                          | 0.30                           | 500                    | 0.8                       |
| MMZ1608Y471B | 470±25%                          | 0.35                           | 500                    | 0.8                       |
| MMZ1608Y601B | 600±25%                          | 0.40                           | 500                    | 0.8                       |
| MMZ1608Y751B | 750±25%                          | 0.45                           | 500                    | 0.8                       |
| MMZ1608Y102B | 1000±25%                         | 0.50                           | 400                    | 0.8                       |
| MMZ1608Y152B | 1500±25%                         | 0.60                           | 300                    | 0.8                       |
| MMZ1608A182B | 1800±25%                         | 0.80                           | 200                    | 0.8                       |
| MMZ1608A222B | 2200±25%                         | 0.80                           | 200                    | 0.8                       |
| MMZ1608A252B | 2500±25%                         | 0.80                           | 200                    | 0.8                       |
| MMZ1608Q121B | 120±25%                          | 0.30                           | 500                    | 0.8                       |
| MMZ1608Q221B | 220±25%                          | 0.40                           | 500                    | 0.8                       |
| MMZ1608Q331B | 330±25%                          | 0.50                           | 400                    | 0.8                       |
| MMZ1608Q471B | 470±25%                          | 0.70                           | 300                    | 0.8                       |
| MMZ1608Q601B | 600±25%                          | 0.80                           | 200                    | 0.8                       |
| MMZ1608Q102B | 1000±25%                         | 1.00                           | 200                    | 0.8                       |
| MMZ1608D050C | 5±2 $\Omega$                     | 0.05                           | 700                    | 0.8                       |
| MMZ1608D100C | 10±5 $\Omega$                    | 0.10                           | 500                    | 0.6                       |
| MMZ1608D220C | 22±25%                           | 0.20                           | 500                    | 0.6                       |
| MMZ1608D500C | 50±25%                           | 0.25                           | 500                    | 0.6                       |
| MMZ1608D800C | 80±25%                           | 0.30                           | 500                    | 0.6                       |
| MMZ1608D800B | 80±25%                           | 0.30                           | 500                    | 0.8                       |
| MMZ1608D121C | 120±25%                          | 0.30                           | 400                    | 0.6                       |
| MMZ1608D121B | 120±25%                          | 0.30                           | 400                    | 0.8                       |
| MMZ1608D241C | 240±25%                          | 0.60                           | 300                    | 0.8                       |
| MMZ1608D301B | 300±25%                          | 0.70                           | 300                    | 0.8                       |
| MMZ1608F030B | 3typ.                            | 0.05                           | 700                    | 0.8                       |
| MMZ1608F470B | 47±25%                           | 0.40                           | 500                    | 0.8                       |
| MMZ1608F750B | 75±25%                           | 0.55                           | 300                    | 0.8                       |
| MMZ1608F121B | 120±25%                          | 0.75                           | 200                    | 0.8                       |

\* Test equipment: E4991A or equivalent

Test tool: 16192A or equivalent

Test temperature: 25±10°C

### TYPICAL ELECTRICAL CHARACTERISTICS

#### Z, X, R vs. FREQUENCY CHARACTERISTICS

**MMZ1608B121C**

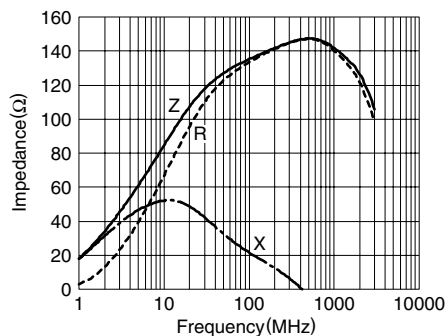

**MMZ1608B221C**

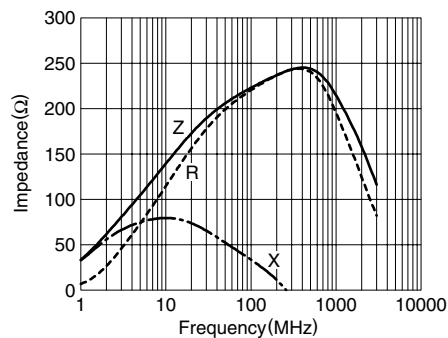

**MMZ1608B301C**

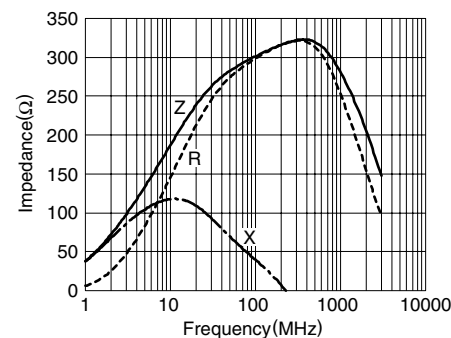

**MMZ1608B471C**

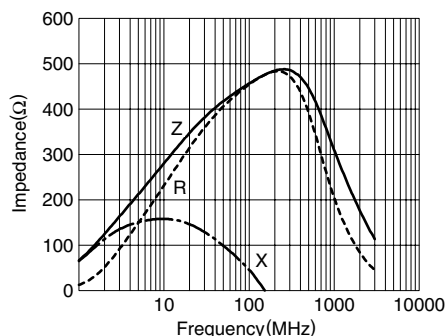

**MMZ1608B601C**

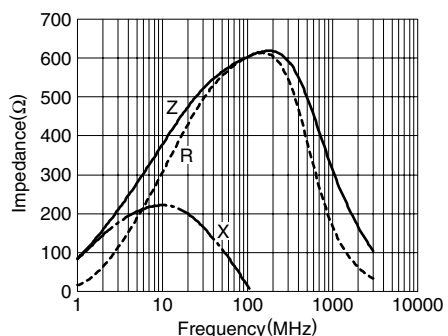

**MMZ1608B102C**

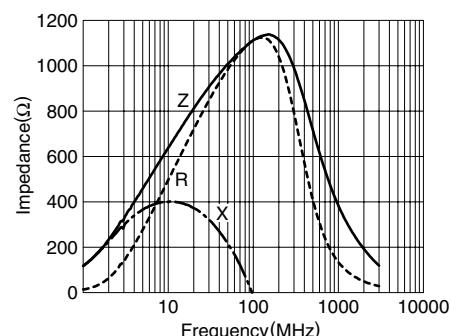

**MMZ1608R150A**

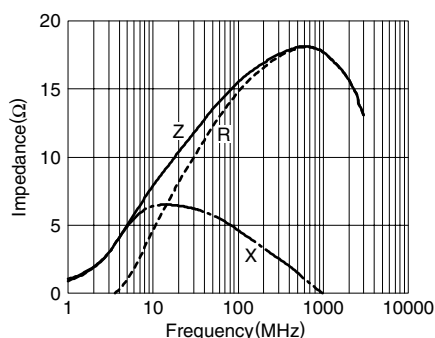

**MMZ1608R300A**

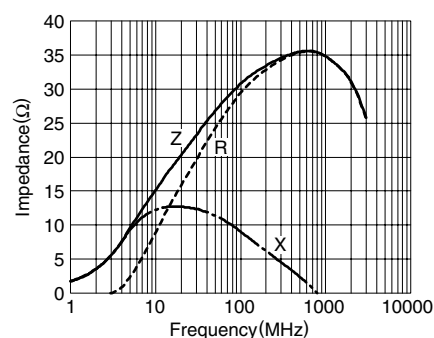

**MMZ1608R600A**

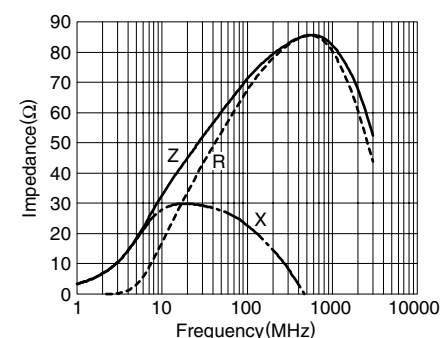

**MMZ1608R121A**

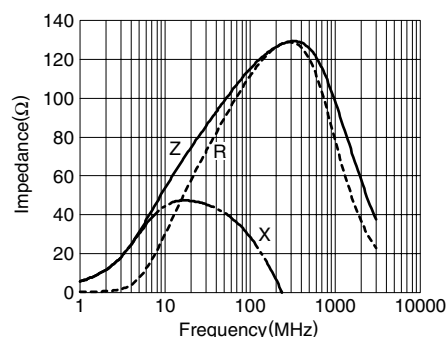

**MMZ1608R301A**

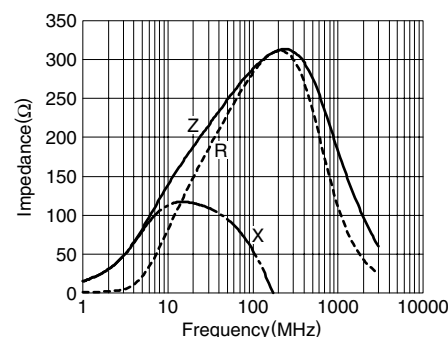

**MMZ1608R471A**

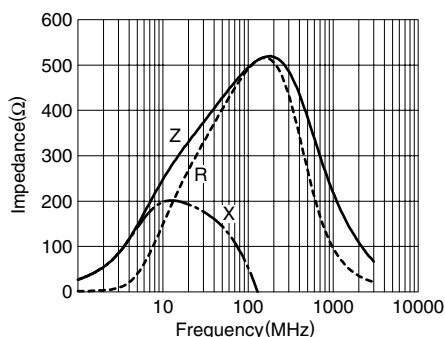

• All specifications are subject to change without notice.

**TYPICAL ELECTRICAL CHARACTERISTICS**  
**Z, X, R vs. FREQUENCY CHARACTERISTICS**  
**MMZ1608R601A**

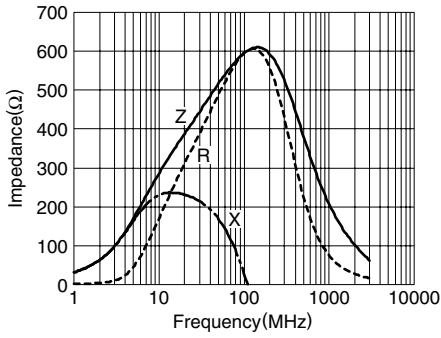

**MMZ1608R102A**

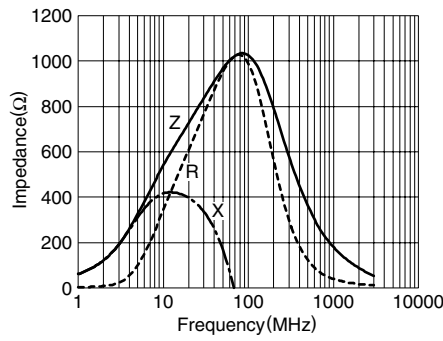

**MMZ1608S400A**

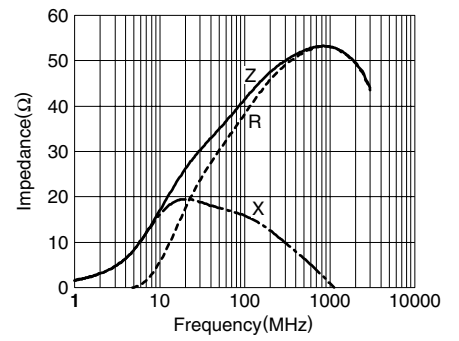

**MMZ1608S800A**

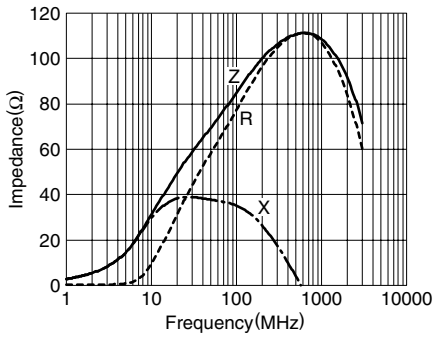

**MMZ1608S121A**

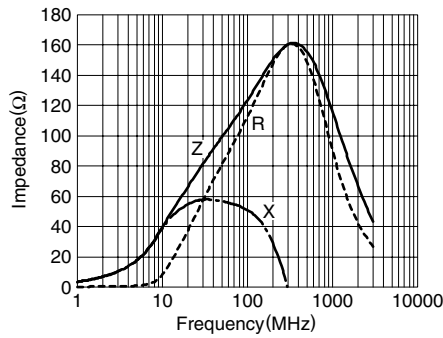

**MMZ1608S181A**

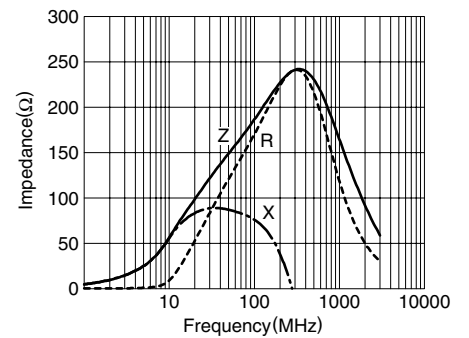

**MMZ1608S221A**

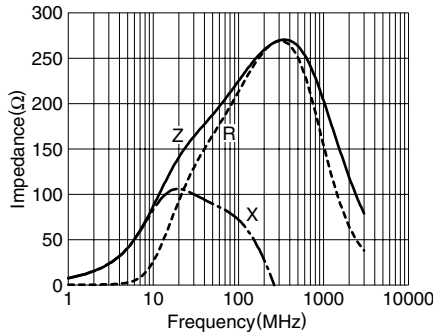

**MMZ1608S301A**

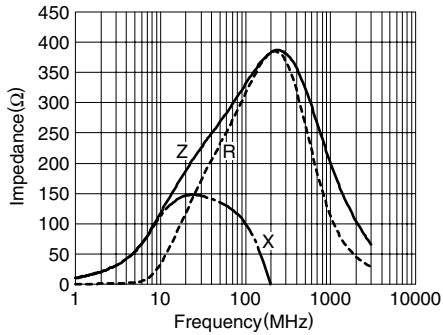

**MMZ1608S471A**

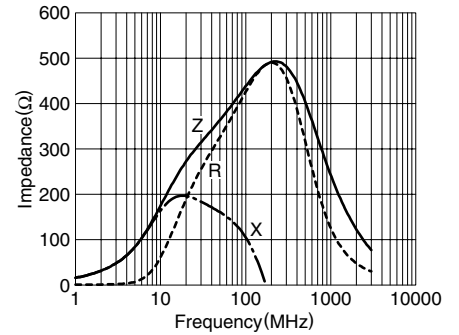

**MMZ1608S601A**

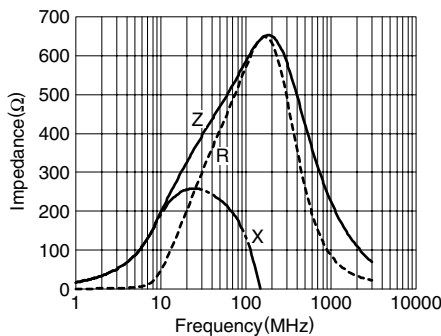

**MMZ1608S102A**

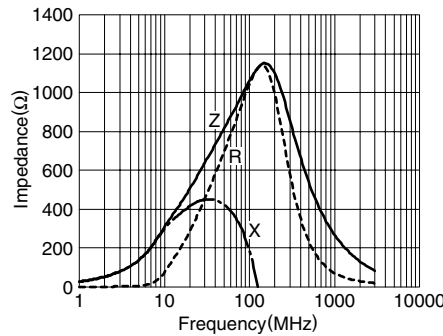

**MMZ1608S202A**

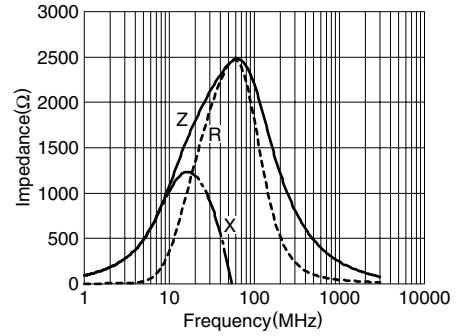

• All specifications are subject to change without notice.



### TYPICAL ELECTRICAL CHARACTERISTICS

#### Z, X, R vs. FREQUENCY CHARACTERISTICS

**MMZ1608Y150B**

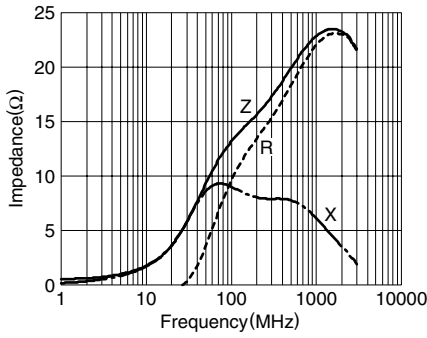

**MMZ1608Y300B**

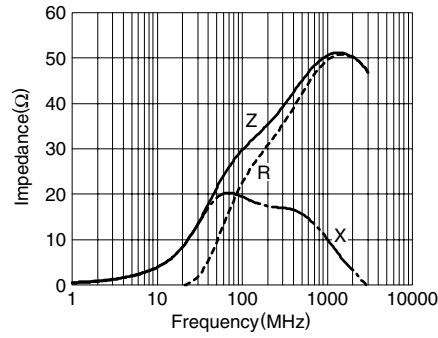

**MMZ1608Y600B**

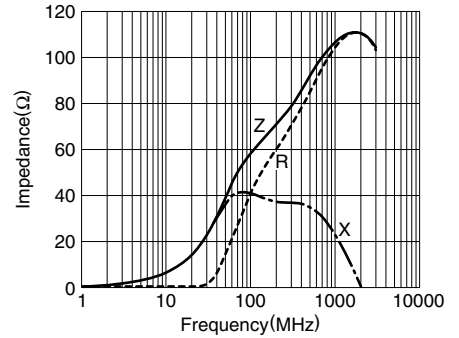

**MMZ1608Y121B**

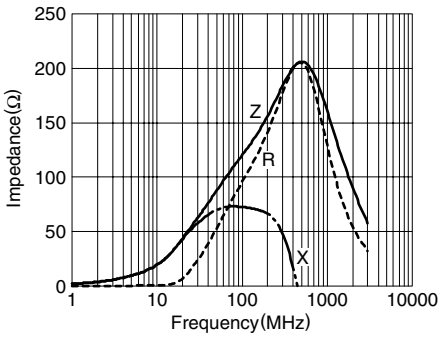

**MMZ1608Y221B**

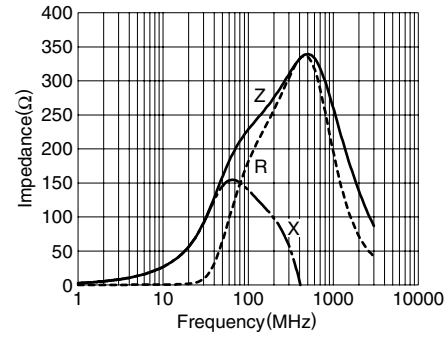

**MMZ1608Y301B**

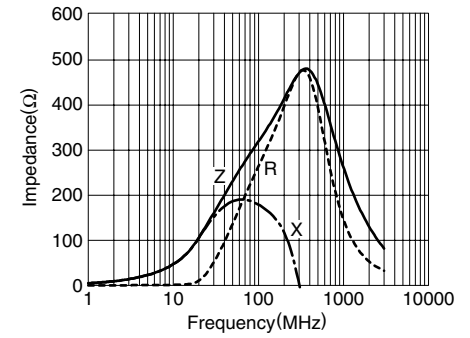

**MMZ1608Y471B**

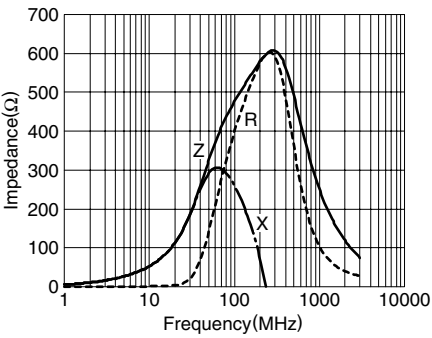

**MMZ1608Y601B**

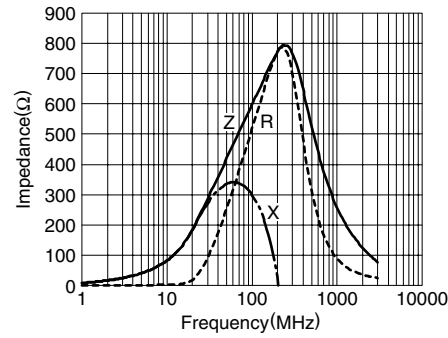

**MMZ1608Y751B**

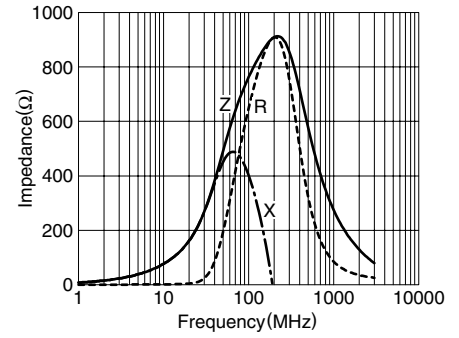

**MMZ1608Y102B**

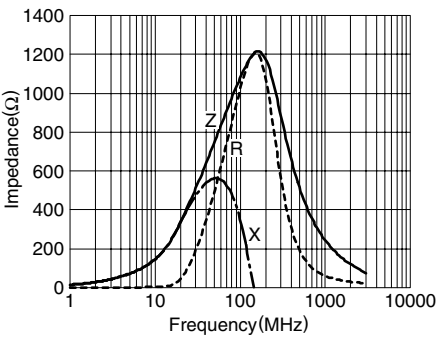

**MMZ1608Y152B**

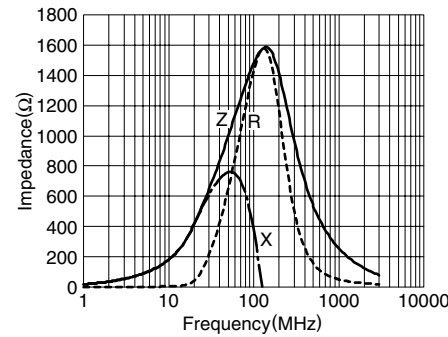

• All specifications are subject to change without notice.

**TYPICAL ELECTRICAL CHARACTERISTICS**

**Z, X, R vs. FREQUENCY CHARACTERISTICS**

**MMZ1608A182B**

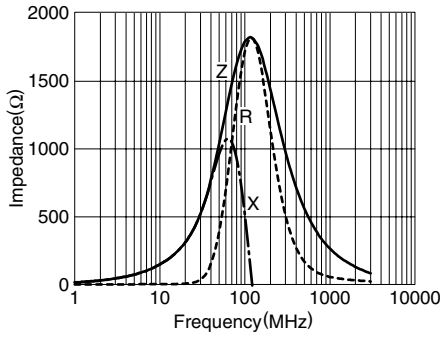

**MMZ1608A222B**

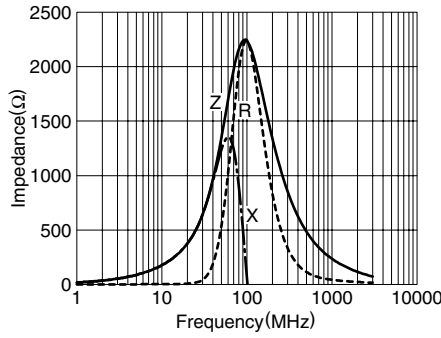

**MMZ1608A252B**

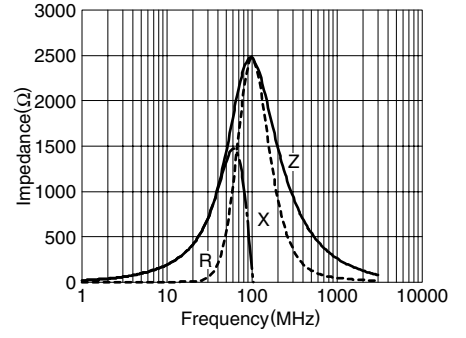

**MMZ1608Q121B**

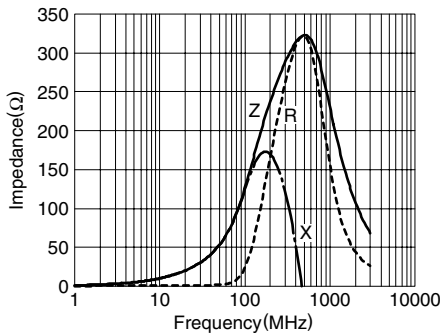

**MMZ1608Q221B**

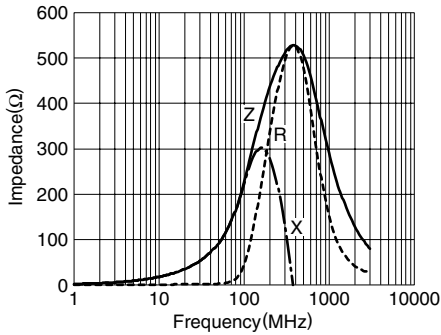

**MMZ1608Q331B**

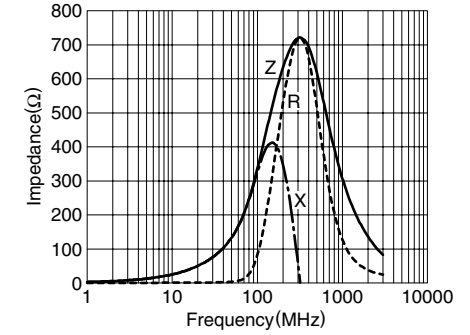

**MMZ1608Q471B**

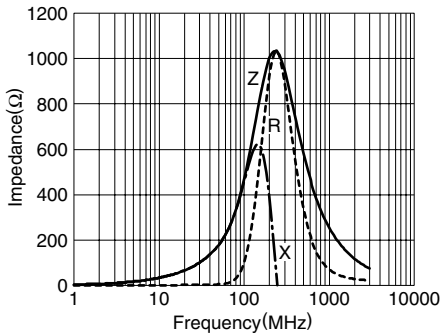

**MMZ1608Q601B**

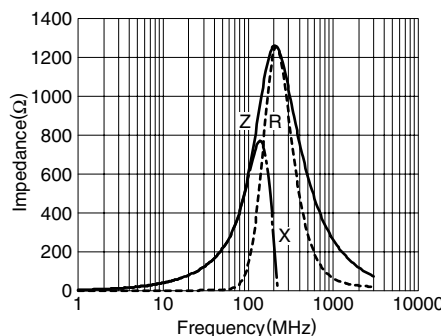

**MMZ1608Q102B**

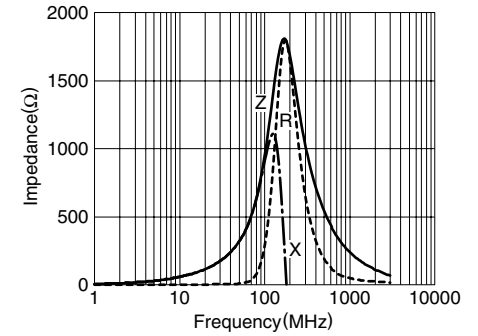

**MMZ1608D050C**

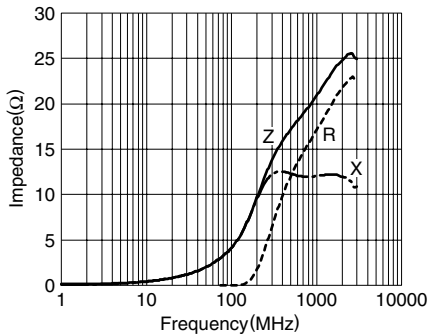

**MMZ1608D100C**

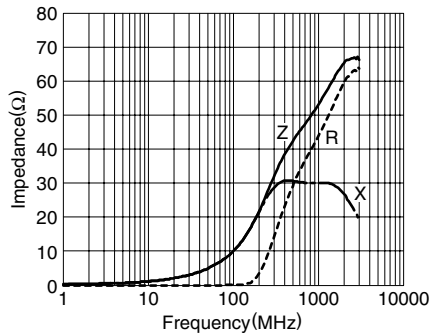

**MMZ1608D220C**

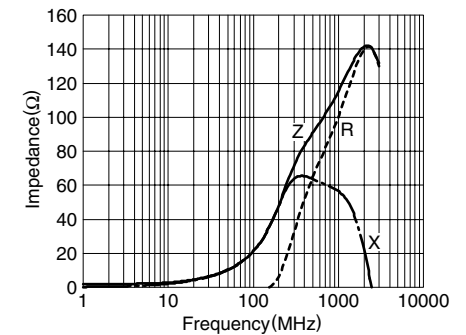

• All specifications are subject to change without notice.

### TYPICAL ELECTRICAL CHARACTERISTICS

#### Z, X, R vs. FREQUENCY CHARACTERISTICS

**MMZ1608D500C**

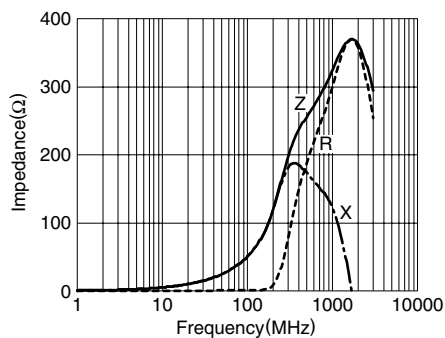

**MMZ1608D800C**

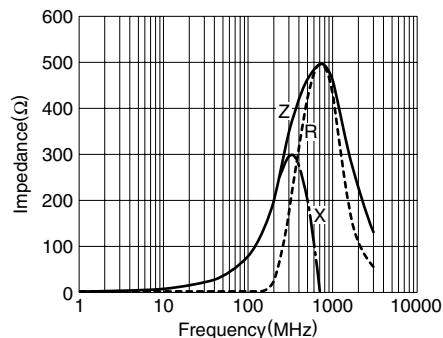

**MMZ1608D800B**

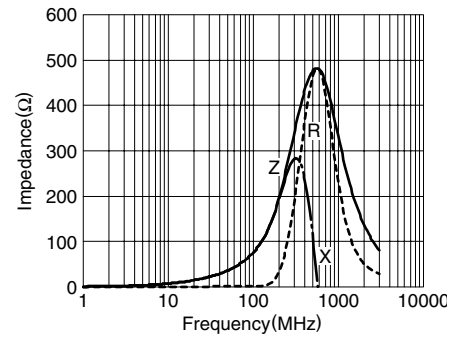

**MMZ1608D121C**

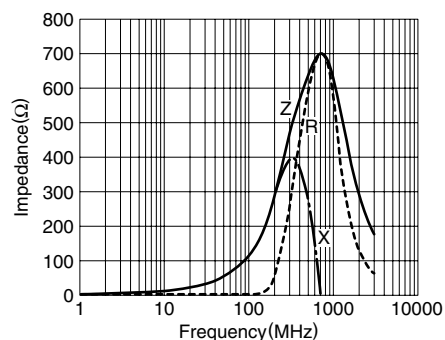

**MMZ1608D121B**

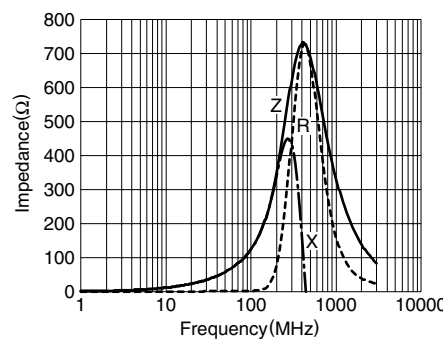

**MMZ1608D241C**

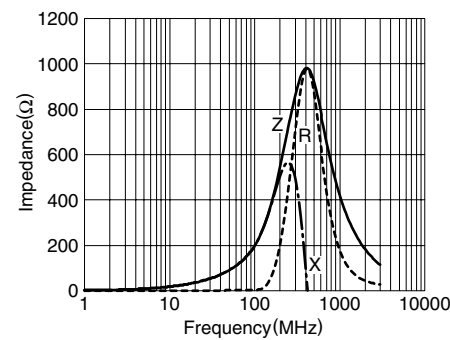

**MMZ1608D301B**

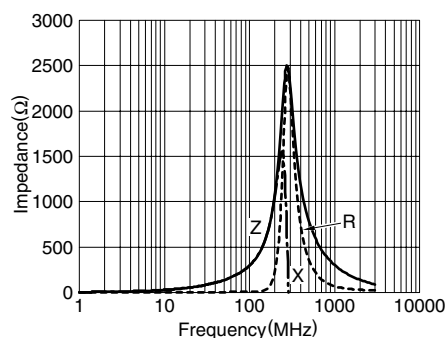

**MMZ1608F030B**

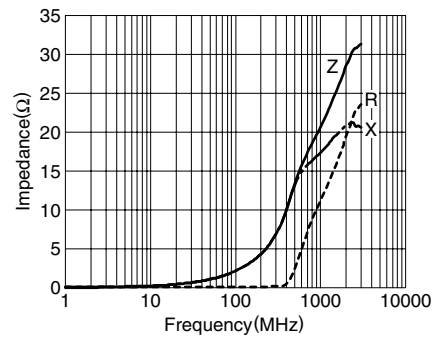

**MMZ1608F470B**

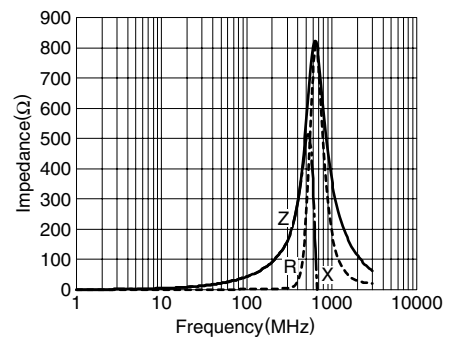

**MMZ1608F750B**

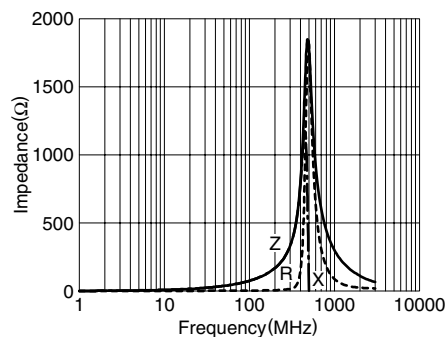

**MMZ1608F121B**

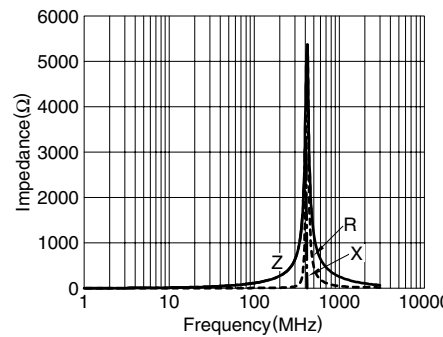

• All specifications are subject to change without notice.

**PACKAGING STYLES**  
**REEL DIMENSIONS**

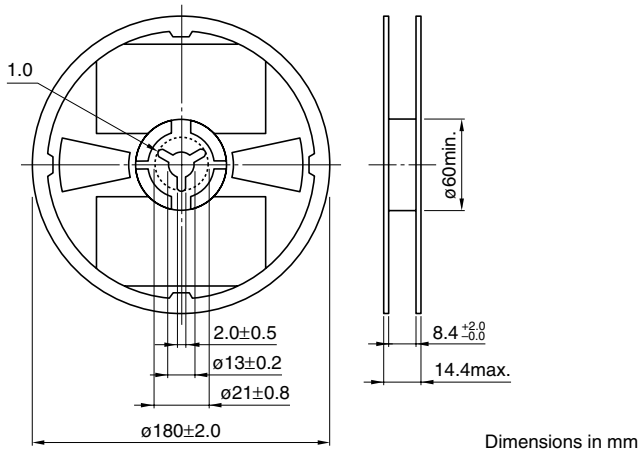

**TAPE DIMENSIONS**

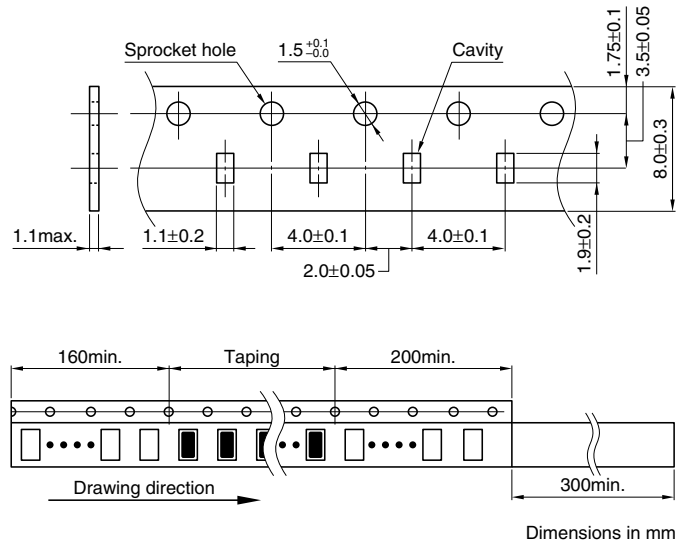

• All specifications are subject to change without notice.

# Chip Beads For Signal Line

Conformity to RoHS Directive

## MMZ Series MMZ2012

### FEATURES

- Chip bead(impeder), MMZ series offers 4 construction materials.
- Size standardized for use by automatic assembly equipment.  
No preferred orientation.
- Either flow or reflow soldering methods can be used due to electroplating of the terminal electrodes.
- High reliability due to an entirely monolithic structure.
- Closed magnetic circuit structure allows high-density installation while preventing crosstalk between circuits.
- Low DC resistance structure of electrode prevents wasteful electric power consumption.
- The products contain no lead and also support lead-free soldering.
- It is a product conforming to RoHS directive.

### APPLICATIONS

Removal of signal line noises of cellular phones, PCs, note PCs, TVs, TV tuners, STBs, audio players, DVDs, DSCs, DVCs, game machines, digital photo frames, car navigation system, PNDs, etc.

### PRODUCT IDENTIFICATION

|     |      |     |     |     |     |     |
|-----|------|-----|-----|-----|-----|-----|
| MMZ | 2012 | R   | 121 | A   | T   | □□□ |
| (1) | (2)  | (3) | (4) | (5) | (6) | (7) |

- (1) Series name
- (2) Dimensions L×W
- (3) Type name
- (4) Impedance  
121:120Ω at 100MHz
- (5) Characteristic type
- (6) Packaging style  
T:Taping
- (7) TDK internal code

### HANDLING AND PRECAUTIONS

- Before soldering, be sure to preheat components. The preheating temperature should be set so that the temperature difference between the solder temperature and product temperature does not exceed 150°C.
- After mounting components onto the printed circuit board, do not apply stress through board bending or mishandling.
- Do not expose the inductors to stray magnetic fields.
- Avoid static electricity discharge during handling.
- When hand soldering, apply the soldering iron to the printed circuit board only. Temperature of the iron tip should not exceed 350°C. Soldering time should not exceed 3 seconds.

• Conformity to RoHS Directive: This means that, in conformity with EU Directive 2002/95/EC, lead, cadmium, mercury, hexavalent chromium, and specific bromine-based flame retardants, PBB and PBDE, have not been used, except for exempted applications.

• Please contact our Sales office when your application is considered the following:  
The device's failure or malfunction may directly endanger human life (e.g. application for automobile/aircraft/medical/nuclear power devices, etc.)

• All specifications are subject to change without notice.

### MATERIAL CHARACTERISTICS

**R material:** For wide frequency applications calling for broad impedance characteristics.

For digital signal line applications calling requiring good waveform integrity. Impedance values selected for effectiveness at 10 to 200MHz.

**S material:** Standard type that features impedance characteristics similar to those of a typical ferrite core.

For signal line applications in which the blocking region is near 100MHz. Impedance values selected for effectiveness at 40 to 300MHz.

**Y material:** High frequency range type intended for the 100MHz region and above.

For signal line applications in which the signal frequency is far from the cutoff frequency. Impedance values selected for effectiveness at 80 to 400MHz.

**D material:** For applications calling for low insertion loss at low frequencies and sharply increasing impedance at high frequencies. Designed for high impedance at high frequencies (200 to 500MHz) for signal line applications.

### TYPICAL MATERIAL CHARACTERISTICS

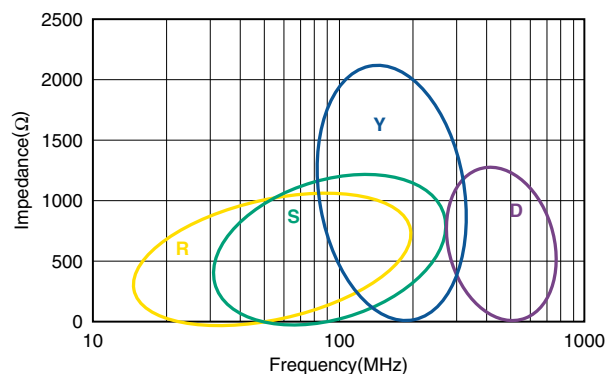

**SHAPES AND DIMENSIONS/RECOMMENDED PC BOARD**

**PATTERN**

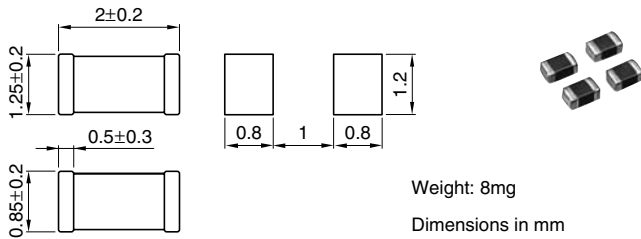

**ELECTRICAL CHARACTERISTICS**

| Part No.     | Impedance (Ω)[100MHz]* | DC resistance (Ω)max. | Rated current (mA)max. |
|--------------|------------------------|-----------------------|------------------------|
| MMZ2012R150A | 15±25%                 | 0.05                  | 1500                   |
| MMZ2012R300A | 30±25%                 | 0.05                  | 1500                   |
| MMZ2012R600A | 60±25%                 | 0.10                  | 1000                   |
| MMZ2012R121A | 120±25%                | 0.12                  | 800                    |
| MMZ2012R301A | 300±25%                | 0.15                  | 600                    |
| MMZ2012R601A | 600±25%                | 0.20                  | 500                    |
| MMZ2012R102A | 1000±25%               | 0.30                  | 500                    |
| MMZ2012S400A | 40±25%                 | 0.10                  | 1000                   |
| MMZ2012S800A | 80±25%                 | 0.10                  | 800                    |
| MMZ2012S121A | 120±25%                | 0.15                  | 800                    |
| MMZ2012S181A | 180±25%                | 0.15                  | 600                    |
| MMZ2012S301A | 300±25%                | 0.20                  | 600                    |
| MMZ2012S601A | 600±25%                | 0.30                  | 500                    |
| MMZ2012S102A | 1000±25%               | 0.35                  | 500                    |
| MMZ2012Y150B | 15±25%                 | 0.05                  | 1500                   |
| MMZ2012Y300B | 30±25%                 | 0.05                  | 1500                   |
| MMZ2012Y600B | 60±25%                 | 0.10                  | 1000                   |
| MMZ2012Y121B | 120±25%                | 0.12                  | 800                    |
| MMZ2012Y301B | 300±25%                | 0.15                  | 600                    |
| MMZ2012Y601B | 600±25%                | 0.20                  | 500                    |
| MMZ2012Y102B | 1000±25%               | 0.30                  | 500                    |
| MMZ2012Y152B | 1500±25%               | 0.40                  | 500                    |
| MMZ2012Y202B | 2000±25%               | 0.50                  | 400                    |
| MMZ2012D800B | 80±25%                 | 0.30                  | 500                    |
| MMZ2012D121B | 120±25%                | 0.30                  | 500                    |
| MMZ2012D301B | 300±25%                | 0.50                  | 400                    |

**TEMPERATURE RANGES**

|                   |               |
|-------------------|---------------|
| Operating/storage | -55 to +125°C |
|-------------------|---------------|

**PACKAGING STYLE AND QUANTITIES**

|                 |                  |
|-----------------|------------------|
| Packaging style | Quantity         |
| Taping          | 4000 pieces/reel |

**RECOMMENDED SOLDERING CONDITION  
REFLOW SOLDERING**

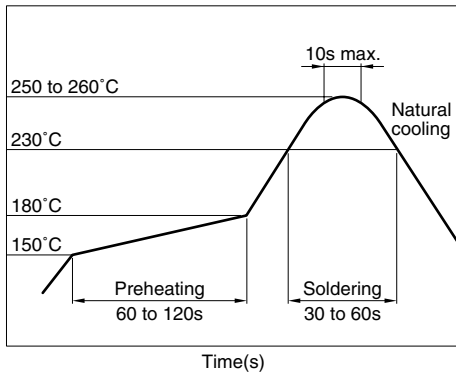

\* Test equipment: E4991A or equivalent  
 Test tool: 16192A or equivalent  
 Test temperature: 25±10°C

**TYPICAL ELECTRICAL CHARACTERISTICS  
Z, X, R vs. FREQUENCY CHARACTERISTICS**

**MMZ2012R150A**

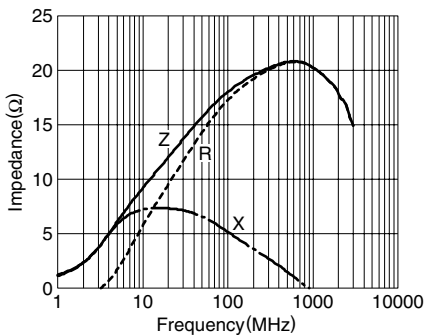

**MMZ2012R300A**

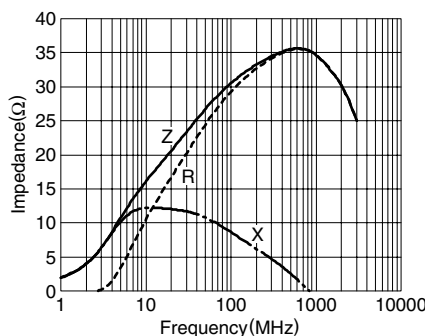

**MMZ2012R600A**

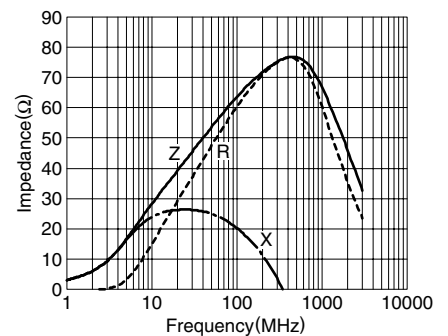

**MMZ2012R121A**

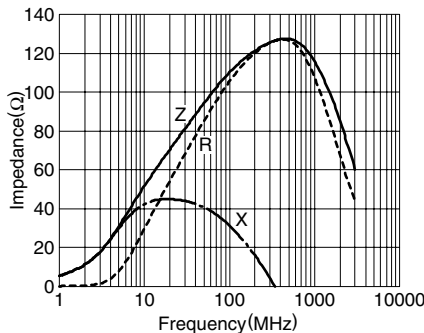

**MMZ2012R301A**

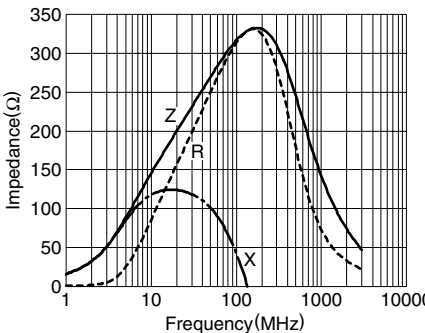

**MMZ2012R601A**

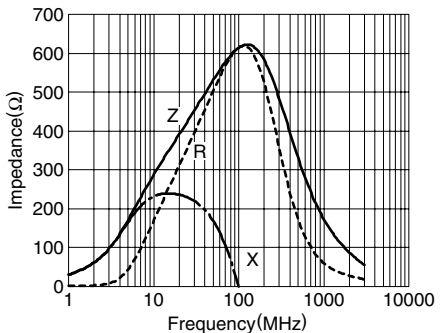

• All specifications are subject to change without notice.

### TYPICAL ELECTRICAL CHARACTERISTICS

#### Z, X, R vs. FREQUENCY CHARACTERISTICS

**MMZ2012R102A**

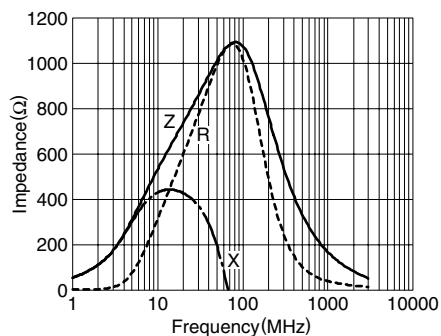

**MMZ2012S400A**

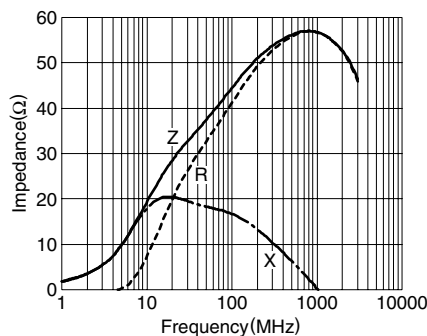

**MMZ2012S800A**

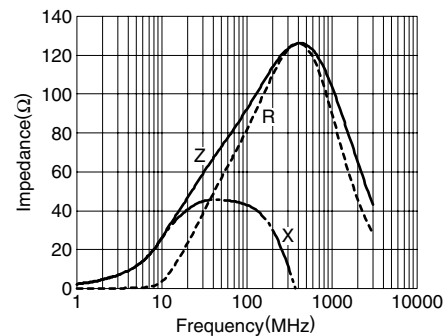

**MMZ2012S121A**

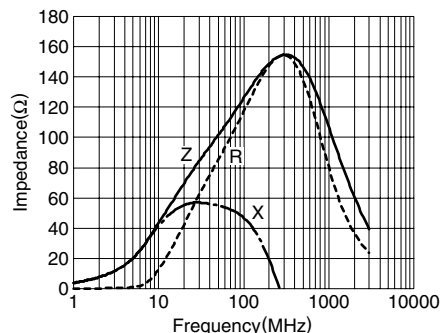

**MMZ2012S181A**

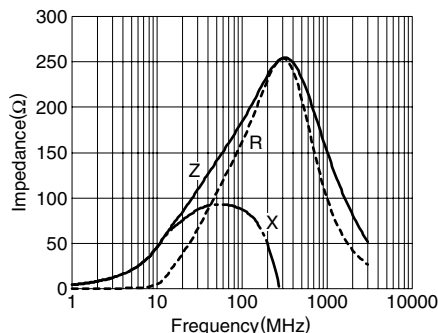

**MMZ2012S301A**

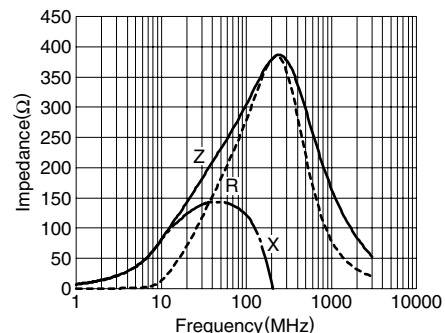

**MMZ2012S601A**

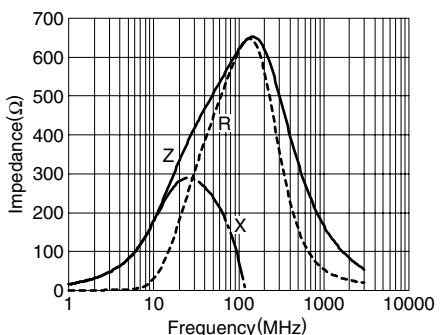

**MMZ2012S102A**

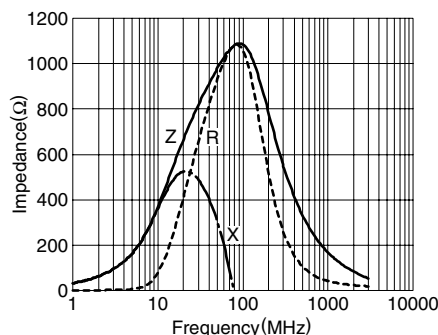

**MMZ2012Y150B**

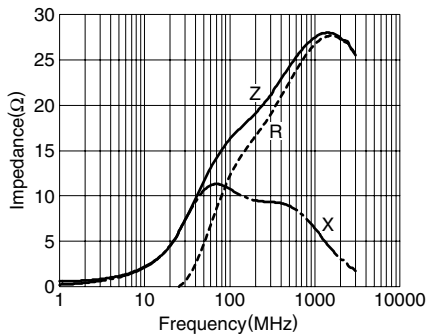

**MMZ2012Y300B**

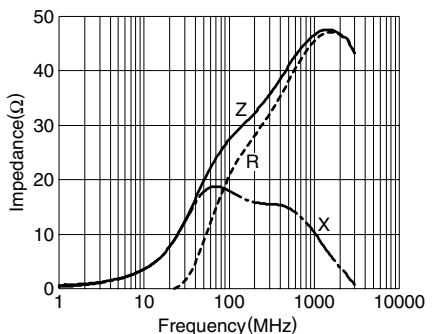

**MMZ2012Y600B**

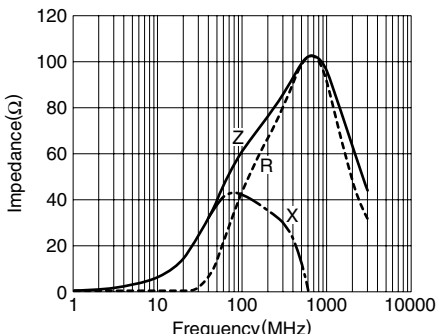

**MMZ2012Y121B**

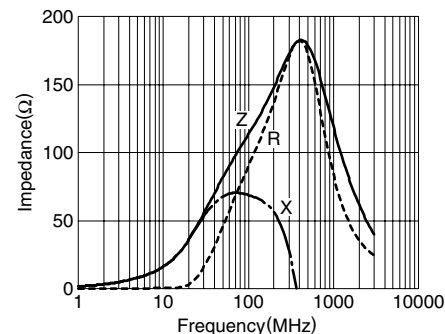

• All specifications are subject to change without notice.

**TYPICAL ELECTRICAL CHARACTERISTICS**  
**Z, X, R vs. FREQUENCY CHARACTERISTICS**  
**MMZ2012Y301B**

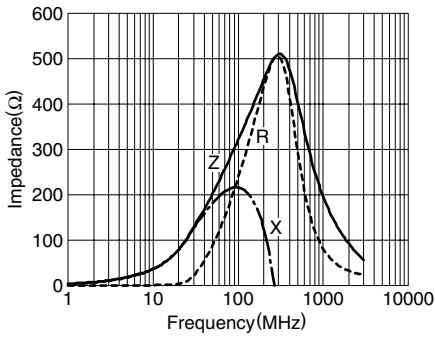

**MMZ2012Y601B**

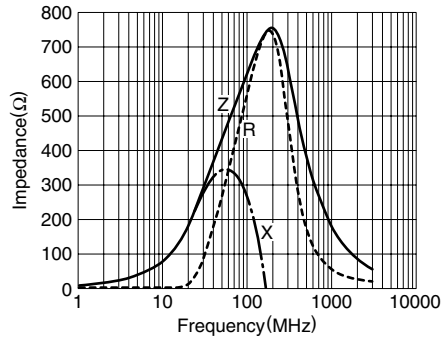

**MMZ2012Y102B**

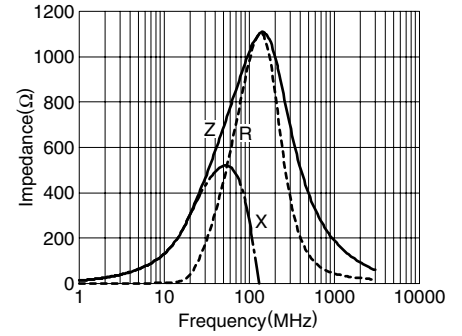

**MMZ2012Y152B**

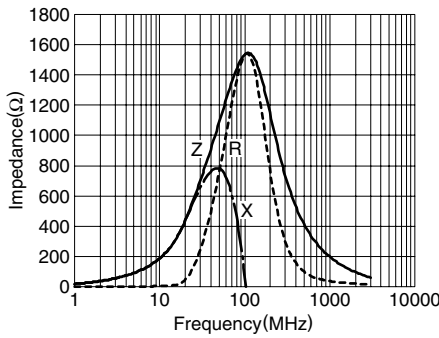

**MMZ2012Y202B**

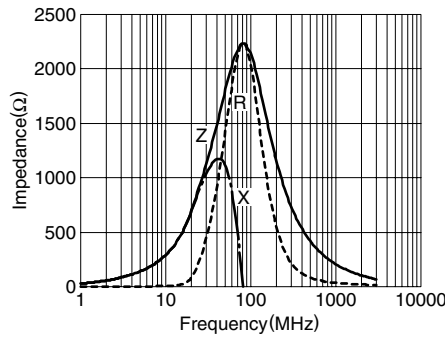

**MMZ2012D800B**

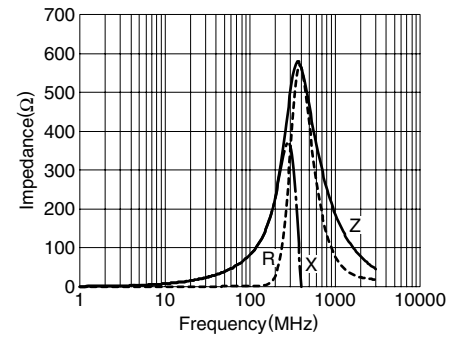

**MMZ2012D121B**

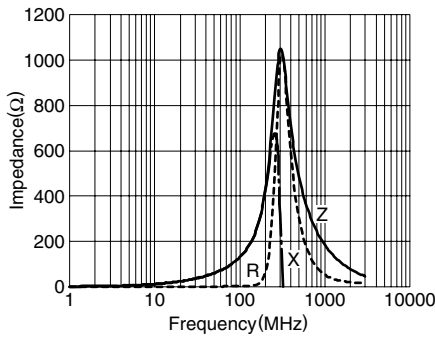

**MMZ2012D301B**

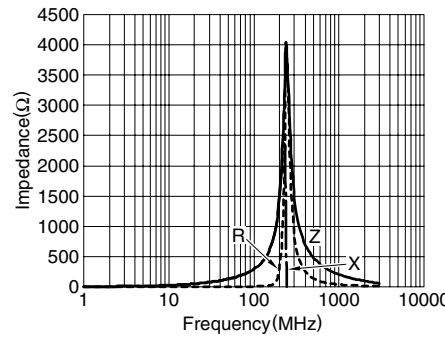

**PACKAGING STYLES**  
**REEL DIMENSIONS**

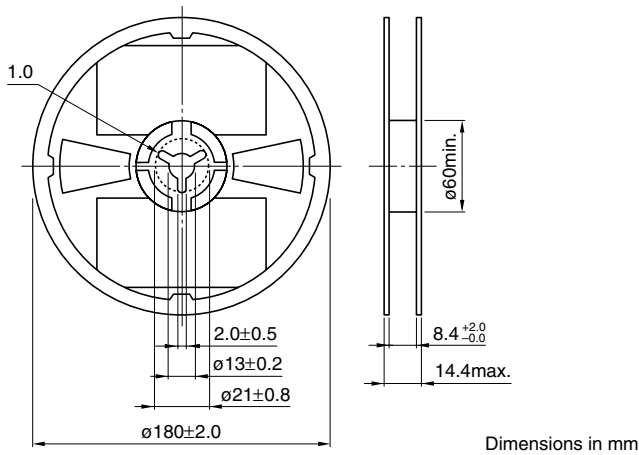

**TAPE DIMENSIONS**

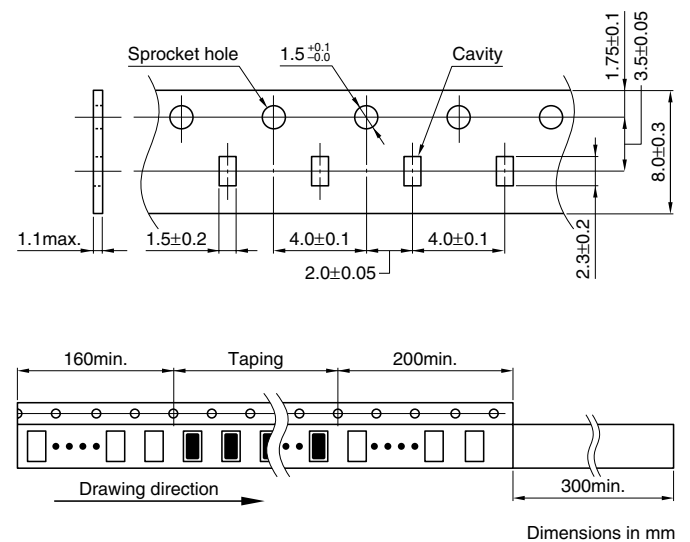

• All specifications are subject to change without notice.



# Chip Beads For Signal Line

Conformity to RoHS Directive

## MMZ Series MMZ1005-E

### FEATURES

- Compared with the existing MMZ1005 type, this new product has broad-band impedance values for higher frequency ranges.
- Size standardized for use by automatic assembly equipment. No preferred orientation.
- Electroplated terminal electrodes accommodate reflow soldering.
- High reliability due to an entirely monolithic structure.
- Closed magnetic circuit structure allows high-density installation while preventing crosstalk between circuits.
- Low DC resistance structure of electrode prevents wasteful electric power consumption.
- It is a product conforming to RoHS directive.

### APPLICATIONS

Removal of signal line noises of cellular phones, PCs, note PCs, TVs, TV tuners, STBs, audio players, DVDs, DSCs, DVCs, game machines, digital photo frames, car navigation system, PNDs, etc.

### TEMPERATURE RANGES

|                   |               |
|-------------------|---------------|
| Operating/storage | -55 to +125°C |
|-------------------|---------------|

### SHAPES AND DIMENSIONS/RECOMMENDED PC BOARD PATTERN

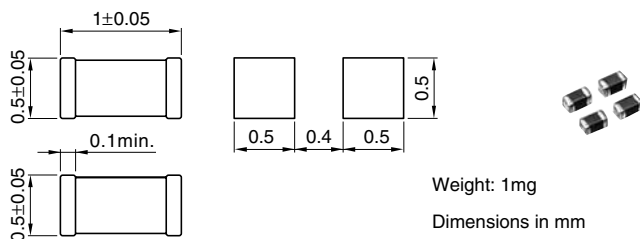

### ELECTRICAL CHARACTERISTICS

| Part No.     | Impedance(Ω)* |          | DC resistance (Ω)max. | Rated current (mA)max. |
|--------------|---------------|----------|-----------------------|------------------------|
|              | [100MHz]      | [1GHz]   |                       |                        |
| MMZ1005S601E | 600±25%       | 1000±40% | 0.65                  | 300                    |
| MMZ1005S102E | 1000±25%      | 1400±40% | 1.00                  | 250                    |
| MMZ1005S182E | 1800±25%      | 1800±40% | 1.50                  | 200                    |
| MMZ1005A601E | 600±25%       | 1400±40% | 0.80                  | 300                    |
| MMZ1005A102E | 1000±25%      | 2000±40% | 1.20                  | 250                    |
| MMZ1005A152E | 1500±25%      | 2300±40% | 1.60                  | 230                    |
| MMZ1005A182E | 1800±25%      | 2700±40% | 2.10                  | 200                    |
| MMZ1005A222E | 2200±25%      | 3000±40% | 2.20                  | 150                    |
| MMZ1005D121E | 120±25%       | 1000±40% | 0.70                  | 300                    |
| MMZ1005D221E | 220±25%       | 1700±40% | 1.00                  | 250                    |
| MMZ1005F470E | 47±25%        | 800±40%  | 0.70                  | 300                    |
| MMZ1005F750E | 75±25%        | 1500±40% | 1.00                  | 250                    |
| MMZ1005F121E | 120±25%       | 2300±40% | 1.50                  | 200                    |

\* Test equipment: E4991A or equivalent  
Test tool: 16192A or equivalent  
Test temperature: 25±10°C

- Conformity to RoHS Directive: This means that, in conformity with EU Directive 2002/95/EC, lead, cadmium, mercury, hexavalent chromium, and specific bromine-based flame retardants, PBB and PBDE, have not been used, except for exempted applications.

- Please contact our Sales office when your application is considered the following:  
The device's failure or malfunction may directly endanger human life (e.g. application for automobile/aircraft/medical/nuclear power devices, etc.)

- All specifications are subject to change without notice.

### PRODUCT IDENTIFICATION

|     |      |     |     |     |     |     |
|-----|------|-----|-----|-----|-----|-----|
| MMZ | 1005 | S   | 601 | E   | T   | □□□ |
| (1) | (2)  | (3) | (4) | (5) | (6) | (7) |

- (1) Series name
- (2) Dimensions L×W
- (3) Type name
- (4) Impedance  
601:600Ω at 100MHz
- (5) Characteristic type
- (6) Packaging style  
T:Taping
- (7) TDK internal code

### PACKAGING STYLE AND QUANTITIES

| Packaging style | Quantity          |
|-----------------|-------------------|
| Taping          | 10000 pieces/reel |

### HANDLING AND PRECAUTIONS

- Before soldering, be sure to preheat components. The preheating temperature should be set so that the temperature difference between the solder temperature and product temperature does not exceed 150°C.
- After mounting components onto the printed circuit board, do not apply stress through board bending or mishandling.
- Do not expose the inductors to stray magnetic fields.
- Avoid static electricity discharge during handling.
- When hand soldering, apply the soldering iron to the printed circuit board only. Temperature of the iron tip should not exceed 350°C. Soldering time should not exceed 3 seconds.

### RECOMMENDED SOLDERING CONDITION REFLOW SOLDERING

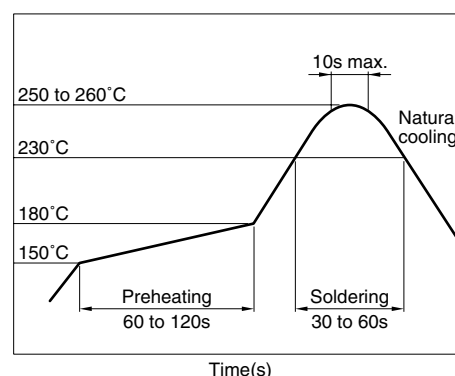

### TYPICAL ELECTRICAL CHARACTERISTICS

### Z FREQUENCY CHARACTERISTICS(DIFFERS ACCORDING TO SERIES)

#### MMZ1005S-E SERIES

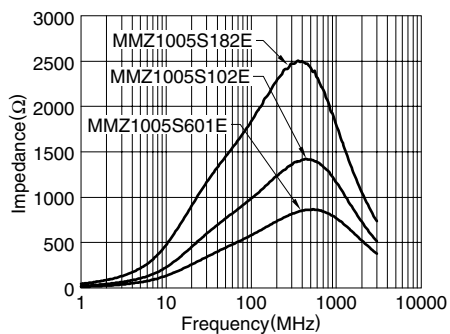

#### MMZ1005A-E SERIES

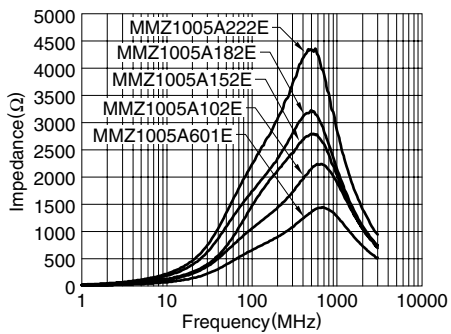

#### MMZ1005D-E SERIES

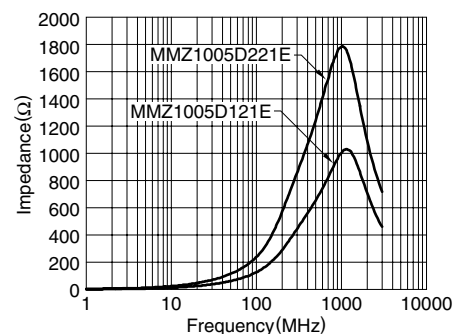

#### MMZ1005F-E SERIES

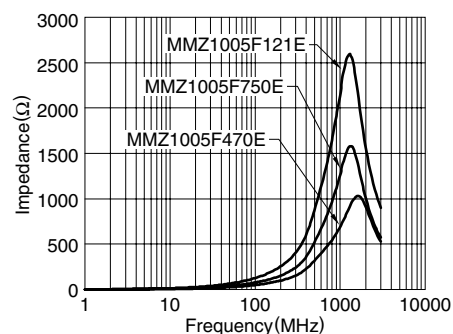

### Z, X, R vs. FREQUENCY CHARACTERISTICS

#### MMZ1005S601E

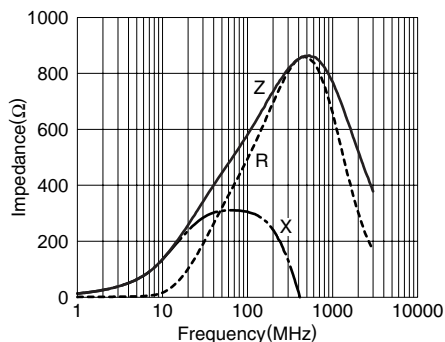

#### MMZ1005S102E

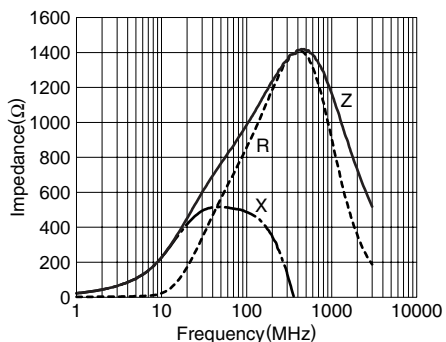

#### MMZ1005S182E

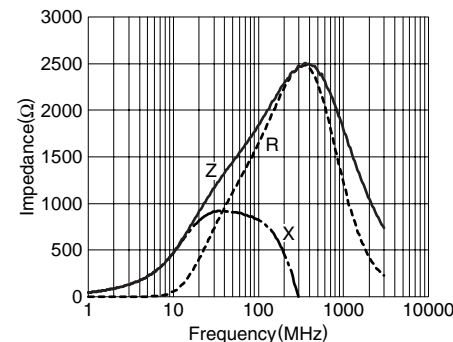

#### MMZ1005A601E

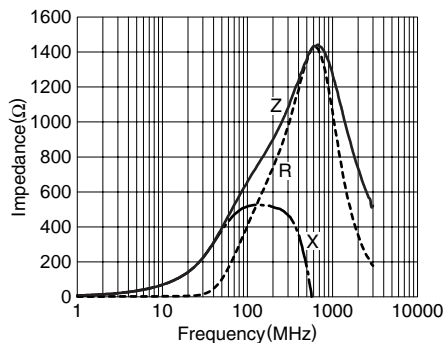

#### MMZ1005A102E

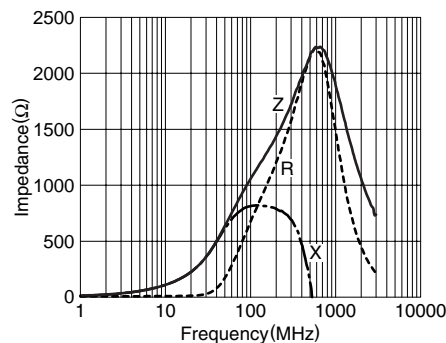

#### MMZ1005A152E

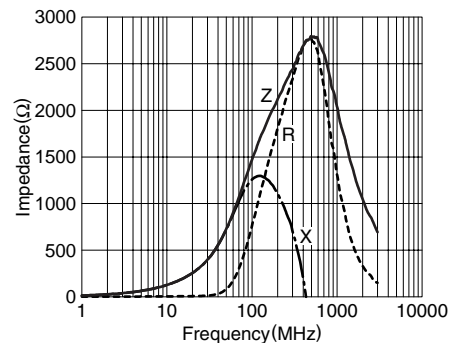

• All specifications are subject to change without notice.

**TYPICAL ELECTRICAL CHARACTERISTICS**  
**Z, X, R vs. FREQUENCY CHARACTERISTICS**

**MMZ1005A182E**

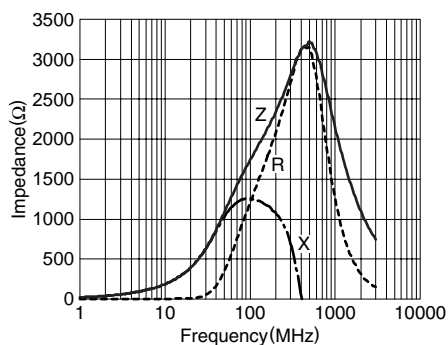

**MMZ1005A222E**

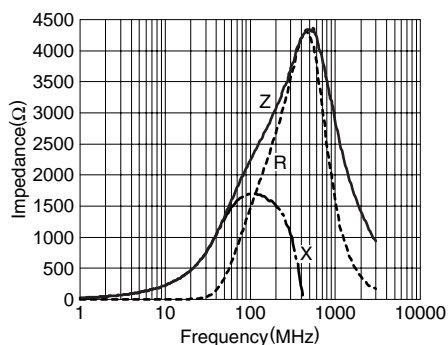

**MMZ1005D121E**

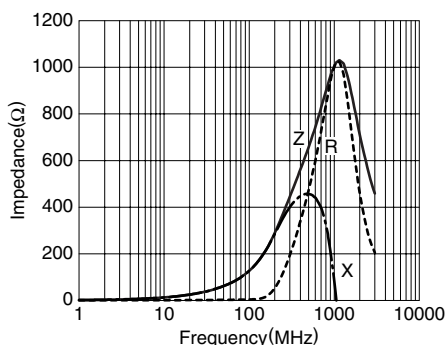

**MMZ1005D221E**

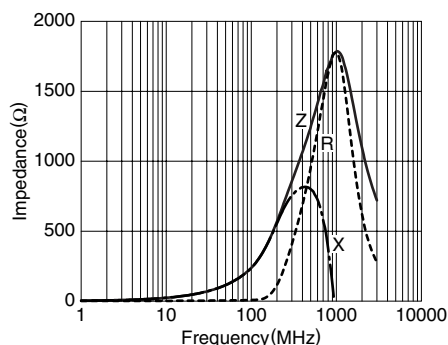

**MMZ1005F470E**

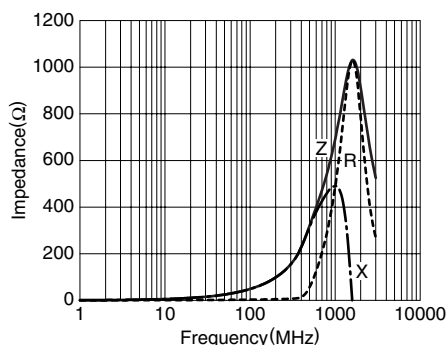

**MMZ1005F750E**

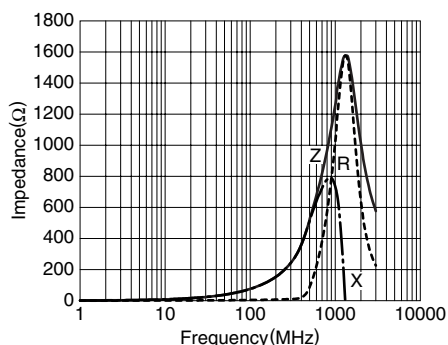

**MMZ1005F121E**

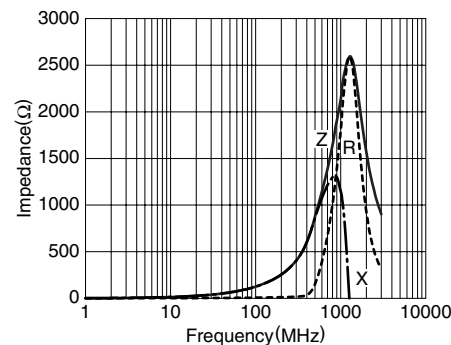

**PACKAGING STYLES**  
**REEL DIMENSIONS**

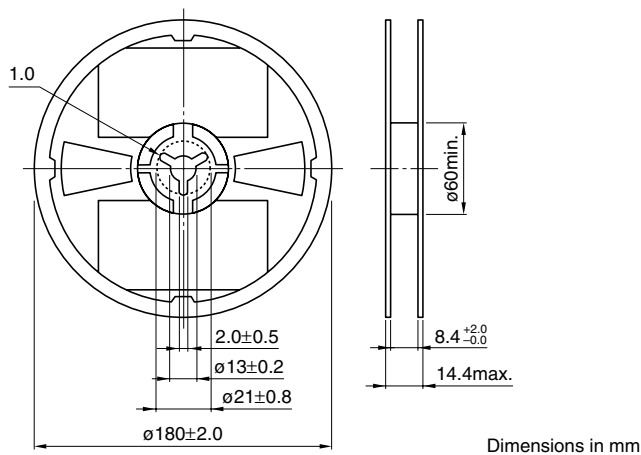

Dimensions in mm

**TAPE DIMENSIONS**

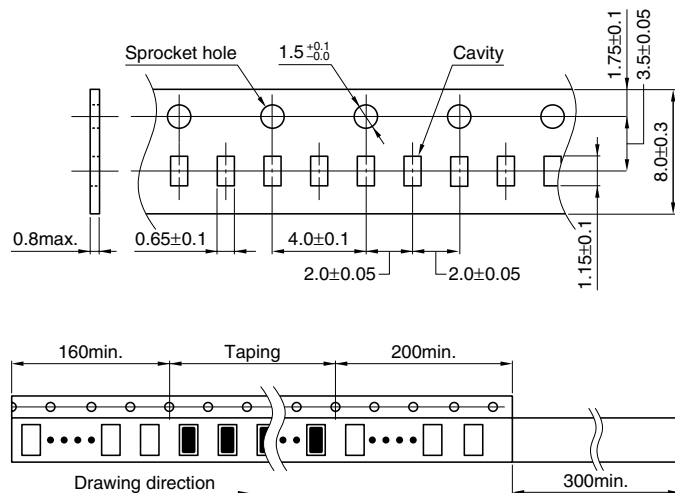

Dimensions in mm

• All specifications are subject to change without notice.