

MAXIM

2.5V, 1µA, 460kbps, RS-232-Compatible Transceivers

MAX3316-MAX3319

General Description

The MAX3316-MAX3319 transceivers have a proprietary low-dropout transmitter output stage enabling RS-232-compatible performance from +2.25V to +3.0V with a dual-charge pump. These devices require only four 0.1µF capacitors, and are guaranteed to operate at data rates up to 460kbps.

The MAX3318/MAX3319 achieve a 1µA supply current using Maxim's revolutionary AutoShutdown Plus™ feature. These devices automatically enter a low-power shutdown mode when the RS-232 cable is disconnected or the transmitters of the connected peripherals are inactive for more than 30 seconds. They turn on again when they sense a valid transition at any transmitter or receiver input. AutoShutdown Plus saves power without changes to the existing BIOS or operating system. The MAX3318 is a 2-Tx/2-Rx device while the MAX3319 is a 1-Tx/1-Rx device. These devices also feature a logic-level output (READY) that asserts when the charge pump is regulating and the device is ready to begin transmitting.

The MAX3316/MAX3317 are 2-Tx/2-Rx transceivers. The MAX3317 features a 1µA shutdown mode that can be entered by driving SHDN low. The MAX3317's receivers remain active while in shutdown mode, allowing external devices such as modems to be monitored using only 1µA supply current.

These devices are available in space-saving packages: MAX3316 (16-pin SSOP and 20-pin TSSOP), MAX3317/MAX3318 (20-pin SSOP and 20-pin TSSOP), and MAX3319 (16-pin SSOP).

Applications

- Palmtop Computers
- Hand-Held Instruments
- Pagers
- Cellular Phones
- GPS
- Handy Terminals
- Hand-Held Electronic Books

AutoShutdown Plus is a trademark of Maxim Integrated Products.

Pin Configurations appear at end of data sheet.

Features

- ◆ AutoShutdown Plus (MAX3318/MAX3319)
- ◆ 300µA Operating Supply Current
- ◆ 1µA Low-Power Shutdown with Receivers Active
- ◆ Guaranteed 460kbps Data Rate
- ◆ Guaranteed 4V/µs Slew Rate
- ◆ RS-232 Compatible Down to 2.25V

Ordering Information

PART	TEMP. RANGE	PIN-PACKAGE
MAX3316CUP	0°C to +70°C	20 TSSOP
MAX3316CAE	0°C to +70°C	16 SSOP
MAX3316EUP	-40°C to +85°C	20 TSSOP
MAX3316EAE	-40°C to +85°C	16 SSOP

Ordering Information continued at end of data sheet.

Typical Application Circuits

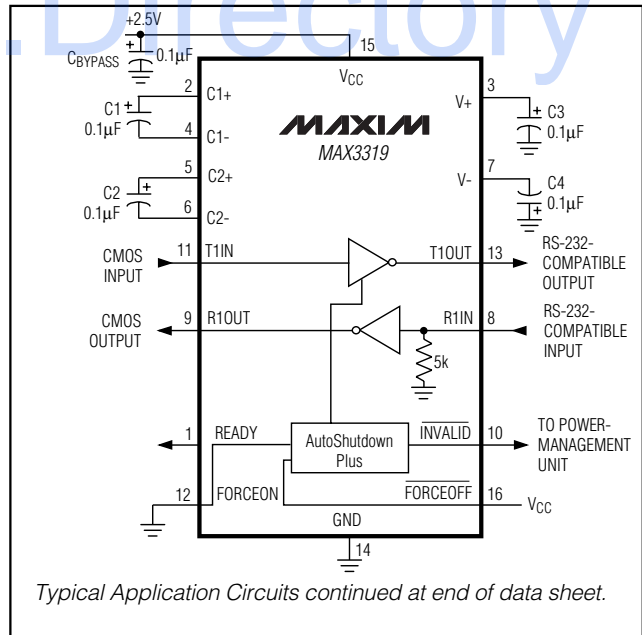

Selector Guide

PART	NO. OF DRIVERS/ RECEIVERS	GUARANTEED DATA RATE (kbps)	READY OUTPUT	SHUTDOWN	AutoShutdown Plus
MAX3316	2/2	460	—	—	—
MAX3317	2/2	460	—	✓	—
MAX3318	2/2	460	✓	—	✓
MAX3319	1/1	460	✓	—	✓

2.5V, 1μA, 460kbps, RS-232-Compatible Transceivers

ABSOLUTE MAXIMUM RATINGS

V _{CC} to GND	-0.3V to +6V	Short-Circuit Duration, T _{OUT} to GND.....	Continuous
V+ to GND (Note 1)	-0.3V to +7V	Continuous Power Dissipation (T _A = +70°C)	
V- to GND (Note 1)	-7V to +0.3V	16-Pin SSOP (derate 7.14mW/°C above +70°C).....	571mW
V+ + IV-I (Note 1)	+13V	20-Pin SSOP (derate 8.00mW/°C above +70°C).....	640mW
Input Voltages		20-Pin TSSOP (derate 7.00mW/°C above +70°C).....	559mW
T _{IN} , EN, SHDN, FORCEON,		Operating Temperature Ranges	
FORCEOFF to GND	-0.3V to +6V	MAX331_C_	0°C to +70°C
R _{IN} to GND	±25V	MAX331_E_	-40°C to +85°C
Output Voltages		Storage Temperature Range	-65°C to +150°C
T _{OUT} to GND	±13.2V	Die Temperature	+150°C
R _{OUT} , INVALID, READY to GND	-0.3V to (V _{CC} + 0.3V)	Lead Temperature (soldering, 10s)	+300°C

Note 1: V+ and V- can have maximum magnitudes of 7V, but their absolute difference cannot exceed 13V.

Stresses beyond those listed under "Absolute Maximum Ratings" may cause permanent damage to the device. These are stress ratings only, and functional operation of the device at these or any other conditions beyond those indicated in the operational sections of the specifications is not implied. Exposure to absolute maximum rating conditions for extended periods may affect device reliability.

ELECTRICAL CHARACTERISTICS

(V_{CC} = +2.25V to +3.0V, C1–C4 = 0.1μF, T_A = T_{MIN} to T_{MAX}, unless otherwise noted. Typical values are at V_{CC} = +2.5V, T_A = +25°C.)

PARAMETER	SYMBOL	CONDITIONS	MIN	TYP	MAX	UNITS
DC CHARACTERISTICS (V _{CC} = +2.5V, T _A = +25°C)						
AutoShutdown Plus Supply Current		FORCEON = GND, FORCEOFF = V _{CC} , all R _{IN} idle, all T _{IN} idle (MAX3318/MAX3319)		1	10	μA
Shutdown Supply Current		SHDN = GND (MAX3317), FORCEOFF = GND (MAX3318/MAX3319)		1	10	μA
Supply Current		SHDN = V _{CC} , no load (MAX3317), FORCEON = FORCEOFF = V _{CC} , no load (MAX3318/MAX3319)		0.3	1	mA
LOGIC INPUTS						
Input Logic Threshold Low		T _{IN} , EN, SHDN, FORCEON, FORCEOFF		0.3 × V _{CC}		V
Input Logic Threshold High		T _{IN} , EN, SHDN, FORCEON, FORCEOFF	0.7 × V _{CC}			V
Transmitter Input Hysteresis			0.3			V
Input Leakage Current		T _{IN} , EN, SHDN, FORCEON, FORCEOFF		±0.01	±1	μA
RECEIVER OUTPUTS						
Output Leakage Current		EN = V _{CC} (MAX3317), receivers disabled		±0.05	±10	μA
Output Voltage Low		I _{OUT} = 0.5mA	0.1 × V _{CC}			V
Output Voltage High		I _{OUT} = -0.5mA	0.9 × V _{CC}			V
RECEIVER INPUTS						
Input Voltage Range			-25	+25		V
Input Threshold Low		T _A = +25°C	0.3 × V _{CC}			V
Input Threshold High		T _A = +25°C	0.7 × V _{CC}			V
Input Hysteresis			0.3			V
Input Resistance		T _A = +25°C	3	5	7	kΩ
TRANSMITTER OUTPUTS						
Output Voltage Swing		All transmitter outputs loaded with 3kΩ to ground	±3.7	±4		V

2.5V, 1μA, 460kbps, RS-232-Compatible Transceivers

MAX3316-MAX3319

ELECTRICAL CHARACTERISTICS (continued)

($V_{CC} = +2.25V$ to $+3.0V$, $C1-C4 = 0.1\mu F$, $T_A = T_{MIN}$ to T_{MAX} , unless otherwise noted. Typical values are at $V_{CC} = +2.5V$, $T_A = +25^\circ C$.)

PARAMETER	SYMBOL	CONDITIONS		MIN	TYP	MAX	UNITS
Output Resistance		$V_{CC} = 0$, transmitter output = $\pm 2V$		300	10M		Ω
Output Short-Circuit Current					± 25	± 60	mA
Output Leakage Current		$V_{CC} = 0$ or $2.25V$ to $3.0V$, $V_{OUT} = \pm 12V$, transmitters disabled				± 25	μA
AutoShutdown Plus (FORCEON = GND, FORCEOFF = V_{CC}) (MAX3318/MAX3319)							
Receiver Input Threshold to $\overline{INVALID}$ Output High		Figure 4a	Positive threshold			2.7	V
			Negative threshold			-2.7	
Receiver Input Threshold to $\overline{INVALID}$ Output Low		Figure 4a			-0.3	0.3	V
$\overline{INVALID}$, READY Output Voltage Low		$I_{OUT} = 0.5mA$				$0.1 \times V_{CC}$	V
$\overline{INVALID}$, READY Output Voltage High		$I_{OUT} = -0.5mA$		$0.9 \times V_{CC}$			V
Receiver Positive or Negative Threshold to $\overline{INVALID}$ High	t_{INVH}	Figure 4b			1		μs
Receiver Positive or Negative Threshold to $\overline{INVALID}$ Low	t_{INVL}	Figure 4b			30		μs
Receiver or Transmitter Edge to Transmitters Enabled	t_{WU}	Figure 4b (Note 2)			100		μs
Receiver or Transmitter Edge to Transmitters Shutdown	$t_{AUTO-SHDN}$	$V_{CC} = 2.5V$, Figure 4b (Note 2)		15	30	60	s

TIMING CHARACTERISTICS

($V_{CC} = +2.25V$ to $+3.0V$, $C1-C4 = 0.1\mu F$, $T_A = T_{MIN}$ to T_{MAX} , unless otherwise noted. Typical values are at $V_{CC} = +2.5V$, $T_A = +25^\circ C$.)

PARAMETER	SYMBOL	CONDITIONS	MIN	TYP	MAX	UNITS
Maximum Data Rate		$R_L = 3k\Omega$, $C_L = 1000pF$, one transmitter switching	460			kbps
Receiver Propagation Delay	t_{PHL}	R_{IN} to R_{OUT} , $C_L = 150pF$			0.175	μs
	t_{PLH}				0.175	
Receiver Output Enable Time		Normal operation (MAX3317)			250	ns
Receiver Output Disable Time		Normal operation (MAX3317)			250	ns
Transmitter Skew	$ t_{PHL} - t_{PLH} $	(Note 3)			100	ns
Receiver Skew	$ t_{PHL} - t_{PLH} $				50	ns

2.5V, 1μA, 460kbps, RS-232-Compatible Transceivers

TIMING CHARACTERISTICS (continued)

($V_{CC} = +2.25V$ to $+3.0V$, $C_1-C_4 = 0.1\mu F$, $T_A = T_{MIN}$ to T_{MAX} , unless otherwise noted. Typical values are at $V_{CC} = +2.5V$, $T_A = +25^\circ C$.)

PARAMETER	SYMBOL	CONDITIONS	MIN	TYP	MAX	UNITS
Transition-Region Slew Rate		$V_{CC} = 2.5V$, $T_A = +25^\circ C$, $R_L = 3k\Omega$ to $7k\Omega$, one transmitter switching, measured from $+3V$ to $-3V$ or $-3V$ to $+3V$, $C_L = 150pF$ to $2500pF$	4		30	$V/\mu s$

Note 2: A transmitter/receiver edge is defined as a transition through the transmitter/receiver input logic thresholds.

Note 3: Transmitter skew is measured at the transmitter zero crosspoints.

Typical Operating Characteristics

($V_{CC} = +2.5V$, $C_1-C_4 = 0.1\mu F$, 460kbps data rate, all transmitters loaded with $3k\Omega$, $T_A = +25^\circ C$, unless otherwise noted.)

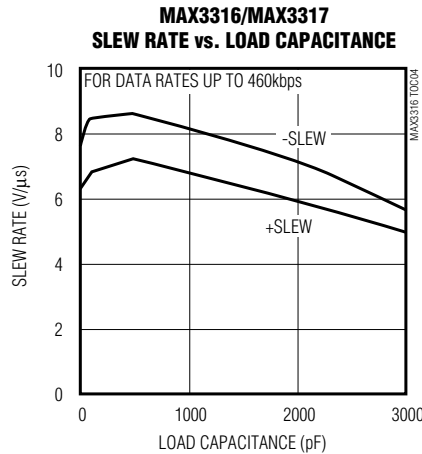
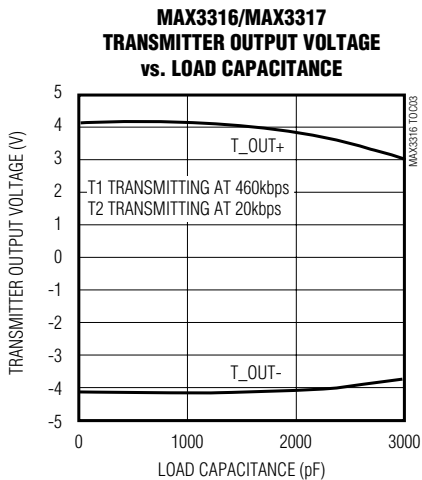
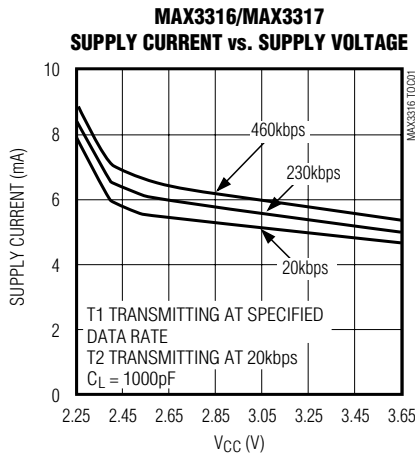

2.5V, 1 μ A, 460kbps, RS-232-Compatible Transceivers

MAX3316-MAX3319

Typical Operating Characteristics (continued)

($V_{CC} = +2.5V$, $C_1-C_4 = 0.1\mu F$, 460kbps data rate, all transmitters loaded with $3k\Omega$, $T_A = +25^\circ C$, unless otherwise noted.)

**MAX3316/MAX3317
OPERATING SUPPLY CURRENT
vs. LOAD CAPACITANCE**



**MAX3318/MAX3319
SUPPLY CURRENT vs. SUPPLY VOLTAGE**



**MAX3318/MAX3319
TRANSMITTER OUTPUT VOLTAGE
vs. SUPPLY VOLTAGE**

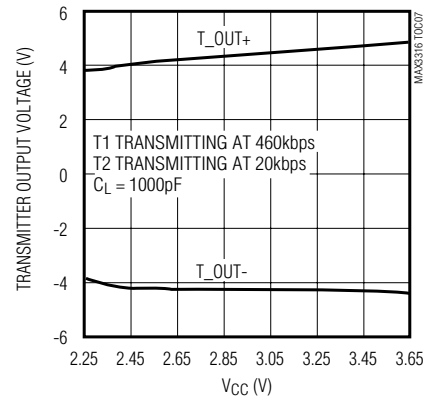

**MAX3318/MAX3319
TRANSMITTER OUTPUT VOLTAGE
vs. LOAD CAPACITANCE**



**MAX3318/MAX3319
SLEW RATE vs. LOAD CAPACITANCE**



**MAX3318/MAX3319
OPERATING SUPPLY CURRENT
vs. LOAD CAPACITANCE**

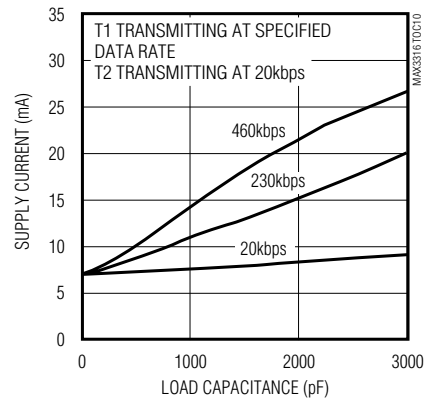

2.5V, 1μA, 460kbps, RS-232-Compatible Transceivers

Typical Operating Characteristics (continued)

(V_{CC} = +2.5V, C1-C4 = 0.1μF, 460kbps data rate, all transmitters loaded with 3kΩ, T_A = +25°C, unless otherwise noted.)

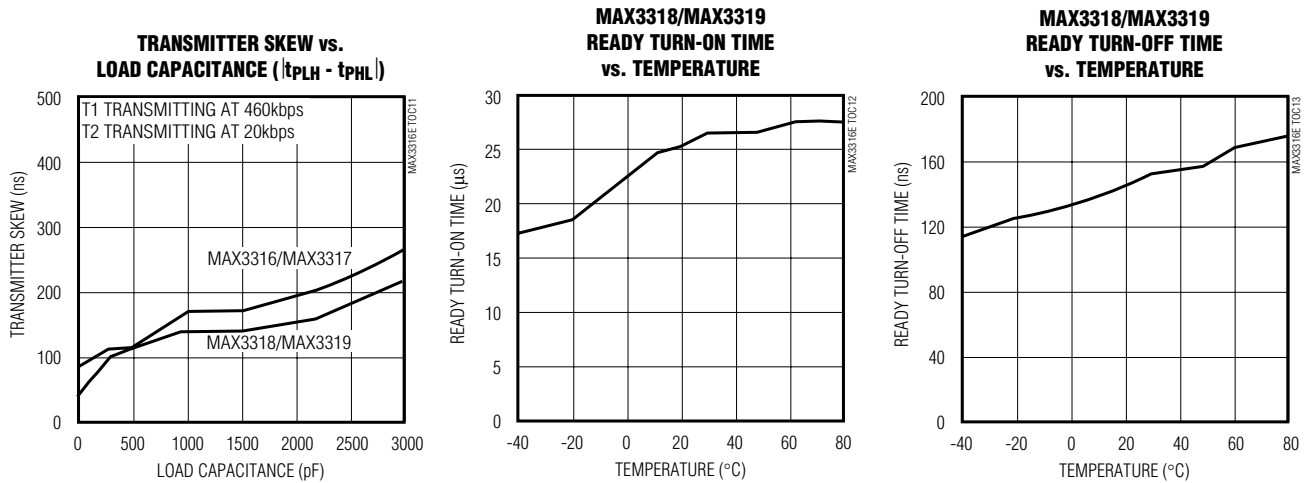

Pin Description

PIN					NAME	FUNCTION
MAX3316		MAX3317	MAX3318	MAX3319		
SSOP	TSSOP	SSOP/ TSSOP	SSOP/ TSSOP	SSOP		
1	2	2	2	2	C1+	Positive Terminal of Voltage-Doubler Charge-Pump Capacitor
2	3	3	3	3	V+	+2 × V _{CC} Generated by the Charge Pump
3	4	4	4	4	C1-	Negative Terminal of Voltage-Doubler Charge-Pump Capacitor
4	5	5	5	5	C2+	Positive Terminal of Inverting Charge-Pump Capacitor
5	6	6	6	6	C2-	Negative Terminal of Inverting Charge-Pump Capacitor
6	7	7	7	7	V-	-2 × V _{CC} Generated by the Charge Pump
7, 14	8, 17	8, 17	8, 17	13	T_OUT	RS-232 Transmitter Outputs
8, 13	9, 16	9, 16	9, 16	8	R_IN	RS-232 Receiver Inputs
9, 12	12, 15	10, 15	10, 15	9	R_OUT	CMOS Receiver Outputs
10, 11	13, 14	12, 13	12, 13	11	T_IN	CMOS Transmitter Inputs
15	18	18	18	14	GND	Ground
16	19	19	19	15	V _{CC}	+2.25V to +3.0V Single-Supply Voltage
—	—	1	—	—	$\overline{\text{EN}}$	Receiver Enable, Active Low
—	1, 10, 11, 20	11, 14	—	—	N.C.	No Connection

2.5V, 1μA, 460kbps, RS-232-Compatible Transceivers

MAX3316-MAX3319

Pin Description (continued)

PIN					NAME	FUNCTION
MAX3316		MAX3317 SSOP/ TSSOP	MAX3318 SSOP/ TSSOP	MAX3319 SSOP		
SSOP	TSSOP					
—	—	20	—	—	SHDN	Shutdown Control, Active Low
—	—	—	1	1	READY	Ready to Transmit Output, Active High. READY is enabled high when V ₋ goes below -2.75V and the device is ready to transmit.
—	—	—	11	10	INVALID	Valid Signal Detector Output, Active Low. A logic high indicates that a valid RS-232 level is present on a receiver input.
—	—	—	14	12	FORCEON	Force-On Input, Active High. Drive high to override AutoShutdown Plus, keeping transmitters and receivers on ($\overline{\text{FORCEOFF}}$ must be high) (Table 1).
—	—	—	20	16	$\overline{\text{FORCEOFF}}$	Force-Off Input, Active Low. Drive low to shut down transmitters, receivers, and charge pump. This overrides AutoShutdown Plus and FORCEON (Table 1).

Detailed Description

Dual Charge-Pump Voltage Converter

The MAX3316–MAX3319s' internal power supply consists of a regulated dual charge pump that provides output voltages of +4.4V (doubling charge pump) and -4.3V (inverting charge pump), over the +2.25V to +3.0V input voltage range. The charge pump operates in discontinuous mode: if the output voltages are less than 4.4V, the charge pump is enabled; if the output voltages exceed 4.4V, the charge pump is disabled. Each charge pump requires a flying capacitor (C1, C2) and a reservoir capacitor (C3, C4) to generate the V₊ and V₋ supplies.

The READY output (MAX3318/MAX3319) is low when the charge pumps are disabled in shutdown mode. The READY signal asserts high when V₋ goes below -2.75V.

RS-232-Compatible Transmitters

The MAX3316–MAX3319s' transmitters are inverting level translators that convert CMOS-logic levels to RS-232-compatible voltage levels. They guarantee a 460kbps data rate with worst-case loads of 3kΩ in parallel with 1000pF, providing compatibility with PC-to-PC communication software (such as LapLink™).

The MAX3317's transmitters are turned off (high impedance) when $\overline{\text{SHDN}}$ is asserted low, putting the device in shutdown mode. The MAX3318/MAX3319s' transmitters

are turned off (high impedance) when $\overline{\text{FORCEOFF}}$ is asserted low, or when the AutoShutdown Plus circuitry senses that all receiver and transmitter inputs are inactive for more than 30 seconds.

The transmitter outputs can be driven to ±12V when power is off. The transmitter inputs do not have internal pullup resistors. Connect unused inputs to GND or V_{CC}.

Figure 1a shows an RS-232-compatibility circuit and Figure 1b shows MAX3316–MAX3319 transmitter output compatibility with an RS-232 receiver.

RS-232 Receivers

The MAX3316–MAX3319s' receivers convert RS-232 signal levels into CMOS-logic output levels. The receivers are rated to receive signals up to ±25V. The MAX3316/MAX3318/MAX3319s' receivers feature inverting outputs that always remain active (Table 1). The MAX3317's receivers have inverting, three-state outputs. In shutdown, the receivers can be active or inactive (Table 2).

The MAX3318/MAX3319 feature an $\overline{\text{INVALID}}$ output that is asserted low when no valid RS-232 voltage levels have been detected on all receiver inputs. Because $\overline{\text{INVALID}}$ indicates the receiver's input condition, it is independent of the states of FORCEON and $\overline{\text{FORCEOFF}}$.

LapLink is a trademark of Traveling Software.

2.5V, 1μA, 460kbps, RS-232-Compatible Transceivers

Table 1. Output Control Truth Table (MAX3318/MAX3319)

OPERATION STATUS	FORCEON	$\overline{\text{FORCEOFF}}$	VALID RECEIVER LEVEL	RECEIVER OR TRANSMITTER EDGE WITHIN 30s	T_OUT	R_OUT
Shutdown (Forced Off)	X	0	X	X	High-Z	Active
Normal Operation (Forced On)	1	1	X	X	Active	Active
Normal Operation (AutoShutdown Plus)	0	1	X	Yes	Active	Active
Shutdown (AutoShutdown Plus)	0	1	X	No	High-Z	Active
Normal Operation	$\overline{\text{INVALID}}^*$	1	Yes	X	Active	Active
Normal Operation	$\overline{\text{INVALID}}^*$	1	X	Yes	Active	Active
Shutdown	$\overline{\text{INVALID}}^*$	1	No	No	High-Z	Active
Normal Operation (AutoShutdown)	$\overline{\text{INVALID}}^{**}$	$\overline{\text{INVALID}}^{**}$	Yes	X	Active	Active
Shutdown (AutoShutdown)	$\overline{\text{INVALID}}^{**}$	$\overline{\text{INVALID}}^{**}$	No	X	High-Z	Active

X = Don't care

* $\overline{\text{INVALID}}$ connected to FORCEON

** $\overline{\text{INVALID}}$ connected to FORCEON and $\overline{\text{FORCEOFF}}$

Table 2. Shutdown and Enable Control Truth Table (MAX3317)

$\overline{\text{SHDN}}$	$\overline{\text{EN}}$	T_OUT	R_OUT
0	0	High-Z	Active
0	1	High-Z	High-Z
1	0	Active	Active
1	1	Active	High-Z

MAX3317 Shutdown Mode

Supply current falls to less than 1μA in shutdown mode ($\overline{\text{SHDN}} = \text{low}$). When shut down, the device's charge pumps are turned off, V+ is pulled down to V_{CC}, V- is pulled to ground, and the transmitter outputs are disabled (high impedance). The time required to exit shutdown is typically 30μs, as shown in Figure 2. Connect $\overline{\text{SHDN}}$ to V_{CC} if the shutdown mode is not used; $\overline{\text{SHDN}}$ has no effect on R_OUT.

MAX3318/MAX3319 AutoShutdown Plus Mode

Maxim's AutoShutdown Plus feature on the MAX3318/MAX3319 allows the supply current to fall to 1μA. These devices will enter the AutoShutdown Plus mode if $\overline{\text{FORCEOFF}}$ is high, FORCEON is low, and they do not sense a valid signal transition on any receiver or transmitter input for 30 seconds. This may occur if the RS-232 cable is disconnected or if the peripheral transmitters are turned off, and the UART driving the transmitter inputs is inactive. The system turns on again when a valid transition is applied to any RS-232 receiver or transmitter input. As a result, the system saves power without changes to the existing BIOS or operating system.

Figure 4a depicts valid and invalid RS-232 receiver voltage levels. $\overline{\text{INVALID}}$ indicates the receiver input's condition and is independent of FORCEON and $\overline{\text{FORCEOFF}}$ states. Figure 3 and Table 1 summarize the operating modes of the MAX3318/MAX3319. FORCEON and $\overline{\text{FORCEOFF}}$ override AutoShutdown Plus circuitry. When neither control is asserted, the IC selects between these states automatically, based on the last receiver or transmitter edge received.

2.5V, 1μA, 460kbps, RS-232-Compatible Transceivers

MAX3316-MAX3319

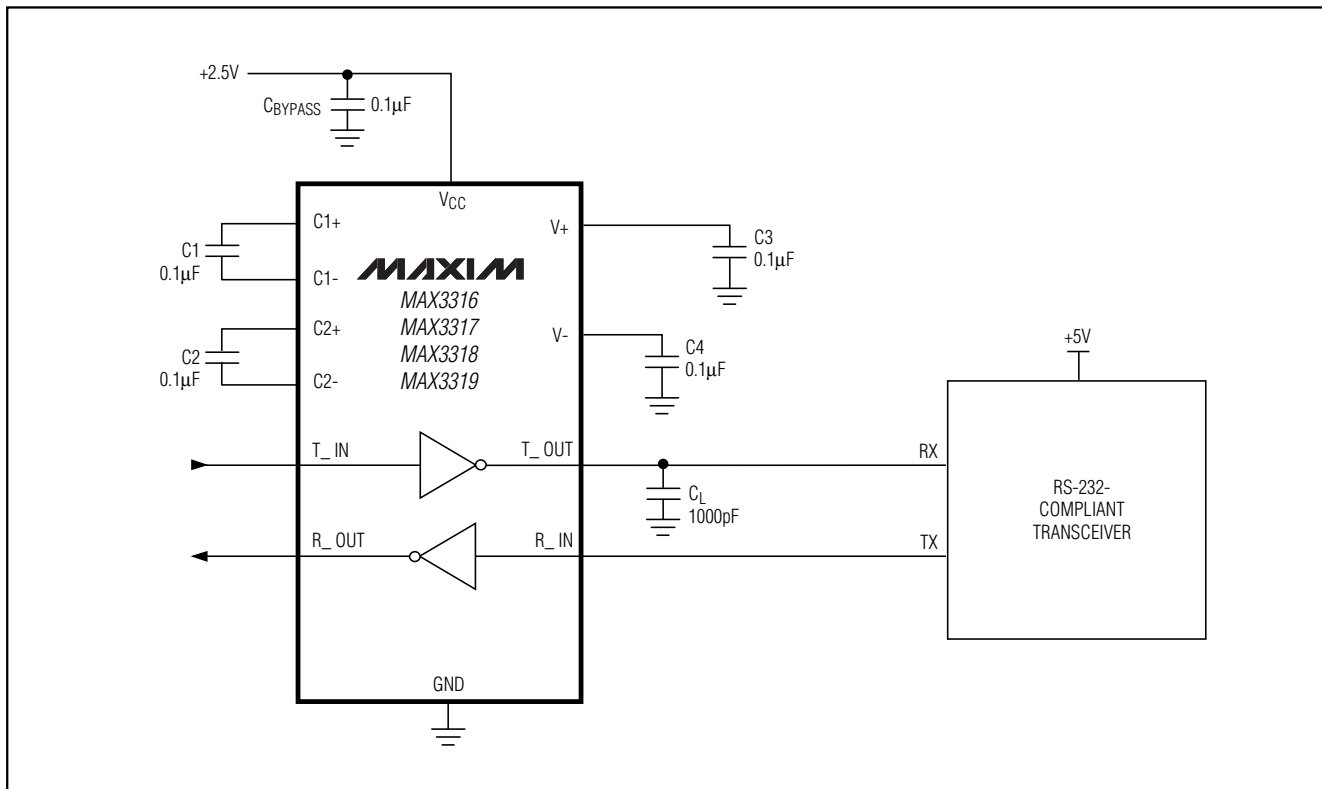

Figure 1a. RS-232-Compatibility Circuit

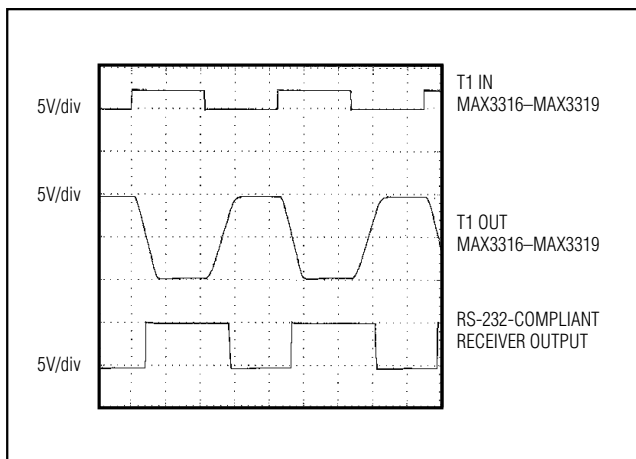

Figure 1b. MAX3316-MAX3319 Transmitter Output Compatibility with an RS-232 Receiver

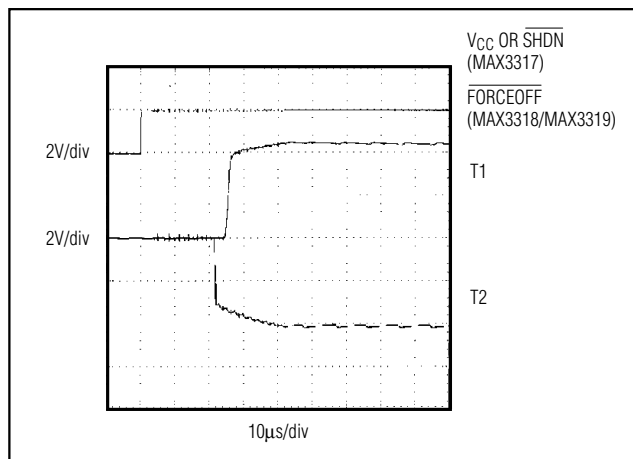

Figure 2. Transmitter Outputs when Exiting Shutdown or Powering Up

2.5V, 1 μ A, 460kbps, RS-232-Compatible Transceivers

When shut down, the device's charge pumps turn off, V+ is pulled to VCC, V- is pulled to ground, the transmitter outputs are high impedance, and READY is driven low. The time required to exit shutdown is typically 30 μ s (Figure 2).

By connecting FORCEON to $\overline{\text{INVALID}}$, the MAX3318/MAX3319 shut down when no valid receiver level is detected and wake up when a valid receiver level is detected.

A system with AutoShutdown Plus may need time to wake up. Figure 5 shows a circuit that forces the transmitters on for 100ms, allowing enough time for the other system to realize that the MAX3318/MAX3319 is awake. If the other system outputs valid RS-232 signal transitions within that time, the RS-232 ports on both systems remain enabled.

Connecting to the PC (MAX3318/MAX3319)

If direct software control is desired, use $\overline{\text{INVALID}}$ to indicate DTR or ring indicator (RI) signal. This can be used to connect a hand-held device to a PC. One example is using the hot sync function on a personal digital assistant (PDA). The transmitter and receiver signals ($\overline{\text{T_OUT}}$ and R_IN) are used for communication, while $\overline{\text{INVALID}}$ causes a change of state on RI. The change of state on RI will trigger an interrupt on the PC and allow communication to begin between the device and the PC. This eliminates the need for the PC to poll constantly the receiver or transmitter lines to determine if the device is connected.

Applications Information

RS-232-Compatible Operation

The MAX3316-MAX3319 do not meet EIA-232 requirements for transmitter output voltage levels. EIA-232 compliance specifies transmitter output voltage swings of $\pm 5\text{V}$ when loaded with 3k Ω and 2500pF.

The receiver inputs are fully EIA-232 compliant.

The MAX3316-MAX3319 will function properly with most modern RS-232 interfaces. This allows RS-232-compatible communication in low-voltage systems without the added expense of a voltage tripler or switched-mode power supply.

Capacitor Selection

The capacitor type used for C1-C4 is not critical for proper operation; polarized or nonpolarized capacitors can be used. The charge pump requires 0.1 μ F capacitors. Increasing the capacitor values (e.g., by a factor of

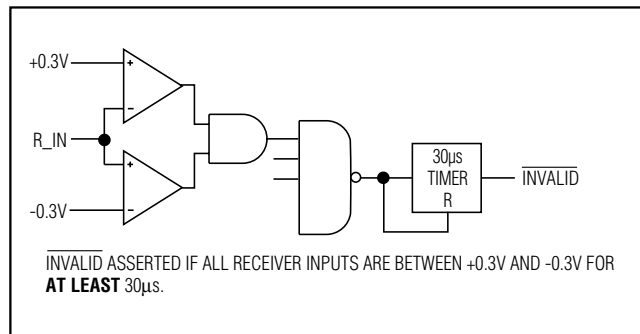

Figure 3a. $\overline{\text{INVALID}}$ Functional Diagram, $\overline{\text{INVALID}}$ Low



Figure 3b. $\overline{\text{INVALID}}$ Functional Diagram, $\overline{\text{INVALID}}$ High



Figure 4a. Receiver Positive/Negative Thresholds for $\overline{\text{INVALID}}$

2) reduces ripple on the transmitter outputs and slightly reduces power consumption. C2, C3, and C4 can be increased without changing C1's value. **However, do not increase C1 without also increasing the values of**

2.5V, 1 μ A, 460kbps, RS-232-Compatible Transceivers

MAX3316-MAX3319

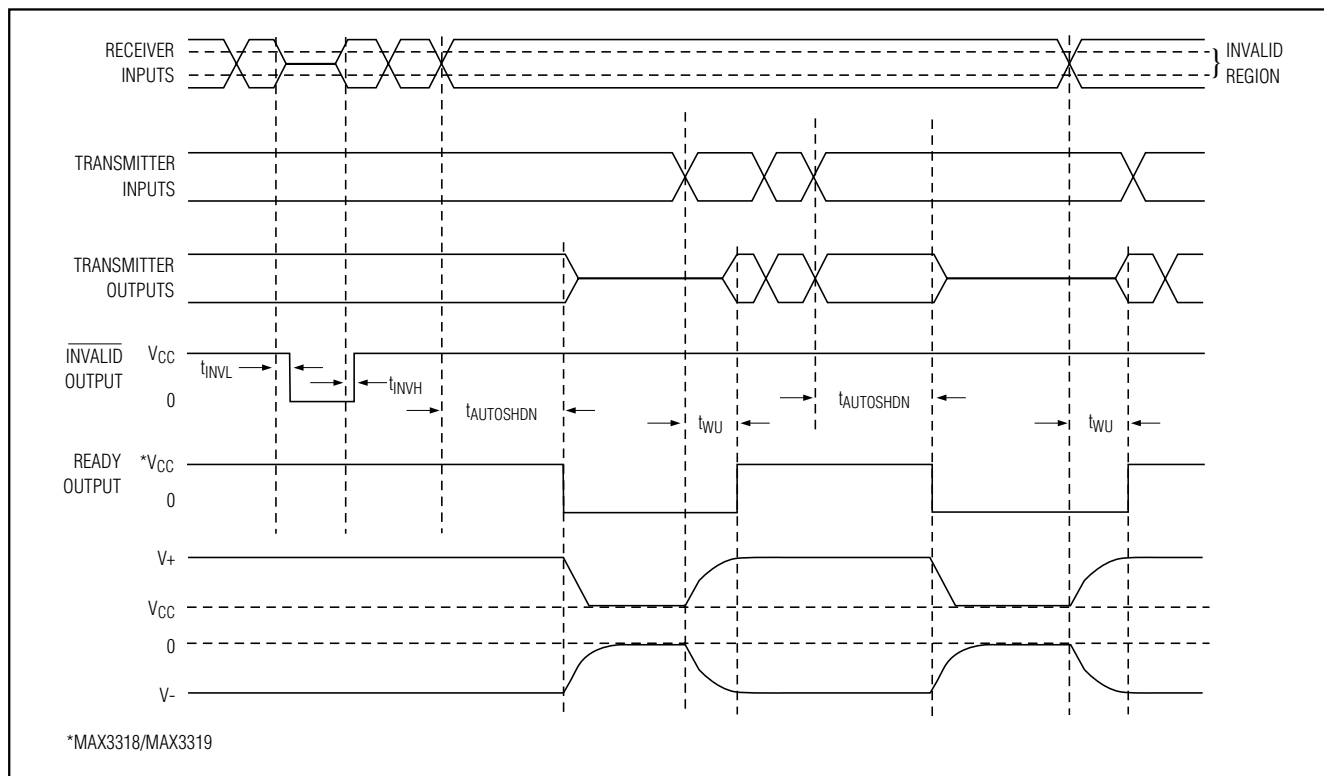

Figure 4b. AutoShutdown Plus, $\overline{\text{INVALID}}$, and READY Timing Diagram

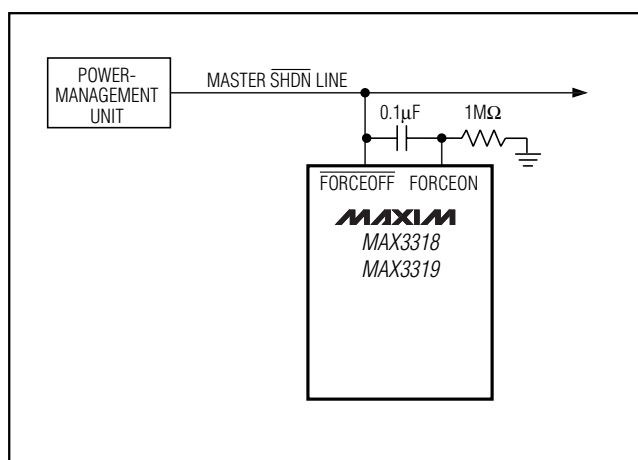

Figure 5. AutoShutdown Plus Initial Turn-On to Wake Up a Mouse or Another System

C2, C3, C4, and CBYPASS to maintain proper ratios (C1 to other capacitors).

When using the minimum-required capacitor values, make sure the capacitor value does not degrade excessively with temperature. If in doubt, use capacitors with a higher nominal value. The capacitor's equivalent series resistance (ESR), which usually rises at low temperatures, influences the amount of ripple on $V+$ and $V-$.

Power-Supply Decoupling

In most circumstances, a 0.1 μ F bypass capacitor is adequate. In applications that are sensitive to power-supply noise, decouple V_{CC} to ground with a capacitor of the same value as charge pump capacitor C1. Connect bypass capacitors as close to the IC as possible.

Transmitter Outputs when Exiting Shutdown

Figure 2 shows two transmitter outputs when exiting shutdown mode. As they become active, the two transmitter outputs are shown going to opposite RS-232-compatible levels (one transmitter input is high, the other is low). Each transmitter is loaded with 3k Ω in par-

2.5V, 1μA, 460kbps, RS-232-Compatible Transceivers

allel with 2500pF. The transmitter outputs display no ringing or undesirable transients as they come out of shutdown. Note that the transmitters are enabled only when the magnitude of V- exceeds approximately -3V.

High Data Rates

The MAX3316-MAX3319 maintain RS-232-compatible ±3.7V minimum transmitter output voltage even at high data rates. Figure 6 shows a transmitter loopback test circuit. Figure 7 shows a loopback test result at 230kbps. For Figure 7, all transmitters were driven simultaneously at 230kbps into EIA/TIA-562 loads in parallel with 1000pF.



Figure 6. Loopback Test Circuit



Figure 7. Loopback Test Result at 230kbps

Ordering Information (continued)

PART	TEMP. RANGE	PIN-PACKAGE
MAX3317 CUP	0°C to +70°C	20 TSSOP
MAX3317CAP	0°C to +70°C	20 SSOP
MAX3317EUP	-40°C to +85°C	20 TSSOP
MAX3317EAP	-40°C to +85°C	20 SSOP
MAX3318 CUP	0°C to +70°C	20 TSSOP
MAX3318CAP	0°C to +70°C	20 SSOP
MAX3318EUP	-40°C to +85°C	20 TSSOP
MAX3318EAP	-40°C to +85°C	20 SSOP
MAX3319 CAE	0°C to +70°C	16 SSOP
MAX3319EAE	-40°C to +85°C	16 SSOP

Chip Information

TRANSISTOR COUNT: 1130
PROCESS: CMOS

2.5V, 1 μ A, 460kbps, RS-232-Compatible Transceivers

Pin Configurations (continued)

MAX3316-MAX3319

TOP VIEW

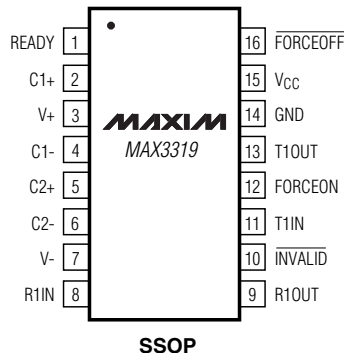
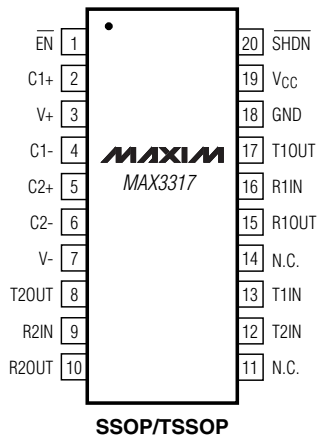

2.5V, 1μA, 460kbps, RS-232-Compatible Transceivers

Typical Application Circuits (continued)



*C3 CAN BE RETURNED TO EITHER V_{CC} OR GROUND.



CIRCUIT SHOWN IS FOR THE 16-PIN SSOP.

2.5V, 1µA, 460kbps, RS-232-Compatible Transceivers

Typical Application Circuits (continued)

MAX3316-MAX3319

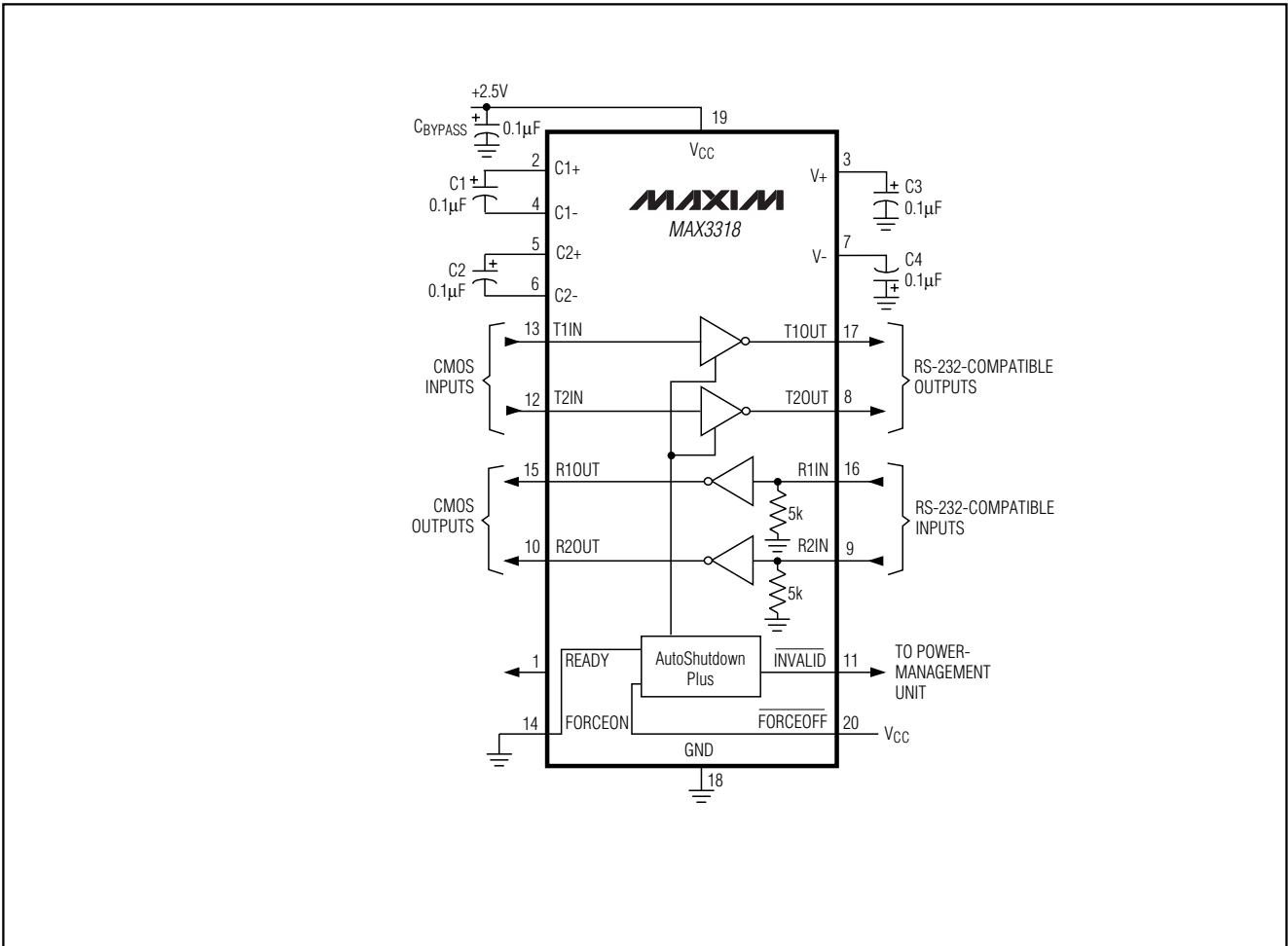

Maxim cannot assume responsibility for use of any circuitry other than circuitry entirely embodied in a Maxim product. No circuit patent licenses are implied. Maxim reserves the right to change the circuitry and specifications without notice at any time.

Maxim Integrated Products, 120 San Gabriel Drive, Sunnyvale, CA 94086 408-737-7600 _____ 15