

T-79-05-10

ORDERING INFORMATION

Device	Alternate	Temperature Range	Package
MC1741CD	—	0°C to +70°C	SO-8
MC1741CG	LM741CH, μ A741HC	0°C to +70°C	Metal Can
MC1741CP1	LM741CN, μ A741TC	0°C to +70°C	Plastic DIP
MC1741CU	—	0°C to +70°C	Ceramic DIP
MC1741G	—	-55°C to +125°C	Metal Can
MC1741U	—	-55°C to +125°C	Ceramic DIP

**MC1741
MC1741C**

2

INTERNALLY COMPENSATED, HIGH PERFORMANCE OPERATIONAL AMPLIFIERS

... designed for use as a summing amplifier, integrator, or amplifier with operating characteristics as a function of the external feedback components.

- No Frequency Compensation Required
- Short-Circuit Protection
- Offset Voltage Null Capability
- Wide Common-Mode and Differential Voltage Ranges
- Low-Power Consumption
- No Latch Up

OPERATIONAL AMPLIFIER SILICON MONOLITHIC INTEGRATED CIRCUIT

G SUFFIX METAL PACKAGE CASE 601-04

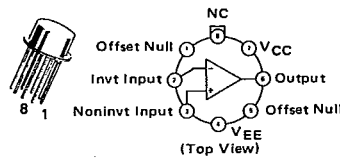

P1 SUFFIX PLASTIC PACKAGE CASE 628-05



D SUFFIX PLASTIC PACKAGE CASE 751-02 SO-8

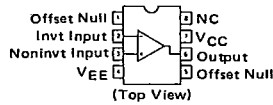

MAXIMUM RATINGS (TA = +25°C unless otherwise noted)

Rating	Symbol	MC1741C	MC1741	Unit
Power Supply Voltage	VCC VEE	+18 -18	+22 -22	Vdc
Input Differential Voltage	V _{ID}	±30		Volts
Input Common Mode Voltage (Note 1)	V _{ICM}	±15		Volts
Output Short Circuit Duration (Note 2)	t _S	Continuous		
Operating Ambient Temperature Range	T _A	0 to +70	-55 to +125	°C
Storage Temperature Range Metal and Ceramic Packages Plastic Packages	T _{stg}	-65 to +150 -55 to +125		°C

Note 1. For supply voltages less than +15 V, the absolute maximum input voltage is equal to the supply voltage.
Note 2. Supply voltage equal to or less than 15 V.

EQUIVALENT CIRCUIT SCHEMATIC

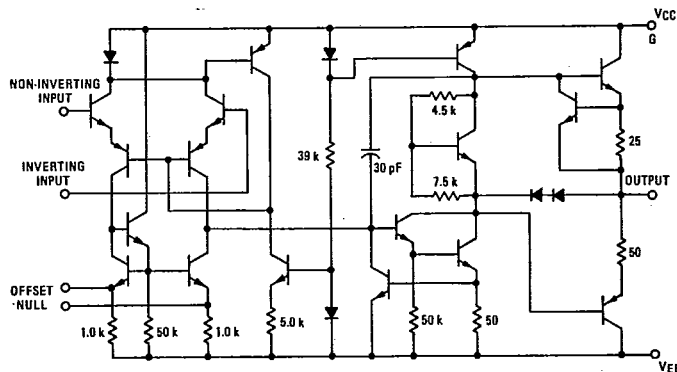

MC1741, MC1741C

T-79-05-10

ELECTRICAL CHARACTERISTICS (V_{CC} = +15 V, V_{EE} = -15 V, T_A = 25°C unless otherwise noted).

Characteristic	Symbol	MC1741			MC1741C			Unit
		Min	Typ	Max	Min	Typ	Max	
Input Offset Voltage (R _S ≤ 10 k)	V _{IO}	-	1.0	5.0	-	2.0	6.0	mV
Input Offset Current	I _{IO}	-	20	200	-	20	200	nA
Input Bias Current	I _{IB}	-	80	500	-	80	500	nA
Input Resistance	r _i	0.3	2.0	-	0.3	2.0	-	MΩ
Input Capacitance	C _i	-	1.4	-	-	1.4	-	pF
Offset Voltage Adjustment Range	V _{IOR}	-	±15	-	-	±15	-	mV
Common Mode Input Voltage Range	V _{ICR}	±12	±13	-	±12	±13	-	V
Large Signal Voltage Gain (V _O = ±10 V, R _L ≥ 2.0 k)	A _v	50	200	-	20	200	-	V/mV
Output Resistance	r _o	-	75	-	-	75	-	Ω
Common Mode Rejection Ratio (R _S ≤ 10 k)	CMRR	70	90	-	70	90	-	dB
Supply Voltage Rejection Ratio (R _S ≤ 10 k)	PSRR	-	30	150	-	30	150	μV/V
Output Voltage Swing (R _L ≥ 10 k, R _L ≥ 2 k)	V _O	±12 ±10	±14 ±13	-	±12 ±10	±14 ±13	-	V
Output Short-Circuit Current	I _{os}	-	20	-	-	20	-	mA
Supply Current	I _D	-	1.7	2.8	-	1.7	2.8	mA
Power Consumption	P _C	-	50	85	-	50	85	mW
Transient Response (Unity Gain - Non-Inverting) (V _i = 20 mV, R _L ≥ 2 k, C _L ≤ 100 pF) Rise Time (V _i = 20 mV, R _L ≥ 2 k, C _L ≤ 100 pF) Overshoot (V _i = 10 V, R _L ≥ 2 k, C _L ≤ 100 pF) Slew Rate	t _{RLH} os SR	-	0.3 15 0.5	- - -	- - -	0.3 15 0.5	- - -	μs % V/μs

ELECTRICAL CHARACTERISTICS (V_{CC} = +15 V, V_{EE} = -15 V, T_A = T_{low} to T_{high} unless otherwise noted).

Characteristic	Symbol	MC1741			MC1741C			Unit
		Min	Typ	Max	Min	Typ	Max	
Input Offset Voltage (R _S ≤ 10 kΩ)	V _{IO}	-	1.0	6.0	-	-	7.5	mV
Input Offset Current (T _A = 125°C) (T _A = -55°C) (T _A = 0°C to +70°C)	I _{IO}	-	7.0 85 -	200 500 -	-	-	- 300	nA
Input Bias Current (T _A = 125°C) (T _A = -55°C) (T _A = 0°C to +70°C)	I _{IB}	-	30 300 -	500 1500 -	-	-	- 800	nA
Common Mode Input Voltage Range	V _{ICR}	±12	±13	-	-	-	-	V
Common Mode Rejection Ratio (R _S ≤ 10 k)	CMRR	70	90	-	-	-	-	dB
Supply Voltage Rejection Ratio (R _S ≤ 10 k)	PSRR	-	30	150	-	-	-	μV/V
Output Voltage Swing (R _L ≥ 10 k, R _L ≥ 2 k)	V _O	±12 ±10	±14 ±13	-	±10	±13	-	V
Large Signal Voltage Gain (R _L ≥ 2 k, V _{out} = ±10 V)	A _v	25	-	-	15	-	-	V/mV
Supply Currents (T _A = 125°C) (T _A = -55°C)	I _D	-	1.5 2.0	2.5 3.3	-	-	-	mA
Power Consumption (T _A = +125°C) (T _A = -55°C)	P _C	-	45 60	75 100	-	-	-	mW

*T_{high} = 125°C for MC1741 and 70°C for MC1741C
T_{low} = -55°C for MC1741 and 0°C for MC1741C

T-79-05-10

MC1741, MC1741C

2

FIGURE 1 - BURST NOISE versus SOURCE RESISTANCE

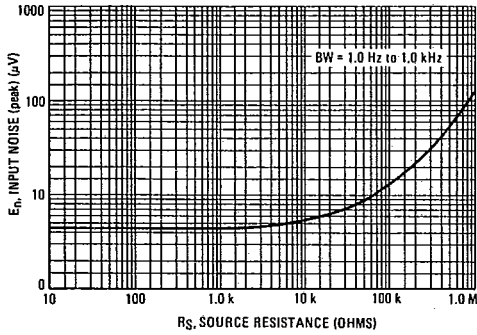

FIGURE 2 - RMS NOISE versus SOURCE RESISTANCE

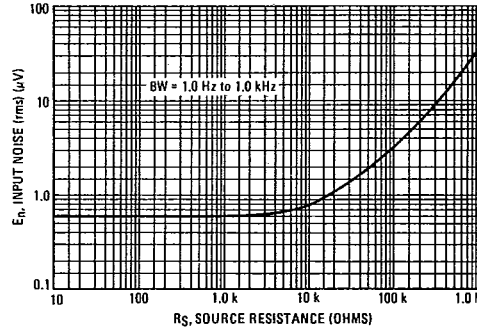

FIGURE 3 - OUTPUT NOISE versus SOURCE RESISTANCE

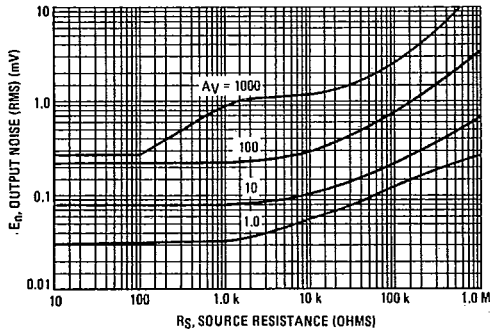

FIGURE 4 - SPECTRAL NOISE DENSITY

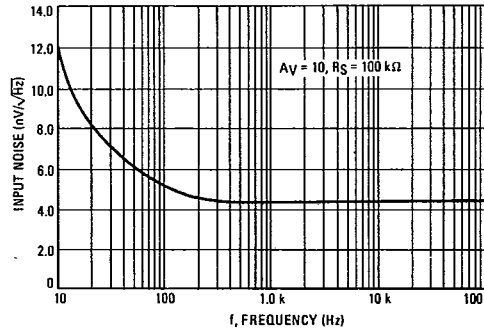
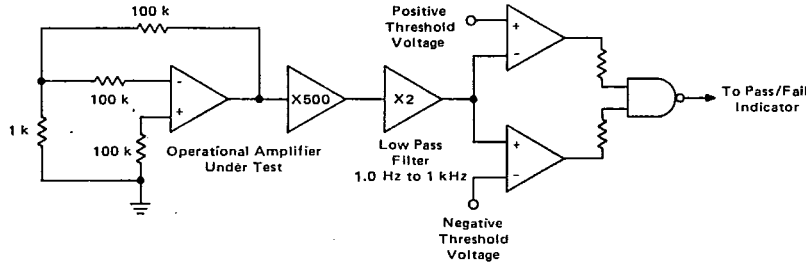

FIGURE 5 - BURST NOISE TEST CIRCUIT



Unlike conventional peak reading or RMS meters, this system was especially designed to provide the quick response time essential to burst (popcorn) noise testing.

The test time employed is 10 seconds and the 20 μ V peak limit refers to the operational amplifier input thus eliminating errors in the closed-loop gain factor of the operational amplifier under test.

MC1741, MC1741C

T-79-05-10

TYPICAL CHARACTERISTICS

($V_{CC} = +15$ Vdc, $V_{EE} = -15$ Vdc, $T_A = +25^\circ\text{C}$ unless otherwise noted)

FIGURE 6 - POWER BANDWIDTH
(LARGE SIGNAL SWING versus FREQUENCY)

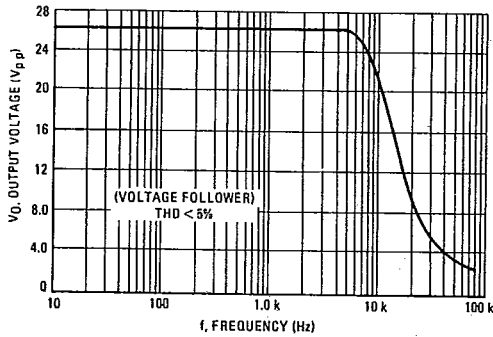

FIGURE 7 - OPEN LOOP FREQUENCY RESPONSE

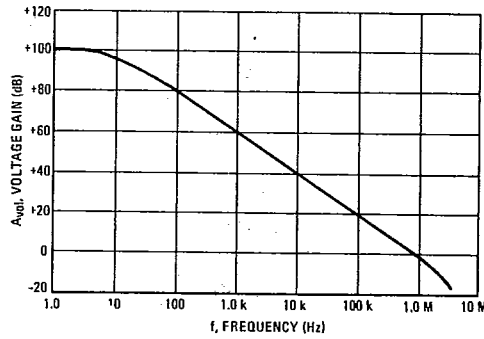

FIGURE 8 - POSITIVE OUTPUT VOLTAGE SWING
versus LOAD RESISTANCE

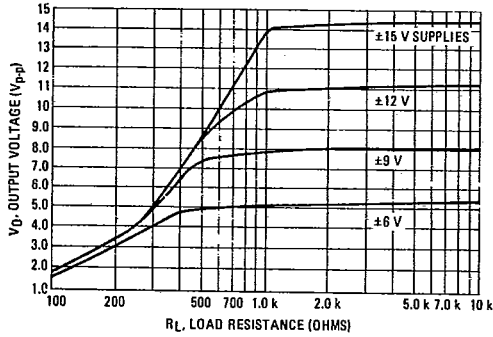

FIGURE 9 - NEGATIVE OUTPUT VOLTAGE SWING
versus LOAD RESISTANCE

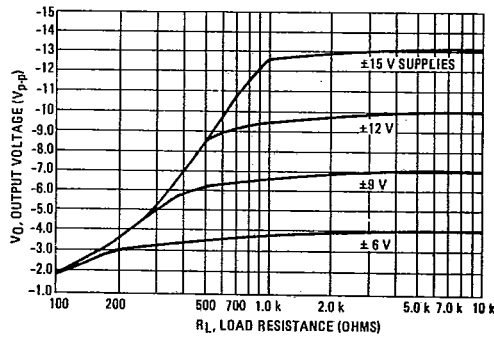

FIGURE 10 - OUTPUT VOLTAGE SWING versus
LOAD RESISTANCE (Single Supply Operation)

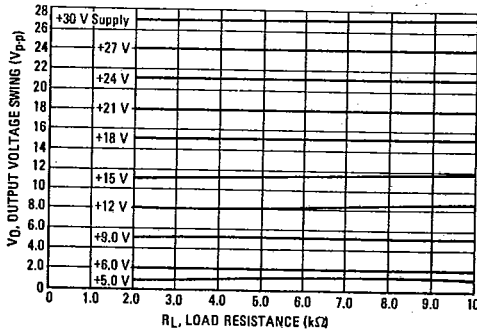
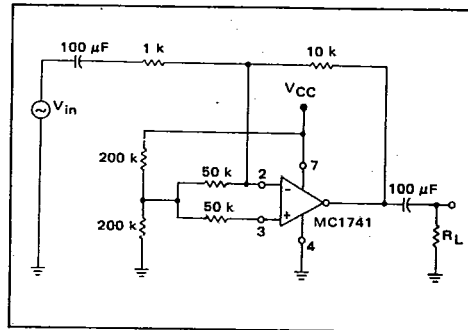

FIGURE 11 - SINGLE SUPPLY INVERTING AMPLIFIER



MC1741, MC1741C

T-79-05-10

2

FIGURE 12 — NONINVERTING PULSE RESPONSE

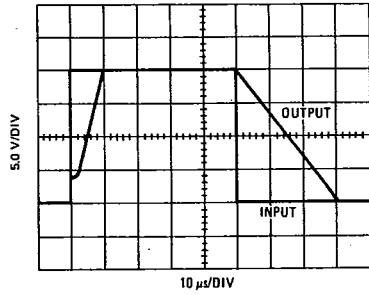

FIGURE 13 — TRANSIENT RESPONSE TEST CIRCUIT

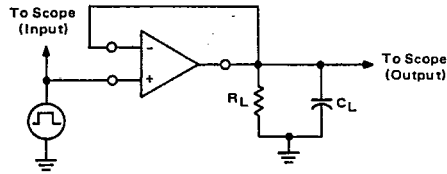

FIGURE 14 — OPEN LOOP VOLTAGE GAIN versus SUPPLY VOLTAGE

