



ON Semiconductor®

2N7000 / 2N7002 / NDS7002A

N-Channel Enhancement Mode Field Effect Transistor

Features

- High Density Cell Design for Low $R_{DS(ON)}$
- Voltage Controlled Small Signal Switch
- Rugged and Reliable
- High Saturation Current Capability

Description

These N-channel enhancement mode field effect transistors are produced using ON Semiconductor's proprietary, high cell density, DMOS technology. These products have been designed to minimize on-state resistance while providing rugged, reliable, and fast switching performance. They can be used in most applications requiring up to 400 mA DC and can deliver pulsed currents up to 2 A. These products are particularly suited for low-voltage, low-current applications, such as small servo motor control, power MOSFET gate drivers, and other switching applications.

Datasheet.Directory

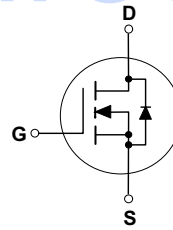
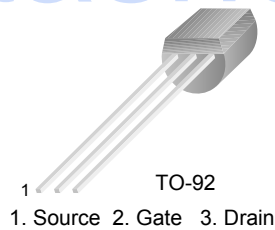

Ordering Information

Part Number	Marking	Package	Packing Method	Min Order Qty / Immediate Pack Qty
2N7000	2N7000	TO-92 3L	Bulk	10000 / 1000
2N7000-D74Z	2N7000	TO-92 3L	Ammo	2000 / 2000
2N7000-D75Z	2N7000	TO-92 3L	Tape and Reel	2000 / 2000
2N7000-D26Z	2N7000	TO-92 3L	Tape and Reel	2000 / 2000
2N7002	702	SOT-23 3L	Tape and Reel	3000 / 3000
NDS7002A	712	SOT-23 3L	Tape and Reel	3000 / 3000

2N7000 / 2N7002 / NDS7002A — N-Channel Enhancement Mode Field Effect Transistor

Absolute Maximum Ratings

Stresses exceeding the absolute maximum ratings may damage the device. The device may not function or be operable above the recommended operating conditions and stressing the parts to these levels is not recommended. In addition, extended exposure to stresses above the recommended operating conditions may affect device reliability. The absolute maximum ratings are stress ratings only. Values are at $T_C = 25^\circ\text{C}$ unless otherwise noted.

Symbol	Parameter	Value			Unit
		2N7000	2N7002	NDS7002A	
V_{DSS}	Drain-to-Source Voltage	60			V
V_{DGR}	Drain-Gate Voltage ($R_{GS} \leq 1\text{ M}\Omega$)	60			V
V_{GSS}	Gate-Source Voltage - Continuous	± 20			V
	Gate-Source Voltage - Non Repetitive ($t_p < 50\ \mu\text{s}$)	± 40			
I_D	Maximum Drain Current - Continuous	200	115	280	mA
	Maximum Drain Current - Pulsed	500	800	1500	
P_D	Maximum Power Dissipation Derated above 25°C	400	200	300	mW
		3.2	1.6	2.4	mW/ $^\circ\text{C}$
T_J, T_{STG}	Operating and Storage Temperature Range	-55 to 150		-65 to 150	$^\circ\text{C}$
T_L	Maximum Lead Temperature for Soldering Purposes, 1/16-inch from Case for 10 Seconds	300			$^\circ\text{C}$

Thermal Characteristics

Values are at $T_C = 25^\circ\text{C}$ unless otherwise noted.

Symbol	Parameter	Value			Unit
		2N7000	2N7002	NDS7002A	
$R_{\theta JA}$	Thermal Resistance, Junction to Ambient	312.5	625	417	$^\circ\text{C}/\text{W}$

Electrical Characteristics

Values are at $T_C = 25^\circ\text{C}$ unless otherwise noted.

Symbol	Parameter	Conditions	Type	Min.	Typ.	Max.	Unit
Off Characteristics							
BV_{DSS}	Drain-Source Breakdown Voltage	$V_{GS} = 0\text{ V}, I_D = 10\ \mu\text{A}$	All	60			V
I_{DSS}	Zero Gate Voltage Drain Current	$V_{DS} = 48\text{ V}, V_{GS} = 0\text{ V}$	2N7000			1	μA
		$V_{DS} = 48\text{ V}, V_{GS} = 0\text{ V}, T_C = 125^\circ\text{C}$				1	mA
		$V_{DS} = 60\text{ V}, V_{GS} = 0\text{ V}$	2N7002 NDS7002A			1	μA
		$V_{DS} = 60\text{ V}, V_{GS} = 0\text{ V}, T_C = 125^\circ\text{C}$				0.5	mA
I_{GSSF}	Gate - Body Leakage, Forward	$V_{GS} = 15\text{ V}, V_{DS} = 0\text{ V}$	2N7000			10	nA
		$V_{GS} = 20\text{ V}, V_{DS} = 0\text{ V}$	2N7002 NDS7002A			100	nA
I_{GSSR}	Gate - Body Leakage, Reverse	$V_{GS} = -15\text{ V}, V_{DS} = 0\text{ V}$	2N7000			-10	nA
		$V_{GS} = -20\text{ V}, V_{DS} = 0\text{ V}$	2N7002 NDS7002A			-100	nA

Electrical Characteristics (Continued)

Symbol	Parameter	Conditions	Type	Min.	Typ.	Max.	Unit
On Characteristics							
$V_{GS(th)}$	Gate Threshold Voltage	$V_{DS} = V_{GS}, I_D = 1 \text{ mA}$	2N7000	0.8	2.1	3	V
		$V_{DS} = V_{GS}, I_D = 250 \mu\text{A}$	2N7002 NDS7002A	1	2.1	2.5	
$R_{DS(ON)}$	Static Drain-Source On-Resistance	$V_{GS} = 10 \text{ V}, I_D = 500 \text{ mA}$	2N7000		1.2	5	Ω
		$V_{GS} = 10 \text{ V}, I_D = 500 \text{ mA}, T_C = 125^\circ\text{C}$			1.9	9	
		$V_{GS} = 4.5 \text{ V}, I_D = 75 \text{ mA}$			1.8	5.3	
		$V_{GS} = 10 \text{ V}, I_D = 500 \text{ mA}$	2N7002		1.2	7.5	
		$V_{GS} = 10 \text{ V}, I_D = 500 \text{ mA}, T_C = 100^\circ\text{C}$			1.7	13.5	
		$V_{GS} = 5 \text{ V}, I_D = 50 \text{ mA}$			1.7	7.5	
		$V_{GS} = 5 \text{ V}, I_D = 50 \text{ mA}, T_C = 100^\circ\text{C}$			2.4	13.5	
		$V_{GS} = 10 \text{ V}, I_D = 500 \text{ mA}$	NDS7002A		1.2	2	
		$V_{GS} = 10 \text{ V}, I_D = 500 \text{ mA}, T_C = 125^\circ\text{C}$			2	3.5	
		$V_{GS} = 5 \text{ V}, I_D = 50 \text{ mA}$			1.7	3	
		$V_{GS} = 5 \text{ V}, I_D = 50 \text{ mA}, T_C = 125^\circ\text{C}$			2.8	5	
		$V_{DS(ON)}$	Drain-Source On-Voltage	$V_{GS} = 10 \text{ V}, I_D = 500 \text{ mA}$	2N7000		
$V_{GS} = 4.5 \text{ V}, I_D = 75 \text{ mA}$				0.14		0.4	
$V_{GS} = 10 \text{ V}, I_D = 500 \text{ mA}$	2N7002				0.6	3.75	
$V_{GS} = 5.0 \text{ V}, I_D = 50 \text{ mA}$					0.09	1.5	
$V_{GS} = 10 \text{ V}, I_D = 500 \text{ mA}$	NDS7002A				0.6	1	
$V_{GS} = 5.0 \text{ V}, I_D = 50 \text{ mA}$					0.09	0.15	
$I_{D(ON)}$	On-State Drain Current	$V_{GS} = 4.5 \text{ V}, V_{DS} = 10 \text{ V}$	2N7000	75	600		mA
		$V_{GS} = 10 \text{ V}, V_{DS} \geq 2 V_{DS(on)}$	2N7002	500	2700		
		$V_{GS} = 10 \text{ V}, V_{DS} \geq 2 V_{DS(on)}$	NDS7002A	500	2700		
g_{FS}	Forward Transconductance	$V_{DS} = 10 \text{ V}, I_D = 200 \text{ mA}$	2N7000	100	320		mS
		$V_{DS} \geq 2V_{DS(ON)}, I_D = 200 \text{ mA}$	2N7002	80	320		
		$V_{DS} \geq 2V_{DS(ON)}, I_D = 200 \text{ mA}$	NDS7002A	80	320		

Electrical Characteristics (Continued)

Symbol	Parameter	Conditions	Type	Min.	Typ.	Max.	Unit
Dynamic Characteristics							
C_{iss}	Input Capacitance	$V_{DS} = 25\text{ V}, V_{GS} = 0\text{ V},$ $f = 1.0\text{ MHz}$	All		20	50	pF
C_{oss}	Output Capacitance		All		11	25	
C_{rss}	Reverse Transfer Capacitance		All		4	5	
t_{on}	Turn-On Time	$V_{DD} = 15\text{ V}, R_L = 25\ \Omega,$ $I_D = 500\text{ mA}, V_{GS} = 10\text{ V},$ $R_{GEN} = 25\ \Omega$	2N7000			10	ns
		$V_{DD} = 30\text{ V}, R_L = 150\ \Omega,$ $I_D = 200\text{ mA}, V_{GS} = 10\text{ V},$ $R_{GEN} = 25\ \Omega$	2N7002 NDS7002A			20	
t_{off}	Turn-Off Time	$V_{DD} = 15\text{ V}, R_L = 25\ \Omega,$ $I_D = 500\text{ mA}, V_{GS} = 10\text{ V},$ $R_{GEN} = 25\ \Omega$	2N7000			10	ns
		$V_{DD} = 30\text{ V}, R_L = 150\ \Omega,$ $I_D = 200\text{ mA}, V_{GS} = 10\text{ V},$ $R_{GEN} = 25\ \Omega$	2N7002 NDS7002A			20	
Drain-Source Diode Characteristics and Maximum Ratings							
I_S	Maximum Continuous Drain-Source Diode Forward Current		2N7002			115	mA
			NDS7002A			280	
I_{SM}	Maximum Pulsed Drain-Source Diode Forward Current		2N7002			0.8	A
			NDS7002A			1.5	
V_{SD}	Drain-Source Diode Forward Voltage	$V_{GS} = 0\text{ V},$ $I_S = 115\text{ mA}^{(1)}$	2N7002		0.88	1.5	V
		$V_{GS} = 0\text{ V},$ $I_S = 400\text{ mA}^{(1)}$	NDS7002A		0.88	1.2	

Note:

1. Pulse test : Pulse Width $\leq 300\ \mu\text{s}$, Duty Cycle $\leq 2\ \%$.

Typical Performance Characteristics

2N7000 / 2N7002 / NDS7002A

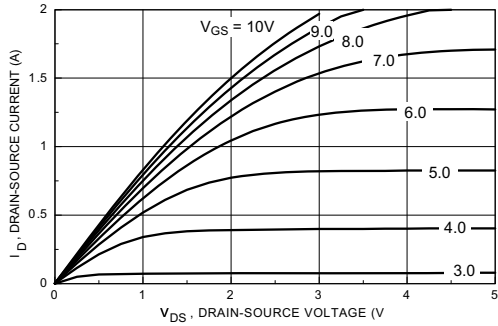

Figure 1. On-Region Characteristics

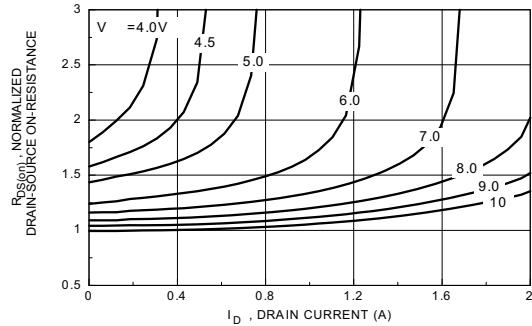

Figure 2. On-Resistance Variation with Gate Voltage and Drain Current

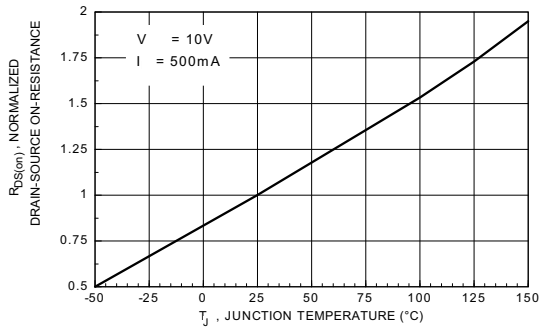

Figure 3. On-Resistance Variation with Temperature

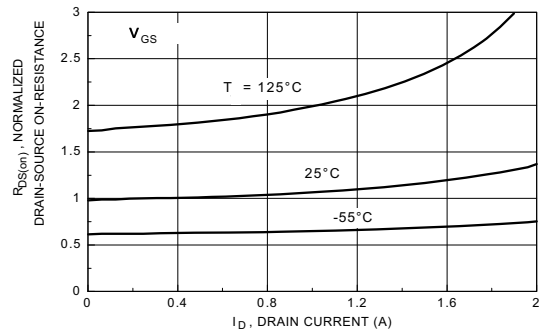

Figure 4. On-Resistance Variation with Drain Current and Temperature

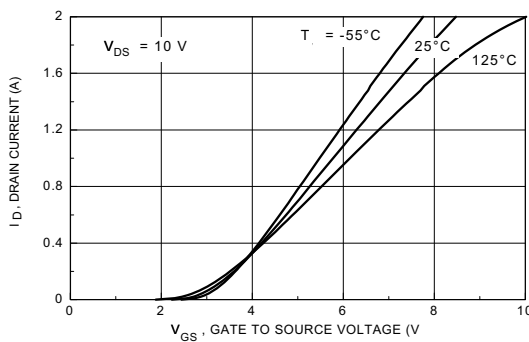

Figure 5. Transfer Characteristics

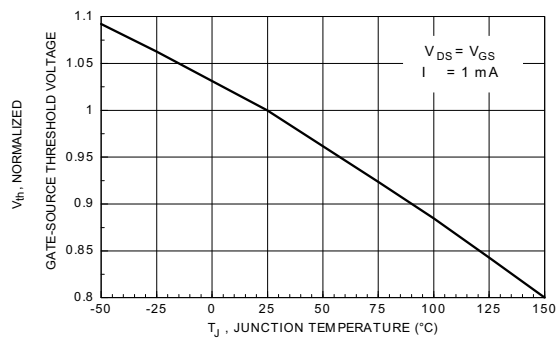

Figure 6. Gate Threshold Variation with Temperature

Typical Performance Characteristics (Continued)

2N7000 / 2N7002 / NDS7002A

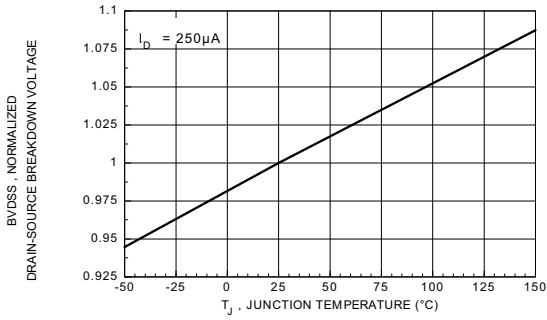

Figure 7. Breakdown Voltage Variation with Temperature

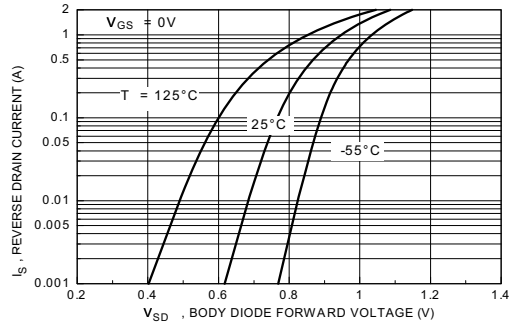

Figure 8. Body Diode Forward Voltage Variation with Temperature

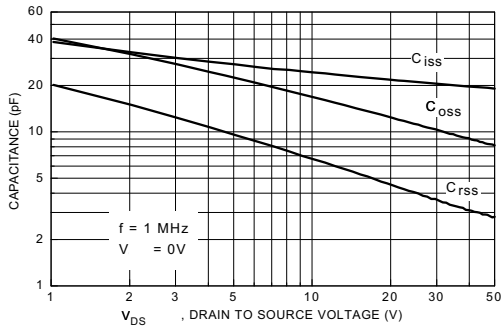

Figure 9. Capacitance Characteristics

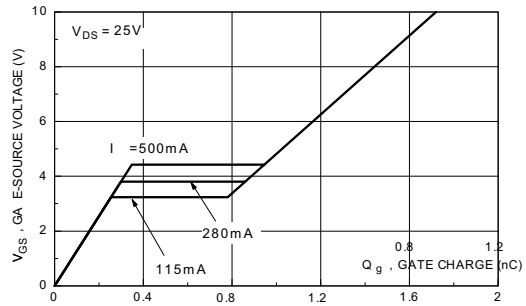

Figure 10. Gate Charge Characteristics

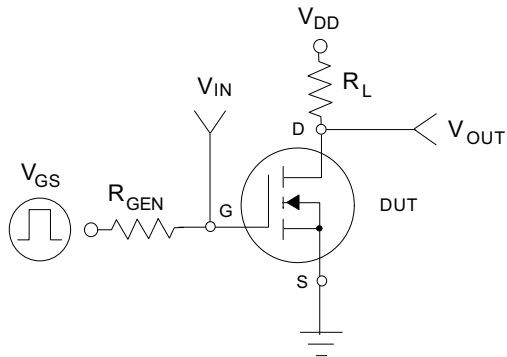

Figure 11. Switching Test Circuit

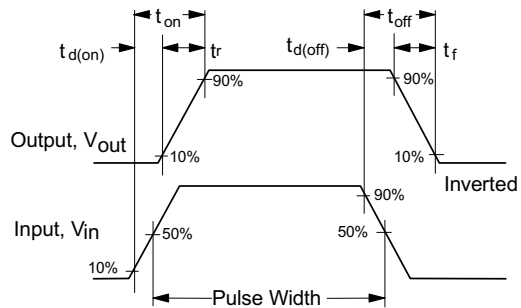

Figure 12. Switching Waveforms

Typical Performance Characteristics (Continued)

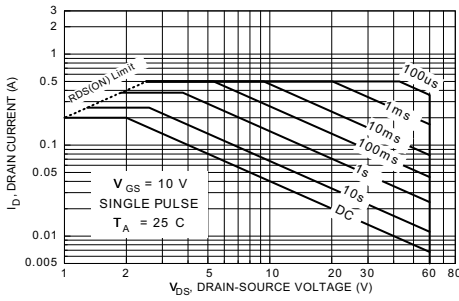

Figure 13. 2N7000 Maximum Safe Operating Area

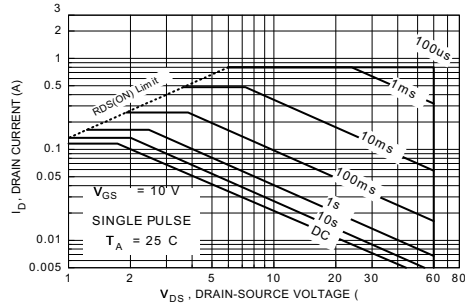

Figure 14. 2N7002 Maximum Safe Operating Area

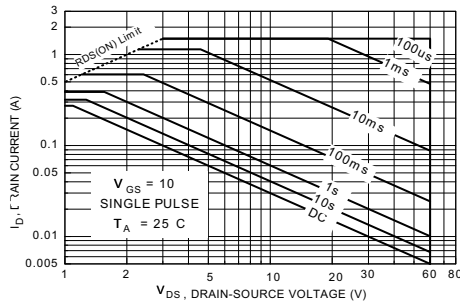

Figure 15. NDS7000A Maximum Safe Operating Area

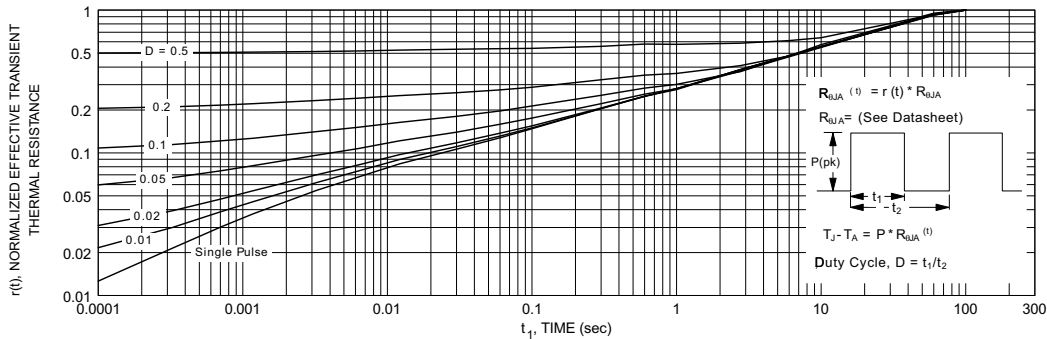

Figure 16. TO-92, 2N7000 Transient Thermal Response Curve

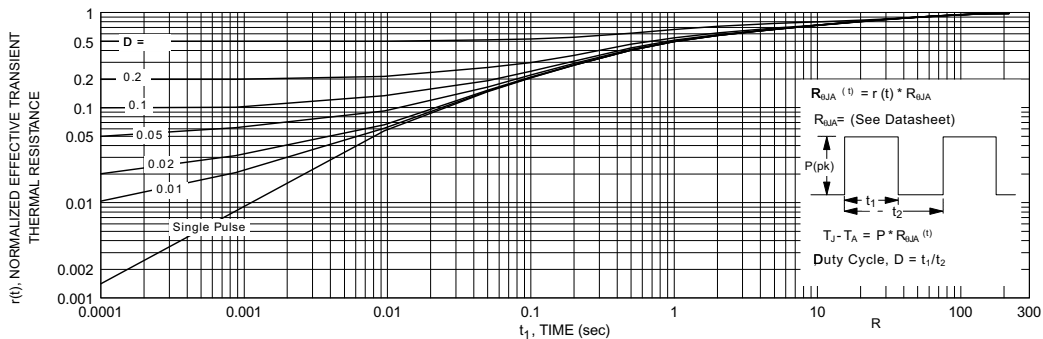

Figure 17. SOT-23, 2N7002 / NDS7002A Transient Thermal Response Curve

ON Semiconductor and  are trademarks of Semiconductor Components Industries, LLC dba ON Semiconductor or its subsidiaries in the United States and/or other countries. ON Semiconductor owns the rights to a number of patents, trademarks, copyrights, trade secrets, and other intellectual property. A listing of ON Semiconductor's product/patent coverage may be accessed at www.onsemi.com/site/pdf/Patent-Marking.pdf. ON Semiconductor reserves the right to make changes without further notice to any products herein. ON Semiconductor makes no warranty, representation or guarantee regarding the suitability of its products for any particular purpose, nor does ON Semiconductor assume any liability arising out of the application or use of any product or circuit, and specifically disclaims any and all liability, including without limitation special, consequential or incidental damages. Buyer is responsible for its products and applications using ON Semiconductor products, including compliance with all laws, regulations and safety requirements or standards, regardless of any support or applications information provided by ON Semiconductor. "Typical" parameters which may be provided in ON Semiconductor data sheets and/or specifications can and do vary in different applications and actual performance may vary over time. All operating parameters, including "Typicals" must be validated for each customer application by customer's technical experts. ON Semiconductor does not convey any license under its patent rights nor the rights of others. ON Semiconductor products are not designed, intended, or authorized for use as a critical component in life support systems or any FDA Class 3 medical devices or medical devices with a same or similar classification in a foreign jurisdiction or any devices intended for implantation in the human body. Should Buyer purchase or use ON Semiconductor products for any such unintended or unauthorized application, Buyer shall indemnify and hold ON Semiconductor and its officers, employees, subsidiaries, affiliates, and distributors harmless against all claims, costs, damages, and expenses, and reasonable attorney fees arising out of, directly or indirectly, any claim of personal injury or death associated with such unintended or unauthorized use, even if such claim alleges that ON Semiconductor was negligent regarding the design or manufacture of the part. ON Semiconductor is an Equal Opportunity/Affirmative Action Employer. This literature is subject to all applicable copyright laws and is not for resale in any manner.

PUBLICATION ORDERING INFORMATION

LITERATURE FULFILLMENT:

Literature Distribution Center for ON Semiconductor
19521 E. 32nd Pkwy, Aurora, Colorado 80011 USA
Phone: 303-675-2175 or 800-344-3860 Toll Free USA/Canada
Fax: 303-675-2176 or 800-344-3867 Toll Free USA/Canada
Email: orderlit@onsemi.com

N. American Technical Support: 800-282-9855 Toll Free
USA/Canada
Europe, Middle East and Africa Technical Support:
Phone: 421 33 790 2910
Japan Customer Focus Center
Phone: 81-3-5817-1050

ON Semiconductor Website: www.onsemi.com
Order Literature: <http://www.onsemi.com/orderlit>
For additional information, please contact your local
Sales Representative