

P4KE-HF Series

Breakdown Voltage: 6.8 to 600 Volts

Peak Pulse Power: 400 Watts

RoHS Device

Halogen Free



Features

- Glass passivated chip.
- 400W peak pulse power capability with a 10/1000 μ s waveform, repetitive rate (duty cycle):0.01%
- Low leakage.
- Uni and Bidirectional unit.
- Excellent clamping capability.
- Very fast response time.
- UL recognized file # E349157  Range: P4KE6.8(C)A thru. P4KE33(C)A

Mechanical Data

- Case: Molded plastic DO-41.
- Epoxy: UL 94V-0 rate flame retardant.
- Lead: Solderable per MIL-STD-202, method 208 guaranteed.
- Polarity: Color band denotes cathode end except Bipolar.
- Mounting position: Any.
- Weight: 0.321 gram (approx.)

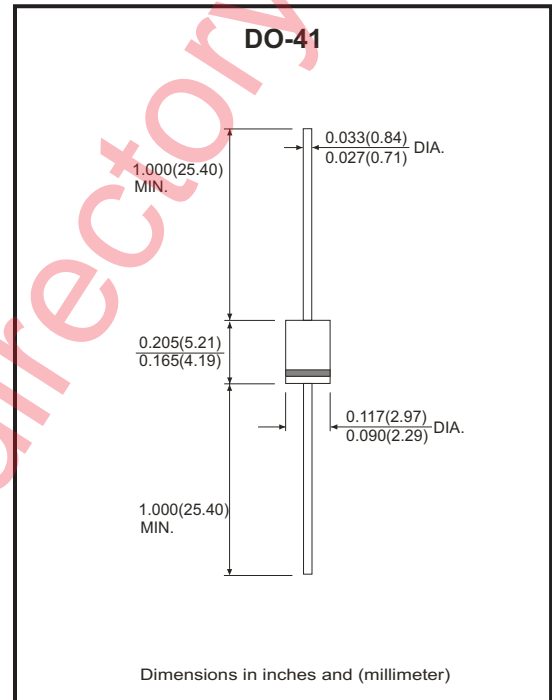

Maximum Ratings (TA=25°C unless otherwise noted)

Parameter	Symbol	Value	Unit
Peak power dissipation with a 10/1000 μ s waveform (Note 1)	PPP	400	W
Peak pulse current with a 10/1000 μ s waveform (Note 1)	IPP	See Next Table	A
Power dissipation on infinite heatsink at TL=75°C	Pd	1.0	W
Peak forward surge current, 8.3ms single half sine-wave unidirectional only (Note 2)	IFSM	40	A
Maximum instantaneous forward voltage at 25 A for unidirectional only (Note 3)	VF	3.5/5.0	V
Operating junction and storage temperature range	TJ, TSTG	-55 to +150	°C

NTOES:

(1) Non-repetitive current pulse per fig.5 and derated above TA=25°C per fig.1

(2) Measured on 8.3ms single half sine-wave or equivalent square wave, duty cycle=4 pulses per minute maximum

(3) VF<3.5V for devices of VBR<200V and VF<5.0V for devices of VBR>201V

Company reserves the right to improve product design , functions and reliability without notice.

REV:B

Rating and Characteristic Curves (P4KE-HF Series)

Fig.1 - Pulse Derating Curve

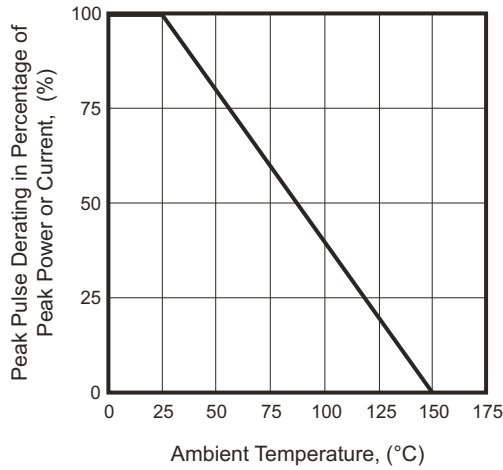

Fig.2 - Maximum Non-Repetitive Surge Current

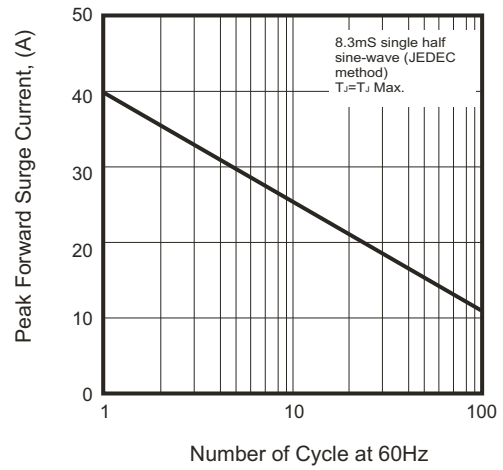

Fig.3 - Steady State Power Derating Curve

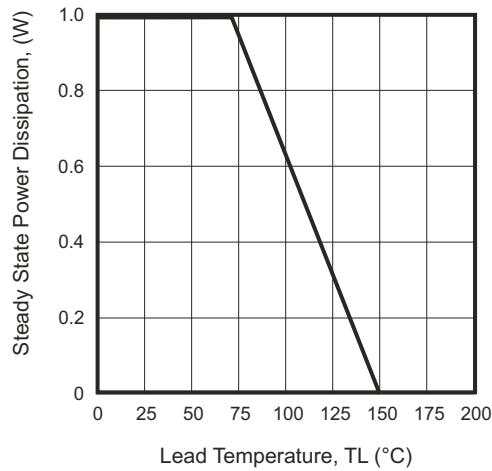

Fig.4 - Peak Pulse Power Rating Curve

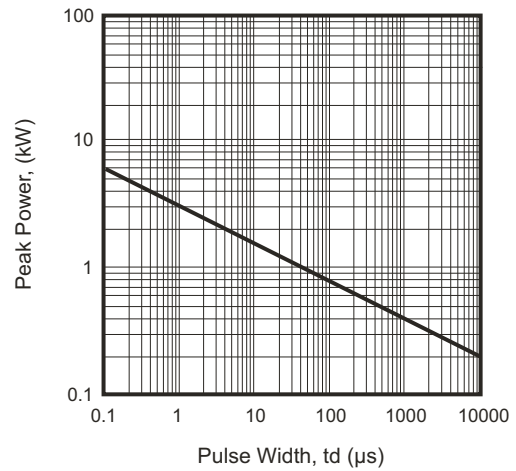

Fig.5 - Pulse Waveform

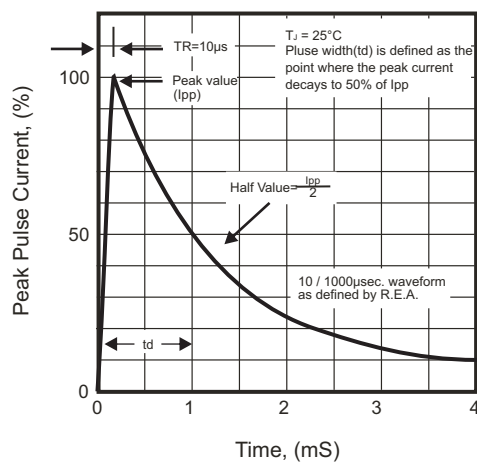
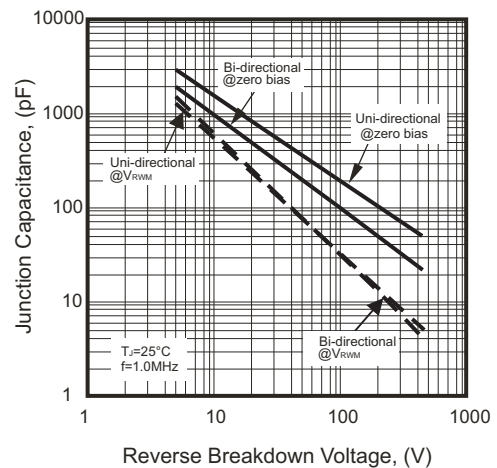

Fig.6 - Typical Junction Capacitance



Company reserves the right to improve product design, functions and reliability without notice.

REV:B

400W Transient Voltage Suppressor

Electrical Characteristics (P4KE-HF Series)

Part No.	Breakdown voltage VBR @ IT			Maximum Reverse Leakage @VRWM IR (uA)	Working Peak Reverse Voltage VRWM (V)	Maximum Reverse Surge Current IPP (A)	Maximum Clamping Voltage @IPP Vc (V)	Marking Code	
	Min. (V)	Max. (V)	IT (mA)					UNI	BI
P4KE6.8(C)A-HF	6.46	7.14	10	1000	5.8	38.10	10.5	P4KE6.8A	P4KE6.8CA
P4KE7.5(C)A-HF	7.13	7.88	10	500	6.4	35.40	11.3	P4KE7.5A	P4KE7.5CA
P4KE8.2(C)A-HF	7.79	8.61	10	200	7.0	33.06	12.1	P4KE8.2A	P4KE8.2CA
P4KE9.1(C)A-HF	8.65	9.56	1	50	7.8	29.85	13.4	P4KE9.1A	P4KE9.1CA
P4KE10(C)A-HF	9.50	10.50	1	10	8.6	27.59	14.5	P4KE10A	P4KE10CA
P4KE11(C)A-HF	10.45	11.55	1	5.0	9.4	25.64	15.6	P4KE11A	P4KE11CA
P4KE12(C)A-HF	11.40	12.60	1	5.0	10.2	23.95	16.7	P4KE12A	P4KE12CA
P4KE13(C)A-HF	12.35	13.65	1	1	11.1	21.98	18.2	P4KE13A	P4KE13CA
P4KE15(C)A-HF	14.25	15.75	1	1	12.8	18.87	21.2	P4KE15A	P4KE15CA
P4KE16(C)A-HF	15.20	16.80	1	1	13.6	17.78	22.5	P4KE16A	P4KE16CA
P4KE18(C)A-HF	17.10	18.90	1	1	15.3	15.87	25.2	P4KE18A	P4KE18CA
P4KE20(C)A-HF	19.00	21.00	1	1	17.1	14.44	27.7	P4KE20A	P4KE20CA
P4KE22(C)A-HF	20.90	23.10	1	1	18.8	13.07	30.6	P4KE22A	P4KE22CA
P4KE24(C)A-HF	22.80	25.20	1	1	20.5	12.05	33.2	P4KE24A	P4KE24CA
P4KE27(C)A-HF	25.65	28.35	1	1	23.1	10.67	37.5	P4KE27A	P4KE27CA
P4KE30(C)A-HF	28.50	31.50	1	1	25.6	9.66	41.4	P4KE30A	P4KE30CA
P4KE33(C)A-HF	31.35	34.65	1	1	28.2	8.75	45.7	P4KE33A	P4KE33CA
P4KE36(C)A-HF	34.20	37.80	1	1	30.8	8.02	49.9	P4KE36A	P4KE36CA
P4KE39(C)A-HF	37.05	40.95	1	1	33.3	7.42	53.9	P4KE39A	P4KE39CA
P4KE43(C)A-HF	40.85	45.15	1	1	36.8	6.75	59.3	P4KE43A	P4KE43CA
P4KE47(C)A-HF	44.65	49.35	1	1	40.2	6.17	64.8	P4KE47A	P4KE47CA
P4KE51(C)A-HF	48.45	53.55	1	1	43.6	5.71	70.1	P4KE51A	P4KE51CA
P4KE56(C)A-HF	53.20	58.80	1	1	47.8	5.19	77.0	P4KE56A	P4KE56CA
P4KE62(C)A-HF	58.90	65.10	1	1	53.0	4.71	85.0	P4KE62A	P4KE62CA
P4KE68(C)A-HF	64.60	71.40	1	1	58.1	4.35	92.0	P4KE68A	P4KE68CA
P4KE75(C)A-HF	71.25	78.75	1	1	64.1	3.88	103.0	P4KE75A	P4KE75CA
P4KE82(C)A-HF	77.90	86.10	1	1	70.1	3.54	113.0	P4KE82A	P4KE82CA
P4KE91(C)A-HF	86.45	95.55	1	1	77.8	3.20	125.0	P4KE91A	P4KE91CA
P4KE100(C)A-HF	95.00	105.00	1	1	85.5	2.92	137.0	P4KE100A	P4KE100CA
P4KE110(C)A-HF	104.50	115.50	1	1	94.0	2.63	152.0	P4KE110A	P4KE110CA
P4KE120(C)A-HF	114.00	126.00	1	1	102.0	2.42	165.0	P4KE120A	P4KE120CA
P4KE130(C)A-HF	123.50	136.50	1	1	111.0	2.23	179.0	P4KE130A	P4KE130CA
P4KE150(C)A-HF	142.50	157.50	1	1	128.0	1.93	207.0	P4KE150A	P4KE150CA
P4KE160(C)A-HF	152.00	168.00	1	1	136.0	1.83	219.0	P4KE160A	P4KE160CA
P4KE170(C)A-HF	161.50	178.50	1	1	145.0	1.71	234.0	P4KE170A	P4KE170CA
P4KE180(C)A-HF	171.00	189.00	1	1	154.0	1.63	246.0	P4KE180A	P4KE180CA
P4KE200(C)A-HF	190.00	210.00	1	1	171.0	1.46	274.0	P4KE200A	P4KE200CA
P4KE220(C)A-HF	209.00	231.00	1	1	185.0	1.22	328.0	P4KE220A	P4KE220CA
P4KE250(C)A-HF	237.50	262.50	1	1	214.0	1.16	344.0	P4KE250A	P4KE250CA
P4KE300(C)A-HF	285.00	315.00	1	1	256.0	0.97	414.0	P4KE300A	P4KE300CA
P4KE350(C)A-HF	332.50	367.50	1	1	299.3	0.83	482.0	P4KE350A	P4KE350CA
P4KE380(C)A-HF	361.00	399.00	1	1	324.9	0.76	524.4	P4KE380A	P4KE380CA
P4KE400(C)A-HF	380.00	420.00	1	1	342.0	0.72	552.0	P4KE400A	P4KE400CA
P4KE440(C)A-HF	418.00	462.00	1	1	376.2	0.66	607.2	P4KE440A	P4KE440CA
P4KE500(C)A-HF	475.00	525.00	1	1	427.5	0.58	690.0	P4KE500A	P4KE500CA
P4KE520(C)A-HF	494.00	546.00	1	1	444.6	0.56	717.6	P4KE520A	P4KE520CA
P4KE550(C)A-HF	522.50	577.50	1	1	470.3	0.53	759.0	P4KE550A	P4KE550CA
P4KE600(C)A-HF	570.00	630.00	1	1	513.0	0.48	828.0	P4KE600A	P4KE600CA

- Note: 1) Suffix A denotes 5% tolerance devices.
 2) Add suffix "C" or "CA" after part number to specify Bi-directional devices.
 3) For Bi-Directional devices having VR of 10 volts and under, the IR limit is double.

Company reserves the right to improve product design , functions and reliability without notice.

Taping Specification For Axial Lead Diodes

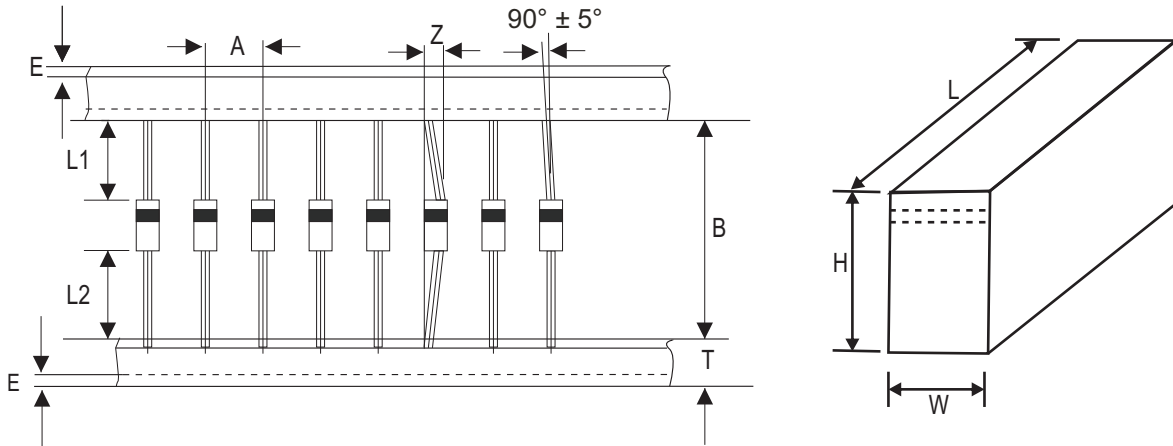

DO-15	SYMBOL	A	B	Z	T	E
	(mm)	5.00 ± 0.50	52.00 ± 0.50	1.20 (max)	6.00 ± 0.40	3.00 (max)
	(inch)	0.197 ± 0.020	2.047 ± 0.020	0.047 (max)	0.236 ± 0.016	0.118 (max)

DO-15	SYMBOL	L1	L2	L	W	H
	(mm)	1.00 (max)	1.00 (max)	260.00	75.00	145.00
	(inch)	0.039 (max)	0.039 (max)	10.236	2.953	5.709

Standard Packaging

Case Type	AMMO PACK	
	BOX (pcs)	CARTON (pcs)
DO-41	5,000	50,000

Mouser Electronics

Authorized Distributor

Click to View Pricing, Inventory, Delivery & Lifecycle Information:

[Comchip Technology:](#)

[P6KE27A-HF](#) [P6KE300-HF](#) [P6KE400-HF](#) [P6KE500-HF](#) [P6KE51A-HF](#) [P4KE39A-HF](#) [P6KE11A-HF](#) [P4KE68CA-HF](#)