



METALLURGICALLY BONDED GLASS SURFACE MOUNT 500 mW ZENERS

Screening in reference to MIL-PRF-19500 available

DESCRIPTION

The 1N5221BUR-1 thru 1N5281BUR-1 series of 0.5 watt Zener voltage regulators provides a surface mount equivalent to the popular JEDEC registered 1N5221 to 1N5281 series for 2.4 to 200 volts in a metallurgically bonded configuration. They are available with standard 5% or 10% tolerances as well as tighter tolerances identified by different suffix letters on the part number. Microsemi also offers numerous other Zener products to meet higher and lower power applications.

Important: For the latest information, visit our website <http://www.microsemi.com>.

FEATURES

- Surface mount equivalent of JEDEC registered 1N5221 thru 1N5281 series.
- Voltage tolerances of 10%, 5%, 2%, and 1% available.
- Hermetically sealed surface mount package.
- Internal metallurgical bond.
- Up-screening in reference to MIL-PRF-19500 is available. (See [part nomenclature](#) for all available options.)
- RoHS compliant versions available (commercial grade only).

DO-213AA Package

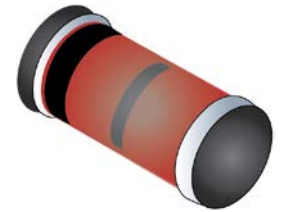

Also available in:

 **DO-35 (DO-204AH)**
(axial-leaded)
[1N5221B-1 thru 1N5281B-1](#)

APPLICATIONS / BENEFITS

- Regulates voltage over a broad operating current and temperature range.
- Extensive selection from 2.4 to 200 V.
- Non-sensitive to ESD (MIL-STD-750 method 1020).
- Minimal capacitance (see [Figure 3](#)).
- Inherently radiation hard per Microsemi "[MicroNote 050](#)".

MAXIMUM RATINGS

Parameters/Test Conditions	Symbol	Value	Unit
Junction and Storage Temperature	T _J and T _{STG}	-65 to +175	°C
Thermal Resistance Junction-to-Ambient ⁽¹⁾	R _{θJA}	250	°C/W
Thermal Resistance Junction-to-End Cap	R _{θJEC}	100	°C/W
Steady-State Power Dissipation ⁽²⁾	P _D	0.5	W
Forward Voltage @ 200 mA	V _F	1.1	V
Solder Temperature @ 10 s	T _{SP}	260	°C

- Notes:**
1. When mounted on FR4 PC board (1 oz Cu) with recommended footprint (see last page).
 2. At end cap temperature T_{EC} ≤ 125 °C or ambient temperature T_A ≤ 50 °C when mounted on FR4 PC board as described for thermal resistance above (see [Figure 2](#) for derating).

MSC – Lawrence

6 Lake Street,
Lawrence, MA 01841
Tel: 1-800-446-1158 or
(978) 620-2600
Fax: (978) 689-0803

MSC – Ireland

Gort Road Business Park,
Ennis, Co. Clare, Ireland
Tel: +353 (0) 65 6840044
Fax: +353 (0) 65 6822298

Website:

www.microsemi.com

MECHANICAL and PACKAGING

- CASE: Hermetically sealed glass DO-213AA (SOD80 or MLL34) MELF style package.
- TERMINALS: End caps tin-lead or RoHS compliant annealed matte-tin plating (commercial grade only) solderable per MIL-STD-750, method 2026.
- MARKING: Cathode band only.
- POLARITY: Cathode indicated by band where diode is to be operated with the banded end positive with respect to the opposite end for Zener regulation.
- TAPE & REEL option: Standard per EIA-481-B (add "TR" suffix to part number). Consult factory for quantities.
- WEIGHT: 0.04 grams.
- See [Package Dimensions](#) on last page.

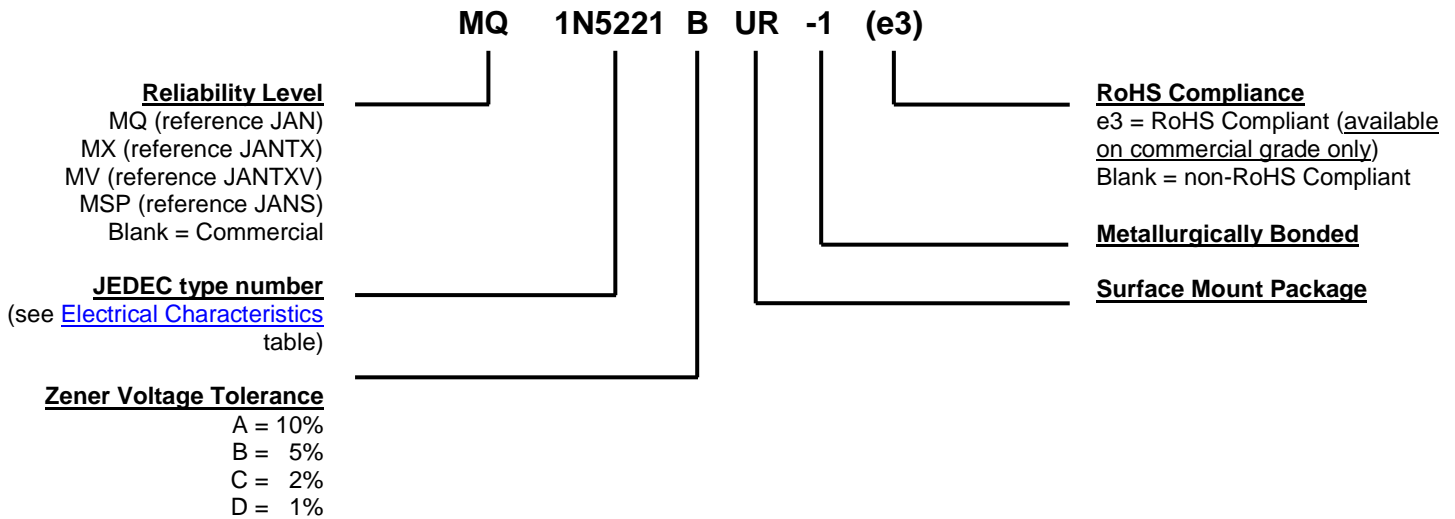
PART NOMENCLATURE

SYMBOLS & DEFINITIONS

Symbol	Definition
I_R	Reverse Current: The maximum reverse (leakage) current that will flow at the specified voltage and temperature.
I_Z, I_{ZT}, I_{ZK}	Regulator Current: The dc regulator current (I_Z), at a specified test point (I_{ZT}), near breakdown knee (I_{ZK}).
I_{ZM}	Maximum Regulator (Zener) Current: The maximum rated dc current for the specified power rating.
T_{SP}	Temperature Solder Pad: The maximum solder temperature that can be safely applied to the terminal.
V_R	Reverse Voltage: The reverse voltage dc value, no alternating component.
V_Z	Zener Voltage: The Zener voltage the device will exhibit at a specified current (I_Z) in its breakdown region.
Z_{ZT} or Z_{ZK}	Dynamic Impedance: The small signal impedance of the diode when biased to operate in its breakdown region at a specified rms current modulation (typically 10% of I_{ZT} or I_{ZK}) and superimposed on I_{ZT} or I_{ZK} respectively.

ELECTRICAL CHARACTERISTICS @ 25 °C unless otherwise noted.*

INDUSTRY PART NUMBER (Notes 1 & 4)	Nominal Zener Voltage V_z @ I_{ZT} (Note 2) Volts	Test Current I_{ZT} mA	Max Zener Impedance		Max Reverse Leakage Current			Max Zener Voltage Temp. Coeff. (Note 3) α_{Vz} (% / °C)
			Z_{ZT} @ I_{ZT} Ohms	Z_{ZK} @ $I_{ZK} = 0.25$ mA Ohms	I_R μ A	@ V_R Volts		
						A	B, C & D	
1N5221BUR-1	2.4	20	30	1200	100	0.95	1.0	-0.085
1N5222BUR-1	2.5	20	30	1250	100	0.95	1.0	-0.085
1N5223BUR-1	2.7	20	30	1300	75	0.95	1.0	-0.080
1N5224BUR-1	2.8	20	30	1400	75	0.95	1.0	-0.080
1N5225BUR-1	3.0	20	29	1600	50	0.95	1.0	-0.075
1N5226BUR-1	3.3	20	28	1600	25	0.95	1.0	-0.070
1N5227BUR-1	3.6	20	24	1700	15	0.95	1.0	-0.065
1N5228BUR-1	3.9	20	23	1900	10	0.95	1.0	-0.060
1N5229BUR-1	4.3	20	22	2000	5.0	0.95	1.0	+/-0.055
1N5230BUR-1	4.7	20	19	1900	50	1.9	2.0	+/-0.030
1N5231BUR-1	5.1	20	17	1600	5.0	1.9	2.0	+/-0.030
1N5232BUR-1	5.6	20	11	1600	5.0	2.9	3.0	+0.038
1N5233BUR-1	6.0	20	7.0	1600	5.0	3.3	3.5	+0.038
1N5234BUR-1	6.2	20	7.0	1000	5.0	3.8	4.0	+0.045
1N5235BUR-1	6.8	20	5.0	750	3.0	4.8	5.0	+0.050
1N5236BUR-1	7.5	20	6.0	500	3.0	5.7	6.0	+0.058
1N5237BUR-1	8.2	20	8.0	500	3.0	6.2	6.5	+0.062
1N5238BUR-1	8.7	20	8.0	600	3.0	6.2	6.5	+0.065
1N5239BUR-1	9.1	20	10	600	3.0	6.7	7.0	+0.068
1N5240BUR-1	10	20	17	600	3.0	7.6	8.0	+0.075
1N5241BUR-1	11	20	22	600	2.0	8.0	8.4	+0.076
1N5242BUR-1	12	20	30	600	1.0	8.7	9.1	+0.077
1N5243BUR-1	13	9.5	13	600	0.5	9.4	9.9	+0.079
1N5244BUR-1	14	9.0	15	600	0.1	9.5	10	+0.082
1N5245BUR-1	15	8.5	16	600	0.1	10.5	11	+0.082
1N5246BUR-1	16	7.8	17	600	0.1	11.4	12	+0.083
1N5247BUR-1	17	7.4	19	600	0.1	12.4	13	+0.084
1N5248BUR-1	18	7.0	21	600	0.1	13.3	14	+0.085
1N5249BUR-1	19	6.6	23	600	0.1	13.3	14	+0.086
1N5250BUR-1	20	6.2	25	600	0.1	14.3	15	+0.086
1N5251BUR-1	22	5.6	29	600	0.1	16.2	17	+0.087
1N5252BUR-1	24	5.2	33	600	0.1	17.1	18	+0.088
1N5253BUR-1	25	5.0	35	600	0.1	18.1	19	+0.089
1N5254BUR-1	27	4.6	41	600	0.1	20	21	+0.090
1N5255BUR-1	28	4.5	44	600	0.1	20	21	+0.091
1N5256BUR-1	30	4.2	49	600	0.1	22	23	+0.091
1N5257BUR-1	33	3.8	58	700	0.1	24	25	+0.092
1N5258BUR-1	36	3.4	70	700	0.1	26	27	+0.093
1N5259BUR-1	39	3.2	80	800	0.1	29	30	+0.094
1N5260BUR-1	43	3.0	93	900	0.1	31	33	+0.095
1N5261BUR-1	47	2.7	105	1000	0.1	34	36	+0.095
1N5262BUR-1	51	2.5	125	1100	0.1	37	39	+0.096
1N5263BUR-1	56	2.2	150	1300	0.1	41	43	+0.096
1N5264BUR-1	60	2.1	170	1400	0.1	44	46	+0.097
1N5265BUR-1	62	2.0	185	1400	0.1	45	47	+0.097
1N5266BUR-1	68	1.8	230	1600	0.1	49	52	+0.097
1N5267BUR-1	75	1.7	270	1700	0.1	53	56	+0.098
1N5268BUR-1	82	1.5	330	2000	0.1	59	62	+0.098
1N5269BUR-1	87	1.4	370	2200	0.1	65	68	+0.099
1N5270BUR-1	91	1.4	400	2300	0.1	66	69	+0.099
1N5271BUR-1	100	1.3	500	2600	0.1	72	76	+0.110
1N5272BUR-1	110	1.1	750	3000	0.1	80	84	+0.110
1N5273BUR-1	120	1.0	900	4000	0.1	86	91	+0.110
1N5274BUR-1	130	0.95	1100	4500	0.1	94	99	+0.110
1N5275BUR-1	140	0.90	1300	4500	0.1	101	106	+0.110
1N5276BUR-1	150	0.85	1500	5000	0.1	108	114	+0.110
1N5277BUR-1	160	0.80	1700	5500	0.1	116	122	+0.110
1N5278BUR-1	170	0.74	1900	5500	0.1	123	129	+0.110
1N5279BUR-1	180	0.68	2200	6000	0.1	130	137	+0.110
1N5280BUR-1	190	0.66	2400	6500	0.1	137	144	+0.110
1N5281BUR-1	200	0.65	2500	7000	0.1	144	152	+0.110

* $T_A = +25$ °C unless otherwise noted. Based on dc measurements at thermal equilibrium; case temperature maintained at 30 ± 2 °C. $V_F = 1.1$ V max @ $I_F = 200$ mA for all types. See further notes on following page.

NOTE 1: Table as shown lists type numbers, which indicate a tolerance of +/- 5%. Devices with guaranteed limits on all six parameters are indicated by suffix "A" for +/- 10%, "B" for +/- 5%, "C" for +/- 2%, and "D" for +/- 1% tolerance.

NOTE 2: The electrical characteristics are measured after allowing the device to stabilize for 20 seconds.

NOTE 3: Temperature coefficient (α_{vz}). Test conditions for temperature coefficient are as follows:

- a. $I_{ZT} = 20 \text{ mA}$, $T_1 = 25 \text{ }^\circ\text{C}$,
 $T_2 = 125 \text{ }^\circ\text{C}$ (1N5221AUR-1 & BUR-1 thru 1N5242AUR-1 & BUR-1)
- b. $I_{ZT} = \text{Rated } I_{ZT}$, $T_1 = 25 \text{ }^\circ\text{C}$,
 $T_2 = 125 \text{ }^\circ\text{C}$ (1N5243AUR-1 & BUR-1 thru 1N5281AUR-1 & BUR-1)

Device to be temperature stabilized with current applied prior to reading breakdown voltage at the specified ambient temperature.

GRAPHS

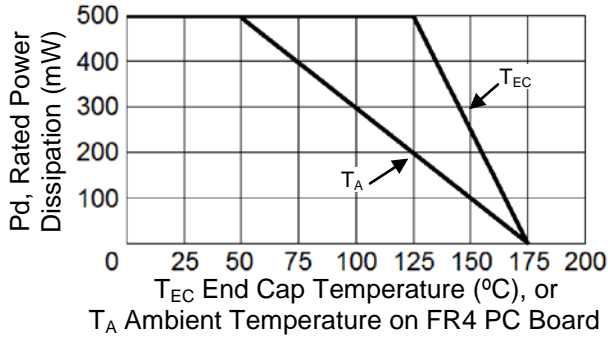

FIGURE 1
POWER DERATING CURVE

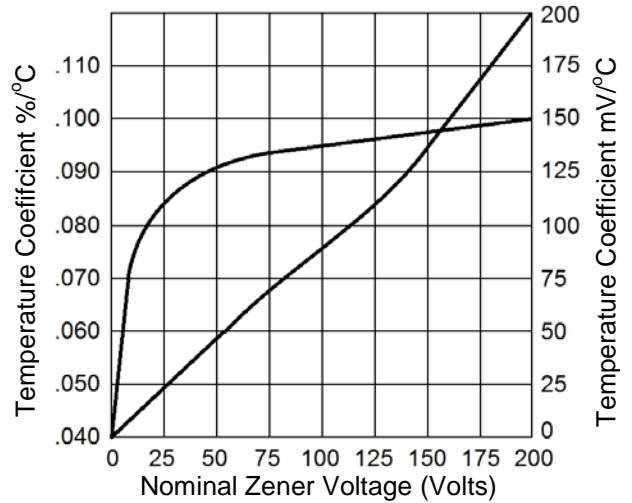

FIGURE 2
ZENER VOLTAGE TEMPERATURE COEFFICIENT vs. ZENER VOLTAGE

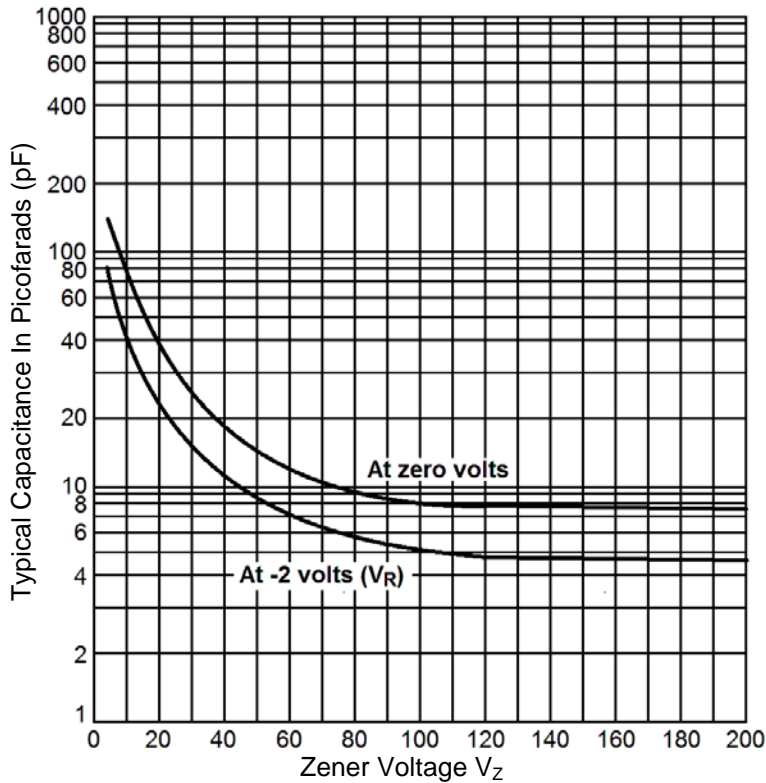
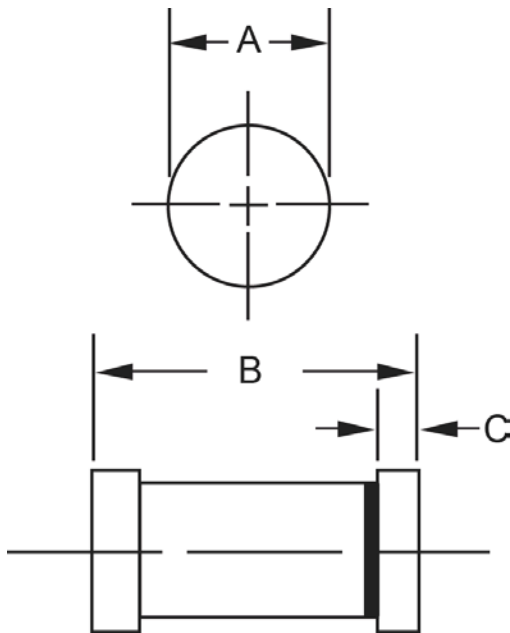
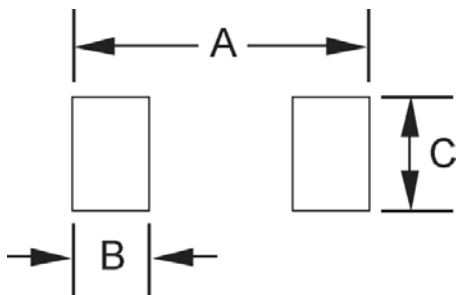

FIGURE 3
CAPACITANCE vs. ZENER VOLTAGE (TYPICAL)

PACKAGE DIMENSIONS

DIM	INCHES		MILLIMETERS	
	MIN	MAX	MIN	MAX
A	0.063	0.067	1.60	1.70
B	0.130	0.146	3.30	3.70
C	0.016	0.022	0.41	0.55

PAD LAYOUT

	INCHES	mm
A	.200	5.08
B	.055	1.40
C	.080	2.03