

BC856ALT1G Series

General Purpose Transistors

PNP Silicon

Features

- S and NSV Prefix for Automotive and Other Applications Requiring Unique Site and Control Change Requirements; AEC-Q101 Qualified and PPAP Capable
- These Devices are Pb-Free, Halogen Free/BFR Free and are RoHS Compliant

MAXIMUM RATINGS ($T_A = 25^\circ\text{C}$ unless otherwise noted)

Rating	Symbol	Value	Unit
Collector-Emitter Voltage BC856, SBC856 BC857, SBC857 BC858, NSVBC858, BC859	V_{CEO}	-65 -45 -30	V
Collector-Base Voltage BC856, SBC856 BC857, SBC857 BC858, NSVBC858, BC859	V_{CBO}	-80 -50 -30	V
Emitter-Base Voltage	V_{EBO}	-5.0	V
Collector Current – Continuous	I_C	-100	mAdc
Collector Current – Peak	I_C	-200	mAdc

THERMAL CHARACTERISTICS

Characteristic	Symbol	Max	Unit
Total Device Dissipation FR-5 Board, (Note 1) $T_A = 25^\circ\text{C}$ Derate above 25°C	P_D	225 1.8	mW mW/ $^\circ\text{C}$
Thermal Resistance, Junction-to-Ambient	$R_{\theta JA}$	556	$^\circ\text{C}/\text{W}$
Total Device Dissipation Alumina Substrate, (Note 2) $T_A = 25^\circ\text{C}$ Derate above 25°C	P_D	300 2.4	mW mW/ $^\circ\text{C}$
Thermal Resistance, Junction-to-Ambient	$R_{\theta JA}$	417	$^\circ\text{C}/\text{W}$
Junction and Storage Temperature	T_J, T_{stg}	-55 to +150	$^\circ\text{C}$

Stresses exceeding those listed in the Maximum Ratings table may damage the device. If any of these limits are exceeded, device functionality should not be assumed, damage may occur and reliability may be affected.

1. FR-5 = $1.0 \times 0.75 \times 0.062$ in.
2. Alumina = $0.4 \times 0.3 \times 0.024$ in 99.5% alumina.



ON Semiconductor®

www.onsemi.com

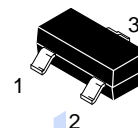
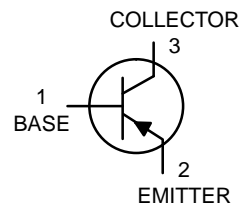

SOT-23 (TO-236)
CASE 318
STYLE 6

MARKING DIAGRAM



- xx = Device Code
xx = (Refer to page 6)
- M = Date Code*
- = Pb-Free Package

(Note: Microdot may be in either location)
*Date Code orientation and/or overbar may vary depending upon manufacturing location.

ORDERING INFORMATION

See detailed ordering and shipping information in the package dimensions section on page 6 of this data sheet.

BC856ALT1G Series

ELECTRICAL CHARACTERISTICS ($T_A = 25^\circ\text{C}$ unless otherwise noted)

Characteristic	Symbol	Min	Typ	Max	Unit
OFF CHARACTERISTICS					
Collector–Emitter Breakdown Voltage ($I_C = -10\text{ mA}$)	BC856, SBC856 Series BC857, SBC857 Series BC858, NSVBC858 BC859 Series	$V_{(BR)CEO}$	-65 -45 -30	- - -	V
Collector–Emitter Breakdown Voltage ($I_C = -10\ \mu\text{A}$, $V_{EB} = 0$)	BC856 S, SBC856series BC857A, SBC857A, BC857B, SBC857B Only BC858, NSVB858, BC859 Series	$V_{(BR)CES}$	-80 -50 -30	- - -	V
Collector–Base Breakdown Voltage ($I_C = -10\ \mu\text{A}$)	BC856, SBC856 Series BC857, SBC857 Series BC858, NSVBC858, BC859 Series	$V_{(BR)CBO}$	-80 -50 -30	- - -	V
Emitter–Base Breakdown Voltage ($I_E = -1.0\ \mu\text{A}$)	BC856, SBC856 Series BC857, SBC857 Series BC858, NSVBC858, BC859 Series	$V_{(BR)EBO}$	-5.0 -5.0 -5.0	- - -	V
Collector Cutoff Current ($V_{CB} = -30\text{ V}$) ($V_{CB} = -30\text{ V}$, $T_A = 150^\circ\text{C}$)		I_{CBO}	- -	- -	nA μA

ON CHARACTERISTICS

DC Current Gain ($I_C = -10\ \mu\text{A}$, $V_{CE} = -5.0\text{ V}$)	BC856A, SBC856A, BC857A, SBC857A, BC858A BC856B, SBC856B, BC857B, SBC857B, BC858B, NSVBC858B BC857C, SBC857C BC858C	h_{FE}	- - -	90 150 270	- - -	-
($I_C = -2.0\text{ mA}$, $V_{CE} = -5.0\text{ V}$)	BC856A, SBC856A, BC857A, SBC857A, BC858A BC856B, SBC856B, BC857B, SBC857B, BC858B, NSVBC858B, BC859B BC857C, SBC857C, BC858C, BC859C		125 220 420	180 290 520	250 475 800	
Collector–Emitter Saturation Voltage ($I_C = -10\text{ mA}$, $I_B = -0.5\text{ mA}$) ($I_C = -100\text{ mA}$, $I_B = -5.0\text{ mA}$)		$V_{CE(sat)}$	- -	- -	-0.3 -0.65	V
Base–Emitter Saturation Voltage ($I_C = -10\text{ mA}$, $I_B = -0.5\text{ mA}$) ($I_C = -100\text{ mA}$, $I_B = -5.0\text{ mA}$)		$V_{BE(sat)}$	- -	-0.7 -0.9	- -	V
Base–Emitter On Voltage ($I_C = -2.0\text{ mA}$, $V_{CE} = -5.0\text{ V}$) ($I_C = -10\text{ mA}$, $V_{CE} = -5.0\text{ V}$)		$V_{BE(on)}$	-0.6 -	- -	-0.75 -0.82	V

SMALL–SIGNAL CHARACTERISTICS

Current–Gain – Bandwidth Product ($I_C = -10\text{ mA}$, $V_{CE} = -5.0\text{ Vdc}$, $f = 100\text{ MHz}$)		f_T	100	-	-	MHz
Output Capacitance ($V_{CB} = -10\text{ V}$, $f = 1.0\text{ MHz}$)		C_{ob}	-	-	4.5	pF
Noise Figure ($I_C = -0.2\text{ mA}$, $V_{CE} = -5.0\text{ Vdc}$, $R_S = 2.0\text{ k}\Omega$, $f = 1.0\text{ kHz}$, $BW = 200\text{ Hz}$) BC856, SBC856, BC857, SBC857, BC858, NSVBC858 Series BC859 Series		NF	- -	- -	10 4.0	dB

Product parametric performance is indicated in the Electrical Characteristics for the listed test conditions, unless otherwise noted. Product performance may not be indicated by the Electrical Characteristics if operated under different conditions.

BC856ALT1G Series

BC857/BC858/BC859/SBC857/NSVBC858

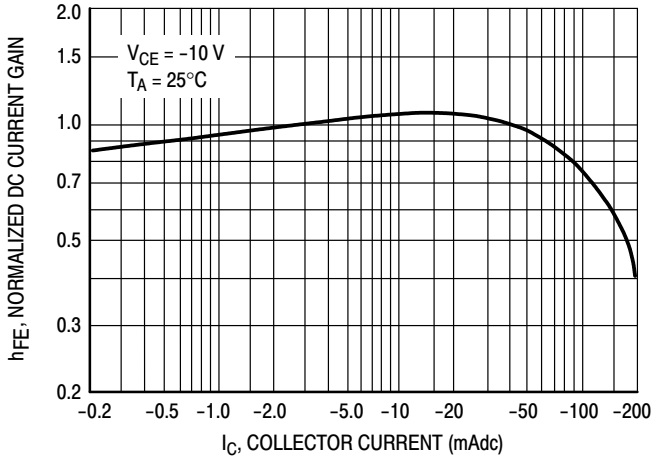

Figure 1. Normalized DC Current Gain

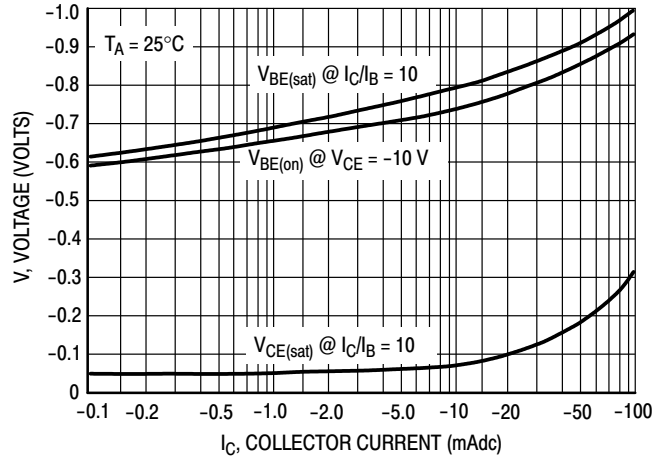

Figure 2. "Saturation" and "On" Voltages

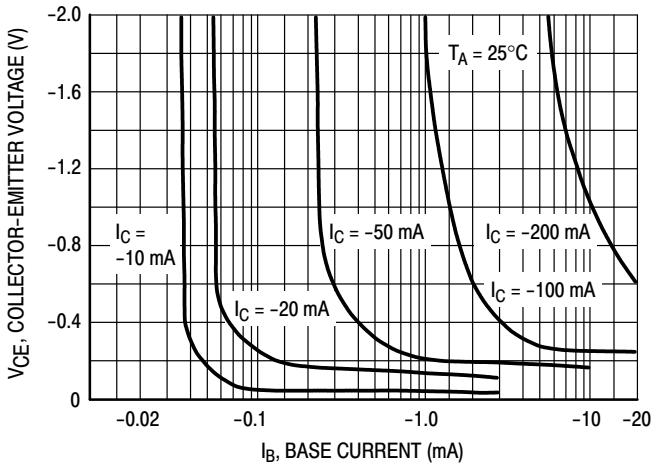

Figure 3. Collector Saturation Region

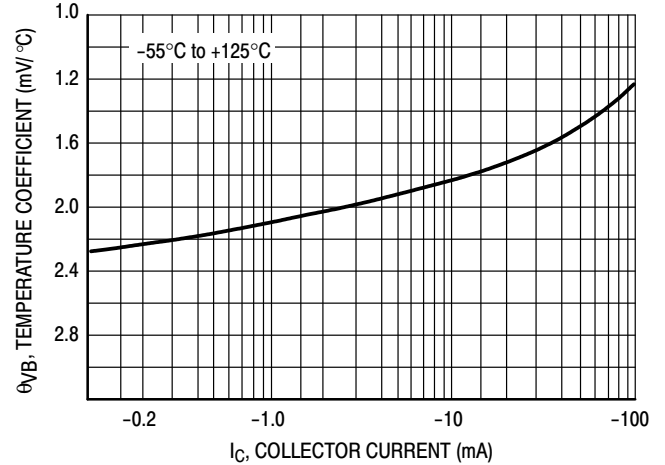

Figure 4. Base-Emitter Temperature Coefficient

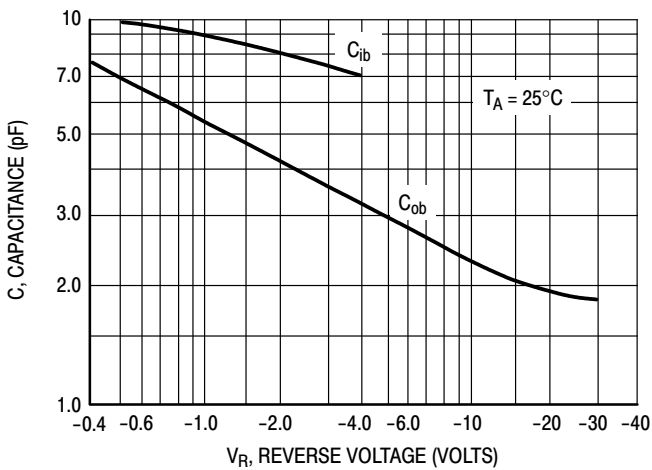

Figure 5. Capacitances

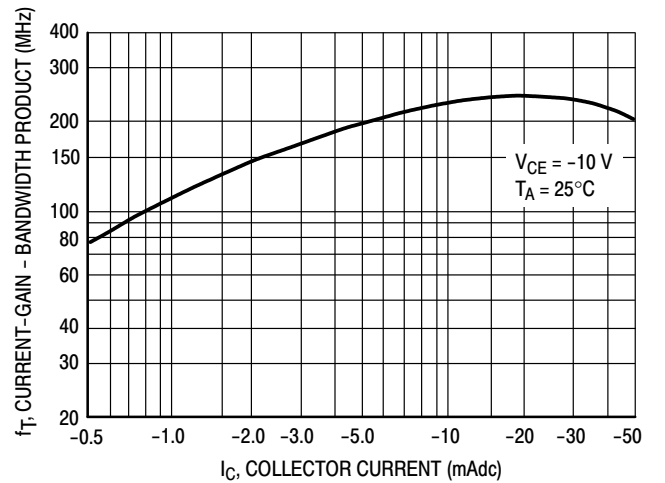

Figure 6. Current-Gain - Bandwidth Product

BC856ALT1G Series

BC856/SBC856

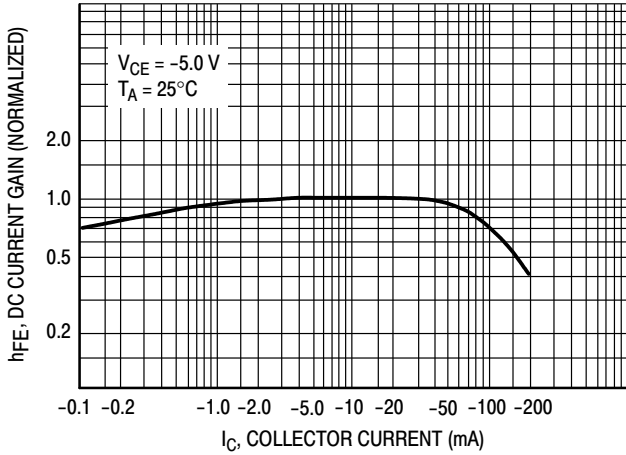

Figure 7. DC Current Gain

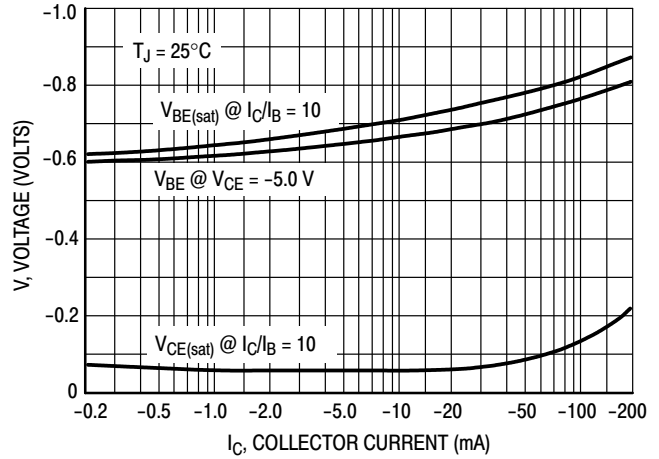

Figure 8. "On" Voltage

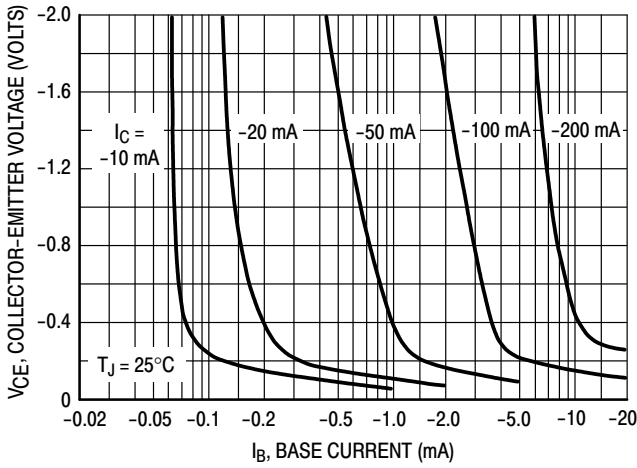

Figure 9. Collector Saturation Region

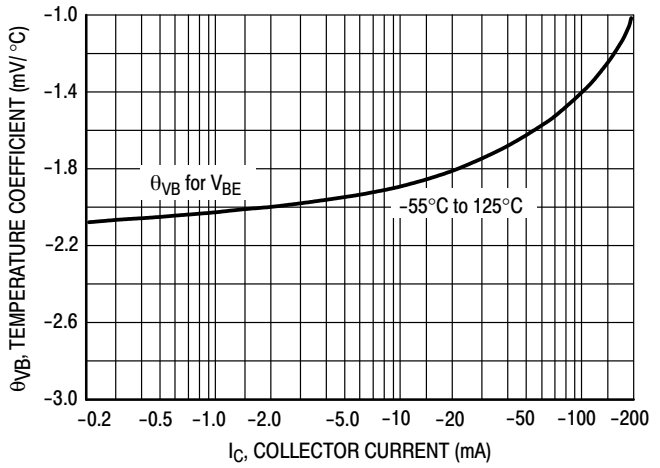

Figure 10. Base-Emitter Temperature Coefficient

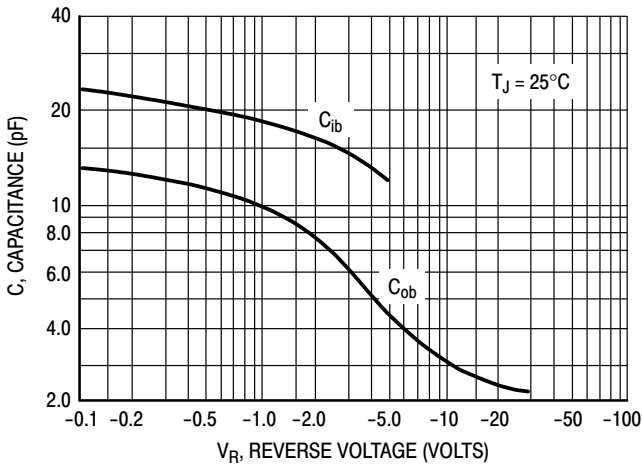

Figure 11. Capacitance

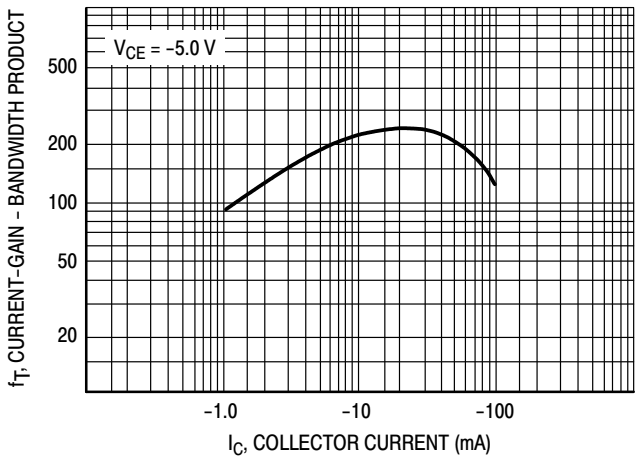

Figure 12. Current-Gain - Bandwidth Product

BC856ALT1G Series

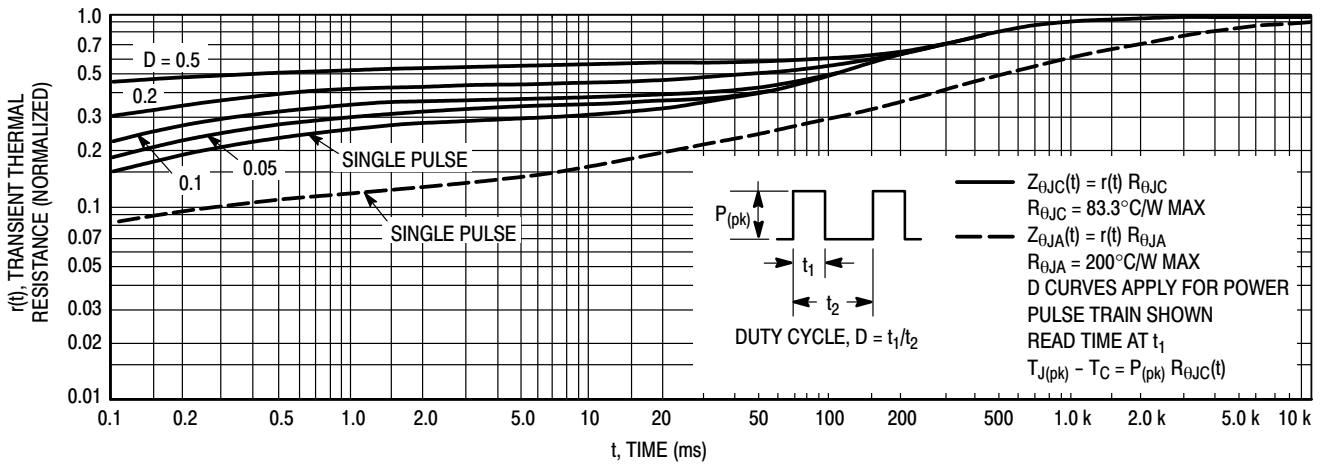

Figure 13. Thermal Response

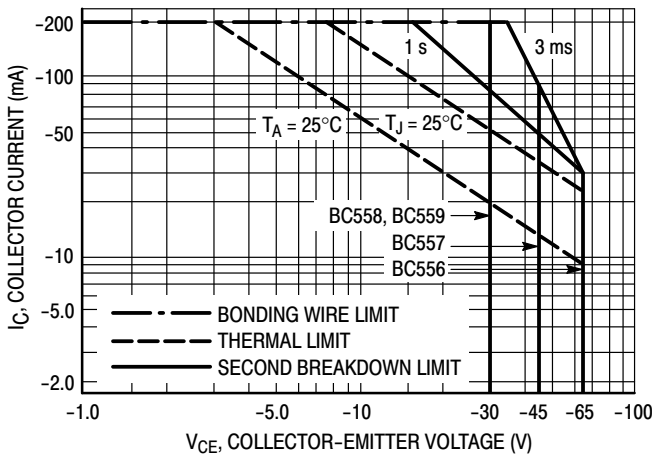

Figure 14. Active Region Safe Operating Area

The safe operating area curves indicate I_C - V_{CE} limits of the transistor that must be observed for reliable operation. Collector load lines for specific circuits must fall below the limits indicated by the applicable curve.

The data of Figure 14 is based upon $T_{J(pk)} = 150^{\circ}C$; T_C or T_A is variable depending upon conditions. Pulse curves are valid for duty cycles to 10% provided $T_{J(pk)} \leq 150^{\circ}C$. $T_{J(pk)}$ may be calculated from the data in Figure 13. At high case or ambient temperatures, thermal limitations will reduce the power that can be handled to values less than the limitations imposed by the secondary breakdown.

BC856ALT1G Series

ORDERING INFORMATION

Device	Marking	Package	Shipping†
BC856ALT1G	3A	SOT-23 (Pb-Free)	3,000 / Tape & Reel
SBC856ALT1G*			
BC856ALT3G			10,000 / Tape & Reel
BC856BLT1G	3B	SOT-23 (Pb-Free)	3,000 / Tape & Reel
SBC856BLT1G*			
BC856BLT3G			10,000 / Tape & Reel
SBC856BLT3G*			
BC857ALT1G	3E	SOT-23 (Pb-Free)	3,000 / Tape & Reel
SBC857ALT1G*			
BC857BLT1G	3F	SOT-23 (Pb-Free)	3,000 / Tape & Reel
SBC857BLT1G*			
BC857BLT3G			10,000 / Tape & Reel
NSVBC857BLT3G*			
BC857CLT1G	3G	SOT-23 (Pb-Free)	3,000 / Tape & Reel
SBC857CLT1G*			
BC857CLT3G			10,000 / Tape & Reel
BC858ALT1G	3J	SOT-23 (Pb-Free)	3,000 / Tape & Reel
BC858BLT1G	3K	SOT-23 (Pb-Free)	
NSVBC858BLT1G*			
BC858BLT3G	3L	SOT-23 (Pb-Free)	10,000 / Tape & Reel
BC858CLT1G		SOT-23 (Pb-Free)	3,000 / Tape & Reel
BC858CLT3G		SOT-23 (Pb-Free)	10,000 / Tape & Reel
BC859BLT1G	4B	SOT-23 (Pb-Free)	3,000 / Tape & Reel
BC859BLT3G		SOT-23 (Pb-Free)	10,000 / Tape & Reel
BC859CLT1G	4C	SOT-23 (Pb-Free)	3,000 / Tape & Reel
BC859CLT3G		SOT-23 (Pb-Free)	10,000 / Tape & Reel

†For information on tape and reel specifications, including part orientation and tape sizes, please refer to our Tape and Reel Packaging Specifications Brochure, BRD8011/D.

*S and NSV Prefix for Automotive and Other Applications Requiring Unique Site and Control Change Requirements; AEC-Q101 Qualified and PPAP Capable.

BC856ALT1G Series

PACKAGE DIMENSIONS

SOT-23 (TO-236)
CASE 318-08
ISSUE AR

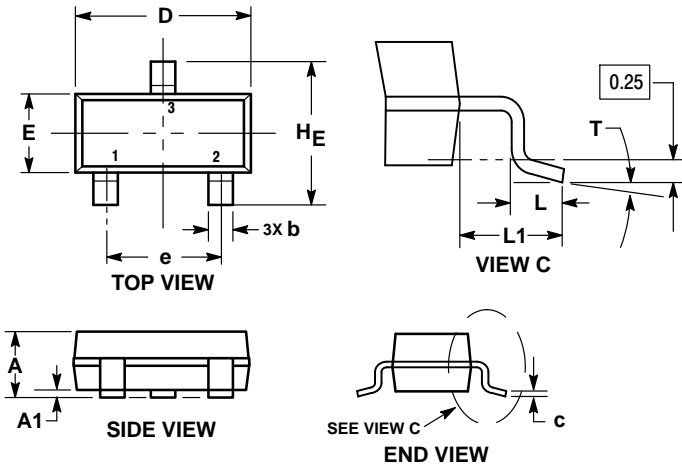

NOTES:

1. DIMENSIONING AND TOLERANCING PER ASME Y14.5M, 1994.
2. CONTROLLING DIMENSION: MILLIMETERS.
3. MAXIMUM LEAD THICKNESS INCLUDES LEAD FINISH. MINIMUM LEAD THICKNESS IS THE MINIMUM THICKNESS OF THE BASE MATERIAL.
4. DIMENSIONS D AND E DO NOT INCLUDE MOLD FLASH, PROTRUSIONS, OR GATE BURRS.

DIM	MILLIMETERS			INCHES		
	MIN	NOM	MAX	MIN	NOM	MAX
A	0.89	1.00	1.11	0.035	0.039	0.044
A1	0.01	0.06	0.10	0.000	0.002	0.004
b	0.37	0.44	0.50	0.015	0.017	0.020
c	0.08	0.14	0.20	0.003	0.006	0.008
D	2.80	2.90	3.04	0.110	0.114	0.120
E	1.20	1.30	1.40	0.047	0.051	0.055
e	1.78	1.90	2.04	0.070	0.075	0.080
L	0.30	0.43	0.55	0.012	0.017	0.022
L1	0.35	0.54	0.69	0.014	0.021	0.027
HE	2.10	2.40	2.64	0.083	0.094	0.104
T	0°	---	10°	0°	---	10°

STYLE 6:

1. BASE
2. EMITTER
3. COLLECTOR

RECOMMENDED SOLDERING FOOTPRINT*

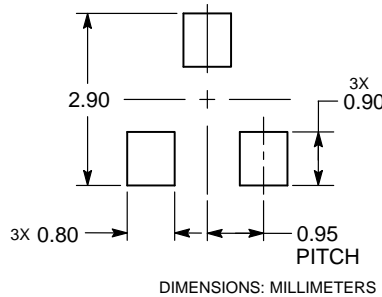

*For additional information on our Pb-Free strategy and soldering details, please download the ON Semiconductor Soldering and Mounting Techniques Reference Manual, SOLDERRM/D.

ON Semiconductor and are trademarks of Semiconductor Components Industries, LLC dba ON Semiconductor or its subsidiaries in the United States and/or other countries. ON Semiconductor owns the rights to a number of patents, trademarks, copyrights, trade secrets, and other intellectual property. A listing of ON Semiconductor's product/patent coverage may be accessed at www.onsemi.com/site/pdf/Patent-Marking.pdf. ON Semiconductor reserves the right to make changes without further notice to any products herein. ON Semiconductor makes no warranty, representation or guarantee regarding the suitability of its products for any particular purpose, nor does ON Semiconductor assume any liability arising out of the application or use of any product or circuit, and specifically disclaims any and all liability, including without limitation special, consequential or incidental damages. Buyer is responsible for its products and applications using ON Semiconductor products, including compliance with all laws, regulations and safety requirements or standards, regardless of any support or applications information provided by ON Semiconductor. "Typical" parameters which may be provided in ON Semiconductor data sheets and/or specifications can and do vary in different applications and actual performance may vary over time. All operating parameters, including "Typicals" must be validated for each customer application by customer's technical experts. ON Semiconductor does not convey any license under its patent rights nor the rights of others. ON Semiconductor products are not designed, intended, or authorized for use as a critical component in life support systems or any FDA Class 3 medical devices or medical devices with a same or similar classification in a foreign jurisdiction or any devices intended for implantation in the human body. Should Buyer purchase or use ON Semiconductor products for any such unintended or unauthorized application, Buyer shall indemnify and hold ON Semiconductor and its officers, employees, subsidiaries, affiliates, and distributors harmless against all claims, costs, damages, and expenses, and reasonable attorney fees arising out of, directly or indirectly, any claim of personal injury or death associated with such unintended or unauthorized use, even if such claim alleges that ON Semiconductor was negligent regarding the design or manufacture of the part. ON Semiconductor is an Equal Opportunity/Affirmative Action Employer. This literature is subject to all applicable copyright laws and is not for resale in any manner.

PUBLICATION ORDERING INFORMATION

LITERATURE FULFILLMENT:
Literature Distribution Center for ON Semiconductor
19521 E. 32nd Pkwy, Aurora, Colorado 80011 USA
Phone: 303-675-2175 or 800-344-3860 Toll Free USA/Canada
Fax: 303-675-2176 or 800-344-3867 Toll Free USA/Canada
Email: orderlit@onsemi.com

N. American Technical Support: 800-282-9855 Toll Free USA/Canada
Europe, Middle East and Africa Technical Support:
Phone: 421 33 790 2910
Japan Customer Focus Center
Phone: 81-3-5817-1050

ON Semiconductor Website: www.onsemi.com
Order Literature: <http://www.onsemi.com/orderlit>
For additional information, please contact your local Sales Representative