

\* Preferred device  
 Dispositif recommandé

**Fast switching**  
 Commutation rapide

**Chopper**  
 Découpeur

$I_{DSS}$	30 mA	min.	2N 4091, A
	15 mA	min.	2N 4092, A
	8 mA	min.	2N 4093, A
$r_{DS\ on}$	30 $\Omega$	max.	2N 4091, A
	50 $\Omega$	max.	2N 4092, A
	80 $\Omega$	max.	2N 4093, A

**Maximum power dissipation**  
 Dissipation de puissance maximale

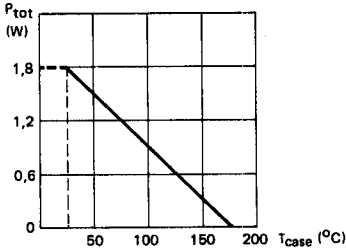

**Case TO-18** — See outline drawing CB-6 on last pages  
 Boîtier Voir dessin coté CB-6 dernières pages



Weight : 0,32 g.  
 Masse

Gate is connected to case  
 La grille est reliée au boîtier

**ABSOLUTE RATINGS ( LIMITING VALUES )**  
 VALEURS LIMITES ABSOLUES D'UTILISATION

$T_{amb} = + 25\ ^\circ C$

( unless otherwise stated )  
 ( sauf indication contraire )

		2N 4091, 2N 4092 2N 4093		2N 4091 A, 2N 4092 A 2N 4093 A		
Drain source voltage Tension drain source	$V_{DS}$	40	50			V
Gate source voltage Tension grille source	$V_{GS}$	- 40	- 50			V
Gate drain voltage Tension grille drain	$V_{GD}$	- 40	- 50			V
Gate current Courant de grille	$I_G$	10	10			mA
Power dissipation Dissipation de puissance	$T_{case}\ 25\ ^\circ C$ $P_{tot}$	1,8	1,8			W
Junction temperature Température de jonction	max $T_j$	+175	+175			°C
Storage temperature Température de stockage	min max $T_{stg}$	- 55 +200	- 55 +200			°C °C

**STATIC CHARACTERISTICS** ( unless otherwise stated )  
**CARACTÉRISTIQUES STATIQUES**  $T_{amb} = + 25\text{ }^{\circ}\text{C}$   
( sauf indication contraire )

	Test conditions <i>Conditions de mesure</i>			min	typ	max	
Total leakage gate current <i>Courant de fuite total de grille</i>	$V_{GS} = -20\text{ V}$ $V_{DS} = 0$	$I_{GSS}$	2N 4091 2N 4092 2N 4093			-0,2	nA
	$V_{GS} = -20\text{ V}$ $V_{DS} = 0$		2N 4091 A 2N 4092 A 2N 4093 A			-0,025	nA
	$V_{GS} = -20\text{ V}$ $V_{DS} = 0$ $T_{amb} = 150\text{ }^{\circ}\text{C}$		2N 4091 2N 4092 2N 4093			-0,4	$\mu\text{A}$
	$V_{GS} = -20\text{ V}$ $V_{DS} = 0$ $T_{amb} = 150\text{ }^{\circ}\text{C}$		2N 4091 A 2N 4092 A 2N 4093 A			-0,05	$\mu\text{A}$
Gate source breakdown voltage <i>Tension de claquage grille source</i>	$V_{DS} = 0\text{ V}$ $I_G = -1\text{ }\mu\text{A}$	$V_{(BR)GSS}$	2N 4091 2N 4092 2N 4093	-40			V
			2N 4091 A 2N 4092 A 2N 4093 A	-50			V
Drain cut-off current <i>Courant résiduel de drain</i>	$V_{DS} = 20\text{ V}$ $V_{GS} = -12\text{ V}$	$I_{DSX}$	2N 4091 2N 4091 A			0,2 0,025	nA nA
	$V_{DS} = 20\text{ V}$ $V_{GS} = -8\text{ V}$		2N 4092 2N 4092 A			0,2 0,025	nA nA
	$V_{DS} = 20\text{ V}$ $V_{GS} = -6\text{ V}$		2N 4093 2N 4093 A			0,2 0,025	nA nA
	$V_{DS} = 20\text{ V}$ $V_{GS} = -12\text{ V}$ $T_{amb} = 150\text{ }^{\circ}\text{C}$		2N 4091 2N 4091 A			0,4 0,05	$\mu\text{A}$ $\mu\text{A}$
	$V_{DS} = 20\text{ V}$ $V_{GS} = -8\text{ V}$ $T_{amb} = 150\text{ }^{\circ}\text{C}$		2N 4092 2N 4092 A			0,4 0,05	$\mu\text{A}$ $\mu\text{A}$
	$V_{DS} = 20\text{ V}$ $V_{GS} = -6\text{ V}$ $T_{amb} = 150\text{ }^{\circ}\text{C}$		2N 4093 2N 4093 A			0,4 0,05	$\mu\text{A}$ $\mu\text{A}$
Drain current <i>Courant de drain</i>	$V_{DS} = 20\text{ V}$ $V_{GS} = 0$	$I_{DSS}^*$	2N 4091, A 2N 4092, A 2N 4093, A	30 15 8			$\text{mA}$ $\text{mA}$ $\text{mA}$
Gate source cut-off voltage <i>Tension grille source de blocage</i>	$V_{DS} = 20\text{ V}$ $I_D = 1\text{ nA}$	$V_{GSoff}$	2N 4091, A 2N 4092, A 2N 4093, A	-5 -2 -1		-10 -7 -5	V V V

\* pulsed  
 \* *impulsion*  $t_p < 300\text{ }\mu\text{s}$   $\delta < 2\%$

**STATIC CHARACTERISTICS**  
**CARACTERISTIQUES STATIQUES**
 $T_{amb} = 25^{\circ}C$ (Unless otherwise stated)  
(Sauf indications contraires)

	Test conditions <i>Conditions de mesure</i>			Min.	Typ.	Max.	
Drain source saturation voltage <i>Tension de saturation drain source</i>	$V_{GS} = 0$ $I_D = 6,6 \text{ mA}$	$V_{DS \text{ sat}}$	2N 4091, A		0,2		V
	$V_{GS} = 0$ $I_D = 4 \text{ mA}$	$V_{DS \text{ sat}}$	2N 4092, A		0,2		V
	$V_{GS} = 0$ $I_D = 2,5 \text{ mA}$	$V_{DS \text{ sat}}$	2N 4093, A		0,2		V
On state drain source resistance <i>Résistance drain source à l'état passant</i>	$V_{GS} = 0$ $I_D = 1 \text{ mA}$	$r_{DS \text{ on}}$	2N 4091, A 2N 4092, A 2N 4093, A		30 50 80		$\Omega$ $\Omega$ $\Omega$

**DYNAMIC CHARACTERISTICS (for small signals)**  
**CARACTERISTIQUES DYNAMIQUES (pour petits signaux)**

On state drain source resistance <i>Résistance drain source à l'état passant</i>	$V_{GS} = 0$ $I_D = 0$ $f = 1 \text{ kHz}$	$r_{ds \text{ on}}$	2N 4091, A 2N 4092, A 2N 4093, A		30 50 80		$\Omega$ $\Omega$ $\Omega$
Input capacitance <i>Capacité d'entrée</i>	$V_{GS} = 0$ $f = 1 \text{ MHz}$ $V_{DS} = 0$	$C_{11ss}$	2N 4091, A 2N 4092, A 2N 4093, A		28		pF
	$V_{GS} = 0$ $f = 1 \text{ MHz}$ ( $V_{DS} = 20 \text{ V}^*$ )	$C_{11ss}$	2N 4091, A 2N 4092, A 2N 4093, A		(16*)		pF
Reverse transfer capacitance <i>Capacité de transfert inverse</i>	$V_{DS} = 0$ $V_{GS} = -20 \text{ V}$ $f = 1 \text{ MHz}$	$C_{12ss}$	2N 4091, A 2N 4092, A 2N 4093, A		5		pF

\* Indicates JEDEC registered data  
*Valeurs d'origine JEDEC pour information*

SWITCHING CHARACTERISTICS  
CARACTERISTIQUES DE COMMUTATION $T_{amb} = 25^{\circ} C$ (Unless otherwise stated)  
(Sauf indications contraires)

	Test conditions Conditions de mesure			Min.	Typ.	Max.	
Turn-on delay time <i>Retard à la croissance</i>		$t_{d(on)}$	2N 4091, A		15		ns
Rise time <i>Temps de croissance</i>	$V_{DD} = 3 V$ $V_{GS on} = 0$ $V_{GSX} = -12 V$ $I_{D on} \approx 6,6 mA$	$t_r$	2N 4091, A		10		ns
Turn-off time <i>Temps total de décroissance</i>		$t_{off}$	2N 4091, A		40		ns
Turn-on delay time <i>Retard à la croissance</i>		$t_{d(on)}$	2N 4092, A		15		ns
Rise time <i>Temps de croissance</i>	$V_{DD} = 3 V$ $V_{GS on} = 0$ $V_{GSX} = -8 V$ $I_{D on} \approx 4 mA$	$t_r$	2N 4092, A		20		ns
Turn-off time <i>Temps total de décroissance</i>		$t_{off}$	2N 4092, A		60		ns
Turn-on delay time <i>Retard à la croissance</i>		$t_{d(on)}$	2N 4093, A		20		ns
Rise time <i>Temps de croissance</i>	$V_{DD} = 3 V$ $V_{GS on} = 0$ $V_{GSX} = -6 V$ $I_{D on} \approx 2,5 mA$	$t_r$	2N 4093, A		40		ns
Turn off time <i>Temps total de décroissance</i>		$t_{off}$	2N 4093, A		80		ns

**SWITCHING TIMES TESTS CIRCUITS**  
**SCHEMAS DE MESURES DES TEMPS DE COMMUTATION**

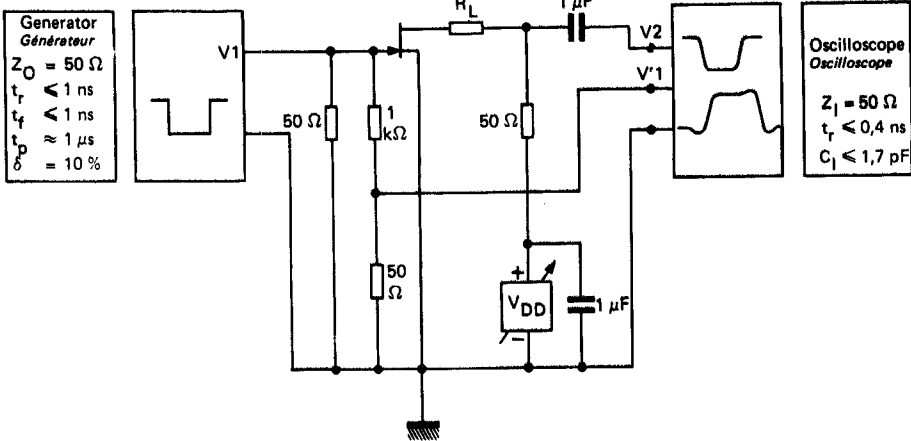

Generator  
 Générateur  
 $Z_0 = 50 \Omega$   
 $t_r \leq 1 \text{ ns}$   
 $t_f \leq 1 \text{ ns}$   
 $R \approx 1 \mu\text{s}$   
 $\delta_{\text{D}} = 10 \%$

Oscilloscope  
 Oscilloscope  
 $Z_1 = 50 \Omega$   
 $t_r \leq 0,4 \text{ ns}$   
 $C_1 \leq 1,7 \text{ pF}$

$V_{GSX}$      - 12 V (2N 4091, A)  
               - 8 V (2N 4092, A)  
               - 6 V (2N 4093, A)

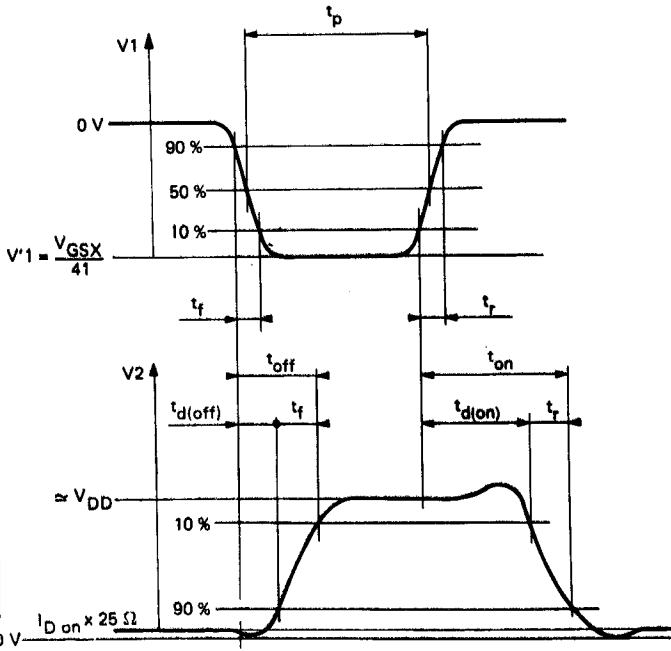

$I_{D \text{ on}}$      $\approx 6,6 \text{ mA}$  (2N 4091, A)  
                $\approx 4 \text{ mA}$  (2N 4092, A)  
                $\approx 2,5 \text{ mA}$  (2N 4093, A)

**STATIC CHARACTERISTICS**  
*CARACTERISTIQUES STATIQUES*

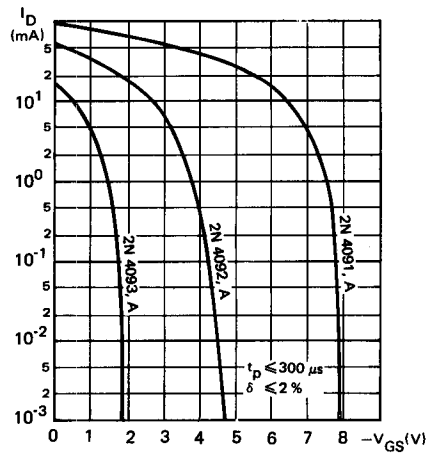
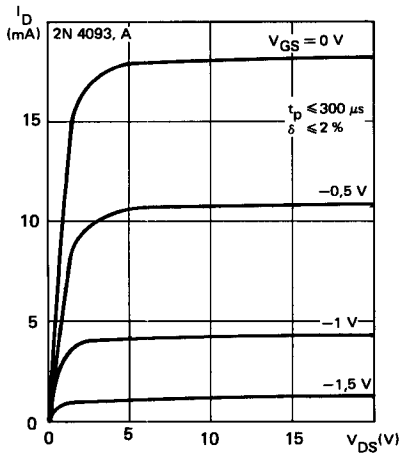
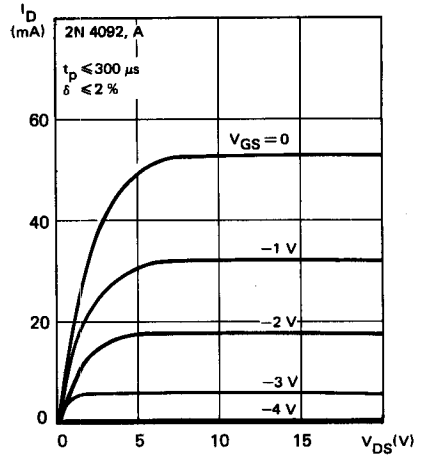
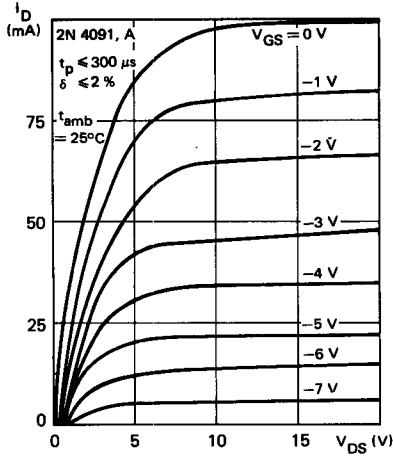

**DYNAMIC CHARACTERISTICS**  
*CARACTERISTIQUES DYNAMIQUES*

