

LP5990

LP5990 Micropower 200mA CMOS Low Dropout Voltage Regulator

Datasheet.Directory



Literature Number: SNVS438B

LP5990

Micropower 200mA CMOS Low Dropout Voltage Regulator

General Description

The LP5990 regulator is designed to meet the requirements of portable, battery-powered systems providing an accurate output voltage, low noise and low quiescent current.

The LP5990 will provide a 1.8V output from a low input voltage of 2.2V and can provide 200mA to an external load.

When switched into shutdown mode via a logic signal at the enable pin, the power consumption is reduced to virtually zero.

Fast shut-down is achieved by the push pull architecture.

The LP5990 is designed to be stable with space saving 0402 ceramic capacitors as small as 1 μ F, this gives an overall solution size of < 2.5mm².

Performance is specified for a -40°C to 125°C junction temperature range.

The device is available in micro SMD Package (0.4mm pitch) and is available with 1.2V, 1.3V, 1.8V, 2.8V, 3.0V, 3.3V and 3.6V outputs. Lower voltage options down to 0.8V are available on request. For all other output voltage options please contact your local NSC sales office.

Features

- Operation from 2.2V to 5.5V input
- $\pm 1\%$ accuracy over temp range
- Output voltage from 0.8V to 3.6V in 50mV increments
- 30 μ A Quiescent current (enabled)
- 10nA Quiescent current (disabled)
- 160mV dropout at 200mA load
- 60 μ V_{RMS} Output voltage noise
- 60 μ s start-up time
- 500 μ s shut-down time
- PSRR 55 dB at 10 kHz
- Stable with 0402 1.0 μ F ceramic capacitors
- Logic controlled enable
- Thermal-overload and short-circuit protection

Package

4-Bump micro SMD, 0.4mm pitch
(lead free)

866 μ m x 917 μ m

Applications

- Cellular phones
- Hand-held information appliances

Typical Application Circuit

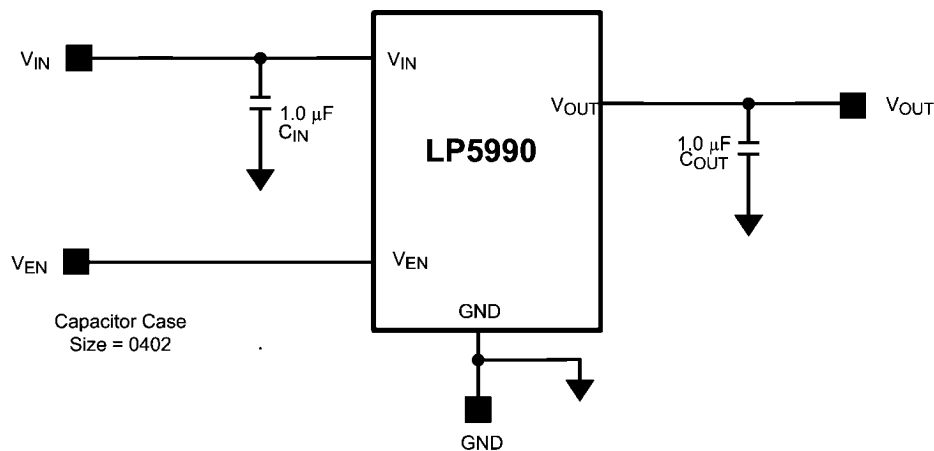

20184801

Connection Diagrams

4-Bump Thin micro SMD Package, 0.4mm pitch
NS Package Number TMD04

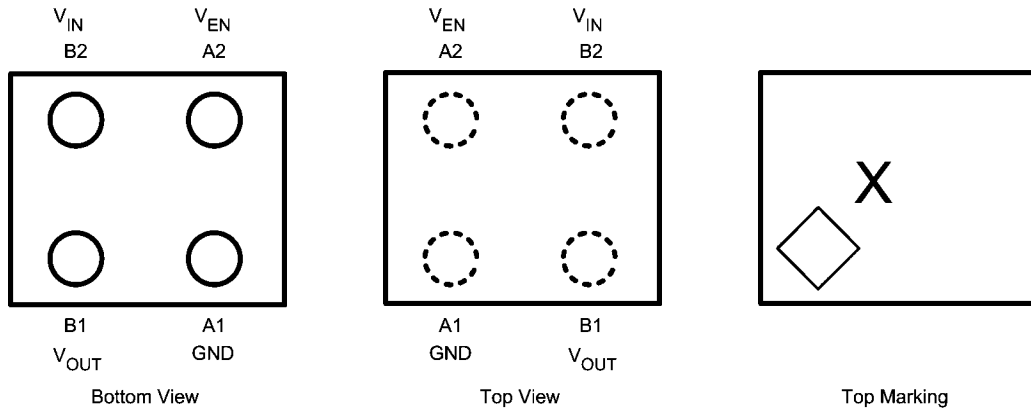

20184802

The actual physical placement of the package marking will vary from part to part.

Pin Descriptions

Pin No.	Symbol	Name and Function
micro SMD		
A2	V_{EN}	Enable input; disables the regulator when $\leq 0.35V$. Enables the regulator when $\geq 1.0V$.
A1	GND	Common ground.
B1	V_{OUT}	Output voltage. A $1.0 \mu F$ Low ESR capacitor should be connected to this Pin. Connect this output to the load circuit.
B2	V_{IN}	Input voltage supply. A $1.0 \mu F$ capacitor should be connected at this input.

Ordering Information

micro SMD Package (Lead Free)

Output Voltage (V)	Supplied As	
	250 Units Tape and Reel	3k Units Tape and Reel
1.2	LP5990TM-1.2/NOPB	LP5990TMX-1.2/NOPB
1.3	LP5990TM-1.3/NOPB	LP5990TMX-1.3/NOPB
1.8	LP5990TM-1.8/NOPB	LP5990TMX-1.8/NOPB
2.8	LP5990TM-2.8/NOPB	LP5990TMX-2.8/NOPB
3.0	LP5990TM-3.0/NOPB	LP5990TMX-3.0/NOPB
3.3	LP5990TM-3.3/NOPB	LP5990TMX-3.3/NOPB
3.6	LP5990TM-3.6/NOPB	LP5990TMX-3.6/NOPB

Absolute Maximum Ratings (Notes 1, 2)

If Military/Aerospace specified devices are required, please contact the National Semiconductor Sales Office/Distributors for availability and specifications.

V_{IN} Pin: Input Voltage	-0.3 to 6.0V
V_{OUT} Pin: Output Voltage	-0.3 to ($V_{IN} + 0.3V$) to 6.0V (max)
V_{EN} Pin: Enable Input Voltage	-0.3 to 6.0V (max)
Continuous Power Dissipation (Note 3)	Internally Limited
Junction Temperature (T_{JMAX})	150°C
Storage Temperature Range	-65 to 150°C
Maximum Lead Temperature (Soldering, 10 sec.)	260°C
ESD Rating (Note 4)	

Human Body Model	2 kV
Machine Model	200V

Operating Ratings (Note 1), (Note 2)

V_{IN} : Input Voltage Range	2.2V to 5.5V
V_{EN} : Enable Voltage Range	0 to 5.5V (max)
Recommended Load Current (Note 5)	0 to 200 mA
Junction Temperature Range (T_J)	-40°C to +125°C
Ambient Temperature Range (T_A) (Note 5)	-40°C to +85°C

Thermal Properties

Junction to Ambient Thermal Resistance θ_{JA} (Note 6)	
JEDEC Board (microSMD) (Note 14)	100.6°C/W
4L Cellphone Board (microSMD)	174.8°C/W

Electrical Characteristics

Limits in standard typeface are for $T_A = 25^\circ\text{C}$. Limits in **boldface** type apply over the full operating junction temperature range (-40°C $\leq T_J \leq +125^\circ\text{C}$). Unless otherwise noted, specifications apply to the LP5990 Typical Application Circuit (pg. 1) with: $V_{IN} = V_{OUT(NOM)} + 1.0V$, or 2.2V, whichever is higher. $V_{EN} = 1.0V$, $C_{IN} = C_{OUT} = 1.0 \mu\text{F}$, $I_{OUT} = 1.0 \text{ mA}$. (Note 2), (Note 7)

Symbol	Parameter	Conditions	Min	Typ	Max	Units
V_{IN}	Input Voltage		2.2		5.5	V
ΔV_{OUT}	Output Voltage Tolerance	$V_{IN} = (V_{OUT(NOM)} + 1.0V)$ to 5.5V	-1		1	%
	Line Regulation	$V_{IN} = (V_{OUT(NOM)} + 1.0V)$ to 5.5V, $I_{OUT} = 1 \text{ mA}$		1		mV
	Load Regulation	$I_{OUT} = 1 \text{ mA}$ to 200 mA		5	15	mV
I_{LOAD}	Load Current	(Note 8)	0			mA
	Maximum Output Current		200			
I_Q	Quiescent Current (Note 10)	$V_{EN} = 1.0V$, $I_{OUT} = 0 \text{ mA}$		30	75	μA
		$V_{EN} = 1.0V$, $I_{OUT} = 200 \text{ mA}$		35		
		$V_{EN} = <0.35V$ (Disabled)		0.01		
V_{DO}	Dropout Voltage (Note 9)	$I_{OUT} = 200 \text{ mA}$		160	250	mV
I_{SC}	Short Circuit Current Limit	(Note 11)		600		mA
PSRR	Power Supply Rejection Ratio (Note 13)	$f = 10 \text{ kHz}$, $I_{OUT} = 200 \text{ mA}$		55		dB
e_n	Output Noise Voltage (Note 13)	BW = 10 Hz to 100 kHz, $V_{IN} = 4.2V$, $I_{OUT} = 1 \text{ mA}$	$V_{OUT} = 1.8V$		60	μV_{RMS}
			$V_{OUT} = 2.8V$		85	
$T_{SHUTDOWN}$	Thermal Shutdown	Temperature		160		°C
		Hysteresis		20		

Electrical Characteristics (continued).

Limits in standard typeface are for $T_A = 25^\circ\text{C}$. Limits in **boldface** type apply over the full operating junction temperature range ($-40^\circ\text{C} \leq T_J \leq +125^\circ\text{C}$). Unless otherwise noted, specifications apply to the LP5990 Typical Application Circuit (pg. 1) with: $V_{IN} = V_{OUT(NOM)} + 1.0\text{V}$, or 2.2V , whichever is higher. $V_{EN} = 1.0\text{V}$, $C_{IN} = C_{OUT} = 1.0\ \mu\text{F}$, $I_{OUT} = 1.0\ \text{mA}$. (Note 2), (Note 7)

Symbol	Parameter	Conditions	Min	Typ	Max	Units
Enable Input Thresholds						
V_{IL}	Low Input Threshold (V_{EN})	$V_{IN} = 2.2\text{V to } 5.5\text{V}$			0.35	V
V_{IH}	High Input Threshold (V_{EN})	$V_{IN} = 2.2\text{V to } 5.5\text{V}$	1.0			V
I_{EN}	Input Current at V_{EN} Pin (Note 12)	$V_{EN} = 5.5\text{V}$ and $V_{IN} = 5.5\text{V}$		2	5	μA
		$V_{EN} = 0.0\text{V}$ and $V_{IN} = 5.5\text{V}$		0.001		
Transient Characteristics						
ΔV_{OUT}	Line Transient (Note 13)	$T_{rise} = T_{fall} = 30\ \mu\text{s}$. $\Delta V_{IN} = 600\ \text{mV}$		4		mV
	Load Transient (Note 13)	$I_{OUT} = 1\ \text{mA to } 200\ \text{mA}$ in $1\ \mu\text{s}$ $I_{OUT} = 200\ \text{mA to } 1\ \text{mA}$ in $1\ \mu\text{s}$		-50		mV
T_{ON}	Turn on Time	To 98% of $V_{OUT(NOM)}$		60		μs
T_{OFF}	Turn off Time from Enable	100mV of $V_{OUT(NOM)}$ $I_{OUT} = 0\text{mA}$		500		μs

Note 1: Absolute Maximum Ratings indicate limits beyond which damage to the component may occur. Operating Ratings are conditions under which operation of the device is guaranteed. Operating Ratings do not imply guaranteed performance limits. For guaranteed performance limits and associated test conditions, see the Electrical Characteristics tables.

Note 2: All voltages are with respect to the potential at the GND pin.

Note 3: Internal thermal shutdown circuitry protects the device from permanent damage.

Note 4: The Human body model is a $100\ \text{pF}$ capacitor discharged through a $1.5\ \text{k}\Omega$ resistor into each pin. The machine model is a $200\ \text{pF}$ capacitor discharged directly into each pin. MIL-STD-883 3015.7

Note 5: In applications where high power dissipation and/or poor package thermal resistance is present, the maximum ambient temperature may have to be derated. Maximum ambient temperature (T_{A-MAX}) is dependent on the maximum operating junction temperature ($T_{J-MAX-OP} = 125^\circ\text{C}$), the maximum power dissipation of the device in the application (P_{D-MAX}), and the junction-to ambient thermal resistance of the part/package in the application (θ_{JA}), as given by the following equation: $T_{A-MAX} = T_{J-MAX-OP} - (\theta_{JA} \times P_{D-MAX})$. See applications section.

Note 6: Junction-to-ambient thermal resistance is highly application and board-layout dependent. In applications where high maximum power dissipation exists, special care must be paid to thermal dissipation issues in board design.

Note 7: Min and Max limits are guaranteed by design, test, or statistical analysis. Typical numbers are not guaranteed, but do represent the most likely norm.

Note 8: The device maintains a stable, regulated output voltage without a load current.

Note 9: Dropout voltage is the voltage difference between the input and the output at which the output voltage drops to $100\ \text{mV}$ below its nominal value. This parameter only applies to output voltages above 2.8V .

Note 10: Quiescent current is defined here as the difference in current between the input voltage source and the load at V_{OUT} .

Note 11: Short Circuit Current is measured with V_{OUT} pulled to 0V .

Note 12: There is a $3\ \text{M}\Omega$ resistor between V_{EN} and ground on the device.

Note 13: This specification is guaranteed by design.

Note 14: Detailed description of the board can be found in JESD51-7

Output & Input Capacitor, Recommended Specifications

Symbol	Parameter	Conditions	Min	Nom	Max	Units
C_{IN}	Input Capacitance	Capacitance for stability	0.3	1.0		μF
C_{OUT}	Output Capacitance		0.3	1.0	10	
ESR	Output/Input Capacitance		5		500	$\text{m}\Omega$

Note: The minimum capacitance should be greater than $0.3\ \mu\text{F}$ over the full range of operating conditions. The capacitor tolerance should be 30% or better over the full temperature range. The full range of operating conditions for the capacitor in the application should be considered during device selection to ensure this minimum capacitance specification is met. X7R capacitors are recommended however capacitor types X5R, Y5V and Z5U may be used with consideration of the application and conditions.

Typical Performance Characteristics. Unless otherwise specified, $C_{IN} = C_{OUT} = 1.0\mu F$, $V_{IN} = V_{OUT(NOM)} + 1.0V$, $V_{EN} = 1.0V$, $I_{OUT} = 1mA$, $T_A = 25^\circ C$.

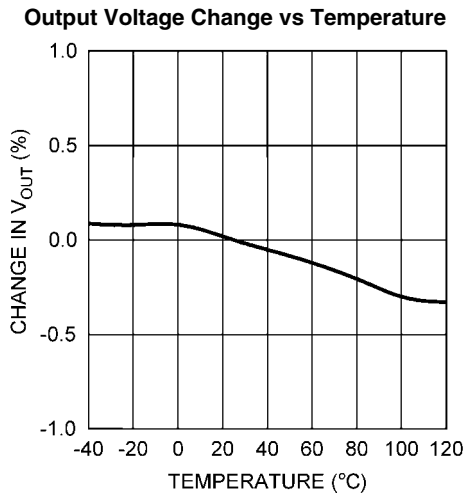

20184899

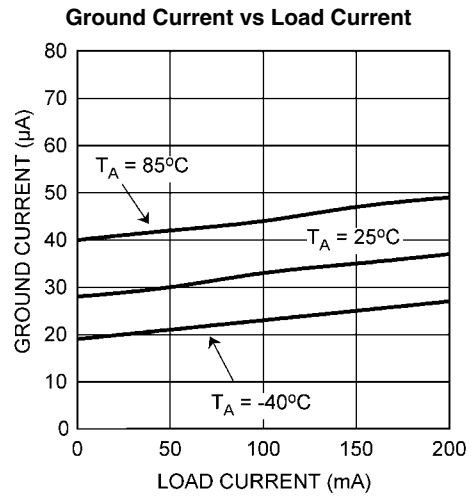

20184843

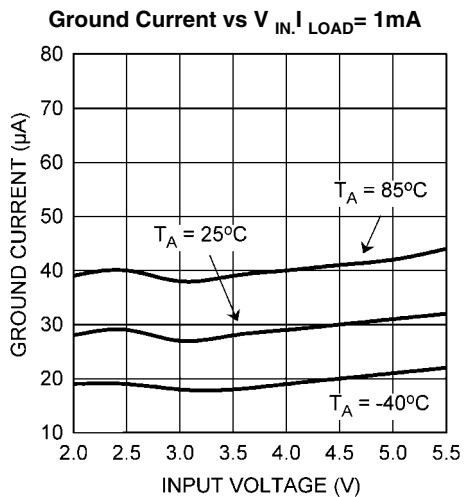

20184854

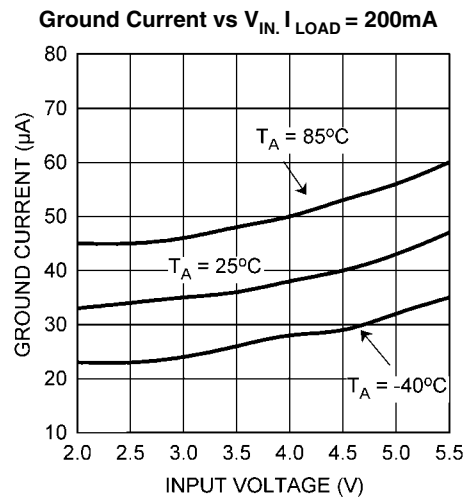

20184851

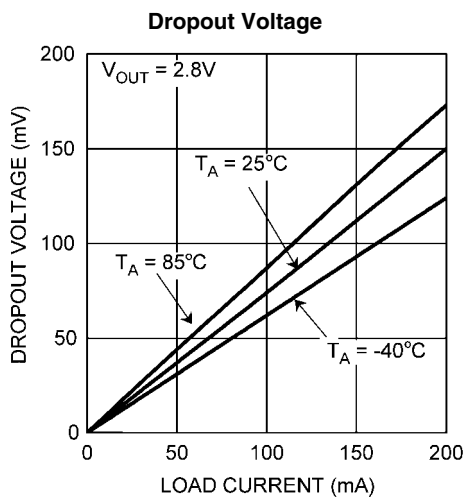

20184899

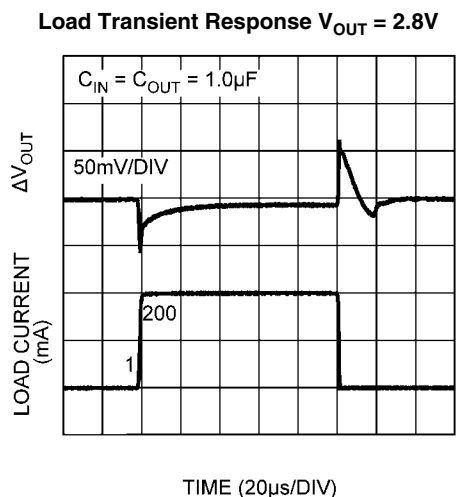

20184887

Typical Performance Characteristics (continued). Unless otherwise specified, $C_{IN} = C_{OUT} = 1.0\mu F$, $V_{IN} = V_{OUT(NOM)} + 1.0V$, $V_{EN} = 1.0V$, $I_{OUT} = 1mA$, $T_A = 25^\circ C$.

Load Transient Response. $V_{OUT} = 2.8V$

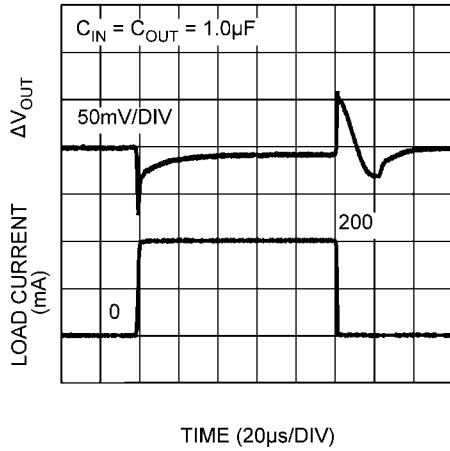

20184886

Short Circuit Current

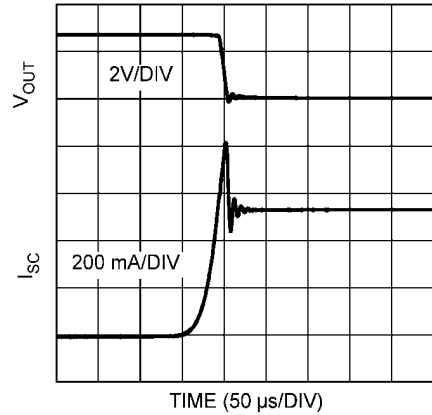

20184888

Line Transient Response

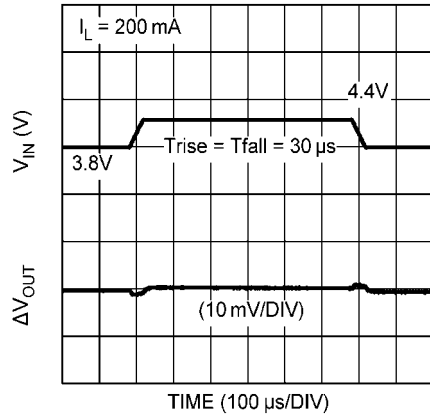

20184895

Line Transient Response

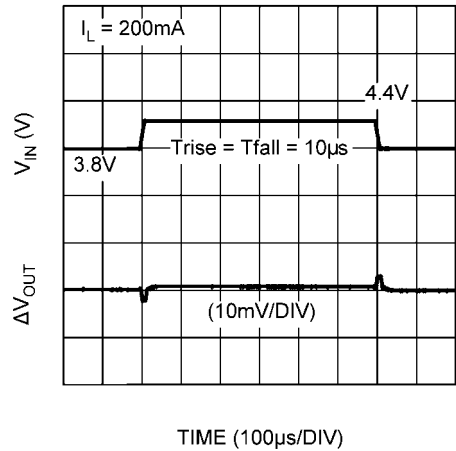

20184885

Start-up Time

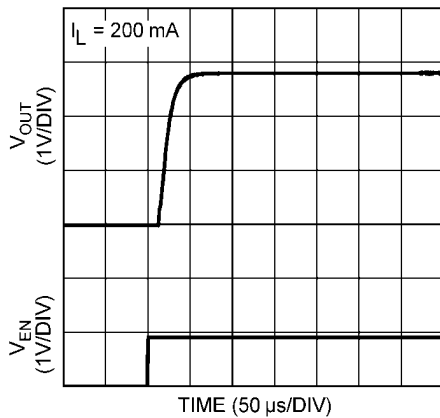

20184893

Shutdown Characteristics

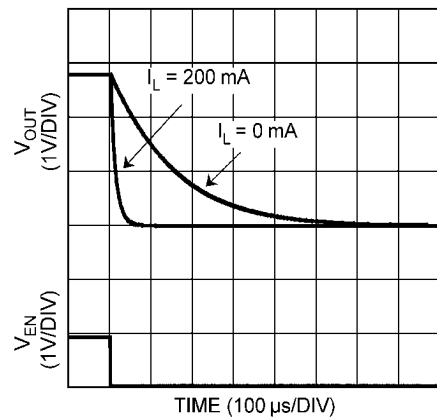

20184890

Typical Performance Characteristics (continued). Unless otherwise specified, $C_{IN} = C_{OUT} = 1.0\mu F$, $V_{IN} = V_{OUT(NOM)} + 1.0V$, $V_{EN} = 1.0V$, $I_{OUT} = 1mA$, $T_A = 25^\circ C$.

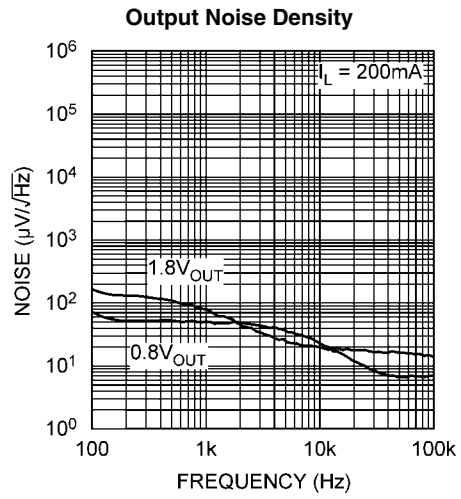
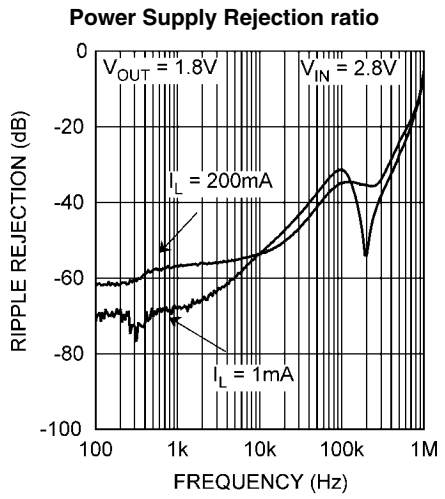

Application Hints

POWER DISSIPATION AND DEVICE OPERATION

The permissible power dissipation for any package is a measure of the capability of the device to pass heat from the power source, the junctions of the IC, to the ultimate heat sink, the ambient environment. Thus the power dissipation is dependent on the ambient temperature and the thermal resistance across the various interfaces between the die and ambient air. As stated in (Note 5) of the electrical characteristics, the allowable power dissipation for the device in a given package can be calculated using the equation:

$$P_D = \frac{(T_{JMAX} - T_A)}{\theta_{JA}}$$

The actual power dissipation across the device can be represented by the following equation:

$$P_D = (V_{IN} - V_{OUT}) \times I_{OUT}$$

This establishes the relationship between the power dissipation allowed due to thermal consideration, the voltage drop across the device, and the continuous current capability of the device. These two equations should be used to determine the optimum operating conditions for the device in the application.

EXTERNAL CAPACITORS

Like any low-dropout regulator, the LP5990 requires external capacitors for regulator stability. The LP5990 is specifically designed for portable applications requiring minimum board space and smallest components. These capacitors must be correctly selected for good performance.

INPUT CAPACITOR

An input capacitor is required for stability. The input capacitor should be at least equal to or greater than the output capacitor. It is recommended that a 1.0 μ F capacitor be connected between the LP5990 input pin and ground.

This capacitor must be located a distance of not more than 1 cm from the input pin and returned to a clean analogue ground. Any good quality ceramic, tantalum, or film capacitor may be used at the input.

Important: To ensure stable operation it is essential that good PCB practices are employed to minimize ground impedance and keep input inductance low. If these conditions cannot be met, or if long leads are to be used to connect the battery or other power source to the LP5990, then it is recommended to increase the input capacitor to at least 2.2 μ F. Also, tantalum capacitors can suffer catastrophic failures due to surge current when connected to a low-impedance source of power (like a battery or a very large capacitor). If a tantalum capacitor is used at the input, it must be guaranteed by the manufacturer to have a surge current rating sufficient for the application. There are no requirements for the ESR (Equivalent Series Resistance) on the input capacitor, but tolerance and temperature coefficient must be considered when selecting the capacitor to ensure the capacitance will remain 0.3 μ F over the entire operating temperature range.

OUTPUT CAPACITOR

The LP5990 is designed specifically to work with very small ceramic output capacitors. A ceramic capacitor (dielectric types X5R or X7R) 1.0 μ F, and with ESR between 5 m Ω to 500 m Ω , is suitable in the LP5990 application circuit.

Other ceramic capacitors such as Y5V and Z5U are less suitable owing to their inferior temperature characteristics. (See section in Capacitor Characteristics).

For this device the output capacitor should be connected between the V_{OUT} pin and a good ground connection and should be mounted within 1 cm of the device.

It may also be possible to use tantalum or film capacitors at the device output, V_{OUT} , but these are not as attractive for reasons of size and cost (see the section Capacitor Characteristics).

The output capacitor must meet the requirement for the minimum value of capacitance (0.3 μ F) and have an ESR value that is within the range 5 m Ω to 500 m Ω for stability.

CAPACITOR CHARACTERISTICS

The LP5990 is designed to work with ceramic capacitors on the input and output to take advantage of the benefits they offer. For capacitance values in the range of 1.0 μ F to 4.7 μ F, ceramic capacitors are the smallest, least expensive and have the lowest ESR values, thus making them best for eliminating high frequency noise. The ESR of a typical 1.0 μ F ceramic capacitor is in the range of 20 m Ω to 40 m Ω , which easily meets the ESR requirement for stability for the LP5990. For both input and output capacitors careful interpretation of the capacitor specification is required to ensure correct device operation. The capacitor value can change greatly depending on the conditions of operation and capacitor type.

In particular the output capacitor selection should take account of all the capacitor parameters to ensure that the specification is met within the application. Capacitance value can vary with DC bias conditions as well as temperature and frequency of operation. Capacitor values will also show some decrease over time due to aging. The capacitor parameters are also dependant on particular case size with smaller sizes giving poorer performance figures in general. As an example *Figure 1* shows a typical graph showing a comparison of capacitor case sizes in a Capacitance versus DC Bias plot. As shown in the graph, as a result of the DC Bias condition, the capacitance value may drop below the minimum capacitance value given in the recommended capacitor table (0.3 μ F in this case). Note that the graph shows the capacitance out of spec for the 0402 case size capacitor at higher bias voltages. It is therefore recommend that the capacitor manufacturer's specifications for the nominal value capacitor are consulted for all conditions as some capacitors may not be suited in the application.

The temperature performance of ceramic capacitors varies by type and manufacturer. Most large value ceramic capacitors (≥ 2.2 μ F) are manufactured with Z5U or Y5V temperature characteristics, which results in the capacitance dropping by more than 50% as the temperature goes from 25°C to 85°C. A better choice for temperature coefficient in a ceramic capacitor is X7R. This type of capacitor is the most stable and holds the capacitance within $\pm 15\%$ over the temperature range. Tantalum capacitors are less desirable than ceramic for use as output capacitors because they are more expensive when comparing equivalent capacitance and voltage ratings in the 0.47 μ F to 4.7 μ F range.

Another important consideration is that tantalum capacitors have higher ESR values than equivalent size ceramics. This means that while it may be possible to find a tantalum capacitor with an ESR value within the stable range, it would have to be larger in capacitance (which means bigger and more costly) than a ceramic capacitor with the same ESR value. It should also be noted that the ESR of a typical tantalum will

increase about 2:1 as the temperature goes from 25°C down to -40°C, so some guard band must be allowed.

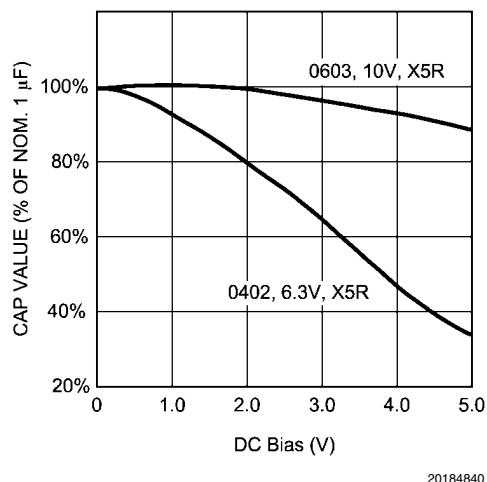

FIGURE 1. Graph Showing a Typical Variation in Capacitance vs DC Bias

NO-LOAD STABILITY

The LP5990 will remain stable and in regulation with no external load.

ENABLE CONTROL

The LP5990 may be switched ON or OFF by a logic input at the ENABLE pin, V_{EN} . A high voltage at this pin will turn the

device on. When the enable pin is low, the regulator output is off and the device typically consumes 3 nA. If the application does not require the shutdown feature, the V_{EN} pin should be tied to V_{IN} to keep the regulator output permanently on.

The signal source used to drive the V_{EN} input must be able to swing above and below the specified turn-on/off voltage thresholds listed in the Electrical Characteristics section under V_{IL} and V_{IH} .

micro SMD MOUNTING

The micro SMD package requires specific mounting techniques, which are detailed in National Semiconductor Application Note AN-1112.

For best results during assembly, alignment ordinals on the PC board may be used to facilitate placement of the micro SMD device.

micro SMD LIGHT SENSITIVITY

Exposing the micro SMD device to direct light may cause incorrect operation of the device. Light sources such as halogen lamps can affect electrical performance if they are situated in proximity to the device.

Light with wavelengths in the red and infra-red part of the spectrum have the most detrimental effect thus the fluorescent lighting used inside most buildings has very little effect on performance.

Physical Dimensions inches (millimeters) unless otherwise noted

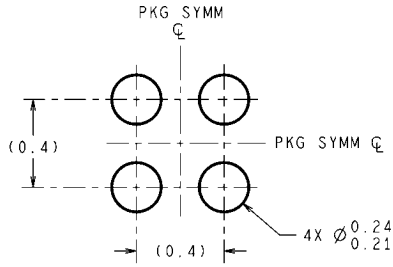

DIMENSIONS ARE IN MILLIMETERS
 DIMENSIONS IN () FOR REFERENCE ONLY

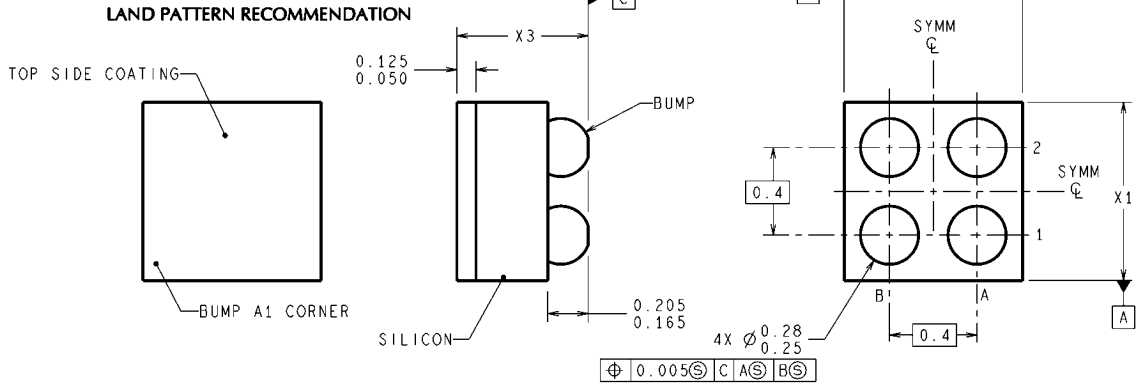

TMD04XXX (Rev A)

4-Bump Thin micro SMD
NS Package Number TMD04 CEA
The dimensions for X1, X2 and X3 are given as:
X1 = 0.866 mm \pm 0.030 mm
X2 = 0.917 mm \pm 0.030 mm
X3 = 0.600 mm \pm 0.075 mm

Notes

LP5990

Notes

For more National Semiconductor product information and proven design tools, visit the following Web sites at:

Products		Design Support	
Amplifiers	www.national.com/amplifiers	WEBENCH	www.national.com/webench
Audio	www.national.com/audio	Analog University	www.national.com/AU
Clock Conditioners	www.national.com/timing	App Notes	www.national.com/appnotes
Data Converters	www.national.com/adc	Distributors	www.national.com/contacts
Displays	www.national.com/displays	Green Compliance	www.national.com/quality/green
Ethernet	www.national.com/ethernet	Packaging	www.national.com/packaging
Interface	www.national.com/interface	Quality and Reliability	www.national.com/quality
LVDS	www.national.com/lvds	Reference Designs	www.national.com/refdesigns
Power Management	www.national.com/power	Feedback	www.national.com/feedback
Switching Regulators	www.national.com/switchers		
LDOs	www.national.com/ldo		
LED Lighting	www.national.com/led		
PowerWise	www.national.com/powerwise		
Serial Digital Interface (SDI)	www.national.com/sdi		
Temperature Sensors	www.national.com/tempsensors		
Wireless (PLL/VCO)	www.national.com/wireless		

THE CONTENTS OF THIS DOCUMENT ARE PROVIDED IN CONNECTION WITH NATIONAL SEMICONDUCTOR CORPORATION ("NATIONAL") PRODUCTS. NATIONAL MAKES NO REPRESENTATIONS OR WARRANTIES WITH RESPECT TO THE ACCURACY OR COMPLETENESS OF THE CONTENTS OF THIS PUBLICATION AND RESERVES THE RIGHT TO MAKE CHANGES TO SPECIFICATIONS AND PRODUCT DESCRIPTIONS AT ANY TIME WITHOUT NOTICE. NO LICENSE, WHETHER EXPRESS, IMPLIED, ARISING BY ESTOPPEL OR OTHERWISE, TO ANY INTELLECTUAL PROPERTY RIGHTS IS GRANTED BY THIS DOCUMENT.

TESTING AND OTHER QUALITY CONTROLS ARE USED TO THE EXTENT NATIONAL DEEMS NECESSARY TO SUPPORT NATIONAL'S PRODUCT WARRANTY. EXCEPT WHERE MANDATED BY GOVERNMENT REQUIREMENTS, TESTING OF ALL PARAMETERS OF EACH PRODUCT IS NOT NECESSARILY PERFORMED. NATIONAL ASSUMES NO LIABILITY FOR APPLICATIONS ASSISTANCE OR BUYER PRODUCT DESIGN. BUYERS ARE RESPONSIBLE FOR THEIR PRODUCTS AND APPLICATIONS USING NATIONAL COMPONENTS. PRIOR TO USING OR DISTRIBUTING ANY PRODUCTS THAT INCLUDE NATIONAL COMPONENTS, BUYERS SHOULD PROVIDE ADEQUATE DESIGN, TESTING AND OPERATING SAFEGUARDS.

EXCEPT AS PROVIDED IN NATIONAL'S TERMS AND CONDITIONS OF SALE FOR SUCH PRODUCTS, NATIONAL ASSUMES NO LIABILITY WHATSOEVER, AND NATIONAL DISCLAIMS ANY EXPRESS OR IMPLIED WARRANTY RELATING TO THE SALE AND/OR USE OF NATIONAL PRODUCTS INCLUDING LIABILITY OR WARRANTIES RELATING TO FITNESS FOR A PARTICULAR PURPOSE, MERCHANTABILITY, OR INFRINGEMENT OF ANY PATENT, COPYRIGHT OR OTHER INTELLECTUAL PROPERTY RIGHT.

LIFE SUPPORT POLICY

NATIONAL'S PRODUCTS ARE NOT AUTHORIZED FOR USE AS CRITICAL COMPONENTS IN LIFE SUPPORT DEVICES OR SYSTEMS WITHOUT THE EXPRESS PRIOR WRITTEN APPROVAL OF THE CHIEF EXECUTIVE OFFICER AND GENERAL COUNSEL OF NATIONAL SEMICONDUCTOR CORPORATION. As used herein:

Life support devices or systems are devices which (a) are intended for surgical implant into the body, or (b) support or sustain life and whose failure to perform when properly used in accordance with instructions for use provided in the labeling can be reasonably expected to result in a significant injury to the user. A critical component is any component in a life support device or system whose failure to perform can be reasonably expected to cause the failure of the life support device or system or to affect its safety or effectiveness.

National Semiconductor and the National Semiconductor logo are registered trademarks of National Semiconductor Corporation. All other brand or product names may be trademarks or registered trademarks of their respective holders.

Copyright© 2007 National Semiconductor Corporation

For the most current product information visit us at www.national.com



National Semiconductor Americas Customer Support Center
 Email: new.feedback@nsc.com
 Tel: 1-800-272-9959

National Semiconductor Europe Customer Support Center
 Fax: +49 (0) 180-530-85-86
 Email: europe.support@nsc.com
 Deutsch Tel: +49 (0) 69 9508 6208
 English Tel: +49 (0) 870 24 0 2171
 Français Tel: +33 (0) 1 41 91 8790

National Semiconductor Asia Pacific Customer Support Center
 Email: ap.support@nsc.com

National Semiconductor Japan Customer Support Center
 Fax: 81-3-5639-7507
 Email: jpn.feedback@nsc.com
 Tel: 81-3-5639-7560

IMPORTANT NOTICE

Texas Instruments Incorporated and its subsidiaries (TI) reserve the right to make corrections, modifications, enhancements, improvements, and other changes to its products and services at any time and to discontinue any product or service without notice. Customers should obtain the latest relevant information before placing orders and should verify that such information is current and complete. All products are sold subject to TI's terms and conditions of sale supplied at the time of order acknowledgment.

TI warrants performance of its hardware products to the specifications applicable at the time of sale in accordance with TI's standard warranty. Testing and other quality control techniques are used to the extent TI deems necessary to support this warranty. Except where mandated by government requirements, testing of all parameters of each product is not necessarily performed.

TI assumes no liability for applications assistance or customer product design. Customers are responsible for their products and applications using TI components. To minimize the risks associated with customer products and applications, customers should provide adequate design and operating safeguards.

TI does not warrant or represent that any license, either express or implied, is granted under any TI patent right, copyright, mask work right, or other TI intellectual property right relating to any combination, machine, or process in which TI products or services are used. Information published by TI regarding third-party products or services does not constitute a license from TI to use such products or services or a warranty or endorsement thereof. Use of such information may require a license from a third party under the patents or other intellectual property of the third party, or a license from TI under the patents or other intellectual property of TI.

Reproduction of TI information in TI data books or data sheets is permissible only if reproduction is without alteration and is accompanied by all associated warranties, conditions, limitations, and notices. Reproduction of this information with alteration is an unfair and deceptive business practice. TI is not responsible or liable for such altered documentation. Information of third parties may be subject to additional restrictions.

Resale of TI products or services with statements different from or beyond the parameters stated by TI for that product or service voids all express and any implied warranties for the associated TI product or service and is an unfair and deceptive business practice. TI is not responsible or liable for any such statements.

TI products are not authorized for use in safety-critical applications (such as life support) where a failure of the TI product would reasonably be expected to cause severe personal injury or death, unless officers of the parties have executed an agreement specifically governing such use. Buyers represent that they have all necessary expertise in the safety and regulatory ramifications of their applications, and acknowledge and agree that they are solely responsible for all legal, regulatory and safety-related requirements concerning their products and any use of TI products in such safety-critical applications, notwithstanding any applications-related information or support that may be provided by TI. Further, Buyers must fully indemnify TI and its representatives against any damages arising out of the use of TI products in such safety-critical applications.

TI products are neither designed nor intended for use in military/aerospace applications or environments unless the TI products are specifically designated by TI as military-grade or "enhanced plastic." Only products designated by TI as military-grade meet military specifications. Buyers acknowledge and agree that any such use of TI products which TI has not designated as military-grade is solely at the Buyer's risk, and that they are solely responsible for compliance with all legal and regulatory requirements in connection with such use.

TI products are neither designed nor intended for use in automotive applications or environments unless the specific TI products are designated by TI as compliant with ISO/TS 16949 requirements. Buyers acknowledge and agree that, if they use any non-designated products in automotive applications, TI will not be responsible for any failure to meet such requirements.

Following are URLs where you can obtain information on other Texas Instruments products and application solutions:

Products

Audio	www.ti.com/audio
Amplifiers	amplifier.ti.com
Data Converters	dataconverter.ti.com
DLP® Products	www.dlp.com
DSP	dsp.ti.com
Clocks and Timers	www.ti.com/clocks
Interface	interface.ti.com
Logic	logic.ti.com
Power Mgmt	power.ti.com
Microcontrollers	microcontroller.ti.com
RFID	www.ti-rfid.com
OMAP Mobile Processors	www.ti.com/omap
Wireless Connectivity	www.ti.com/wirelessconnectivity

Applications

Communications and Telecom	www.ti.com/communications
Computers and Peripherals	www.ti.com/computers
Consumer Electronics	www.ti.com/consumer-apps
Energy and Lighting	www.ti.com/energy
Industrial	www.ti.com/industrial
Medical	www.ti.com/medical
Security	www.ti.com/security
Space, Avionics and Defense	www.ti.com/space-avionics-defense
Transportation and Automotive	www.ti.com/automotive
Video and Imaging	www.ti.com/video

TI E2E Community Home Page

e2e.ti.com

Mailing Address: Texas Instruments, Post Office Box 655303, Dallas, Texas 75265
Copyright © 2011, Texas Instruments Incorporated