

1. $\text{\textcircled{C}}$ REPRESENTS A CRITICAL DIMENSION.
2. MINIMUM PUSHOUT FORCE: .5 LB.
3. COPLANARITY: .004[0.10] = POS 05 THRU 26
.006[0.15] = POS 27 THRU 50
4. TUBE ALL POSITIONS. PARTS TO BE TUBED WITH NOTCH GOING WITH ARROW.
5. PINS CAN BE ORIENTED IN ANY DIRECTION; BOTH ROWS MUST FACE SAME WAY.
6. SEE NOTCH FOR PROPER ORIENTATION.
7. MAXIMUM PIN HEIGHT VARIATION: .003[0.08].
8. DUE TO HIGH AMOUNT OF INSERTION FORCE NEEDED, THE -LC OPTION IS NOT COMPATIBLE WITH AUTO PLACEMENT. SAMTEC RECOMMENDS MANUAL PLACEMENT FOR ALL ASSEMBLIES WITH THE -LC OPTION.

DO NOT SCALE FROM THIS PRINT

SFM-1XX-XX-XXX-D-XXX

No OF POSITIONS
ALL POSITIONS AVAILABLE
-02 THRU -50
(USE BODY: SFM-XX-D-XX-X)

- OPTIONS
(LEAVE BLANK FOR STANDARD AND USE SFM-XX-D)
-N: NO POLARIZATION NOTCH (USE SFM-XX-D-XX-N)
-A: ALIGNMENT PIN (USE SFM-XX-D-A-X) (SEE FIG. 4, SHT 2)
-LC: LOCKING CLIP (SEE FIG. 6, SHT. 3 & NOTE 8) (AVAILABLE ON ALL LEADS)
-P: PICK AND PLACE PAD (SEE FIG. 5, SHT 2)
-TR: TAPE & REEL (SEE SHT 4) (NOT AVAILABLE WITH -SD OPTION)
-K: POLYIMIDE FILM PAD (.005[0.13] THICKNESS WITH SILICONE ADHESIVE) (SEE FIG. 3, SHT. 2) (USE K-500-300)
-SN: SOLDER NAIL FOR .062 BOARD (SFM-XX-D-SN AND WT-27-01-T) (AVAILABLE WITH LEAD STYLE -02, -L2 & -T2) (NOT AVAILABLE WITH -A & -LC)
-SN2: SOLDER NAIL FOR .093 BOARD (SFM-XX-D-SN AND WT-27-02-T) (AVAILABLE WITH LEAD STYLE -02, -L2 & -T2) (NOT AVAILABLE WITH -A & -LC)
**SD: SCREW DOWN FOR .062 BOARD (ONLY AVAILABLE WITH -01 & -02 LEAD STYLE) (NOT AVAILABLE WITH OPTIONS -N, -A, -LC, -RA, -SA, -WT, -RE1, -RE2, SN, OR SN2) (SFM-XX-D-SD, CPS-RR-XX-XX-X & ACCRT-01) (SEE FIG. 8, SHT. 3)

(** = NOT RELEASED FOR PRODUCTION)

BODY SPECIFICATION
-D: DOUBLE ROW

PLATING SPECIFICATION $\text{\textcircled{CP}}$

- S: 30 μ " SELECTIVE GOLD IN CONTACT AREA, MATTE TIN ON TAIL
- F: 3 μ " FLASH SELECTIVE GOLD IN CONTACT AREA, MATTE TIN ON TAIL
- H: 30 μ " HEAVY GOLD IN CONTACT AREA, 3 μ " GOLD ON TAIL
- L: 10 μ " LIGHT SELECTIVE GOLD IN CONTACT AREA, MATTE TIN ON TAIL
- STL: 30 μ " SELECTIVE GOLD IN CONTACT AREA, TIN/LEAD (90/10+/-5%) TAIL (ONLY AVAILABLE ON -02 OR -L2 LEADSTYLES)
- SM: 30 μ " SELECTIVE GOLD IN CONTACT AREA, MATTE TIN ON TAIL
- FM: 3 μ " FLASH SELECTIVE GOLD IN CONTACT AREA, MATTE TIN ON TAIL
- LM: 10 μ " LIGHT SELECTIVE GOLD IN CONTACT AREA, MATTE TIN ON TAIL

LEAD STYLE

- 01: THROUGH HOLE (USE CONTACT: C-44-01-XXX) (SEE FIG. 1, SHT. 1)
- 02: SURFACE MOUNT (USE CONTACT: C-44-02-XXX) (SEE FIG. 2, SHT. 2)
- 03: STRAIGHT MODIFIED (USE CONTACT: C-44-03-XXX) (SEE FIG. 1, SHT. 1)
- L1: THROUGH HOLE (LOW INSERTION) (USE CONTACT: C-61-01-XXX) (SEE FIG. 1, SHT. 1)
- L2: SURFACE MOUNT (LOW INSERTION) (USE CONTACT: C-61-02-XXX) (SEE FIG. 2, SHT. 2)
- L3: STRAIGHT MODIFIED (LOW INSERTION) (USE CONTACT: C-61-03-XXX) (SEE FIG. 1, SHT. 1)
- T1: THROUGH HOLE (PHOS BRONZE) (USE CONTACT: C-119-01-XXX) (SEE FIG. 1, SHT. 1)
- T2: SURFACE MOUNT (PHOS BRONZE) (USE CONTACT: C-119-02-XXX) (SEE FIG. 2, SHT. 2)

*: DIMENSIONS N/A FOR -N OPTION

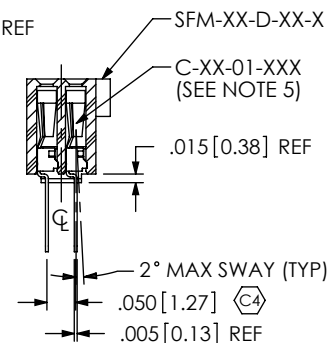
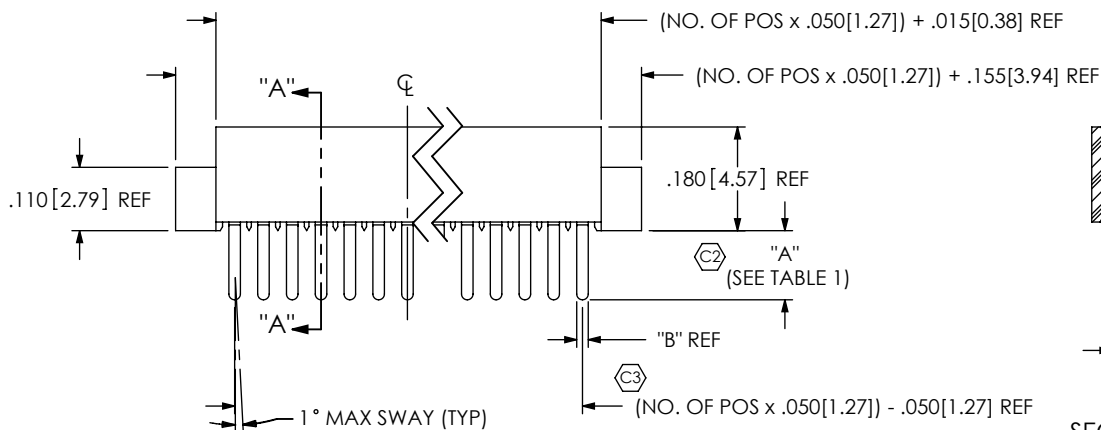
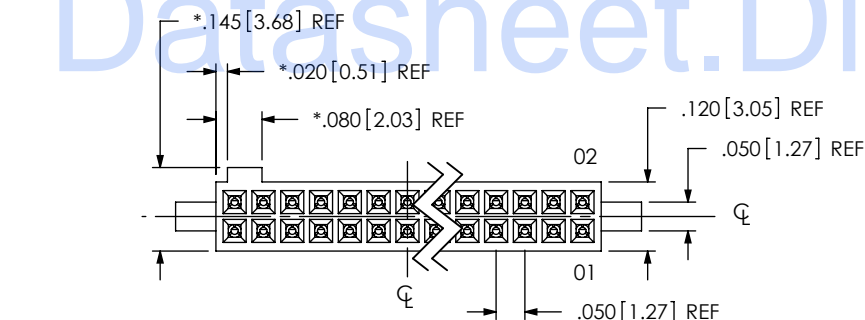

SECTION "A"-"A"

FIG 1 THROUGH HOLE/STRAIGHT MODIFIED

TABLE 1

SUFFIX	TAIL LENGTH "A"	TAIL WIDTH "B"
-X1	.120[3.05]	.020[0.51]
-X3	.075[1.91]	.016[0.41]

$\text{\textcircled{CP}}$

UNLESS OTHERWISE SPECIFIED, DIMENSIONS ARE IN INCHES. TOLERANCES ARE:
DECIMALS ANGLES
.XX: $\pm .01$ [.3]
.XXX: $\pm .005$ [.13]
.XXXX: $\pm .0020$ [.051]

PROPRIETARY NOTE
THIS DOCUMENT CONTAINS INFORMATION CONFIDENTIAL AND PROPRIETARY TO SAMTEC, INC. AND SHALL NOT BE REPRODUCED OR TRANSFERRED TO OTHER DOCUMENTS OR DISCLOSED TO OTHERS OR USED FOR ANY PURPOSE OTHER THAN THAT WHICH IT WAS OBTAINED WITHOUT THE EXPRESSED WRITTEN CONSENT OF SAMTEC, INC.

MATERIAL: DO NOT SCALE DRAWING SHEET SCALE: 3:1
INSULATOR: LCP, COLOR: BLACK
CONTACT: TIGER EYE = BeCu
TIGER EYE LITE = PHOSPHOR BRONZE

DESCRIPTION:
.050 x .050 SOCKET STRIP DOUBLE ROW ASSEMBLY

DWG. NO.
SFM-1XX-XX-XXX-D-XXX

BY: JORDAN 12/11/89 SHEET 1 OF 4

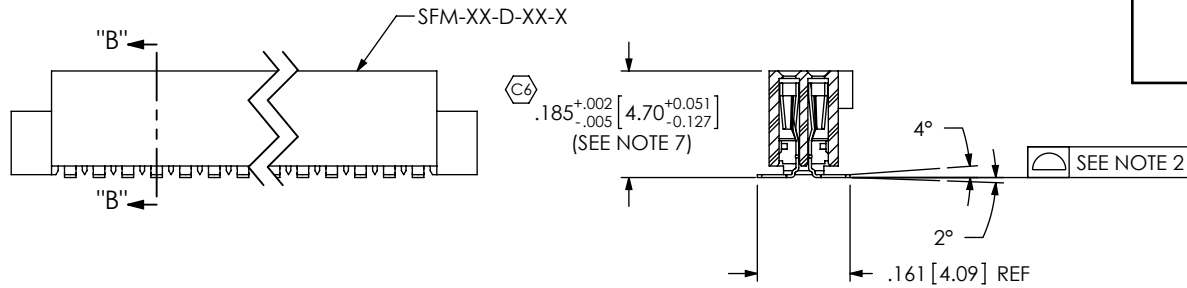
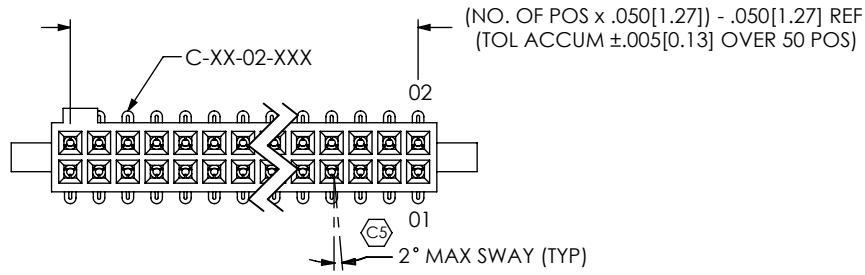

FIG 2
-X2: SURFACE MOUNT
(SAME AS FIG 1, DIFFERENT AS SHOWN)

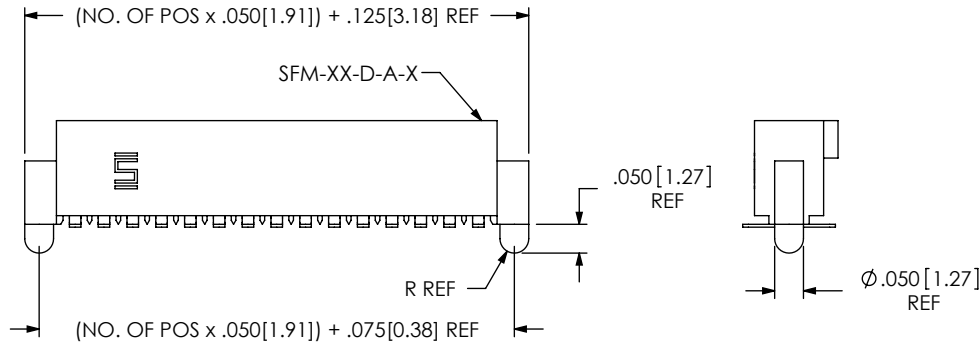

FIG 4
-A: ALIGNMENT PIN
(SAME AS FIG 1, DIFFERENT AS SHOWN)

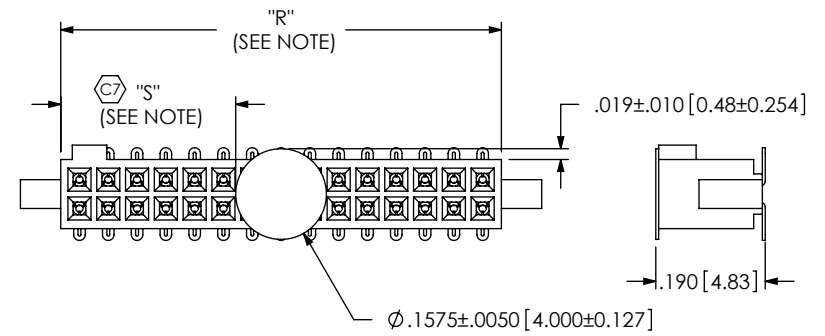

FIG 3
-K: POLYIMIDE FILM PAD
(SAME AS FIG 1, DIFFERENT AS SHOWN)
NOTE: "R" = USED MEASURED DIMENSION REF
"S" = {"R" - .1575[4.000]}/2±.020[0.51]

TABLE 2	
POS.	"A"
ODD	{{(No. OF POS x .050[1.27])/2} - .1895[4.813]}
EVEN	{{(No. OF POS x .050[1.27])/2} - .2145[5.448]}

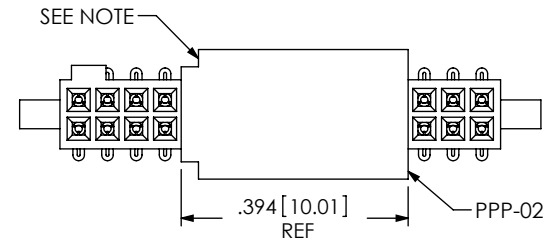

FIG 5
-P: PICK AND PLACE PAD
(PAD TO BE ORIENTED AS SHOWN FOR 5-12 POSITION PARTS)
(FOR 13-50 POSITION PARTS, PAD MAY BE ORIENTED IN EITHER DIRECTION)
(SAME AS FIG 1, DIFFERENT AS SHOWN)

PROPRIETARY NOTE
THIS DOCUMENT CONTAINS INFORMATION
CONFIDENTIAL AND PROPRIETARY TO
SAMTEC, INC. AND SHALL NOT BE REPRODUCED
OR TRANSFERRED TO OTHER DOCUMENTS OR
DISCLOSED TO OTHERS OR USED FOR ANY
PURPOSE OTHER THAN THAT WHICH IT WAS
OBTAINED WITHOUT THE EXPRESSED WRITTEN
CONSENT OF SAMTEC, INC.

DO NOT SCALE DRAWING

SHEET SCALE: 3:1

samtec

520 PARK EAST BLVD, NEW ALBANY, IN 47150
PHONE: 812-944-6733 FAX: 812-948-5047
e-Mail info@SAMTEC.com code 55322

DESCRIPTION:
.050 x .050 SOCKET STRIP DOUBLE ROW ASSEMBLY

DWG. NO.
SFM-1XX-XX-XXX-D-XXX

BY: JORDAN 12/11/89 SHEET 2 OF 4

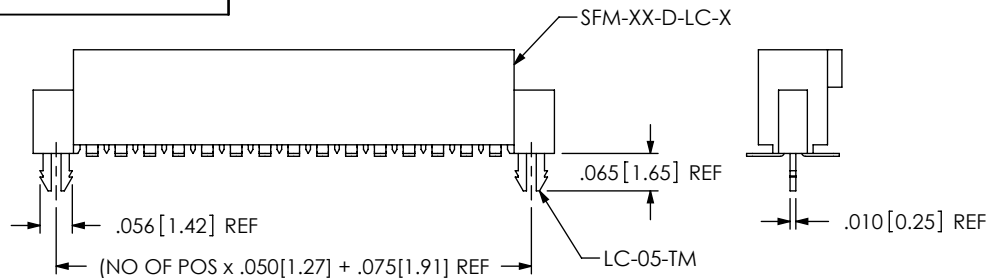

FIG 6
-LC: LOCKING CLIP
(SAME AS FIG 1, DIFFERENT AS SHOWN)
(AVAILABLE IN ALL LEADS)

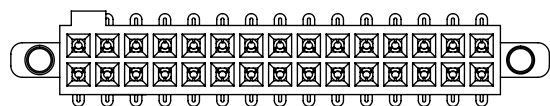
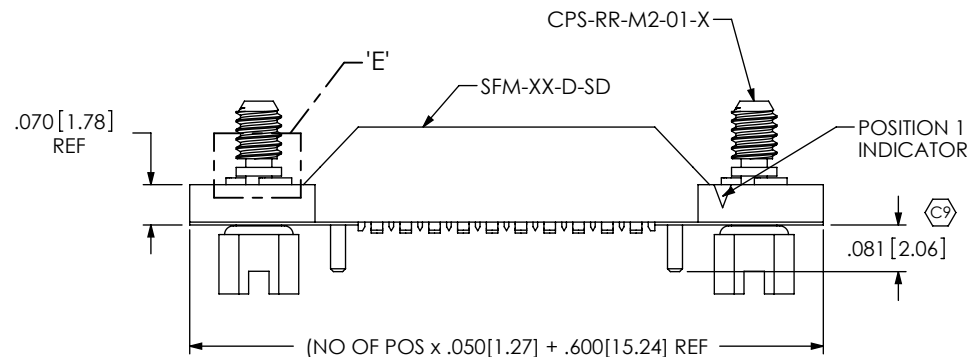
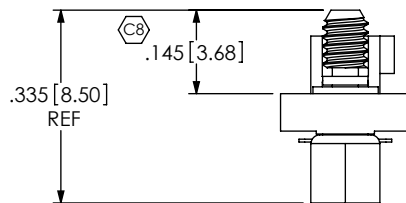
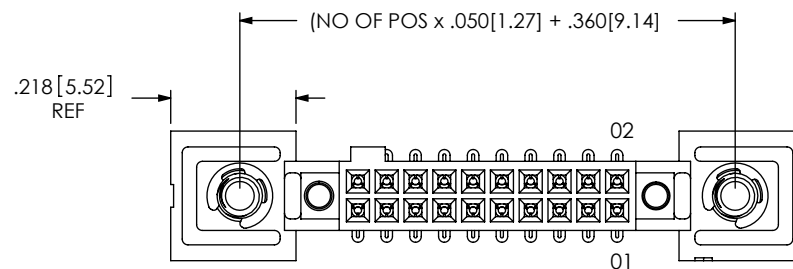

TABLE 3	
OPTION	"C"
-SN	.066 [1.68]
-SN2	.101 [1.80]

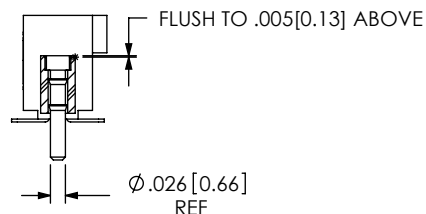
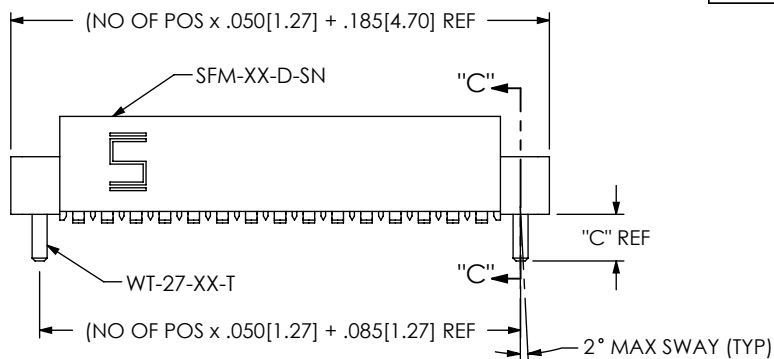

FIG 7
-SNX: SOLDER NAIL
(SAME AS FIG 1, DIFFERENT AS SHOWN)

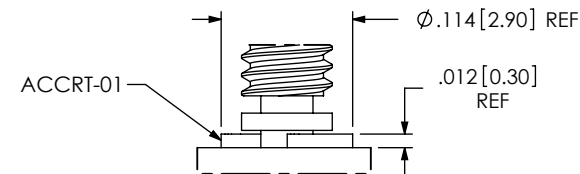

FIG 8
-SD: SCREW DOWN
(SAME AS FIG 7, DIFFERENT AS SHOWN)
(NOT RELEASED FOR PRODUCTION)

PROPRIETARY NOTE
THIS DOCUMENT CONTAINS INFORMATION
CONFIDENTIAL AND PROPRIETARY TO
SAMTEC, INC. AND SHALL NOT BE REPRODUCED
OR TRANSFERRED TO OTHER DOCUMENTS OR
DISCLOSED TO OTHERS OR USED FOR ANY
PURPOSE OTHER THAN THAT WHICH IT WAS
OBTAINED WITHOUT THE EXPRESSED WRITTEN
CONSENT OF SAMTEC, INC.

DO NOT SCALE DRAWING
SHEET SCALE: 3:1

samtec

520 PARK EAST BLVD, NEW ALBANY, IN 47150
PHONE: 812-944-6733 FAX: 812-948-5047
e-Mail info@SAMTEC.com code 55322

DESCRIPTION:
.050 x .050 SOCKET STRIP DOUBLE ROW ASSEMBLY

DWG. NO.
SFM-1XX-XX-XXX-D-XXX

BY: JORDAN 12/11/89 SHEET 3 OF 4

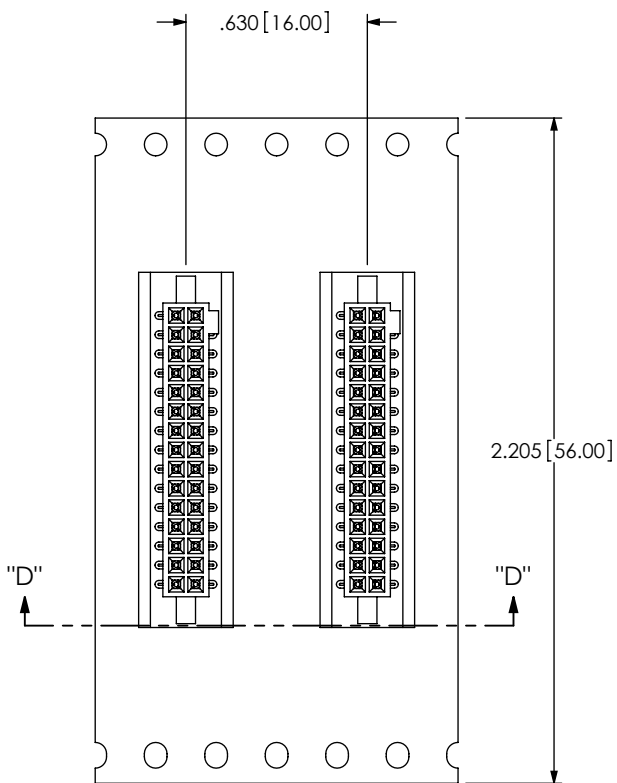

UNWINDING DIRECTION →

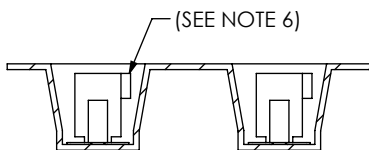

SECTION "D"- "D"
SCALE 2 : 1

PACKAGING VIEW
-TR: TAPE AND REEL

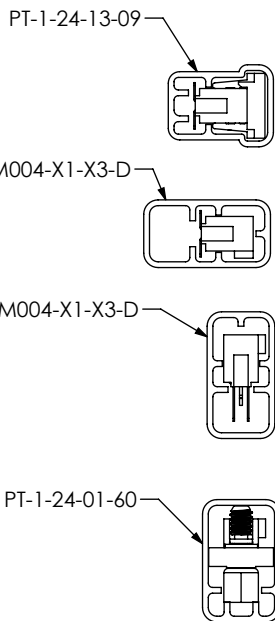

CN PACKAGING VIEW
PACKAGE PARTS IN TUBES AS SHOWN (SEE NOTE 4)

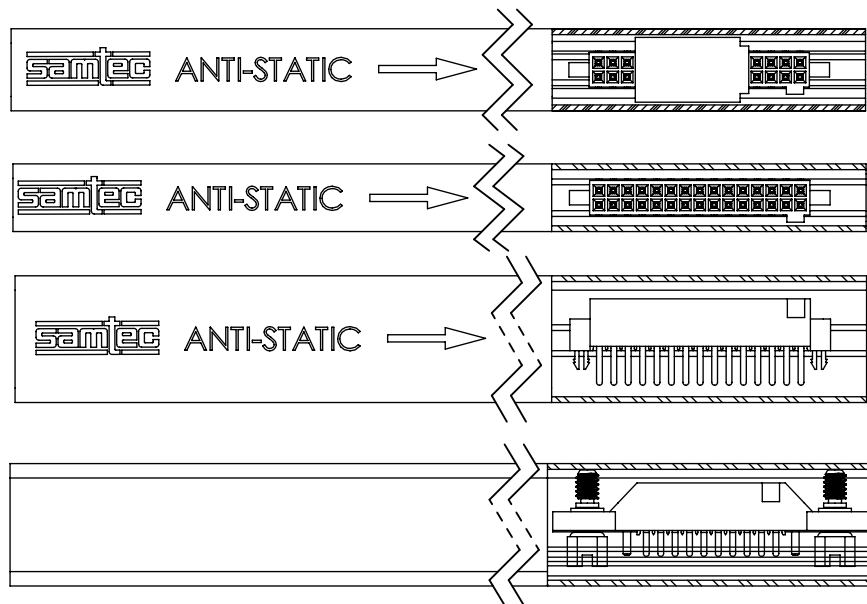

LEAD STYLE	PACKAGING TUBE	PLUG
-105-X2-X-D, -105X2-X-D-LC, -105-X2-D-A, -105-X2-D-K-LC	PT-SFM004-X1-X3-D	TP-24-02
-X1-D, -X3-D, -X1-D-LC, -X3-D-LC, (NO P&P PAD), X1-D-A, -X3-D-A, -X1-D-K	PT-SFM004-X1-X3-D	TP-24-02
-X1-D-P, -X1-D-LC-P (WITH P&P PAD), X1-D-A-P	PT-1-24-02-17	TP-09
-X2-D, -X2-D-K, -X2-D-LC (NO P&P PAD), X2-D-A, -X2-D-K-A	PT-SFM004-X1-X3-D	TP-24-02
-X2-D-P, -X3-D-P, -X2-D-LC-P (WITH P&P PAD), -X2-D-A-P, X3-D-A-P	PT-1-24-13-09	TP-24
-01-SD, -02-SD	PT-1-24-01-60	TP-03

5 POS -01 AND -03 LEAD STYLES MAY BE TUBED USING PT-1-24-15-09, TP-24-02

PROPRIETARY NOTE

THIS DOCUMENT CONTAINS INFORMATION CONFIDENTIAL AND PROPRIETARY TO SAMTEC, INC. AND SHALL NOT BE REPRODUCED OR TRANSFERRED TO OTHER DOCUMENTS OR DISCLOSED TO OTHERS OR USED FOR ANY PURPOSE OTHER THAN THAT WHICH IT WAS OBTAINED WITHOUT THE EXPRESSED WRITTEN CONSENT OF SAMTEC, INC.

DO NOT SCALE DRAWING

SHEET SCALE: 1.5:1



520 PARK EAST BLVD, NEW ALBANY, IN 47150
PHONE: 812-944-6733 FAX: 812-948-5047
e-Mail info@SAMTEC.com code 55322

DESCRIPTION:
.050 x .050 SOCKET STRIP DOUBLE ROW ASSEMBLY

DWG. NO.
SFM-1XX-XX-XXX-D-XXX

BY: JORDAN 12/11/89 SHEET 4 OF 4