

# 4N25M, 4N26M, 4N27M, 4N28M, 4N35M, 4N36M, 4N37M, H11A1M, H11A2M, H11A3M, H11A4M, H11A5M General Purpose 6-Pin Phototransistor Optocouplers

## Features

- UL recognized (File # E90700, Volume 2)
- VDE recognized (File # 102497)
  - Add option V (e.g., 4N25VM)

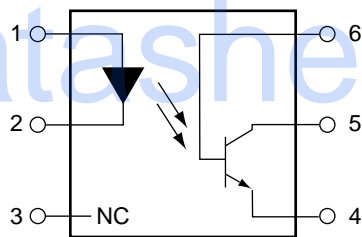
## Applications

- Power supply regulators
- Digital logic inputs
- Microprocessor inputs

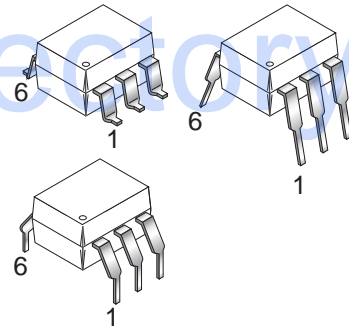
## Description

The general purpose optocouplers consist of a gallium arsenide infrared emitting diode driving a silicon phototransistor in a 6-pin dual in-line package.

## Functional Block Diagram



PIN 1. ANODE  
2. CATHODE  
3. NO CONNECTION  
4. EMITTER  
5. COLLECTOR  
6. BASE



**Absolute Maximum Ratings** ( $T_A = 25^\circ\text{C}$  unless otherwise specified)

Symbol	Parameter	Value	Units
<b>TOTAL DEVICE</b>			
$T_{STG}$	Storage Temperature	-55 to +150	$^\circ\text{C}$
$T_{OPR}$	Operating Temperature	-55 to +100	$^\circ\text{C}$
$T_{SOL}$	Wave solder temperature (see page 8 for reflow solder profile)	260 for 10 sec	$^\circ\text{C}$
$P_D$	Total Device Power Dissipation @ $T_A = 25^\circ\text{C}$ Derate above $25^\circ\text{C}$	250	mW
		2.94	
<b>EMITTER</b>			
$I_F$	DC/Average Forward Input Current	60	mA
$V_R$	Reverse Input Voltage	6	V
$I_F(\text{pk})$	Forward Current – Peak (300 $\mu\text{s}$ , 2% Duty Cycle)	3	A
$P_D$	LED Power Dissipation @ $T_A = 25^\circ\text{C}$ Derate above $25^\circ\text{C}$	120	mW
		1.41	mW/ $^\circ\text{C}$
<b>DETECTOR</b>			
$V_{CEO}$	Collector-Emitter Voltage	30	V
$V_{CBO}$	Collector-Base Voltage	70	V
$V_{ECO}$	Emitter-Collector Voltage	7	V
$P_D$	Detector Power Dissipation @ $T_A = 25^\circ\text{C}$ Derate above $25^\circ\text{C}$	150	mW
		1.76	mW/ $^\circ\text{C}$

**Electrical Characteristics** ( $T_A = 25^\circ\text{C}$  unless otherwise specified)**Individual Component Characteristics**

Symbol	Parameter	Test Conditions	Min.	Typ.*	Max.	Unit
<b>EMITTER</b>						
$V_F$	Input Forward Voltage	$I_F = 10\text{mA}$		1.18	1.50	V
$I_R$	Reverse Leakage Current	$V_R = 6.0\text{V}$		0.001	10	$\mu\text{A}$
<b>DETECTOR</b>						
$BV_{CEO}$	Collector-Emitter Breakdown Voltage	$I_C = 1.0\text{mA}$ , $I_F = 0$	30	100		V
$BV_{CBO}$	Collector-Base Breakdown Voltage	$I_C = 100\mu\text{A}$ , $I_F = 0$	70	120		V
$BV_{ECO}$	Emitter-Collector Breakdown Voltage	$I_E = 100\mu\text{A}$ , $I_F = 0$	7	10		V
$I_{CEO}$	Collector-Emitter Dark Current	$V_{CE} = 10\text{V}$ , $I_F = 0$		1	50	nA
$I_{CBO}$	Collector-Base Dark Current	$V_{CB} = 10\text{V}$			20	nA
$C_{CE}$	Capacitance	$V_{CE} = 0\text{V}$ , $f = 1\text{MHz}$		8		pF

**Isolation Characteristics**

Symbol	Characteristic	Test Conditions	Min.	Typ.*	Max.	Units
$V_{ISO}$	Input-Output Isolation Voltage	$f = 60\text{Hz}$ , $t = 1\text{sec}$	7500			Vac(pk)
$R_{ISO}$	Isolation Resistance	$V_{I-O} = 500\text{VDC}$	$10^{11}$			$\Omega$
$C_{ISO}$	Isolation Capacitance	$V_{I-O} = \&$ , $f = 1\text{MHz}$		0.2	2	pF

\*Typical values at  $T_A = 25^\circ\text{C}$

**Electrical Characteristics** (Continued) ( $T_A = 25^\circ\text{C}$  unless otherwise specified)

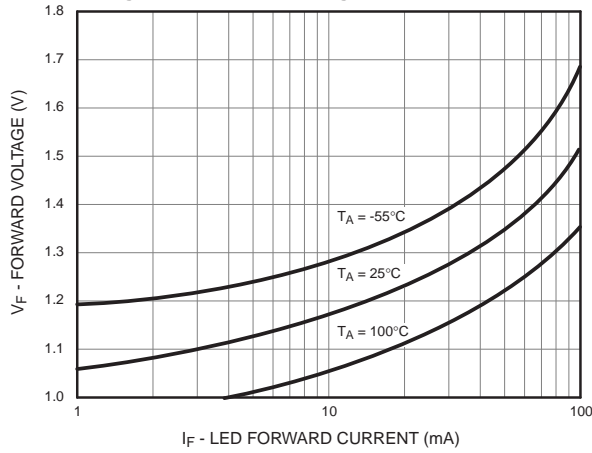
**Transfer Characteristics**

Symbol	Parameter	Test Conditions	Device	Min.	Typ.*	Max.	Unit
<b>DC CHARACTERISTICS</b>							
CTR	Current Transfer Ratio, Collector to Emitter	$I_F = 10\text{mA}$ , $V_{CE} = 10\text{V}$	4N35M, 4N36M, 4N37M	100			%
			H11A1M	50			
			H11A5M	30			
			4N25M, 4N26M H11A2M, H11A3M	20			
			4N27M, 4N28M H11A4M	10			
		$I_F = 10\text{mA}$ , $V_{CE} = 10\text{V}$ , $T_A = -55^\circ\text{C}$	4N35M, 4N36M, 4N37M	40			
		$I_F = 10\text{mA}$ , $V_{CE} = 10\text{V}$ , $T_A = +100^\circ\text{C}$	4N35M, 4N36M, 4N37M	40			
$V_{CE(SAT)}$	Collector-Emitter Saturation Voltage	$I_C = 2\text{mA}$ , $I_F = 50\text{mA}$	4N25M, 4N26M, 4N27M, 4N28M,			0.5	V
		$I_C = 0.5\text{mA}$ , $I_F = 10\text{mA}$	4N35M, 4N36M, 4N37M			0.3	
			H11A1M, H11A2M, H11A3M, H11A4M, H11A5M			0.4	
<b>AC CHARACTERISTICS</b>							
$T_{ON}$	Non-Saturated Turn-on Time	$I_F = 10\text{mA}$ , $V_{CC} = 10\text{V}$ , $R_L = 100\Omega$ (Fig. 11)	4N25M, 4N26M, 4N27M, 4N28M, H11A1M, H11A2M, H11A3M, H11A4, H11A5M		2		$\mu\text{s}$
		$I_C = 2\text{mA}$ , $V_{CC} = 10\text{V}$ , $R_L = 100\Omega$ (Fig. 11)	4N35M, 4N36M, 4N37M		2	10	$\mu\text{s}$
$T_{OFF}$	Turn-off Time	$I_F = 10\text{mA}$ , $V_{CC} = 10\text{V}$ , $R_L = 100\Omega$ (Fig. 11)	4N25M, 4N26M, 4N27M, 4N28M, H11A1M, H11A2M, H11A3M, H11A4M, H11A5M		2		$\mu\text{s}$
		$I_C = 2\text{mA}$ , $V_{CC} = 10\text{V}$ , $R_L = 100\Omega$ (Fig. 11)	4N35M, 4N36M, 4N37M		2	10	

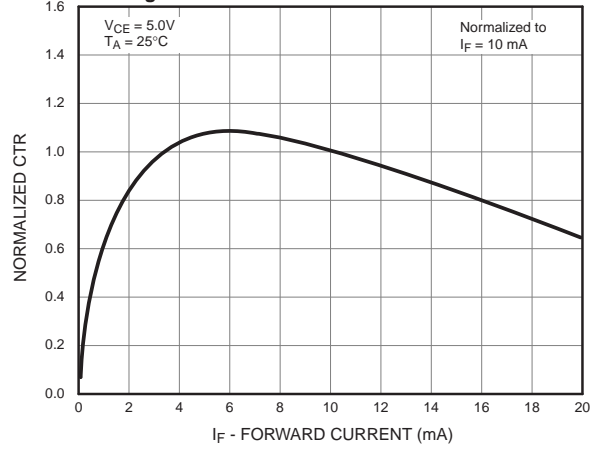
\* Typical values at  $T_A = 25^\circ\text{C}$

## Typical Performance Curves

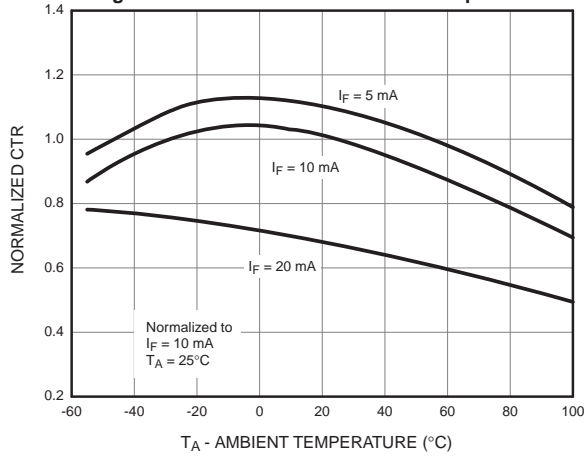
**Fig. 1 LED Forward Voltage vs. Forward Current**



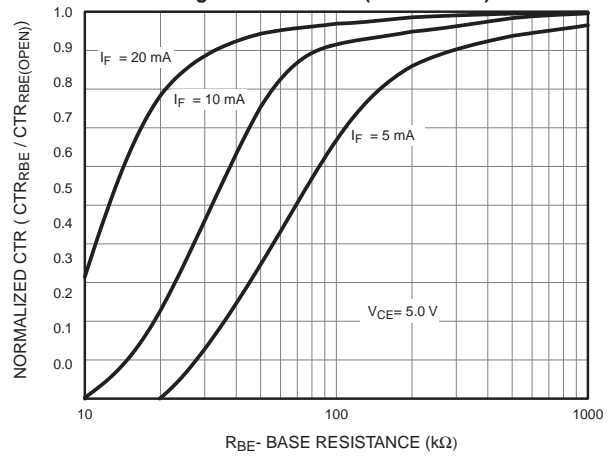
**Fig.2 Normalized CTR vs. Forward Current**



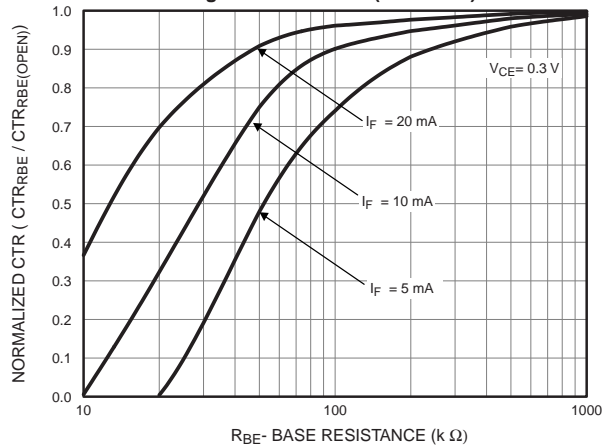
**Fig. 3 Normalized CTR vs. Ambient Temperature**



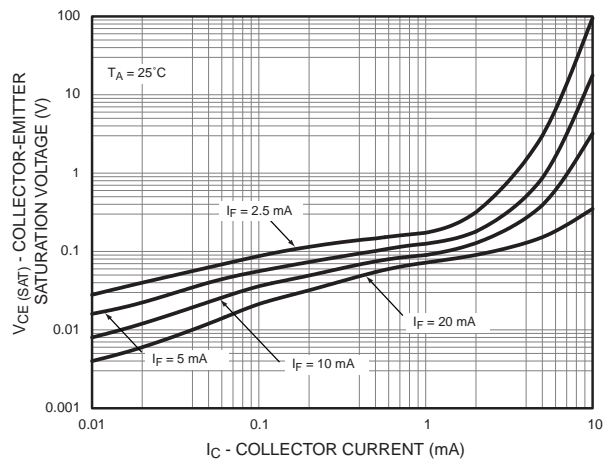
**Fig. 4 CTR vs. RBE (Unsaturated)**

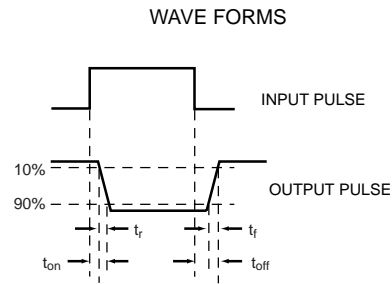
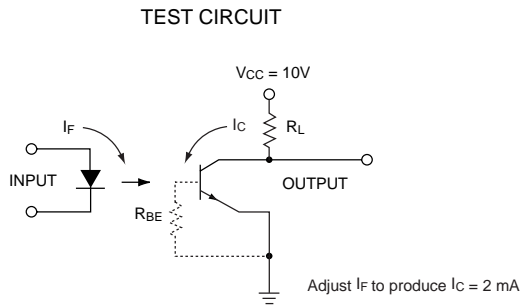
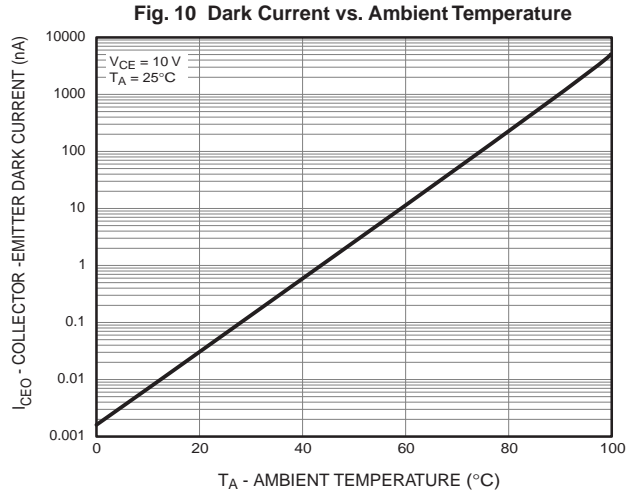
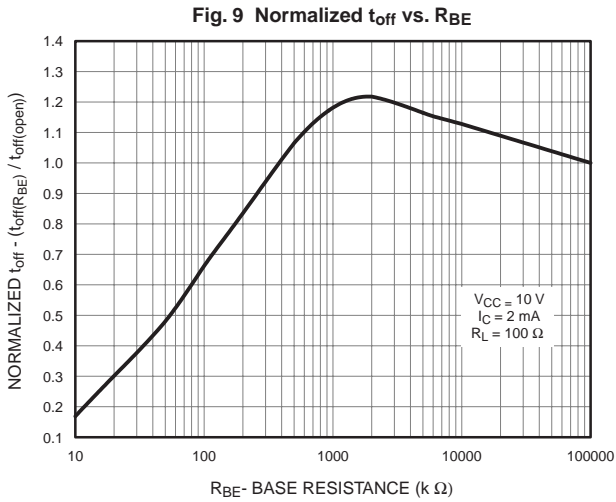
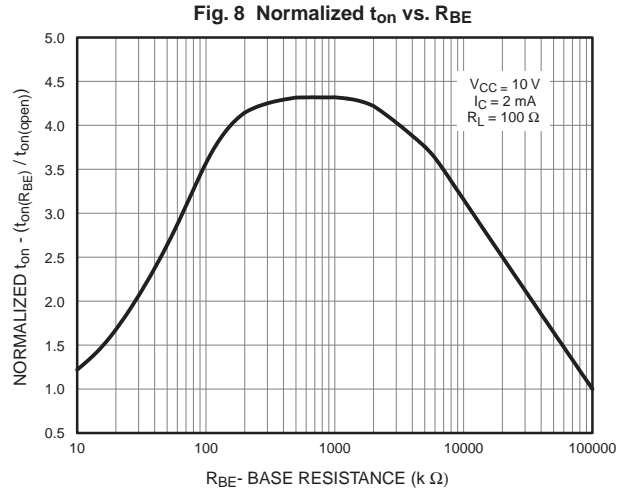
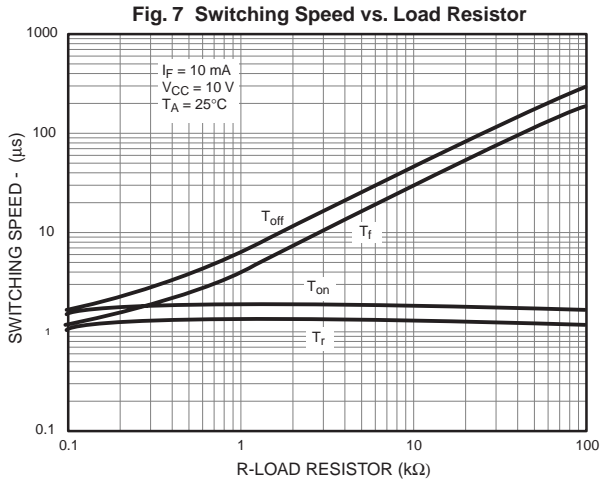


**Fig. 5 CTR vs. RBE (Saturated)**



**Fig. 6 Collector-Emitter Saturation Voltage vs. Collector Current**

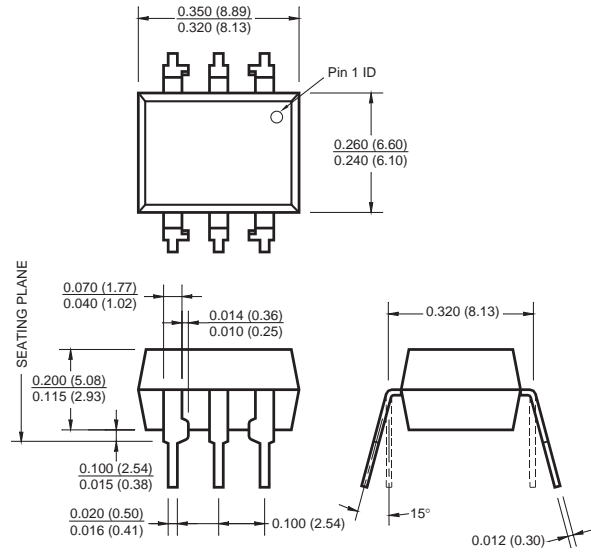




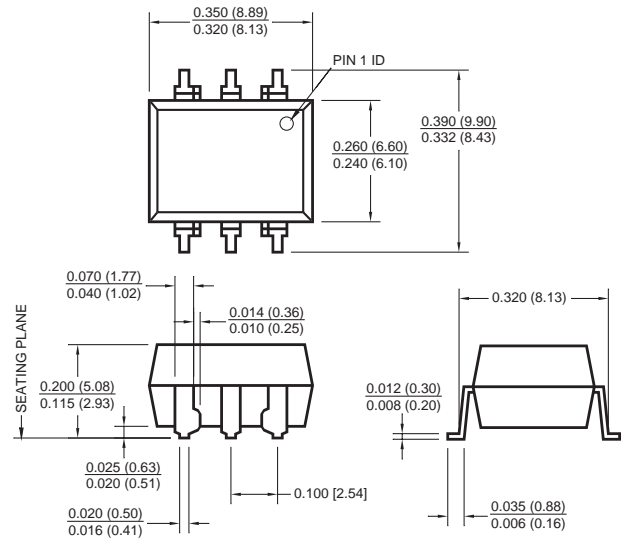
**Figure 11. Switching Time Test Circuit and Waveforms**

## Package Dimensions

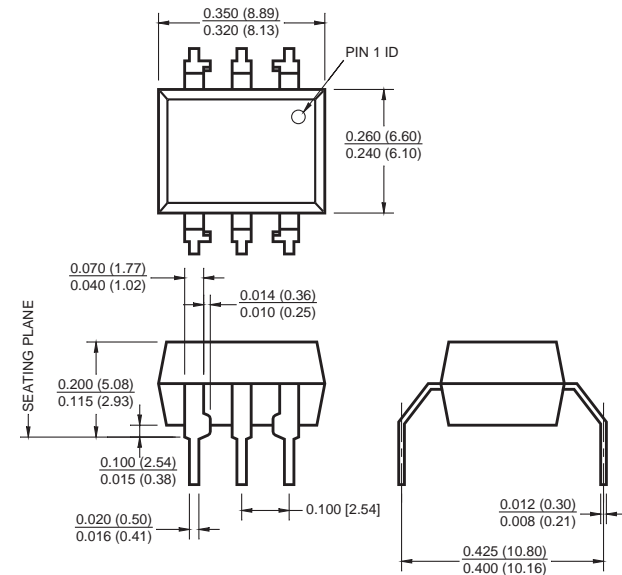
### Through Hole



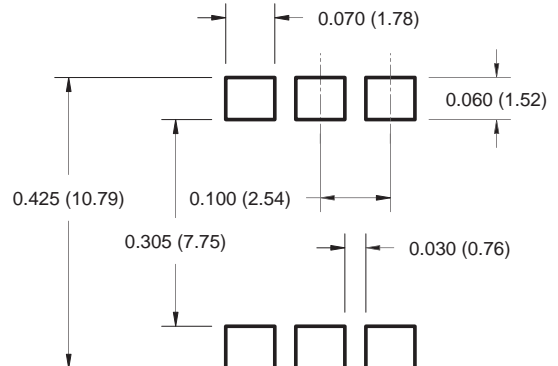
### Surface Mount



### 0.4" Lead Spacing



### Recommended Pad Layout for Surface Mount Leadform



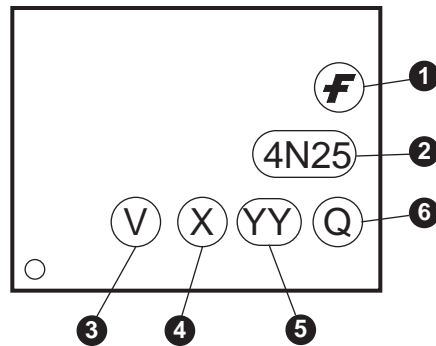
### Note:

All dimensions are in inches (millimeters)

## Ordering Information

Option	Order Entry Identifier (Example)	Description
No option	4N25M	Standard Through Hole Device
S	4N25SM	Surface Mount Lead Bend
SR2	4N25SR2M	Surface Mount; Tape and Reel
T	4N25TM	0.4" Lead Spacing
V	4N25VM	VDE 0884
TV	4N25TVM	VDE 0884, 0.4" Lead Spacing
SV	4N25SVM	VDE 0884, Surface Mount
SR2V	4N25SR2VM	VDE 0884, Surface Mount, Tape and Reel

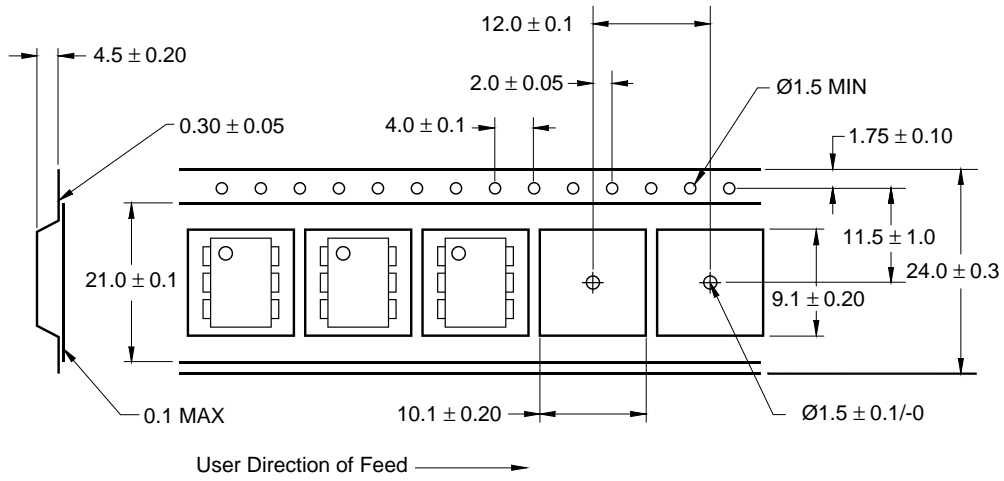
## Marking Information



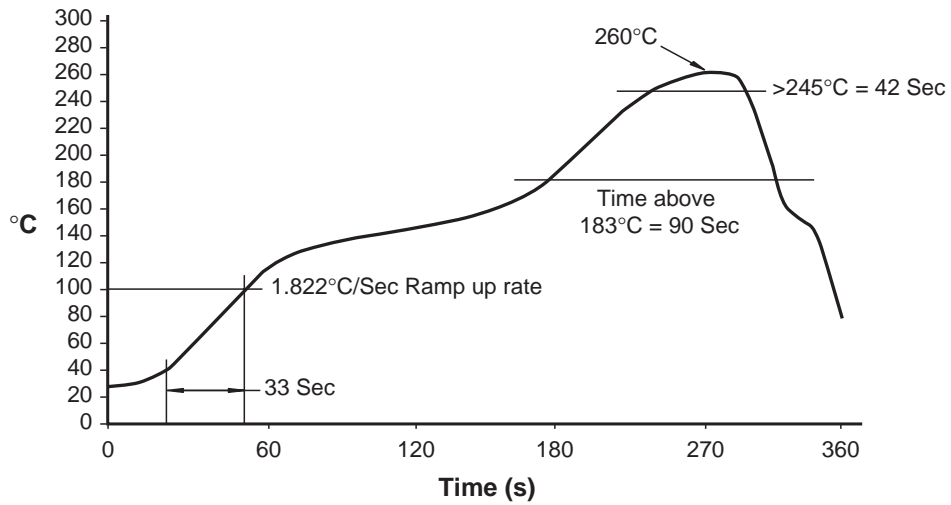
Definitions	
1	Fairchild logo
2	Device number
3	VDE mark (Note: Only appears on parts ordered with VDE option – See order entry table)
4	One digit year code, e.g., '7'
5	Two digit work week ranging from '01' to '53'
6	Assembly package code

\*Note – Parts that do not have the 'V' option (see definition 3 above) that are marked with date code '325' or earlier are marked in portrait format.

### Carrier Tape Specification



### Reflow Profile








## TRADEMARKS

The following are registered and unregistered trademarks Fairchild Semiconductor owns or is authorized to use and is not intended to be an exhaustive list of all such trademarks.

ACEx <sup>®</sup>	HiSeC <sup>™</sup>	Programmable Active Droop <sup>™</sup>	TinyLogic <sup>®</sup>
Across the board. Around the world. <sup>™</sup>	<i>i-Lo</i> <sup>™</sup>	QFET <sup>®</sup>	TINYOPTO <sup>™</sup>
ActiveArray <sup>™</sup>	ImpliedDisconnect <sup>™</sup>	QS <sup>™</sup>	TinyPower <sup>™</sup>
Bottomless <sup>™</sup>	IntelliMAX <sup>™</sup>	QT Optoelectronics <sup>™</sup>	TinyWire <sup>™</sup>
Build it Now <sup>™</sup>	ISOPLANAR <sup>™</sup>	Quiet Series <sup>™</sup>	TruTranslation <sup>™</sup>
CoolFET <sup>™</sup>	MICROCOUPLER <sup>™</sup>	RapidConfigure <sup>™</sup>	μSerDes <sup>™</sup>
CROSSVOLT <sup>™</sup>	MicroPak <sup>™</sup>	RapidConnect <sup>™</sup>	UHC <sup>®</sup>
CTL <sup>™</sup>	MICROWIRE <sup>™</sup>	ScalarPump <sup>™</sup>	UniFET <sup>™</sup>
Current Transfer Logic <sup>™</sup>	MSX <sup>™</sup>	SMART START <sup>™</sup>	VCX <sup>™</sup>
DOME <sup>™</sup>	MSXPro <sup>™</sup>	SPM <sup>®</sup>	Wire <sup>™</sup>
E <sup>2</sup> CMOS <sup>™</sup>	OCX <sup>™</sup>	STEALTH <sup>™</sup>	
EcoSPARK <sup>®</sup>	OCXPro <sup>™</sup>	SuperFET <sup>™</sup>	
EnSigna <sup>™</sup>	OPTOLOGIC <sup>®</sup>	SuperSOT <sup>™</sup> -3	
FACT Quiet Series <sup>™</sup>	OPTOPLANAR <sup>®</sup>	SuperSOT <sup>™</sup> -6	
FACT <sup>®</sup>	PACMAN <sup>™</sup>	SuperSOT <sup>™</sup> -8	
FAST <sup>®</sup>	POP <sup>™</sup>	SyncFET <sup>™</sup>	
FASTr <sup>™</sup>	Power220 <sup>®</sup>	TCM <sup>™</sup>	
FPS <sup>™</sup>	Power247 <sup>®</sup>	The Power Franchise <sup>®</sup>	
FRFET <sup>®</sup>	PowerEdge <sup>™</sup>	 ™	
GlobalOptoisolator <sup>™</sup>	PowerSaver <sup>™</sup>	TinyBoost <sup>™</sup>	
GTO <sup>™</sup>	PowerTrench <sup>®</sup>	TinyBuck <sup>™</sup>	

## DISCLAIMER

FAIRCHILD SEMICONDUCTOR RESERVES THE RIGHT TO MAKE CHANGES WITHOUT FURTHER NOTICE TO ANY PRODUCTS HEREIN TO IMPROVE RELIABILITY, FUNCTION OR DESIGN. FAIRCHILD DOES NOT ASSUME ANY LIABILITY ARISING OUT OF THE APPLICATION OR USE OF ANY PRODUCT OR CIRCUIT DESCRIBED HEREIN; NEITHER DOES IT CONVEY ANY LICENSE UNDER ITS PATENT RIGHTS, NOR THE RIGHTS OF OTHERS. THESE SPECIFICATIONS DO NOT EXPAND THE TERMS OF FAIRCHILD'S WORLDWIDE TERMS AND CONDITIONS, SPECIFICALLY THE WARRANTY THEREIN, WHICH COVERS THESE PRODUCTS.

## LIFE SUPPORT POLICY

FAIRCHILD'S PRODUCTS ARE NOT AUTHORIZED FOR USE AS CRITICAL COMPONENTS IN LIFE SUPPORT DEVICES OR SYSTEMS WITHOUT THE EXPRESS WRITTEN APPROVAL OF FAIRCHILD SEMICONDUCTOR CORPORATION.

As used herein:

1. Life support devices or systems are devices or systems which, (a) are intended for surgical implant into the body or (b) support or sustain life, and (c) whose failure to perform when properly used in accordance with instructions for use provided in the labeling, can be reasonably expected to result in a significant injury of the user.
2. A critical component in any component of a life support, device, or system whose failure to perform can be reasonably expected to cause the failure of the life support device or system, or to affect its safety or effectiveness.

## PRODUCT STATUS DEFINITIONS

### Definition of Terms

Datasheet Identification	Product Status	Definition
Advance Information	Formative or In Design	This datasheet contains the design specifications for product development. Specifications may change in any manner without notice.
Preliminary	First Production	This datasheet contains preliminary data; supplementary data will be published at a later date. Fairchild Semiconductor reserves the right to make changes at any time without notice to improve design.
No Identification Needed	Full Production	This datasheet contains final specifications. Fairchild Semiconductor reserves the right to make changes at any time without notice to improve design.
Obsolete	Not In Production	This datasheet contains specifications on a product that has been discontinued by Fairchild Semiconductor. The datasheet is printed for reference information only.

Rev. I24

Home >> Find products >>

## H11A3-M

6-Pin DIP Package Phototransistor Output Optocoupler

### Contents

- [General description](#)
- [Features](#)
- [Applications](#)
- [Product status/pricing/packaging](#)
- [Order Samples](#)
- [Qualification Support](#)

### General description

The general purpose optocouplers consist of a gallium arsenide infrared emitting diode driving a silicon phototransistor in a 6-pin dual-in-line package.

[back to top](#)

### Features

- UL recognized (File #E90700, Volume 2)
- VDE recognized (File #102497)
  - Add option V (e.g. 4N25VM)

[back to top](#)

### Applications

- Power supply regulators
- Digital logic inputs
- Microprocessor inputs

[back to top](#)

[Product status/pricing/packaging](#)

**BUY**

**BUY**

### Datasheet

[Download this datasheet](#)



[e-mail this datasheet](#)



### This page

[Print version](#)

### Related Links

[Request samples](#)

[How to order products](#)













[Product Change Notices \(PCNs\)](#)

[Support](#)

[Sales support](#)

[Quality and reliability](#)

[Design center](#)

Product	Product status	Pb-free Status	Pricing*	Package type	Leads	Packing method
H11A3FM	Lifetime Buy		N/A	DIP-W	6	BULK
H11A3FR2M	Lifetime Buy		N/A	SMDIP-W	6	TAPE REEL
H11A3FR2VM	Lifetime Buy		N/A	SMDIP-W	6	TAPE REEL
H11A3FVM	Lifetime Buy		N/A	DIP-W	6	BULK
H11A3M	Full Production	 Full Production	\$0.229	DIP-W	6	BULK
H11A3SM	Full Production	 Full Production	\$0.165	SMDIP-W	6	BULK
H11A3SR2M	Full Production	 Full Production	\$0.206	SMDIP-W	6	TAPE REEL
H11A3SR2VM	Full Production	 Full Production	\$0.206	SMDIP-W	6	TAPE REEL
H11A3SVM	Full Production	 Full Production	\$0.165	SMDIP-W	6	BULK
H11A3TM	Full Production	 Full Production	\$0.165	DIP-W	6	BULK
H11A3TVM	Full Production	 Full Production	\$0.165	DIP-W	6	BULK
H11A3VM	Full Production	 Full Production	\$0.165	DIP-W	6	BULK

\* Fairchild 1,000 piece Budgetary Pricing

\*\* A sample button will appear if the part is available through Fairchild's on-line samples program. If there is no sample button, please contact a [Fairchild distributor](#) to obtain samples



Indicates product with Pb-free second-level interconnect. For more information [click here](#).

[back to top](#)

### Qualification Support

Click on a product for detailed qualification data

Product
<a href="#">H11A3FM</a>
<a href="#">H11A3FR2M</a>
<a href="#">H11A3FR2VM</a>
<a href="#">H11A3FVM</a>
<a href="#">H11A3M</a>
<a href="#">H11A3SM</a>
<a href="#">H11A3SR2M</a>
<a href="#">H11A3SR2VM</a>
<a href="#">H11A3SVM</a>
<a href="#">H11A3TM</a>
<a href="#">H11A3TVM</a>
<a href="#">H11A3VM</a>

[back to top](#)

© 2007 Fairchild Semiconductor

