

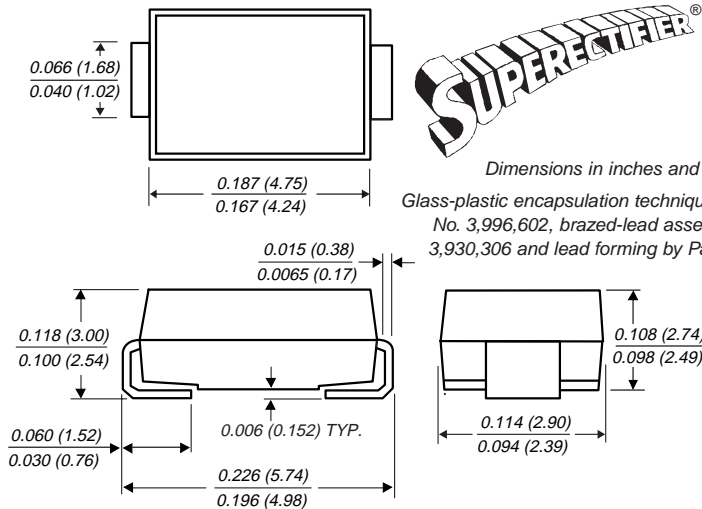

**Surface Mount Glass Passivated Junction  
Fast Switching Rectifier**

**Reverse Voltage** 50 to 1000V  
**Forward Current** 1.0A

**DO-214BA (GF1)**



**Mounting Pad Layout**

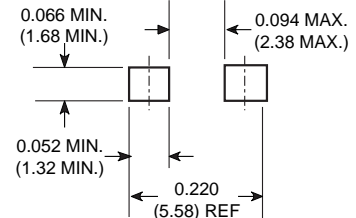

**Features**

- Plastic package has Underwriters Laboratories Flammability Classification 94V-0
- Ideal for surface mount automotive applications
- High temperature metallurgically bonded construction
- Cavity-free glass passivated junction
- Capable of meeting environmental standards of MIL-S-19500
- Built-in strain relief • Easy pick and place
- Fast switching for high efficiency
- High temperature soldering guaranteed: 450°C/5 seconds at terminals.
- Complete device submersible temperature of 265°C for 10 seconds in solder bath

**Mechanical Data**

**Case:** JEDEC DO-214BA, molded plastic over glass body  
**Terminals:** Solder plated, solderable per MIL-STD-750, Method 2026  
**Polarity:** Color band denotes cathode end  
**Mounting Position:** Any **Weight:** 0.0048 oz, 0.12 g  
**Packaging codes/options:**  
 19/6.5K per 13" Reel (12mm Tape)  
 17/1.5K per 7" Reel (12mm Tape)

**Maximum Ratings & Thermal Characteristics** Ratings at 25°C ambient temperature unless otherwise specified.

Parameter	Symbol	RGF1A	RGF1B	RGF1D	RGF1G	RGF1J	RGF1K	RGF1M	Unit
Device marking code		RA	RB	RD	RG	RJ	RK	RM	
Maximum repetitive peak reverse voltage	V <sub>RRM</sub>	50	100	200	400	600	800	1000	V
Maximum RMS voltage	V <sub>RMS</sub>	35	70	140	280	420	560	700	V
Maximum DC blocking voltage	V <sub>DC</sub>	50	100	200	400	600	800	1000	V
Maximum average forward rectified current at T <sub>L</sub> = 120°C	I <sub>F(AV)</sub>	1.0							A
Peak forward surge current 8.3ms single half sine-wave superimposed on rated load (JEDEC Method)	I <sub>FSM</sub>	30							A
Max. full load reverse current, full cycle average T <sub>A</sub> = 55°C	I <sub>R(AV)</sub>	50							μA
Typical thermal resistance <sup>(1)</sup>	R <sub>θJA</sub> R <sub>θJL</sub>	80 28							°C/W
Operating junction and storage temperature range	T <sub>J</sub> , T <sub>STG</sub>	-65 to +175							°C

**Electrical Characteristics** (T<sub>J</sub> = 25°C unless otherwise noted)

Parameter	Symbol	RGF1A	RGF1B	RGF1D	RGF1G	RGF1J	RGF1K	RGF1M	Unit
Maximum instantaneous forward voltage at 1.0A	V <sub>F</sub>	1.30							V
Maximum DC reverse current T <sub>A</sub> = 25°C at rated DC blocking voltage T <sub>A</sub> = 125°C	I <sub>R</sub>	5.0 100							μA
Typical reverse recovery time at I <sub>F</sub> = 0.5A, I <sub>R</sub> = 1.0A, I <sub>rr</sub> = 0.25 A	t <sub>rr</sub>	150			250		500		ns
Typical junction capacitance at 4.0V, 1MHz	C <sub>J</sub>	8.5							pF

**Note:** (1) Thermal resistance from junction to ambient and from junction to lead, P.C.B. mounted on 0.2 x 0.2" (5.0 x 5.0mm) copper pad areas

# RGF1A thru RGF1M

Vishay Semiconductors  
formerly General Semiconductor



## Ratings and Characteristic Curves (T<sub>A</sub> = 25°C unless otherwise noted)

**Fig. 1 – Forward Current Derating Curve**

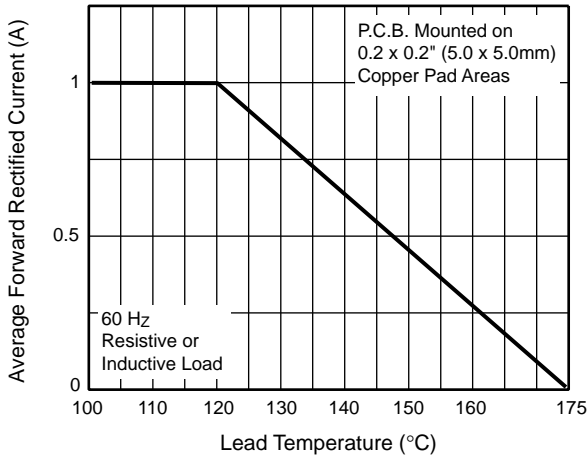

**Fig. 2 – Maximum Non-Repetitive Peak Forward Surge Current**

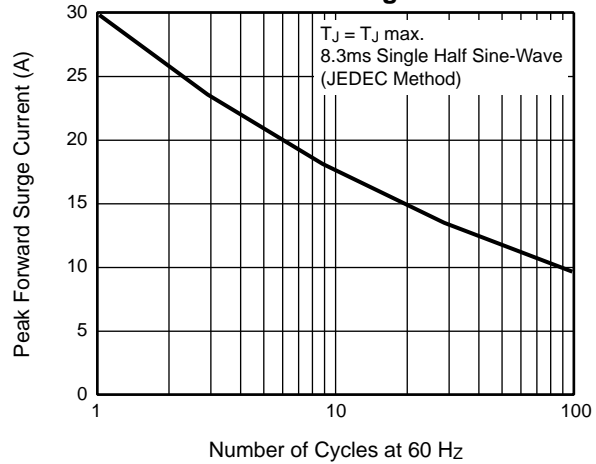

**Fig. 3 – Typical Instantaneous Forward Characteristics**

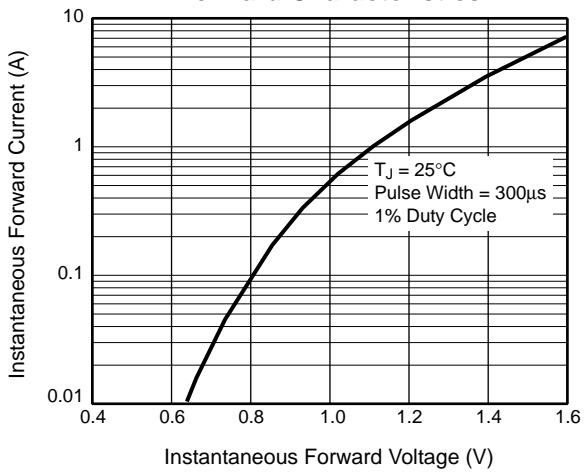

**Fig. 4 – Typical Reverse Characteristics**

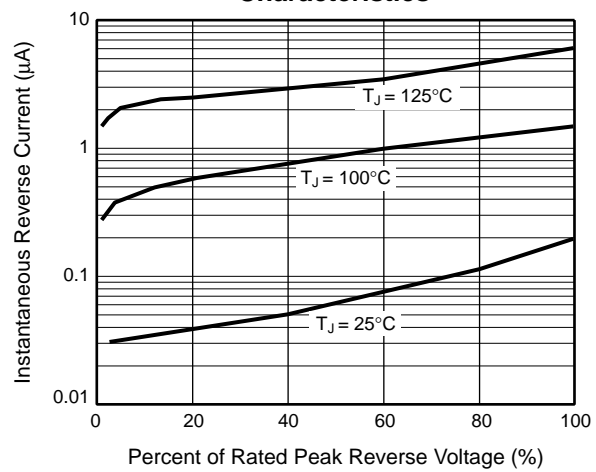

**Fig. 5 – Typical Junction Capacitance**

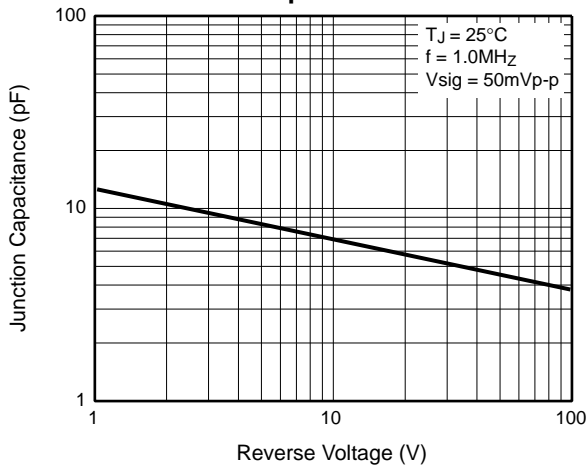

**Fig. 6 – Typical Transient Thermal Impedance**

