

MMSZ5226B - MMSZ5257B Series Zeners

Absolute Maximum Ratings*

TA = 25°C unless otherwise noted

Symbol	Parameter	Value	Units
P _D	Total Device Dissipation @ 25°C	500	mW
	Derate above 25°C	6.7	mW/°C
R _{θJA}	Thermal Resistance, Junction to Ambient **	340	°C/W
T _{stg}	Storage Temperature Range	-55 to +150	°C
T _J	Operating Junction Temperature	-55 to +150	°C

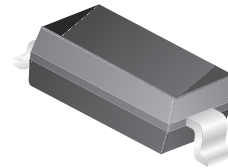

SOD123
Mark: B2

*These ratings are limiting values above which serviceability of any semiconductor may be impaired.
**FR-4 or FR-5 = 3.5 x 1.5 inches using minimum recommended land pads.

Electrical Characteristics T_A = 25°C unless otherwise noted

Device	Mark	VZ (V)	ZZ (Ω)	IZT (mA)	ZZK (Ω)	IZK (mA)	VR (V)	IR (μA)
MMSZ5226B	D1	3.3	28	20	1600	0.25	1.0	25
MMSZ5227B	D2	3.6	24	20	1700	0.25	1.0	15
MMSZ5228B	D3	3.9	23	20	1900	0.25	1.0	10
MMSZ5229B	D4	4.3	22	20	1000	0.25	1.0	5.0
MMSZ5230B	D5	4.7	19	20	1900	0.25	2.0	5.0
MMSZ5231B	E1	5.1	17	20	1600	0.25	2.0	5.0
MMSZ5232B	E2	5.6	11	20	1600	0.25	3.0	5.0
MMSZ5233B	E3	6.0	7	20	1600	0.25	3.5	5.0
MMSZ5234B	E4	6.2	7	20	1000	0.25	4.0	5.0
MMSZ5235B	E5	6.8	5	20	750	0.25	5.0	3.0
MMSZ5236B	F1	7.5	6	20	500	0.25	6.0	3.0
MMSZ5237B	F2	8.2	8	20	500	0.25	6.5	3.0
MMSZ5238B	F3	8.7	8	20	600	0.25	6.5	3.0
MMSZ5239B	F4	9.1	10	20	600	0.25	7.0	3.0
MMSZ5240B	F5	10	17	20	600	0.25	8.0	3.0
MMSZ5241B	H1	11	22	20	600	0.25	8.4	2.0
MMSZ5242B	H2	12	30	20	600	0.25	9.1	1.0
MMSZ5243B	H3	13	13	9.5	600	0.25	9.9	0.5
MMSZ5244B	H4	14	15	9.0	600	0.25	10	0.1
MMSZ5245B	H5	15	16	8.5	600	0.25	11	0.1
MMSZ5246B	J1	16	17	7.8	600	0.25	12	0.1
MMSZ5247B	J2	17	19	7.4	600	0.25	13	0.1
MMSZ5248B	J3	18	21	7.0	600	0.25	14	0.1
MMSZ5249B	J4	19	23	6.6	600	0.25	14	0.1
MMSZ5250B	J5	20	25	6.2	600	0.25	15	0.1
MMSZ5251B	K1	22	29	5.6	600	0.25	17	0.1
MMSZ5252B	K2	24	33	5.2	600	0.25	18	0.1
MMSZ5253B	K3	25	35	5.0	600	0.25	19	0.1
MMSZ5254B	K4	27	41	4.6	600	0.25	21	0.1
MMSZ5255B	K5	28	44	4.5	600	0.25	21	0.1
MMSZ5256B	M1	30	49	4.2	600	0.25	23	0.1
MMSZ5257B	M2	33	58	3.8	700	0.25	25	0.1

VF Forward Voltage = 0.9V maximum @ IF = 10mA for all MMSZ5200 series

Typical Characteristics

Zener Current vs. Zener Voltage

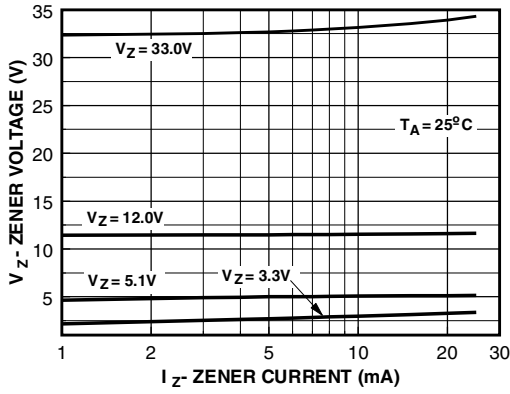

Zener Current vs. Zener Impedance

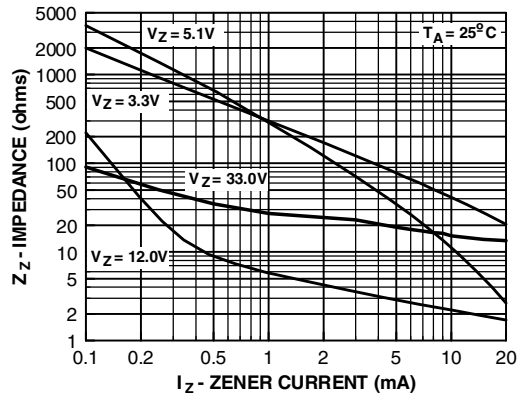

3.3 Zener Voltage vs. Temperature

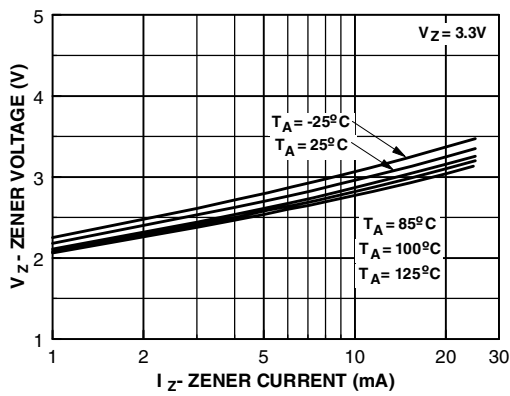

5.1 Zener Voltage vs. Temperature

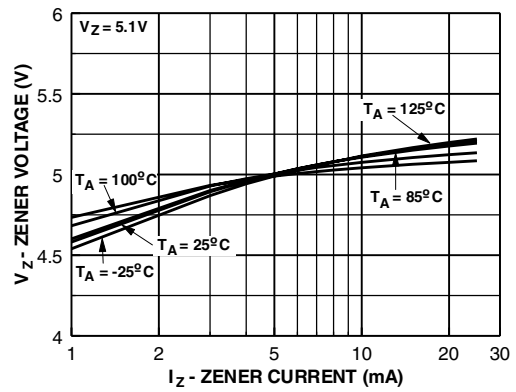

12 Zener Voltage vs. Zener Temperature

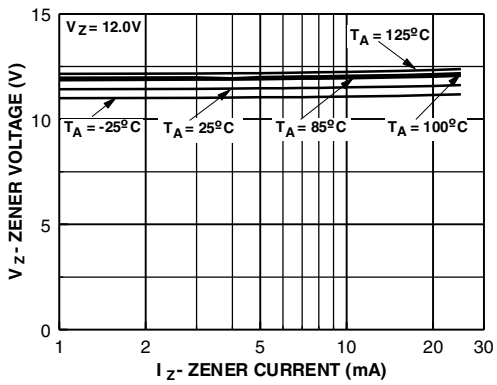

33 Zener Voltage vs. Zener Temperature

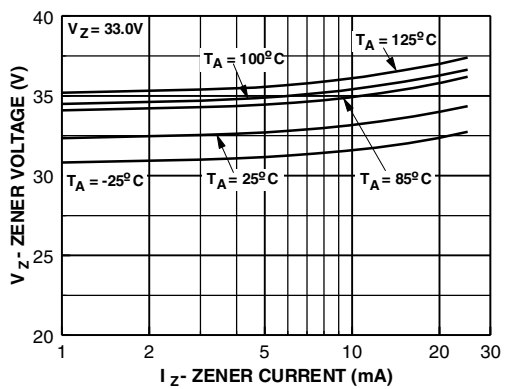

SOD-123 Tape and Reel Data



SOD123 Packaging Configuration: Figure 1.0

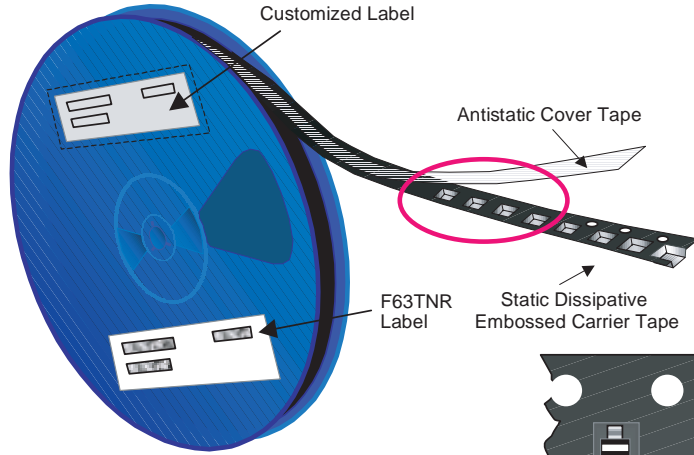

Packaging Description:
 SOD123 parts are shipped in tape. The carrier tape is made from a dissipative (carbon filled) polycarbonate resin. The cover tape is a multilayer film (Heat Activated Adhesive in nature) primarily composed of polyester film, adhesive layer, sealant, and anti-static sprayed agent. These reeled parts in standard option are shipped with 3,000 units per 7" or 177cm diameter reel. The reels are dark blue in color and is made of polystyrene plastic (anti-static coated). Other option comes in 10,000 units per 13" or 330cm diameter reel. This and some other options are described in the Packaging Information table.
 These full reels are individually barcode labeled and placed inside a pizza box (illustrated in figure 1.0) made of recyclable corrugated brown paper with a Fairchild logo printing. One pizza box contains three reels maximum. And these pizza boxes are placed inside a barcode labeled shipping box which comes in different sizes depending on the number of parts shipped.

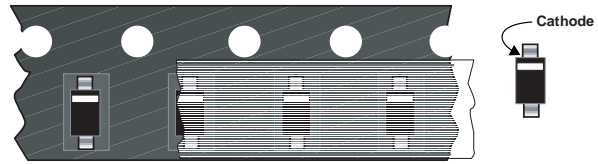

SOD123 Unit Orientation

SOD123 Packaging Information			
Packaging Option	Standard (no flow code)	L99Z	D87Z
Packaging type	TNR	TNR	TNR
Qty per Reel/Tube/Bag	3,000	3,000	10,000
Reel Size	7" Dia	7" Dia	13"
Box Dimension (mm)	184x187x47	184x187x47	343x343x64
Max qty per Box	9,000	9,000	30,000
Weight per unit (gm)	0.01	0.01	0.01
Weight per Reel (kg)	0.123	0.123	0.420
Note/Comments		No marking required	

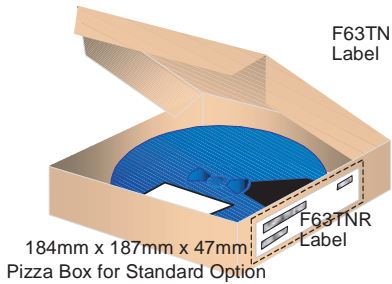
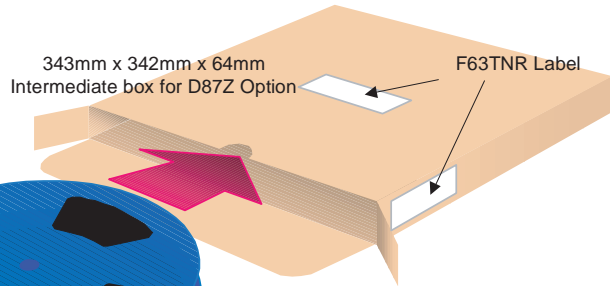

F63TNR Label sample



SOD123 Tape Leader and Trailer Configuration: Figure 2.0

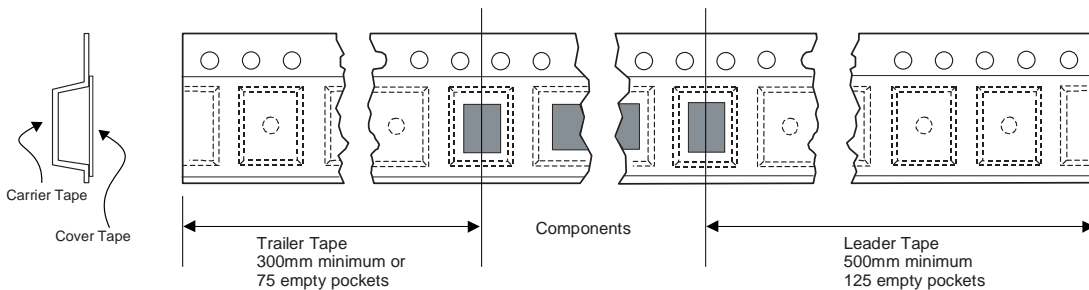

SOD-123 Tape and Reel Data, continued

SOD123 Embossed Carrier Tape Configuration: Figure 3.0

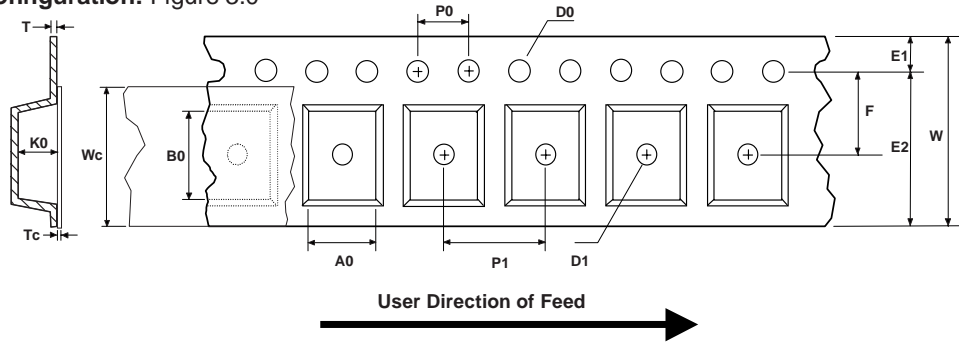

Dimensions are in millimeter														
Pkg type	A0	B0	W	D0	D1	E1	E2	F	P1	P0	K0	T	Wc	Tc
SOD123 (8mm)	1.85 +/-0.10	3.94 +/-0.10	8.0 +/-0.3	1.50 +/-0.10	1.125 +/-0.125	1.75 +/-0.10	6.25 min	3.50 +/-0.05	4.0 +/-0.1	4.0 +/-0.1	1.50 +/-0.10	0.200 +/-0.020	5.2 +/-0.2	0.06 +/-0.02

Notes: A0, B0, and K0 dimensions are determined with respect to the EIA/Jedec RS-481 rotational and lateral movement requirements (see sketches A, B, and C).

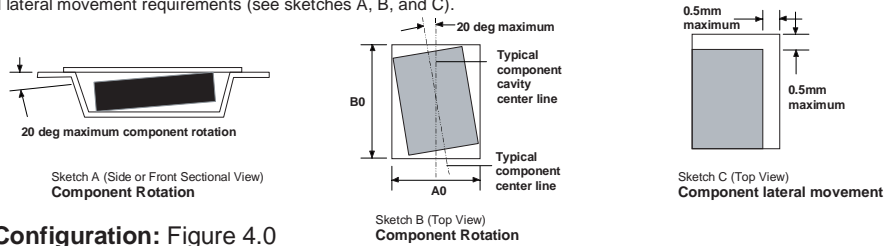

SOD123 Reel Configuration: Figure 4.0

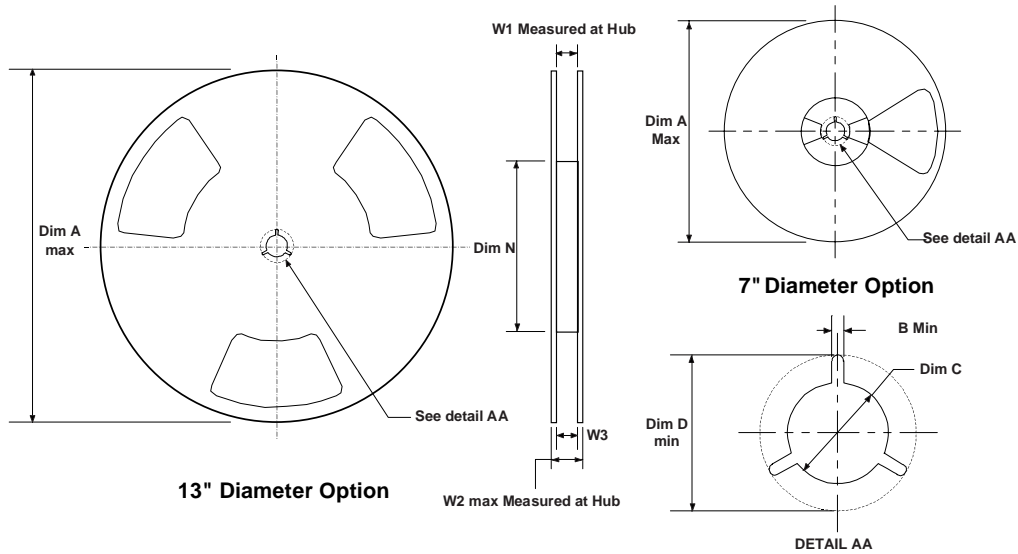

Dimensions are in inches and millimeters									
Tape Size	Reel Option	Dim A	Dim B	Dim C	Dim D	Dim N	Dim W1	Dim W2	Dim W3 (LSL-USL)
8mm	7" Dia	7.00 177.8	0.059 1.5	512 +0.020/-0.008 13 +0.5/-0.2	0.795 20.2	2.165 55	0.331 +0.059/-0.000 8.4 +1.5/0	0.567 14.4	0.311 - 0.429 7.9 - 10.9
8mm	13" Dia	13.00 330	0.059 1.5	512 +0.020/-0.008 13 +0.5/-0.2	0.795 20.2	4.00 100	0.331 +0.059/-0.000 8.4 +1.5/0	0.567 14.4	0.311 - 0.429 7.9 - 10.9

SOD-123 Package Dimensions



SOD-123 (FS PKG Code D6)

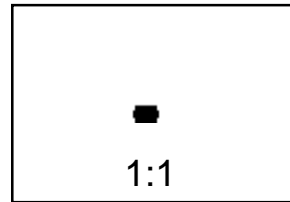

Scale 1:1 on letter size paper

Dimensions shown below are in:
inches [millimeters]

Part Weight per unit (gram): 0.01

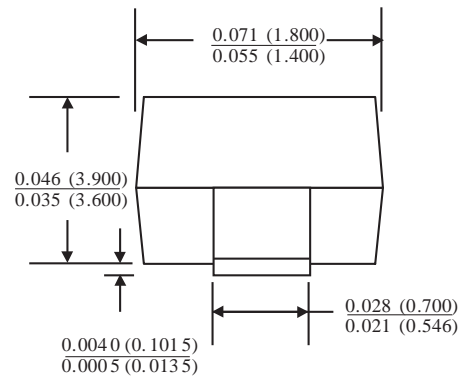
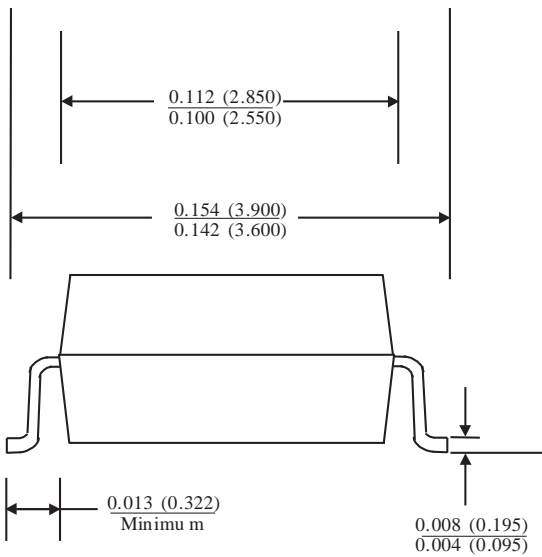
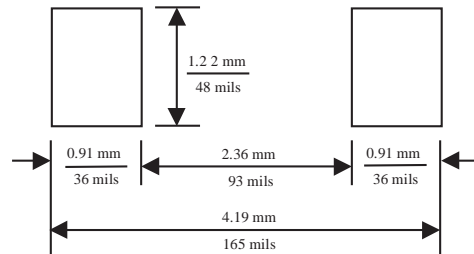
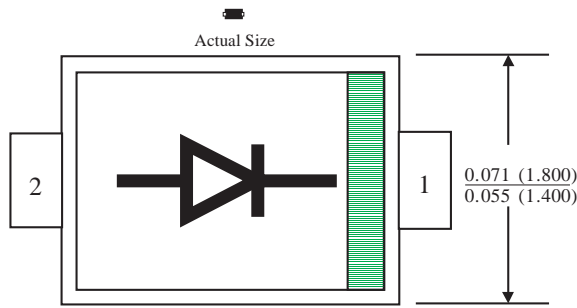

TRADEMARKS

The following are registered and unregistered trademarks Fairchild Semiconductor owns or is authorized to use and is not intended to be an exhaustive list of all such trademarks.

ACE ^x TM	FAST ^r TM	PowerTrench [®]	SyncFET TM
Bottomless TM	GlobalOptoisolator TM	QFET TM	TinyLogic TM
CoolFET TM	GTO TM	QS TM	UHC TM
CROSSVOLT TM	HiSeC TM	QT Optoelectronics TM	VCX TM
DO ^M E TM	ISOP ^L ANAR TM	Quiet Series TM	
E ² CMOS TM	MICROWIRE TM	SILENT SWITCHER [®]	
EnSigna TM	OPTOLOGIC TM	SMART START TM	
FACT TM	OPTOPLANAR TM	SuperSOT TM -3	
FACT Quiet Series TM	PACMAN TM	SuperSOT TM -6	
FAST [®]	POP TM	SuperSOT TM -8	

DISCLAIMER

FAIRCHILD SEMICONDUCTOR RESERVES THE RIGHT TO MAKE CHANGES WITHOUT FURTHER NOTICE TO ANY PRODUCTS HEREIN TO IMPROVE RELIABILITY, FUNCTION OR DESIGN. FAIRCHILD DOES NOT ASSUME ANY LIABILITY ARISING OUT OF THE APPLICATION OR USE OF ANY PRODUCT OR CIRCUIT DESCRIBED HEREIN; NEITHER DOES IT CONVEY ANY LICENSE UNDER ITS PATENT RIGHTS, NOR THE RIGHTS OF OTHERS.

LIFE SUPPORT POLICY

FAIRCHILD'S PRODUCTS ARE NOT AUTHORIZED FOR USE AS CRITICAL COMPONENTS IN LIFE SUPPORT DEVICES OR SYSTEMS WITHOUT THE EXPRESS WRITTEN APPROVAL OF FAIRCHILD SEMICONDUCTOR CORPORATION. As used herein:

1. Life support devices or systems are devices or systems which, (a) are intended for surgical implant into the body, or (b) support or sustain life, or (c) whose failure to perform when properly used in accordance with instructions for use provided in the labeling, can be reasonably expected to result in significant injury to the user.
2. A critical component is any component of a life support device or system whose failure to perform can be reasonably expected to cause the failure of the life support device or system, or to affect its safety or effectiveness.

PRODUCT STATUS DEFINITIONS

Definition of Terms

Datasheet Identification	Product Status	Definition
Advance Information	Formative or In Design	This datasheet contains the design specifications for product development. Specifications may change in any manner without notice.
Preliminary	First Production	This datasheet contains preliminary data, and supplementary data will be published at a later date. Fairchild Semiconductor reserves the right to make changes at any time without notice in order to improve design.
No Identification Needed	Full Production	This datasheet contains final specifications. Fairchild Semiconductor reserves the right to make changes at any time without notice in order to improve design.
Obsolete	Not In Production	This datasheet contains specifications on a product that has been discontinued by Fairchild semiconductor. The datasheet is printed for reference information only.