

# Amplifier Transistors

## PNP Silicon

**BC327,-16,-25**  
**BC328,-16,-25**

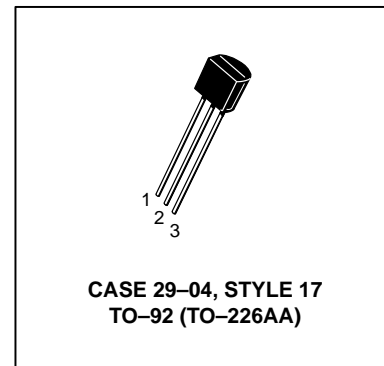
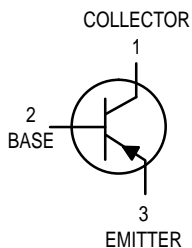

### MAXIMUM RATINGS

Rating	Symbol	BC327	BC328	Unit
Collector–Emitter Voltage	$V_{CEO}$	-45	-25	Vdc
Collector–Base Voltage	$V_{CBO}$	-50	-30	Vdc
Emitter–Base Voltage	$V_{EBO}$	-5.0		Vdc
Collector Current — Continuous	$I_C$	-800		mAdc
Total Device Dissipation @ $T_A = 25^\circ\text{C}$ Derate above $25^\circ\text{C}$	$P_D$	625	5.0	mW mW/ $^\circ\text{C}$
Total Device Dissipation @ $T_C = 25^\circ\text{C}$ Derate above $25^\circ\text{C}$	$P_D$	1.5	12	Watt mW/ $^\circ\text{C}$
Operating and Storage Junction Temperature Range	$T_J, T_{stg}$	-55 to +150		$^\circ\text{C}$

### THERMAL CHARACTERISTICS

Characteristic	Symbol	Max	Unit
Thermal Resistance, Junction to Ambient	$R_{\theta JA}$	200	$^\circ\text{C}/\text{W}$
Thermal Resistance, Junction to Case	$R_{\theta JC}$	83.3	$^\circ\text{C}/\text{W}$

### ELECTRICAL CHARACTERISTICS ( $T_A = 25^\circ\text{C}$ unless otherwise noted)

Characteristic	Symbol	Min	Typ	Max	Unit
----------------	--------	-----	-----	-----	------

### OFF CHARACTERISTICS

Collector–Emitter Breakdown Voltage ( $I_C = -10\text{ mA}, I_B = 0$ )	BC327 BC328	$V_{(BR)CEO}$	-45 -25	— —	— —	Vdc
Collector–Emitter Breakdown Voltage ( $I_C = -100\ \mu\text{A}, I_E = 0$ )	BC327 BC328	$V_{(BR)CES}$	-50 -30	— —	— —	Vdc
Emitter–Base Breakdown Voltage ( $I_E = -10\ \mu\text{A}, I_C = 0$ )		$V_{(BR)EBO}$	-5.0	—	—	Vdc
Collector Cutoff Current ( $V_{CB} = -30\text{ V}, I_E = 0$ ) ( $V_{CB} = -20\text{ V}, I_E = 0$ )	BC327 BC328	$I_{CBO}$	— —	— —	-100 -100	nAdc
Collector Cutoff Current ( $V_{CE} = -45\text{ V}, V_{BE} = 0$ ) ( $V_{CE} = -25\text{ V}, V_{BE} = 0$ )	BC327 BC328	$I_{CES}$	— —	— —	-100 -100	nAdc
Emitter Cutoff Current ( $V_{EB} = -4.0\text{ V}, I_C = 0$ )		$I_{EBO}$	—	—	-100	nAdc

# BC327,-16,-25 BC328,-16,-25

## ELECTRICAL CHARACTERISTICS (T<sub>A</sub> = 25°C unless otherwise noted) (Continued)

Characteristic	Symbol	Min	Typ	Max	Unit
<b>ON CHARACTERISTICS</b>					
DC Current Gain (I <sub>C</sub> = -100 mA, V <sub>CE</sub> = -1.0 V)	h <sub>FE</sub>	BC327/BC328	100	—	630
		BC327-16/BC328-16	100	—	250
		BC327-25/BC328-25	160	—	400
(I <sub>C</sub> = -300 mA, V <sub>CE</sub> = -1.0 V)		40	—	—	
Base-Emitter On Voltage (I <sub>C</sub> = -300 mA, V <sub>CE</sub> = -1.0 V)	V <sub>BE(on)</sub>	—	—	-1.2	Vdc
Collector-Emitter Saturation Voltage (I <sub>C</sub> = -500 mA, I <sub>B</sub> = -50 mA)	V <sub>CE(sat)</sub>	—	—	-0.7	Vdc
<b>SMALL-SIGNAL CHARACTERISTICS</b>					
Output Capacitance (V <sub>CB</sub> = -10 V, I <sub>E</sub> = 0, f = 1.0 MHz)	C <sub>ob</sub>	—	11	—	pF
Current-Gain — Bandwidth Product (I <sub>C</sub> = -10 mA, V <sub>CE</sub> = -5.0 V, f = 100 MHz)	f <sub>T</sub>	—	260	—	MHz

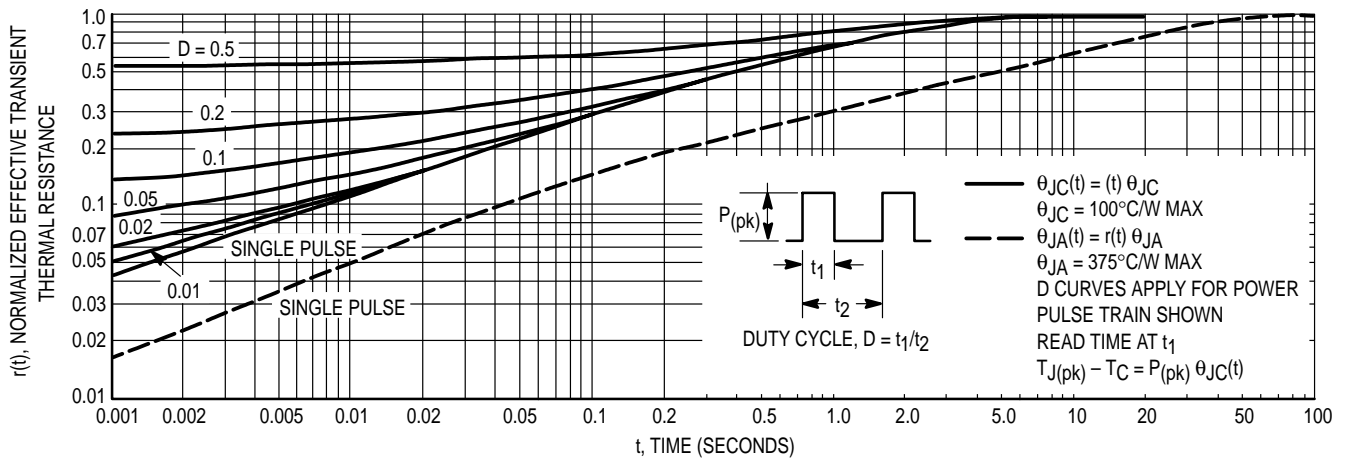

Figure 1. Thermal Response

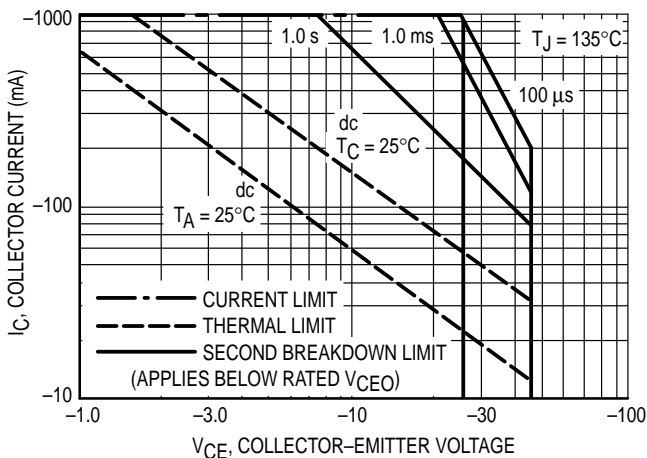

Figure 2. Active Region — Safe Operating Area

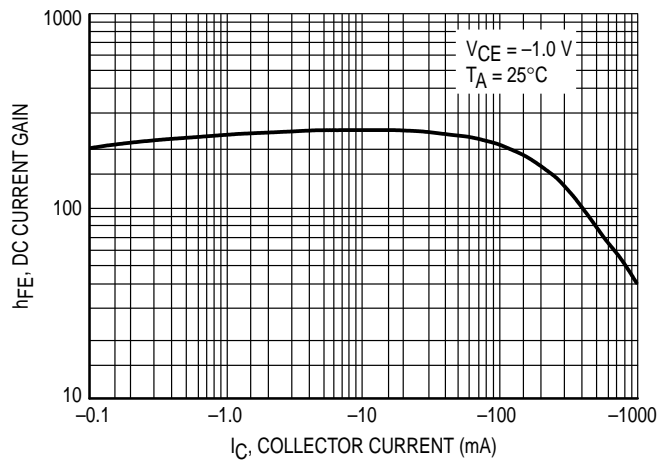

Figure 3. DC Current Gain

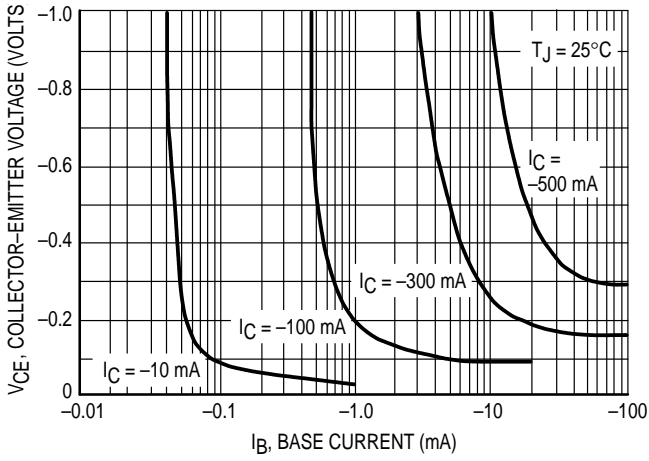

Figure 4. Saturation Region

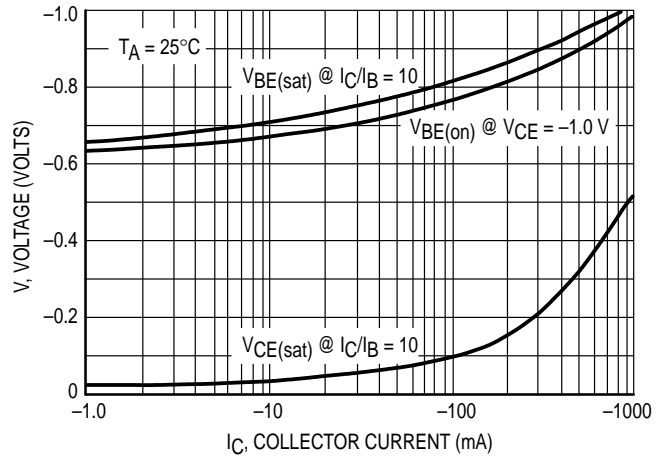

Figure 5. "On" Voltages

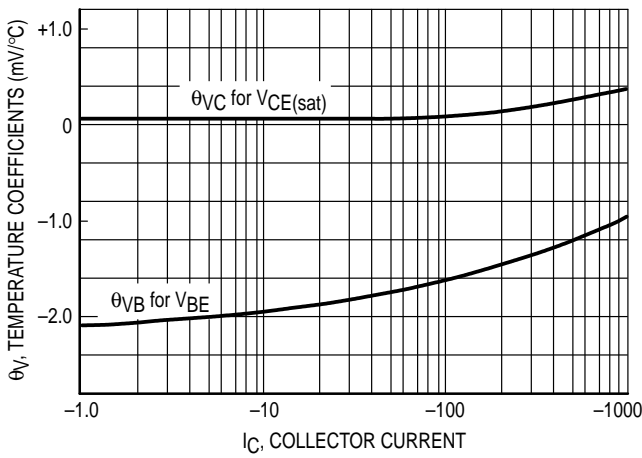

Figure 6. Temperature Coefficients

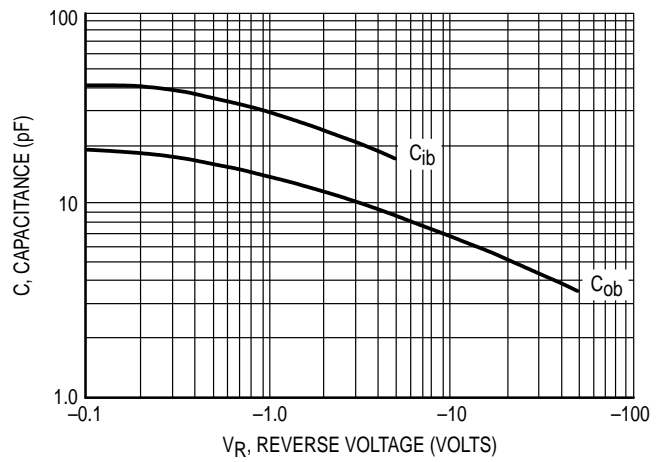

Figure 7. Capacitances

PACKAGE DIMENSIONS



- NOTES:
1. DIMENSIONING AND TOLERANCING PER ANSI Y14.5M, 1982.
  2. CONTROLLING DIMENSION: INCH.
  3. CONTOUR OF PACKAGE BEYOND DIMENSION R IS UNCONTROLLED.
  4. DIMENSION F APPLIES BETWEEN P AND L. DIMENSION D AND J APPLY BETWEEN L AND K. MINIMUM LEAD DIMENSION IS UNCONTROLLED IN P AND BEYOND DIMENSION K MINIMUM.

DIM	INCHES		MILLIMETERS	
	MIN	MAX	MIN	MAX
A	0.175	0.205	4.45	5.20
B	0.170	0.210	4.32	5.33
C	0.125	0.165	3.18	4.19
D	0.016	0.022	0.41	0.55
F	0.016	0.019	0.41	0.48
G	0.045	0.055	1.15	1.39
H	0.095	0.105	2.42	2.66
J	0.015	0.020	0.39	0.50
K	0.500	—	12.70	—
L	0.250	—	6.35	—
N	0.080	0.105	2.04	2.66
P	—	0.100	—	2.54
R	0.115	—	2.93	—
V	0.135	—	3.43	—

CASE 029-04  
(TO-226AA)  
ISSUE AD

STYLE 17:  
PIN 1. COLLECTOR  
2. BASE  
3. EMITTER

Motorola reserves the right to make changes without further notice to any products herein. Motorola makes no warranty, representation or guarantee regarding the suitability of its products for any particular purpose, nor does Motorola assume any liability arising out of the application or use of any product or circuit, and specifically disclaims any and all liability, including without limitation consequential or incidental damages. "Typical" parameters can and do vary in different applications. All operating parameters, including "Typicals" must be validated for each customer application by customer's technical experts. Motorola does not convey any license under its patent rights nor the rights of others. Motorola products are not designed, intended, or authorized for use as components in systems intended for surgical implant into the body, or other applications intended to support or sustain life, or for any other application in which the failure of the Motorola product could create a situation where personal injury or death may occur. Should Buyer purchase or use Motorola products for any such unintended or unauthorized application, Buyer shall indemnify and hold Motorola and its officers, employees, subsidiaries, affiliates, and distributors harmless against all claims, costs, damages, and expenses, and reasonable attorney fees arising out of, directly or indirectly, any claim of personal injury or death associated with such unintended or unauthorized use, even if such claim alleges that Motorola was negligent regarding the design or manufacture of the part. Motorola and are registered trademarks of Motorola, Inc. Motorola, Inc. is an Equal Opportunity/Affirmative Action Employer.

How to reach us:  
USA/EUROPE: Motorola Literature Distribution;  
P.O. Box 20912; Phoenix, Arizona 85036. 1-800-441-2447

JAPAN: Nippon Motorola Ltd.; Tatsumi-SPD-JLDC, Toshikatsu Otsuki,  
6F Seibu-Butsuryu-Center, 3-14-2 Tatsumi Koto-Ku, Tokyo 135, Japan. 03-3521-8315

MFAX: RMFAX0@email.sps.mot.com - TOUCHTONE (602) 244-6609  
INTERNET: http://Design-NET.com

HONG KONG: Motorola Semiconductors H.K. Ltd.; 8B Tai Ping Industrial Park,  
51 Ting Kok Road, Tai Po, N.T., Hong Kong. 852-26629298

