



Is Now Part of



Datasheet.Directory

ON Semiconductor®

To learn more about ON Semiconductor, please visit our website at
www.onsemi.com

Please note: As part of the Fairchild Semiconductor integration, some of the Fairchild orderable part numbers will need to change in order to meet ON Semiconductor's system requirements. Since the ON Semiconductor product management systems do not have the ability to manage part nomenclature that utilizes an underscore (_), the underscore (_) in the Fairchild part numbers will be changed to a dash (-). This document may contain device numbers with an underscore (_). Please check the ON Semiconductor website to verify the updated device numbers. The most current and up-to-date ordering information can be found at www.onsemi.com. Please email any questions regarding the system integration to Fairchild_questions@onsemi.com.

ON Semiconductor and the ON Semiconductor logo are trademarks of Semiconductor Components Industries, LLC dba ON Semiconductor or its subsidiaries in the United States and/or other countries. ON Semiconductor owns the rights to a number of patents, trademarks, copyrights, trade secrets, and other intellectual property. A listing of ON Semiconductor's product/patent coverage may be accessed at www.onsemi.com/site/pdf/Patent-Marking.pdf. ON Semiconductor reserves the right to make changes without further notice to any products herein. ON Semiconductor makes no warranty, representation or guarantee regarding the suitability of its products for any particular purpose, nor does ON Semiconductor assume any liability arising out of the application or use of any product or circuit, and specifically disclaims any and all liability, including without limitation special, consequential or incidental damages. Buyer is responsible for its products and applications using ON Semiconductor products, including compliance with all laws, regulations and safety requirements or standards, regardless of any support or applications information provided by ON Semiconductor. "Typical" parameters which may be provided in ON Semiconductor data sheets and/or specifications can and do vary in different applications and actual performance may vary over time. All operating parameters, including "Typicals" must be validated for each customer application by customer's technical experts. ON Semiconductor does not convey any license under its patent rights nor the rights of others. ON Semiconductor products are not designed, intended, or authorized for use as a critical component in life support systems or any FDA Class 3 medical devices or medical devices with a same or similar classification in a foreign jurisdiction or any devices intended for implantation in the human body. Should Buyer purchase or use ON Semiconductor products for any such unintended or unauthorized application, Buyer shall indemnify and hold ON Semiconductor and its officers, employees, subsidiaries, affiliates, and distributors harmless against all claims, costs, damages, and expenses, and reasonable attorney fees arising out of, directly or indirectly, any claim of personal injury or death associated with such unintended or unauthorized use, even if such claim alleges that ON Semiconductor was negligent regarding the design or manufacture of the part. ON Semiconductor is an Equal Opportunity/Affirmative Action Employer. This literature is subject to all applicable copyright laws and is not for resale in any manner.

FDG6332C_F085

20V N & P-Channel PowerTrench® MOSFETs

Features

- **Q1** 0.7 A, 20V. $R_{DS(ON)} = 300\text{ m}\Omega @ V_{GS} = 4.5\text{ V}$
 $R_{DS(ON)} = 400\text{ m}\Omega @ V_{GS} = 2.5\text{ V}$
- **Q2** -0.6 A, -20V. $R_{DS(ON)} = 420\text{ m}\Omega @ V_{GS} = -4.5\text{ V}$
 $R_{DS(ON)} = 630\text{ m}\Omega @ V_{GS} = -2.5\text{ V}$
- Low gate charge
- High performance trench technology for extremely low $R_{DS(ON)}$
- SC70-6 package: small footprint (51% smaller than SSOT-6); low profile (1mm thick)
- Qualified to AEC Q101
- RoHS Compliant

General Description

The N & P-Channel MOSFETs are produced using Fairchild Semiconductor's advanced PowerTrench process that has been especially tailored to minimize on-state resistance and yet maintain superior switching performance.

These devices have been designed to offer exceptional power dissipation in a very small footprint for applications where the bigger more expensive TSSOP-8 and SSOP-6 packages are impractical.

Applications

- DC/DC converter
- Load switch
- LCD display inverter

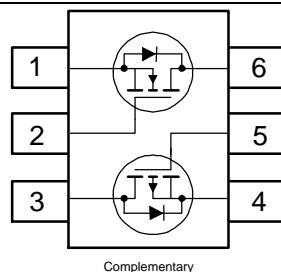
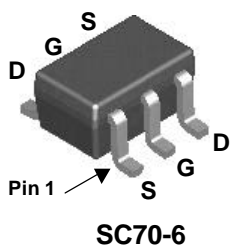

Absolute Maximum Ratings T_A=25°C unless otherwise noted

Symbol	Parameter	Q1	Q2	Units
V _{DSS}	Drain-Source Voltage	20	-20	V
V _{GSS}	Gate-Source Voltage	±12	±12	V
I _D	Drain Current – Continuous (Note 1)	0.7	-0.6	A
	– Pulsed	2.1	-2	
P _D	Power Dissipation for Single Operation (Note 1)	0.3		W
T _J , T _{STG}	Operating and Storage Junction Temperature Range	-55 to +150		°C

Thermal Characteristics

R _{θJA}	Thermal Resistance, Junction-to-Ambient (Note 1)	415	°C/W
------------------	--	-----	------

Package Marking and Ordering Information

Device Marking	Device	Reel Size	Tape width	Quantity
.32	FDG6332C_F085	7"	8mm	3000 units

Electrical Characteristics $T_A = 25^\circ\text{C}$ unless otherwise noted

Symbol	Parameter	Test Conditions	Min	Typ	Max	Units
Off Characteristics						
BV_{DSS}	Drain–Source Breakdown Voltage	$V_{GS} = 0\text{ V}, I_D = 250\ \mu\text{A}$ $V_{GS} = 0\text{ V}, I_D = -250\ \mu\text{A}$	Q1 20 Q2 -20			V
$\frac{\Delta BV_{DSS}}{\Delta T_J}$	Breakdown Voltage Temperature Coefficient	$I_D = 250\ \mu\text{A}, \text{Ref. to } 25^\circ\text{C}$ $I_D = -250\ \mu\text{A}, \text{Ref. to } 25^\circ\text{C}$	Q1 Q2	14 -14		mV/°C
I_{DSS}	Zero Gate Voltage Drain Current	$V_{DS} = 16\text{ V}, V_{GS} = 0\text{ V}$ $V_{DS} = -16\text{ V}, V_{GS} = 0\text{ V}$	Q1 Q2		1 -1	μA
I_{GSSF} / I_{GSSR}	Gate–Body Leakage, Forward	$V_{GS} = \pm 12\text{ V}, V_{DS} = 0\text{ V}$			± 100	nA
I_{GSSF} / I_{GSSR}	Gate–Body Leakage, Reverse	$V_{GS} = \pm 12\text{ V}, V_{DS} = 0\text{ V}$			± 100	nA
On Characteristics (Note 2)						
$V_{GS(th)}$	Gate Threshold Voltage	Q1 $V_{DS} = V_{GS}, I_D = 250\ \mu\text{A}$ Q2 $V_{DS} = V_{GS}, I_D = -250\ \mu\text{A}$	0.6 -0.6	1.1 -1.2	1.5 -1.5	V
$\frac{\Delta V_{GS(th)}}{\Delta T_J}$	Gate Threshold Voltage Temperature Coefficient	Q1 $I_D = 250\ \mu\text{A}, \text{Ref. To } 25^\circ\text{C}$ Q2 $I_D = -250\ \mu\text{A}, \text{Ref. to } 25^\circ\text{C}$		-2.8 3		mV/°C
$R_{DS(on)}$	Static Drain–Source On–Resistance	Q1 $V_{GS} = 4.5\text{ V}, I_D = 0.7\text{ A}$ $V_{GS} = 2.5\text{ V}, I_D = 0.6\text{ A}$ $V_{GS} = 4.5\text{ V}, I_D = 0.7\text{ A}, T_J = 125^\circ\text{C}$ Q2 $V_{GS} = -4.5\text{ V}, I_D = -0.6\text{ A}$ $V_{GS} = -2.5\text{ V}, I_D = -0.5\text{ A}$ $V_{GS} = -4.5\text{ V}, I_D = -0.6\text{ A}, T_J = 125^\circ\text{C}$		180 293 247	300 400 442	m Ω
g_{FS}	Forward Transconductance	Q1 $V_{DS} = 5\text{ V}, I_D = 0.7\text{ A}$ Q2 $V_{DS} = -5\text{ V}, I_D = -0.6\text{ A}$		2.8 1.8		S
$I_{D(on)}$	On–State Drain Current	Q1 $V_{GS} = 4.5\text{ V}, V_{DS} = 5\text{ V}$ Q2 $V_{GS} = -4.5\text{ V}, V_{DS} = -5\text{ V}$	1 -2			A
Dynamic Characteristics						
C_{iss}	Input Capacitance	Q1 $V_{DS} = 10\text{ V}, V_{GS} = 0\text{ V}, f = 1.0\text{ MHz}$ Q2 $V_{DS} = -10\text{ V}, V_{GS} = 0\text{ V}, f = 1.0\text{ MHz}$		113 114		pF
C_{oss}	Output Capacitance	Q1 $V_{DS} = 10\text{ V}, V_{GS} = 0\text{ V}, f = 1.0\text{ MHz}$ Q2 $V_{DS} = -10\text{ V}, V_{GS} = 0\text{ V}, f = 1.0\text{ MHz}$		34 24		pF
C_{rss}	Reverse Transfer Capacitance	Q1 $V_{DS} = 10\text{ V}, V_{GS} = 0\text{ V}, f = 1.0\text{ MHz}$ Q2 $V_{DS} = -10\text{ V}, V_{GS} = 0\text{ V}, f = 1.0\text{ MHz}$		16 9		pF
Switching Characteristics (Note 2)						
$t_{d(on)}$	Turn–On Delay Time	Q1 For Q1 : $V_{DS} = 10\text{ V}, I_D = 1\text{ A}$ $V_{GS} = 4.5\text{ V}, R_{GEN} = 6\ \Omega$ Q2 For Q2 : $V_{DS} = -10\text{ V}, I_D = -1\text{ A}$ $V_{GS} = -4.5\text{ V}, R_{GEN} = 6\ \Omega$		5 5.5	10 11	ns
t_r	Turn–On Rise Time			7 14	15 25	ns
$t_{d(off)}$	Turn–Off Delay Time			9 6	18 12	ns
t_f	Turn–Off Fall Time			1.5 1.7	3 3.4	ns
Q_g	Total Gate Charge	Q1 For Q1 : $V_{DS} = 10\text{ V}, I_D = 0.7\text{ A}$ $V_{GS} = 4.5\text{ V}, R_{GEN} = 6\ \Omega$ Q2 For Q2 : $V_{DS} = -10\text{ V}, I_D = -0.6\text{ A}$ $V_{GS} = -4.5\text{ V}, R_{GEN} = 6\ \Omega$		1.1 1.4	1.5 2	nC
Q_{gs}	Gate–Source Charge			0.24 0.3		nC
Q_{gd}	Gate–Drain Charge			0.3 0.4		nC

Electrical Characteristics $T_A = 25^\circ\text{C}$ unless otherwise noted

Symbol	Parameter	Test Conditions	Min	Typ	Max	Units	
Drain–Source Diode Characteristics and Maximum Ratings							
I_S	Maximum Continuous Drain–Source Diode Forward Current	Q1			0.25	A	
		Q2			–0.25		
V_{SD}	Drain–Source Diode Forward Voltage	Q1	$V_{GS} = 0\text{ V}, I_S = 0.25\text{ A}$ (Note 2)		0.74	1.2	V
		Q2	$V_{GS} = 0\text{ V}, I_S = -0.25\text{ A}$ (Note 2)		–0.77	–1.2	

Notes:

1. $R_{\theta JA}$ is the sum of the junction-to-case and case-to-ambient thermal resistance where the case thermal reference is defined as the solder mounting surface of the drain pins. $R_{\theta JC}$ is guaranteed by design while $R_{\theta JA}$ is determined by the user's board design. $R_{\theta JA} = 415^\circ\text{C/W}$ when mounted on a minimum pad of FR-4 PCB in a still air environment.

2. Pulse Test: Pulse Width < 300 μs , Duty Cycle < 2.0%

Typical Characteristics: N-Channel

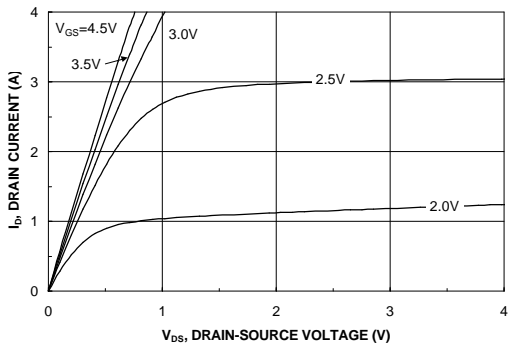

Figure 1. On-Region Characteristics.

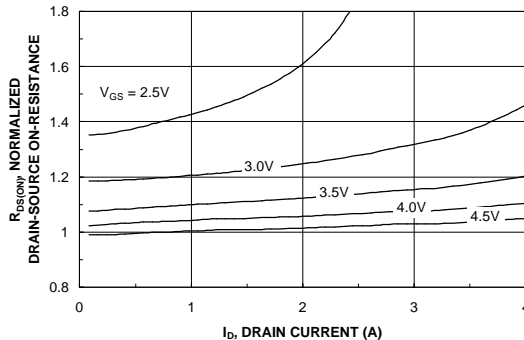

Figure 2. On-Resistance Variation with Drain Current and Gate Voltage.

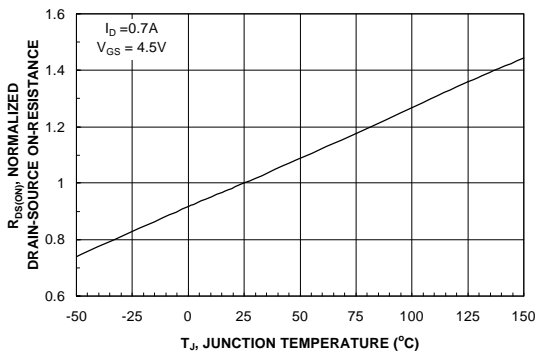

Figure 3. On-Resistance Variation with Temperature.

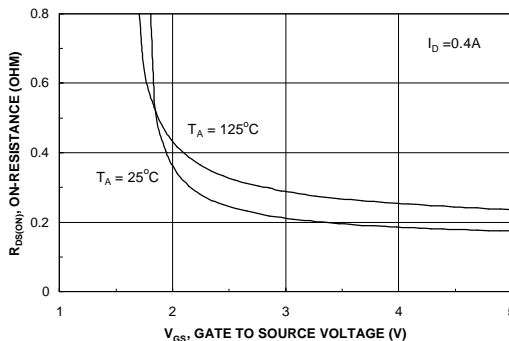

Figure 4. On-Resistance Variation with Gate-to-Source Voltage.

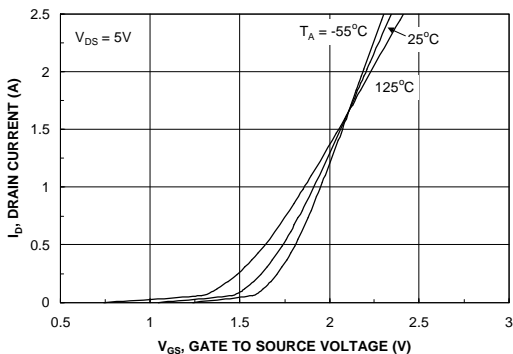

Figure 5. Transfer Characteristics.

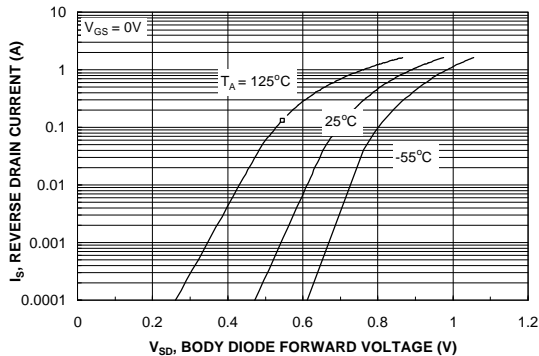

Figure 6. Body Diode Forward Voltage Variation with Source Current and Temperature.

Typical Characteristics: N-Channel

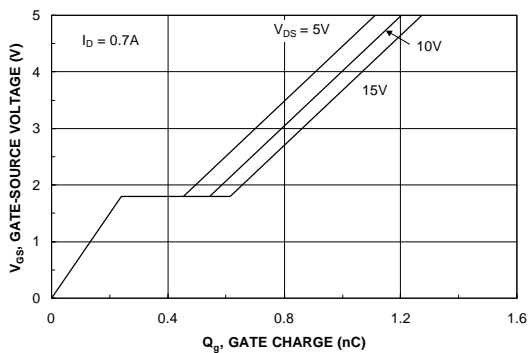

Figure 7. Gate Charge Characteristics.

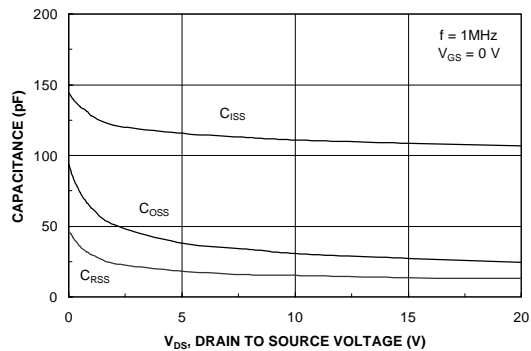

Figure 8. Capacitance Characteristics.

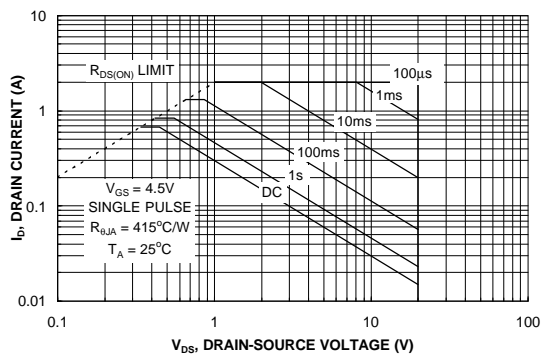

Figure 9. Maximum Safe Operating Area.

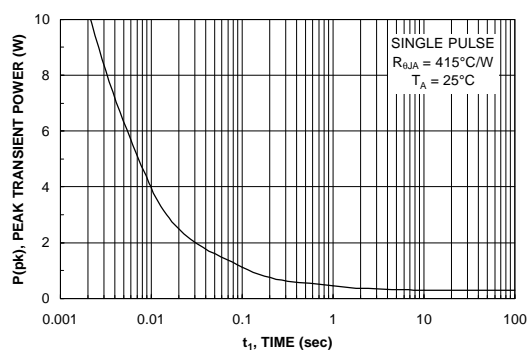

Figure 10. Single Pulse Maximum Power Dissipation.

Typical Characteristics: P-Channel

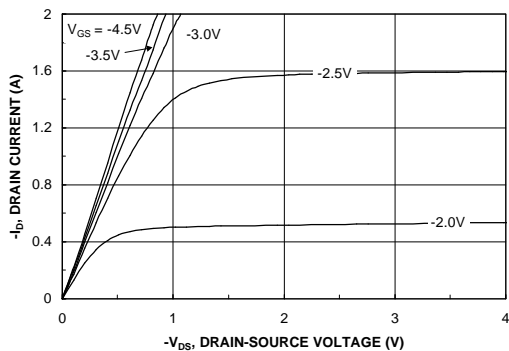

Figure 11. On-Region Characteristics.

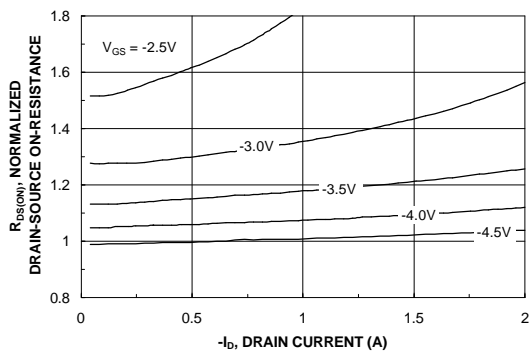

Figure 12. On-Resistance Variation with Drain Current and Gate Voltage.

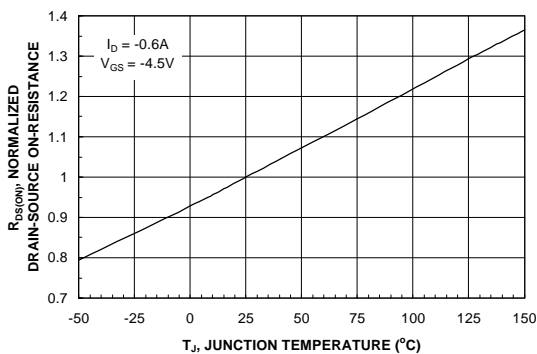

Figure 13. On-Resistance Variation with Temperature.

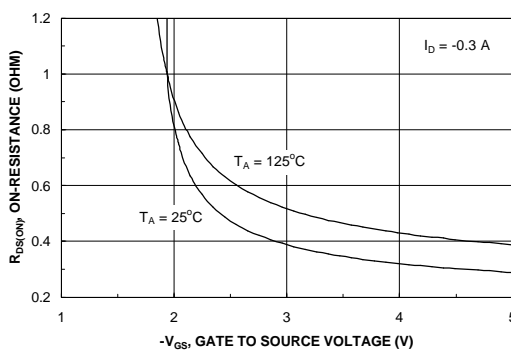

Figure 14. On-Resistance Variation with Gate-to-Source Voltage.

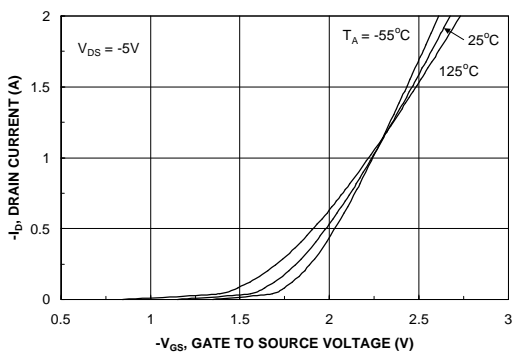

Figure 15. Transfer Characteristics.

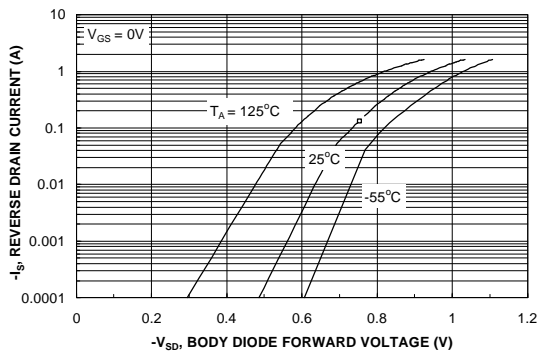

Figure 16. Body Diode Forward Voltage Variation with Source Current and Temperature.

Typical Characteristics: P-Channel

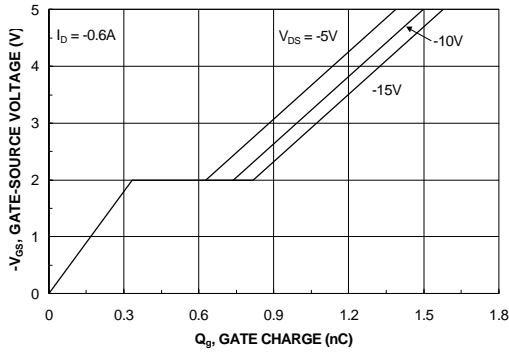

Figure 17. Gate Charge Characteristics.

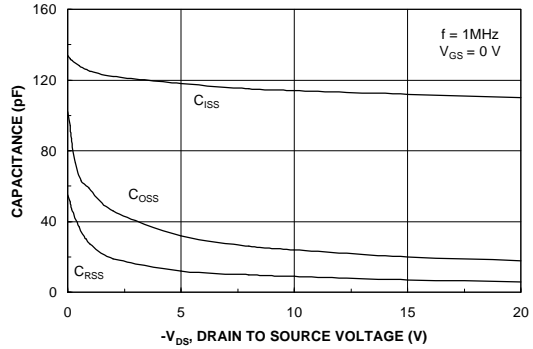

Figure 18. Capacitance Characteristics.

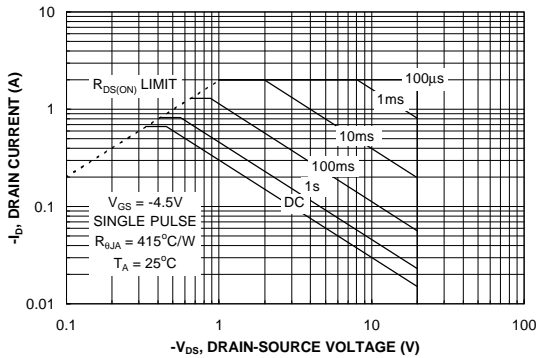

Figure 19. Maximum Safe Operating Area.

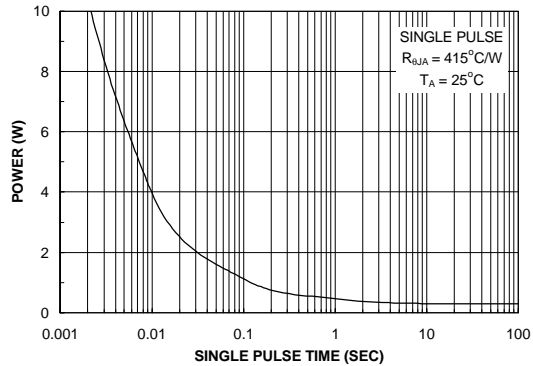

Figure 20. Single Pulse Maximum Power Dissipation.

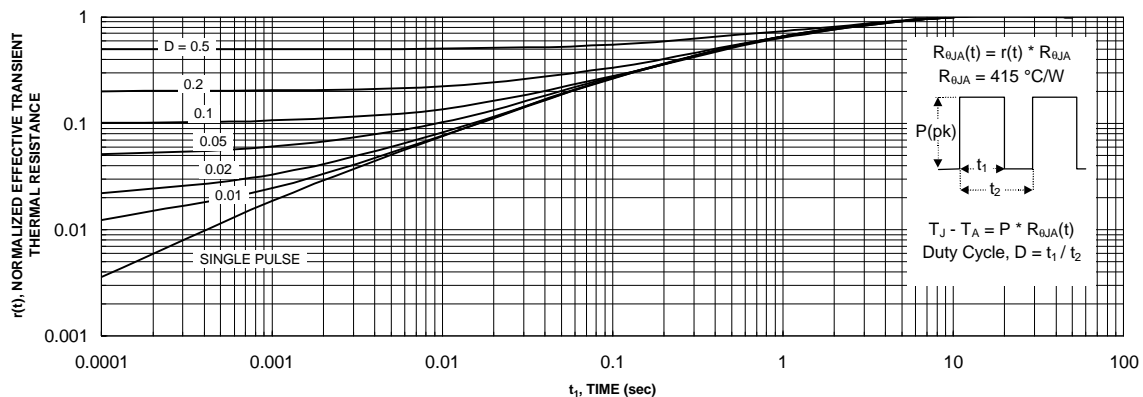
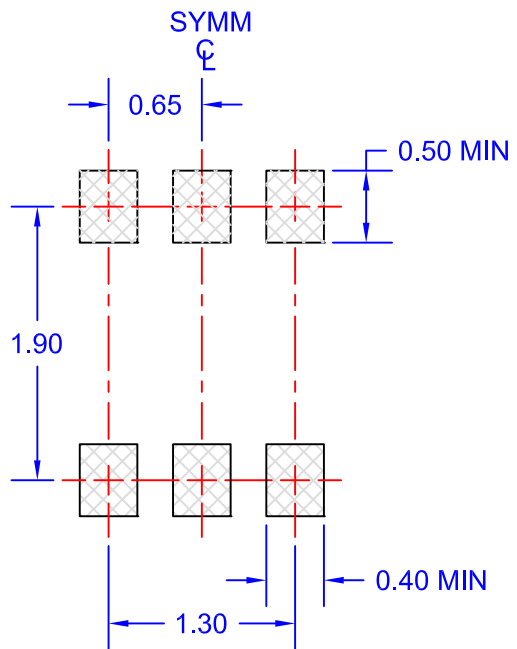
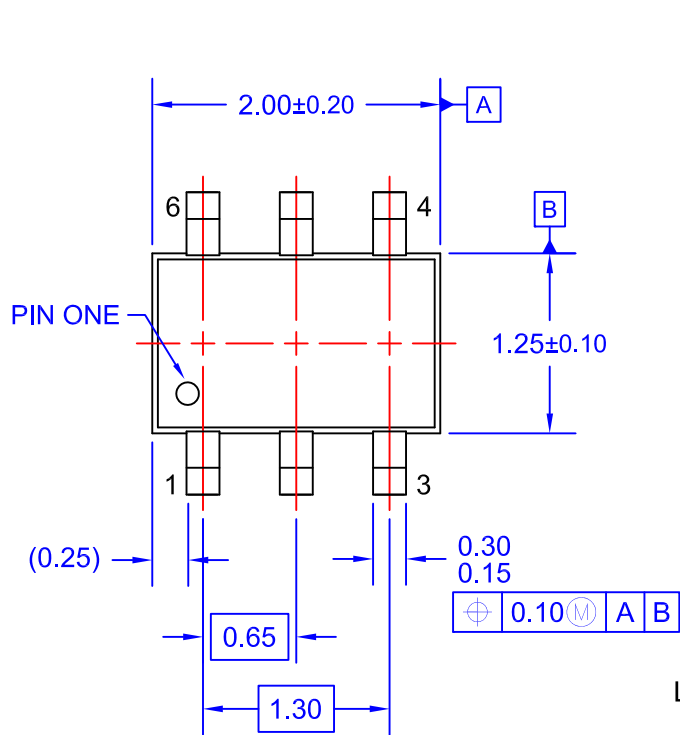
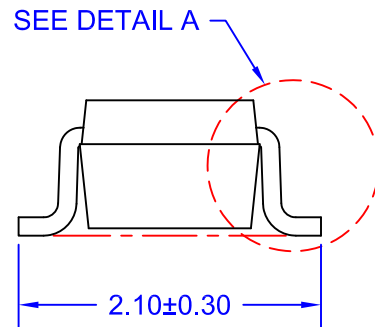
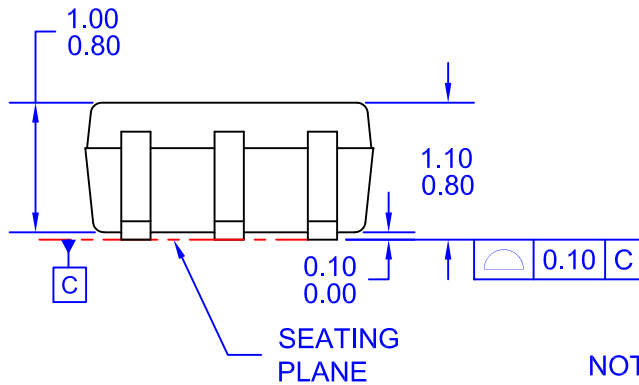

Figure 21. Transient Thermal Response Curve.

Thermal characterization performed using the conditions described in Note 1. Transient thermal response will change depending on the circuit board design.



LAND PATTERN RECOMMENDATION



NOTES: UNLESS OTHERWISE SPECIFIED
 A) THIS PACKAGE CONFORMS TO EIAJ SC-88, 1996.

B) ALL DIMENSIONS ARE IN MILLIMETERS.
 C) DIMENSIONS DO NOT INCLUDE BURRS OR MOLD FLASH.

D) DIMENSIONING AND TOLERANCING PER ASME Y14.5M-2009

E) DRAWING FILENAME: MKT-MAA06AREV7

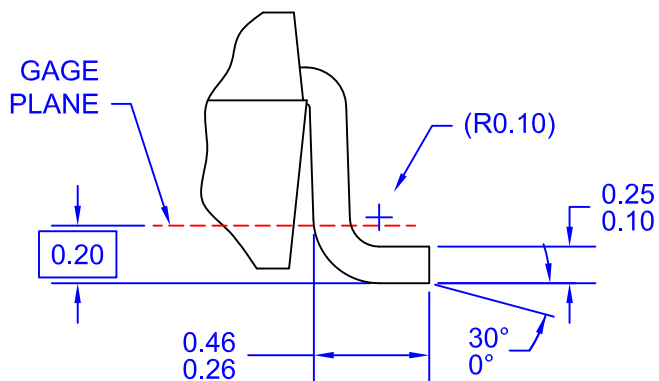

DETAIL A
 SCALE: 60X



ON Semiconductor and  are trademarks of Semiconductor Components Industries, LLC dba ON Semiconductor or its subsidiaries in the United States and/or other countries. ON Semiconductor owns the rights to a number of patents, trademarks, copyrights, trade secrets, and other intellectual property. A listing of ON Semiconductor's product/patent coverage may be accessed at www.onsemi.com/site/pdf/Patent-Marking.pdf. ON Semiconductor reserves the right to make changes without further notice to any products herein. ON Semiconductor makes no warranty, representation or guarantee regarding the suitability of its products for any particular purpose, nor does ON Semiconductor assume any liability arising out of the application or use of any product or circuit, and specifically disclaims any and all liability, including without limitation special, consequential or incidental damages. Buyer is responsible for its products and applications using ON Semiconductor products, including compliance with all laws, regulations and safety requirements or standards, regardless of any support or applications information provided by ON Semiconductor. "Typical" parameters which may be provided in ON Semiconductor data sheets and/or specifications can and do vary in different applications and actual performance may vary over time. All operating parameters, including "Typicals" must be validated for each customer application by customer's technical experts. ON Semiconductor does not convey any license under its patent rights nor the rights of others. ON Semiconductor products are not designed, intended, or authorized for use as a critical component in life support systems or any FDA Class 3 medical devices or medical devices with a same or similar classification in a foreign jurisdiction or any devices intended for implantation in the human body. Should Buyer purchase or use ON Semiconductor products for any such unintended or unauthorized application, Buyer shall indemnify and hold ON Semiconductor and its officers, employees, subsidiaries, affiliates, and distributors harmless against all claims, costs, damages, and expenses, and reasonable attorney fees arising out of, directly or indirectly, any claim of personal injury or death associated with such unintended or unauthorized use, even if such claim alleges that ON Semiconductor was negligent regarding the design or manufacture of the part. ON Semiconductor is an Equal Opportunity/Affirmative Action Employer. This literature is subject to all applicable copyright laws and is not for resale in any manner.

PUBLICATION ORDERING INFORMATION

LITERATURE FULFILLMENT:

Literature Distribution Center for ON Semiconductor
19521 E. 32nd Pkwy, Aurora, Colorado 80011 USA
Phone: 303-675-2175 or 800-344-3860 Toll Free USA/Canada
Fax: 303-675-2176 or 800-344-3867 Toll Free USA/Canada
Email: orderlit@onsemi.com

N. American Technical Support: 800-282-9855 Toll Free
USA/Canada
Europe, Middle East and Africa Technical Support:
Phone: 421 33 790 2910
Japan Customer Focus Center
Phone: 81-3-5817-1050

ON Semiconductor Website: www.onsemi.com
Order Literature: <http://www.onsemi.com/orderlit>
For additional information, please contact your local
Sales Representative