

Surface Mount Schottky Power Rectifier

MBRS360T3G, MBRS360BT3G, NRVBS360T3G, NRVBS360BT3G, NRVBS360BNT3

This device employs the Schottky Barrier principle in a large area metal-to-silicon power diode. State-of-the-art geometry features epitaxial construction with oxide passivation and metal overlay contact. Ideally suited for low voltage, high frequency rectification, or as free wheeling and polarity protection diodes, in surface mount applications where compact size and weight are critical to the system.

Features

- Small Compact Surface Mountable Package with J-Bend Leads
- Rectangular Package for Automated Handling
- Highly Stable Oxide Passivated Junction
- Excellent Ability to Withstand Reverse Avalanche Energy Transients
- Guard-Ring for Stress Protection
- NRVBS Prefix for Automotive and Other Applications Requiring Unique Site and Control Change Requirements; AEC-Q101 Qualified and PPAP Capable*
- These Devices are Pb-Free, Halogen Free/BFR Free and are RoHS Compliant

Mechanical Characteristics

- Case: Epoxy, Molded, Epoxy Meets UL 94 V-0
- Weight: 217 mg (Approximately), SMC
95 mg (Approximately), SMB
- Finish: All External Surfaces Corrosion Resistant and Terminal Leads are Readily Solderable
- Lead and Mounting Surface Temperature for Soldering Purposes: 260°C Max. for 10 Seconds
- Polarity: Polarity Band on Plastic Body Indicates Cathode Lead
- Device Meets MSL 1 Requirements
- ESD Ratings:
 - ◆ Machine Model, C
 - ◆ Human Body Model, 3B



ON Semiconductor®

www.onsemi.com

SCHOTTKY BARRIER RECTIFIERS 3.0 AMPERES, 60 VOLTS



SMC 2-LEAD
CASE 403AC



SMB
CASE 403A-03

MARKING DIAGRAMS

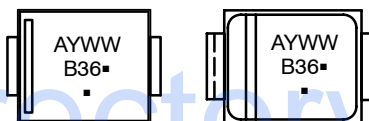

B36 = Specific Device Code
A = Assembly Location**
Y = Year
WW = Work Week
■ = Pb-Free Package

(Note: Microdot may be in either location)

**The Assembly Location code (A) is front side optional. In cases where the Assembly Location is stamped in the package, the front side assembly code may be blank.

ORDERING INFORMATION

Device	Package	Shipping†
MBRS360T3G	SMC (Pb-Free)	2,500 / Tape & Reel
MBRS360BT3G	SMB (Pb-Free)	2,500 / Tape & Reel
NRVBS360T3G*	SMC (Pb-Free)	2,500 / Tape & Reel
NRVBS360BT3G*	SMB (Pb-Free)	2,500 / Tape & Reel
NRVBS360BT3G -VF01*	SMB (Pb-Free)	2,500 / Tape & Reel
NRVBS360BNT3G*	SMB (Pb-Free)	2,500 / Tape & Reel

†For information on tape and reel specifications, including part orientation and tape sizes, please refer to our Tape and Reel Packaging Specification Brochure, BRD8011/D.

MBRS360T3G, MBRS360BT3G, NRVBS360T3G, NRVBS360BT3G, NRVBS360BNT3

MAXIMUM RATINGS

Rating	Symbol	Value	Unit
Peak Repetitive Reverse Voltage Working Peak Reverse Voltage DC Blocking Voltage	V_{RRM} V_{RWM} V_R	60	V
Average Rectified Forward Current	$I_{F(AV)}$	3.0 @ $T_L = 137^\circ\text{C}$ 4.0 @ $T_L = 127^\circ\text{C}$	A
Nonrepetitive Peak Surge Current (Surge applied at rated load conditions halfwave, single phase, 60 Hz)	I_{FSM}	125	A
Storage Temperature Range	T_{stg}	- 65 to +175	$^\circ\text{C}$
Operating Junction Temperature (Note 1)	T_J	- 65 to +175	$^\circ\text{C}$

Stresses exceeding those listed in the Maximum Ratings table may damage the device. If any of these limits are exceeded, device functionality should not be assumed, damage may occur and reliability may be affected.

1. The heat generated must be less than the thermal conductivity from Junction-to-Ambient: $dP_D/dT_J < 1/R_{\theta JA}$.

THERMAL CHARACTERISTICS

Characteristic	Symbol	Value	Unit
Thermal Resistance, Junction-to-Lead (Note 2) SMC Package SMB Package	$R_{\theta JL}$	11 15	$^\circ\text{C/W}$
Thermal Resistance, Junction-to-Ambient (Note 2) SMC Package SMB Package	$R_{\theta JA}$	136 145	$^\circ\text{C/W}$
Thermal Resistance, Junction-to-Ambient (Note 3) SMC Package SMB Package (Note 4)	$R_{\theta JA}$	71 73	$^\circ\text{C/W}$

ELECTRICAL CHARACTERISTICS

Maximum Instantaneous Forward Voltage (Note 5) ($i_F = 3.0\text{ A}$, $T_J = 25^\circ\text{C}$)	V_F	0.63	V
Maximum Instantaneous Reverse Current (Note 5) (Rated dc Voltage, $T_J = 25^\circ\text{C}$) (Rated dc Voltage, $T_J = 100^\circ\text{C}$)	i_R	0.03 3.0	mA

Product parametric performance is indicated in the Electrical Characteristics for the listed test conditions, unless otherwise noted. Product performance may not be indicated by the Electrical Characteristics if operated under different conditions.

- Mounted with minimum recommended pad size, PC Board FR4.
- 1 inch square pad size (1 x 0.5 inch for each lead) on FR4 board.
- Typical Value; 1 inch square pad size (1 x 0.5 inch for each lead) on FR4 board.
- Pulse Test: Pulse Width = 300 μs , Duty Cycle $\leq 2.0\%$.

TYPICAL ELECTRICAL CHARACTERISTICS

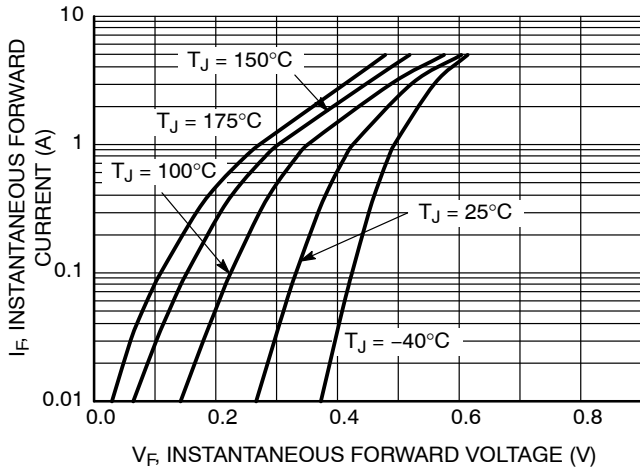

Figure 1. Typical Forward Voltage

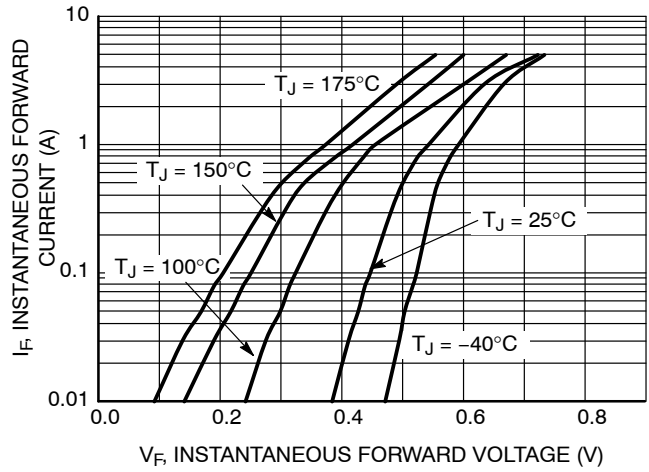

Figure 2. Maximum Forward Voltage

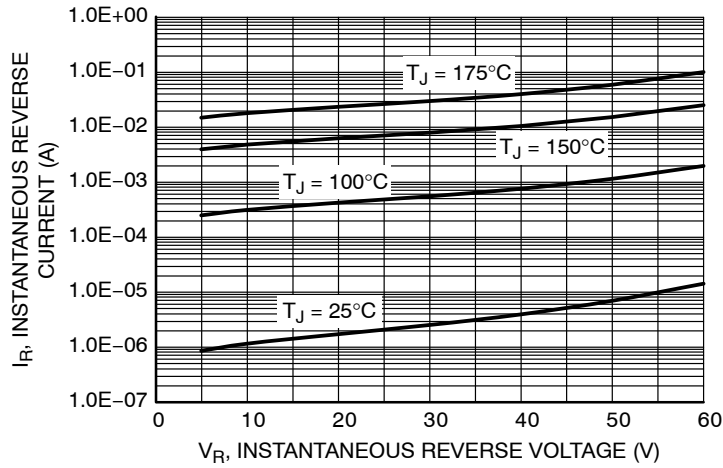

Figure 3. Typical Reverse Current

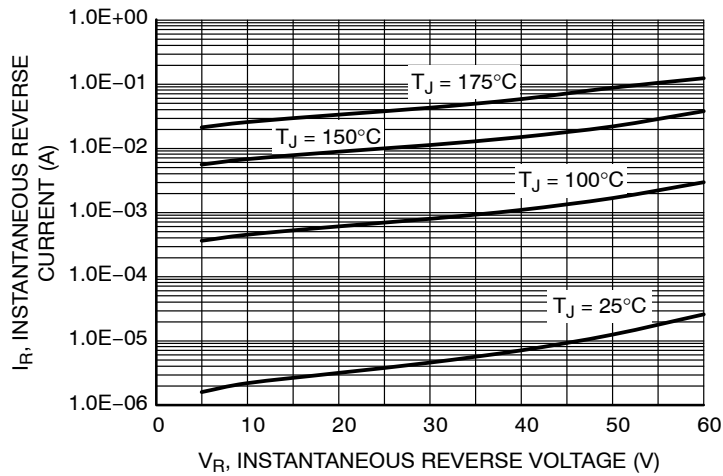

Figure 4. Maximum Reverse Current

MBRS360T3G, MBRS360BT3G, NRVBS360T3G, NRVBS360BT3G, NRVBS360BNT3

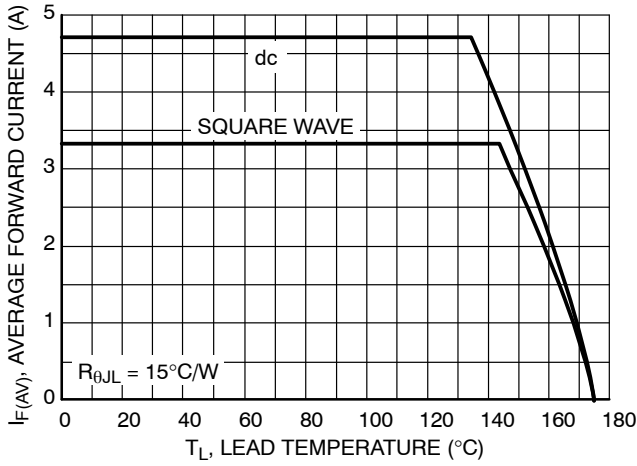

Figure 5. Current Derating

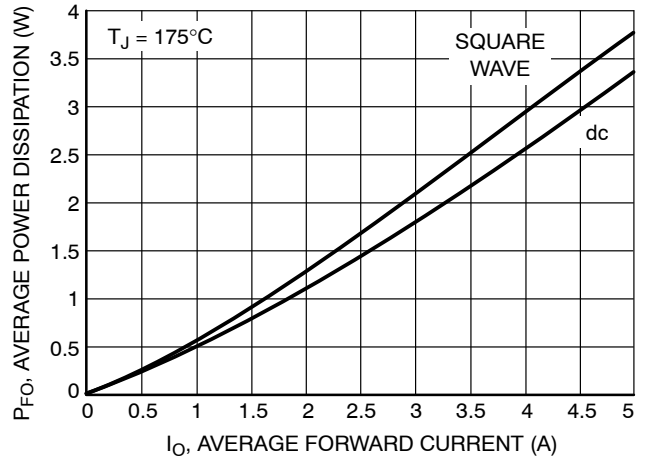

Figure 6. Forward Power Dissipation

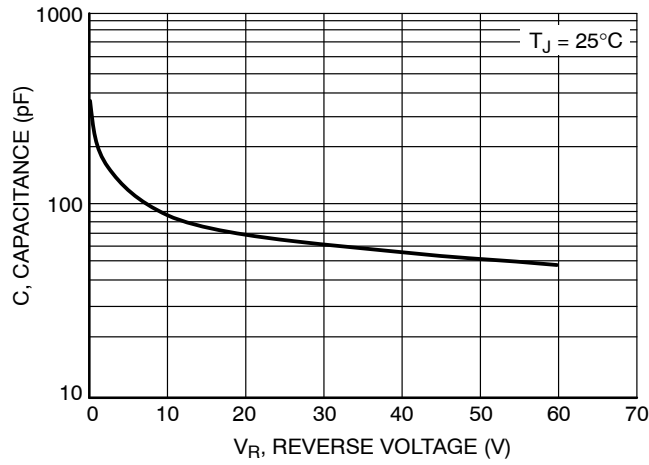

Figure 7. Typical Capacitance

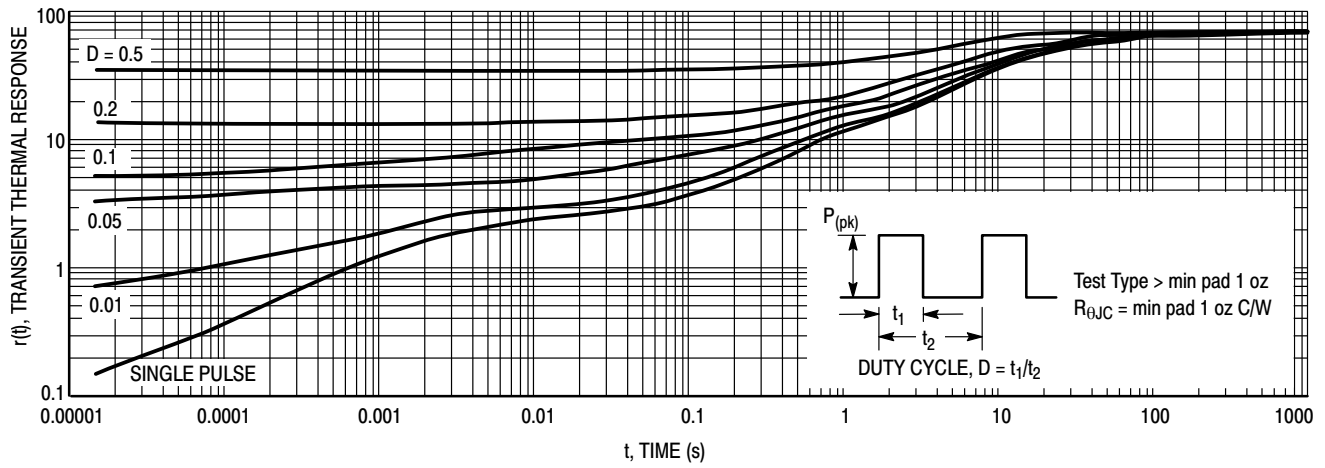

Figure 8. Thermal Response, Junction-to-Ambient, SMC Package

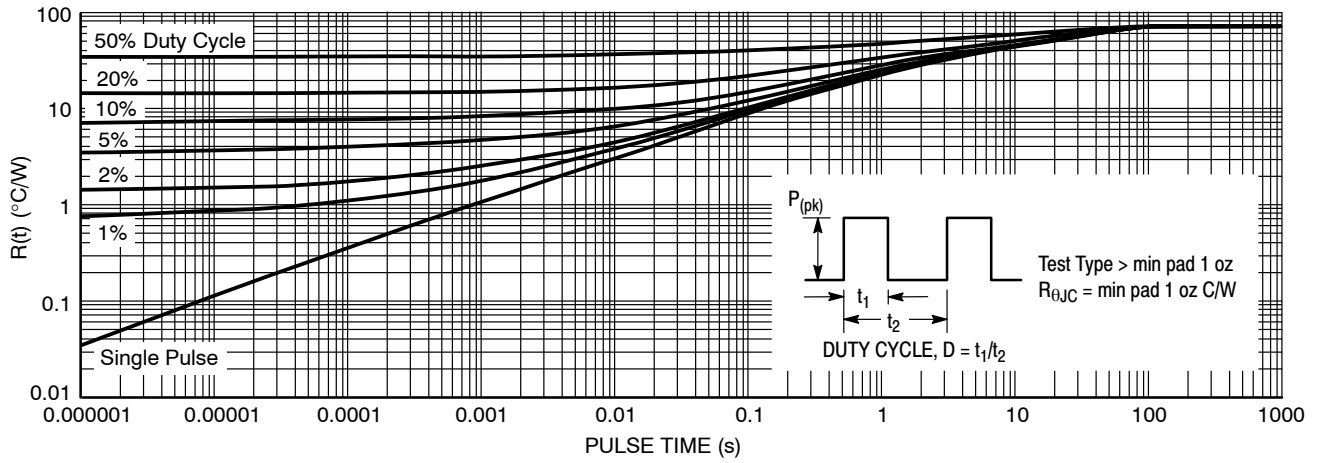

Figure 9. Typical Thermal Response, Junction-to-Ambient, SMB Package

MECHANICAL CASE OUTLINE

PACKAGE DIMENSIONS

ON Semiconductor®



SCALE 1:1

Polarity Band



SCALE 1:1

Non-Polarity Band

SMB
CASE 403A-03
ISSUE J

DATE 19 JUL 2012

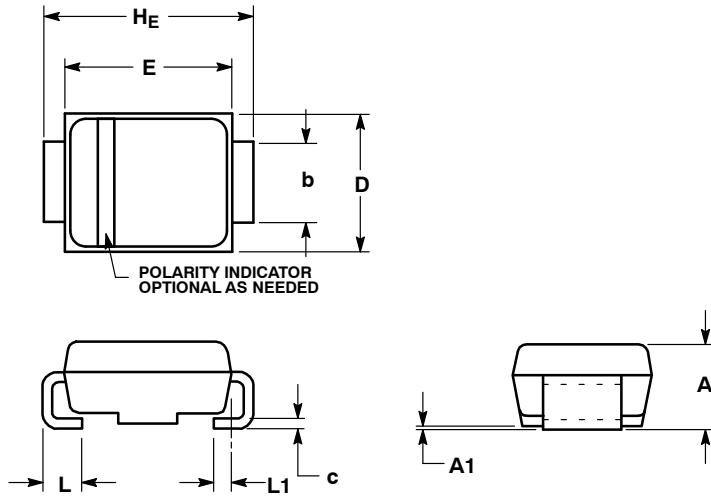

NOTES:

1. DIMENSIONING AND TOLERANCING PER ANSI Y14.5M, 1982.
2. CONTROLLING DIMENSION: INCH.
3. DIMENSION b SHALL BE MEASURED WITHIN DIMENSION L1.

DIM	MILLIMETERS			INCHES		
	MIN	NOM	MAX	MIN	NOM	MAX
A	1.95	2.30	2.47	0.077	0.091	0.097
A1	0.05	0.10	0.20	0.002	0.004	0.008
b	1.96	2.03	2.20	0.077	0.080	0.087
c	0.15	0.23	0.31	0.006	0.009	0.012
D	3.30	3.56	3.95	0.130	0.140	0.156
E	4.06	4.32	4.60	0.160	0.170	0.181
HE	5.21	5.44	5.60	0.205	0.214	0.220
L	0.76	1.02	1.60	0.030	0.040	0.063
L1	0.51 REF			0.020 REF		

GENERIC MARKING DIAGRAM*

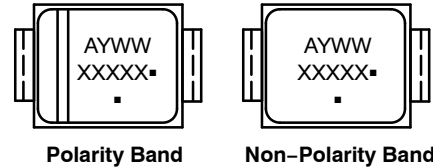

- XXXXX = Specific Device Code
 - A = Assembly Location
 - Y = Year
 - WW = Work Week
 - = Pb-Free Package
- (Note: Microdot may be in either location)

*This information is generic. Please refer to device data sheet for actual part marking. Pb-Free indicator, "G" or microdot "▪", may or may not be present.

SOLDERING FOOTPRINT*

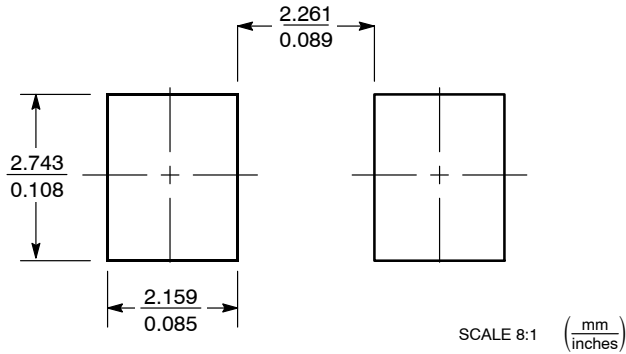

*For additional information on our Pb-Free strategy and soldering details, please download the ON Semiconductor Soldering and Mounting Techniques Reference Manual, SOLDERRM/D.

DOCUMENT NUMBER:	98ASB42669B	Electronic versions are uncontrolled except when accessed directly from the Document Repository. Printed versions are uncontrolled except when stamped "CONTROLLED COPY" in red.
DESCRIPTION:	SMB	PAGE 1 OF 1

ON Semiconductor and are trademarks of Semiconductor Components Industries, LLC dba ON Semiconductor or its subsidiaries in the United States and/or other countries. ON Semiconductor reserves the right to make changes without further notice to any products herein. ON Semiconductor makes no warranty, representation or guarantee regarding the suitability of its products for any particular purpose, nor does ON Semiconductor assume any liability arising out of the application or use of any product or circuit, and specifically disclaims any and all liability, including without limitation special, consequential or incidental damages. ON Semiconductor does not convey any license under its patent rights nor the rights of others.

MECHANICAL CASE OUTLINE

PACKAGE DIMENSIONS

ON Semiconductor®



SCALE 1:1

SMC 2-LEAD CASE 403AC ISSUE B

DATE 27 JUL 2017

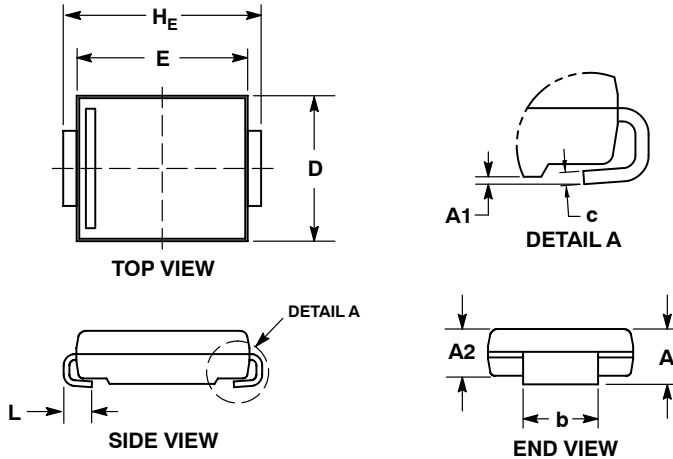

NOTES:

1. DIMENSIONING AND TOLERANCING PER ANME Y14.5M, 1994.
2. CONTROLLING DIMENSION: INCHES.
3. DIMENSIONS D AND E DO NOT INCLUDE MOLD FLASH. MOLD FLASH SHALL NOT EXCEED 0.254mm PER SIDE.
4. DIMENSIONS D AND E TO BE DETERMINED AT DATUM H.
5. DIMENSION b SHALL BE MEASURED WITHIN THE AREA DETERMINED BY DIMENSION L.

DIM	MILLIMETERS		INCHES	
	MIN	MAX	MIN	MAX
A	1.95	2.61	0.077	0.103
A1	0.05	0.20	0.002	0.008
A2	1.90	2.41	0.075	0.095
b	2.90	3.20	0.114	0.126
c	0.15	0.41	0.006	0.016
D	5.55	6.25	0.219	0.246
E	6.60	7.15	0.260	0.281
HE	7.75	8.15	0.305	0.321
L	0.75	1.60	0.030	0.063

GENERIC MARKING DIAGRAM*

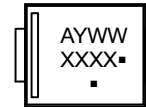

- XXXX = Specific Device Code
- A = Assembly Location
- Y = Year
- WW = Work Week
- = Pb-Free Package

(Note: Microdot may be in either location)

*This information is generic. Please refer to device data sheet for actual part marking. Pb-Free indicator, "G" or microdot "■", may or may not be present.

RECOMMENDED SOLDERING FOOTPRINT*

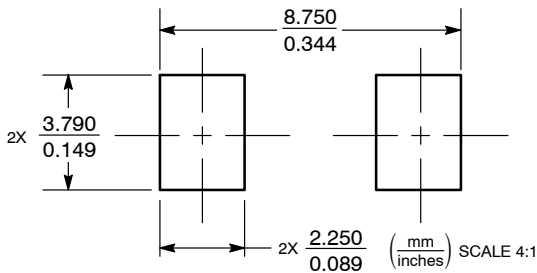

*For additional information on our Pb-Free strategy and soldering details, please download the ON Semiconductor Soldering and Mounting Techniques Reference Manual, SOLDERRM/D.

DOCUMENT NUMBER:	98AON97675F	Electronic versions are uncontrolled except when accessed directly from the Document Repository. Printed versions are uncontrolled except when stamped "CONTROLLED COPY" in red.
DESCRIPTION:	SMC 2-LEAD	PAGE 1 OF 1

ON Semiconductor and are trademarks of Semiconductor Components Industries, LLC dba ON Semiconductor or its subsidiaries in the United States and/or other countries. ON Semiconductor reserves the right to make changes without further notice to any products herein. ON Semiconductor makes no warranty, representation or guarantee regarding the suitability of its products for any particular purpose, nor does ON Semiconductor assume any liability arising out of the application or use of any product or circuit, and specifically disclaims any and all liability, including without limitation special, consequential or incidental damages. ON Semiconductor does not convey any license under its patent rights nor the rights of others.

ON Semiconductor and  are trademarks of Semiconductor Components Industries, LLC dba ON Semiconductor or its subsidiaries in the United States and/or other countries. ON Semiconductor owns the rights to a number of patents, trademarks, copyrights, trade secrets, and other intellectual property. A listing of ON Semiconductor's product/patent coverage may be accessed at www.onsemi.com/site/pdf/Patent-Marking.pdf. ON Semiconductor reserves the right to make changes without further notice to any products herein. ON Semiconductor makes no warranty, representation or guarantee regarding the suitability of its products for any particular purpose, nor does ON Semiconductor assume any liability arising out of the application or use of any product or circuit, and specifically disclaims any and all liability, including without limitation special, consequential or incidental damages. Buyer is responsible for its products and applications using ON Semiconductor products, including compliance with all laws, regulations and safety requirements or standards, regardless of any support or applications information provided by ON Semiconductor. "Typical" parameters which may be provided in ON Semiconductor data sheets and/or specifications can and do vary in different applications and actual performance may vary over time. All operating parameters, including "Typicals" must be validated for each customer application by customer's technical experts. ON Semiconductor does not convey any license under its patent rights nor the rights of others. ON Semiconductor products are not designed, intended, or authorized for use as a critical component in life support systems or any FDA Class 3 medical devices or medical devices with a same or similar classification in a foreign jurisdiction or any devices intended for implantation in the human body. Should Buyer purchase or use ON Semiconductor products for any such unintended or unauthorized application, Buyer shall indemnify and hold ON Semiconductor and its officers, employees, subsidiaries, affiliates, and distributors harmless against all claims, costs, damages, and expenses, and reasonable attorney fees arising out of, directly or indirectly, any claim of personal injury or death associated with such unintended or unauthorized use, even if such claim alleges that ON Semiconductor was negligent regarding the design or manufacture of the part. ON Semiconductor is an Equal Opportunity/Affirmative Action Employer. This literature is subject to all applicable copyright laws and is not for resale in any manner.

PUBLICATION ORDERING INFORMATION

LITERATURE FULFILLMENT:

Email Requests to: orderlit@onsemi.com

ON Semiconductor Website: www.onsemi.com

TECHNICAL SUPPORT

North American Technical Support:
Voice Mail: 1 800-282-9855 Toll Free USA/Canada
Phone: 011 421 33 790 2910

Europe, Middle East and Africa Technical Support:

Phone: 00421 33 790 2910

For additional information, please contact your local Sales Representative