



Is Now Part of



ON Semiconductor®

To learn more about ON Semiconductor, please visit our website at
www.onsemi.com

Please note: As part of the Fairchild Semiconductor integration, some of the Fairchild orderable part numbers will need to change in order to meet ON Semiconductor's system requirements. Since the ON Semiconductor product management systems do not have the ability to manage part nomenclature that utilizes an underscore (_), the underscore (_) in the Fairchild part numbers will be changed to a dash (-). This document may contain device numbers with an underscore (_). Please check the ON Semiconductor website to verify the updated device numbers. The most current and up-to-date ordering information can be found at www.onsemi.com. Please email any questions regarding the system integration to Fairchild_questions@onsemi.com.

ON Semiconductor and the ON Semiconductor logo are trademarks of Semiconductor Components Industries, LLC dba ON Semiconductor or its subsidiaries in the United States and/or other countries. ON Semiconductor owns the rights to a number of patents, trademarks, copyrights, trade secrets, and other intellectual property. A listing of ON Semiconductor's product/patent coverage may be accessed at www.onsemi.com/site/pdf/Patent-Marking.pdf. ON Semiconductor reserves the right to make changes without further notice to any products herein. ON Semiconductor makes no warranty, representation or guarantee regarding the suitability of its products for any particular purpose, nor does ON Semiconductor assume any liability arising out of the application or use of any product or circuit, and specifically disclaims any and all liability, including without limitation special, consequential or incidental damages. Buyer is responsible for its products and applications using ON Semiconductor products, including compliance with all laws, regulations and safety requirements or standards, regardless of any support or applications information provided by ON Semiconductor. "Typical" parameters which may be provided in ON Semiconductor data sheets and/or specifications can and do vary in different applications and actual performance may vary over time. All operating parameters, including "Typicals" must be validated for each customer application by customer's technical experts. ON Semiconductor does not convey any license under its patent rights nor the rights of others. ON Semiconductor products are not designed, intended, or authorized for use as a critical component in life support systems or any FDA Class 3 medical devices or medical devices with a same or similar classification in a foreign jurisdiction or any devices intended for implantation in the human body. Should Buyer purchase or use ON Semiconductor products for any such unintended or unauthorized application, Buyer shall indemnify and hold ON Semiconductor and its officers, employees, subsidiaries, affiliates, and distributors harmless against all claims, costs, damages, and expenses, and reasonable attorney fees arising out of, directly or indirectly, any claim of personal injury or death associated with such unintended or unauthorized use, even if such claim alleges that ON Semiconductor was negligent regarding the design or manufacture of the part. ON Semiconductor is an Equal Opportunity/Affirmative Action Employer. This literature is subject to all applicable copyright laws and is not for resale in any manner.

LM324/LM324A, LM2902/LM2902A

Quad Operational Amplifier

Features

- Internally Frequency Compensated for Unity Gain
- Large DC Voltage Gain: 100dB
- Wide Power Supply Range:
LM324/LM324A : 3V~32V (or $\pm 1.5 \sim 16V$)
LM2902/LM2902A: 3V~26V (or $\pm 1.5V \sim 13V$)
- Input Common Mode Voltage Range Includes Ground
- Large Output Voltage Swing: 0V to VCC -1.5V
- Power Drain Suitable for Battery Operation

Description

The LM324/LM324A, LM2902/LM2902A consist of four independent, high gain, internally frequency compensated operational amplifiers which were designed specifically to operate from a single power supply over a wide voltage range. operation from split power supplies is also possible so long as the difference between the two supplies is 3 volts to 32 volts. Application areas include transducer amplifier, DC gain blocks and all the conventional OP Amp circuits which now can be easily implemented in single power supply systems.

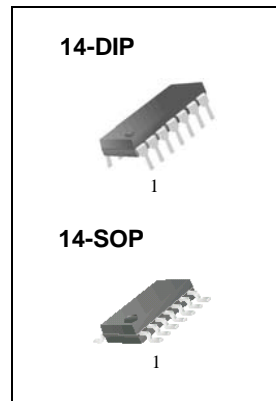

Internal Block Diagram

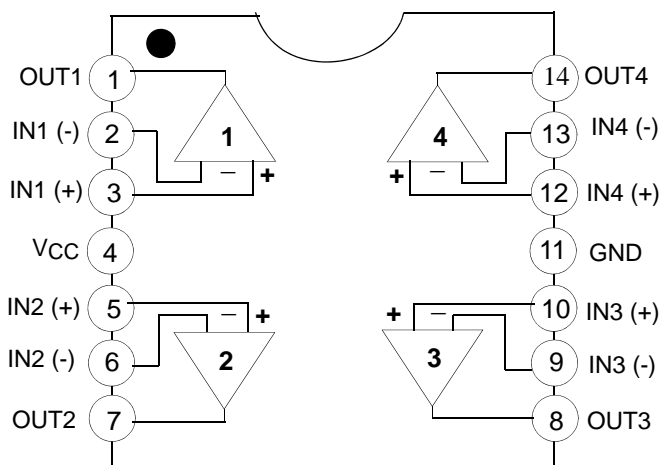

Schematic Diagram

(One Section Only)

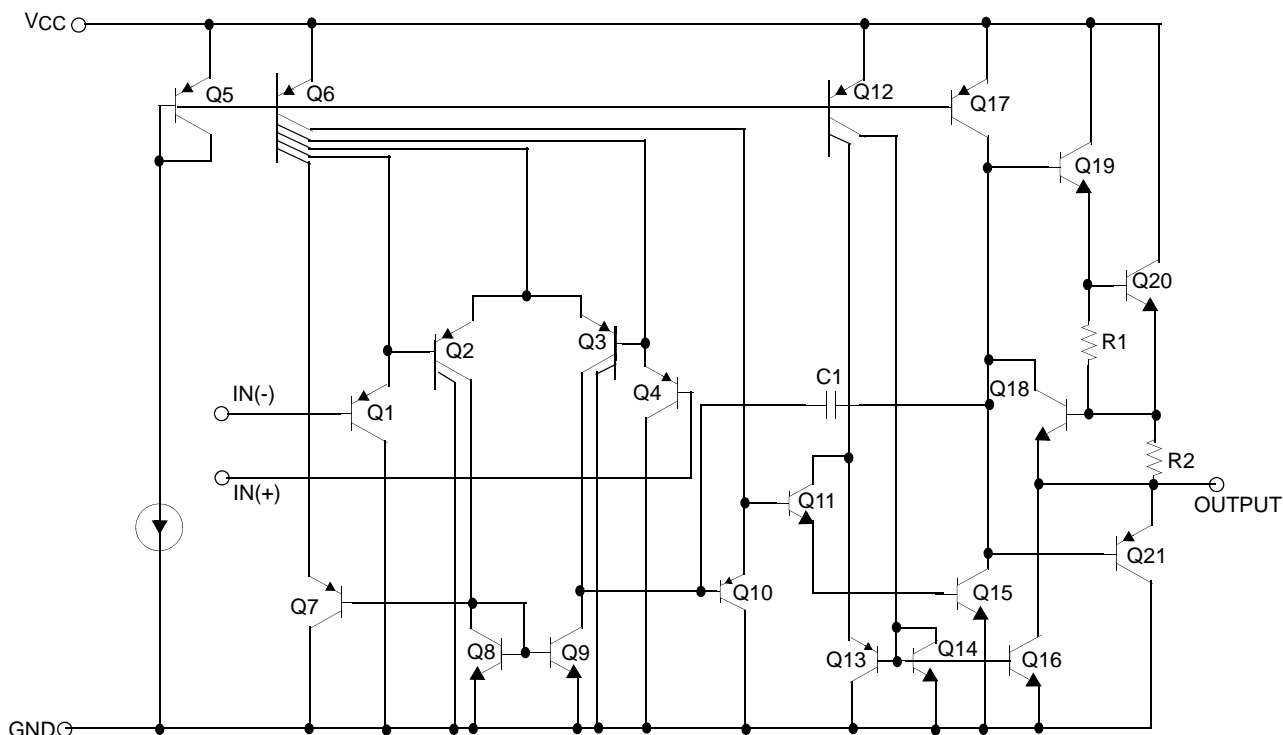

Absolute Maximum Ratings

Parameter	Symbol	LM324/LM324A	LM2902/LM2902A	Unit
Power Supply Voltage	V _{CC}	±16 or 32	±13 or 26	V
Differential Input Voltage	V _{I(DIFF)}	32	26	V
Input Voltage	V _I	-0.3 to +32	-0.3 to +26	V
Output Short Circuit to GND V _{CC} ≤ 15V, T _A = 25°C (one Amp)	-	Continuous	Continuous	-
Power Dissipation, T _A = 25°C 14-DIP 14-SOP	P _D	1310 640	1310 640	mW
Operating Temperature Range	T _{OPR}	0 ~ +70	-40 ~ +85	°C
Storage Temperature Range	T _{STG}	-65 ~ +150	-65 ~ +150	°C

Thermal Data

Parameter	Symbol	Value	Unit
Thermal Resistance Junction-Ambient Max. 14-DIP 14-SOP	R _{θja}	95 195	°C/W

Electrical Characteristics

($V_{CC} = 5.0V$, $V_{EE} = GND$, $T_A = 25^\circ C$, unless otherwise specified)

Parameter	Symbol	Conditions	LM324			LM2902			Unit	
			Min.	Typ.	Max.	Min.	Typ.	Max.		
Input Offset Voltage	V_{IO}	$V_{CM} = 0V$ to $V_{CC} - 1.5V$ $V_{O(P)} = 1.4V$, $R_S = 0\Omega$ (Note1)	-	1.5	7.0	-	1.5	7.0	mV	
Input Offset Current	I_{IO}	$V_{CM} = 0V$	-	3.0	50	-	3.0	50	nA	
Input Bias Current	I_{BIAS}	$V_{CM} = 0V$	-	40	250	-	40	250	nA	
Input Common-Mode Voltage Range	$V_{I(R)}$	Note1	0	-	$V_{CC} - 1.5$	0	-	$V_{CC} - 1.5$	V	
Supply Current	I_{CC}	$R_L = \infty$, $V_{CC} = 30V$ (LM2902, $V_{CC} = 26V$)	-	1.0	3	-	1.0	3	mA	
		$R_L = \infty$, $V_{CC} = 5V$	-	0.7	1.2	-	0.7	1.2	mA	
Large Signal Voltage Gain	G_V	$V_{CC} = 15V$, $R_L = 2k\Omega$ $V_{O(P)} = 1V$ to $11V$	25	100	-	25	100	-	V/mV	
Output Voltage Swing	$V_{O(H)}$	Note1	$R_L = 2k\Omega$	26	-	-	22	-	-	V
			$R_L = 10k\Omega$	27	28	-	23	24	-	V
	$V_{O(L)}$	$V_{CC} = 5V$, $R_L = 10k\Omega$	-	5	20	-	5	100	mV	
Common-Mode Rejection Ratio	CMRR	-	65	75	-	50	75	-	dB	
Power Supply Rejection Ratio	PSRR	-	65	100	-	50	100	-	dB	
Channel Separation	CS	$f = 1kHz$ to $20kHz$ (Note2)	-	120	-	-	120	-	dB	
Short Circuit to GND	ISC	$V_{CC} = 15V$	-	40	60	-	40	60	mA	
Output Current	ISOURCE	$V_{I(+)} = 1V$, $V_{I(-)} = 0V$ $V_{CC} = 15V$, $V_{O(P)} = 2V$	20	40	-	20	40	-	mA	
		$V_{I(+)} = 0V$, $V_{I(-)} = 1V$ $V_{CC} = 15V$, $V_{O(P)} = 2V$	10	13	-	10	13	-	mA	
	ISINK	$V_{I(+)} = 0V$, $V_{I(-)} = 1V$ $V_{CC} = 15V$, $V_{O(R)} = 200mV$	12	45	-	-	-	-	μA	
Differential Input Voltage	$V_{I(DIFF)}$	-	-	-	V_{CC}	-	-	V_{CC}	V	

Note :

- $V_{CC} = 30V$ for LM324, $V_{CC} = 26V$ for LM2902
- This parameter, although guaranteed, is not 100% tested in production.

Electrical Characteristics (Continued)

(VCC = 5.0V, VEE = GND, unless otherwise specified)

The following specification apply over the range of $0^{\circ}\text{C} \leq T_A \leq +70^{\circ}\text{C}$ for the LM324 ; and the $-40^{\circ}\text{C} \leq T_A \leq +85^{\circ}\text{C}$ for the LM2902

Parameter	Symbol	Conditions	LM324			LM2902			Unit	
			Min.	Typ.	Max.	Min.	Typ.	Max.		
Input Offset Voltage	V_{IO}	$V_{ICM} = 0V$ to $V_{CC} - 1.5V$ $V_{O(P)} = 1.4V$, $R_S = 0\Omega$ (Note1)	-	-	9.0	-	-	10.0	mV	
Input Offset Voltage Drift	$\Delta V_{IO}/\Delta T$	$R_S = 0\Omega$ (Note2)	-	7.0	-	-	7.0	-	$\mu\text{V}/^{\circ}\text{C}$	
Input Offset Current	I_{IO}	$V_{CM} = 0V$	-	-	150	-	-	200	nA	
Input Offset Current Drift	$\Delta I_{IO}/\Delta T$	$R_S = 0\Omega$ (Note2)	-	10	-	-	10	-	$\text{pA}/^{\circ}\text{C}$	
Input Bias Current	I_{BIAS}	$V_{CM} = 0V$	-	-	500	-	-	500	nA	
Input Common-Mode Voltage Range	$V_{I(R)}$	Note1	0	-	$V_{CC} - 2.0$	0	-	$V_{CC} - 2.0$	V	
Large Signal Voltage Gain	G_V	$V_{CC} = 15V$, $R_L = 2.0\text{k}\Omega$ $V_{O(P)} = 1V$ to $11V$	15	-	-	15	-	-	V/mV	
Output Voltage Swing	$V_{O(H)}$	Note1	$R_L = 2\text{k}\Omega$	26	-	-	22	-	-	V
			$R_L = 10\text{k}\Omega$	27	28	-	23	24	-	V
	$V_{O(L)}$	$V_{CC} = 5V$, $R_L = 10\text{k}\Omega$	-	5	20	-	5	100	mV	
Output Current	ISOURCE	$V_{I(+)} = 1V$, $V_{I(-)} = 0V$ $V_{CC} = 15V$, $V_{O(P)} = 2V$	10	20	-	10	20	-	mA	
	ISINK	$V_{I(+)} = 0V$, $V_{I(-)} = 1V$ $V_{CC} = 15V$, $V_{O(P)} = 2V$	5	8	-	5	8	-	mA	
Differential Input Voltage	$V_{I(DIFF)}$	-	-	-	V_{CC}	-	-	V_{CC}	V	

Note:

1. $V_{CC} = 30V$ for LM324 , $V_{CC} = 26V$ for LM2902
2. These parameters, although guaranteed, are not 100% tested in production.

Electrical Characteristics (Continued)

(VCC = 5.0V, VEE = GND, TA = 25°C, unless otherwise specified)

Parameter	Symbol	Conditions	LM324A			LM2902A			Unit	
			Min.	Typ.	Max.	Min.	Typ.	Max.		
Input Offset Voltage	V _{IO}	V _{CM} = 0V to V _{CC} -1.5V V _{O(P)} = 1.4V, R _S = 0Ω (Note1)	-	1.5	3.0	-	1.5	2.0	mV	
Input Offset Current	I _{IO}	V _{CM} = 0V	-	3.0	30	-	3.0	50	nA	
Input Bias Current	I _{BIAS}	V _{CM} = 0V	-	40	100	-	40	250	nA	
Input Common-Mode Voltage Range	V _{I(R)}	V _{CC} = 30V	0	-	V _{CC} -1.5	0	-	V _{CC} -1.5	V	
Supply Current	I _{CC}	V _{CC} = 30V, R _L = ∞ (LM2902, V _{CC} =26V)	-	1.5	3	-	1.0	3	mA	
		V _{CC} = 5V, R _L = ∞	-	0.7	1.2	-	0.7	1.2	mA	
Large Signal Voltage Gain	G _V	V _{CC} = 15V, R _L = 2kΩ V _{O(P)} = 1V to 11V	25	100	-	25	100	-	V/mV	
Output Voltage Swing	V _{O(H)}	Note1	R _L = 2kΩ	26	-	-	22	-	-	V
			R _L = 10kΩ	27	28	-	23	24	-	V
	V _{O(L)}	V _{CC} = 5V, R _L = 10kΩ	-	5	20	-	5	100	mV	
Common-Mode Rejection Ratio	CMRR	-	65	85	-	50	75	-	dB	
Power Supply Rejection Ratio	PSRR	-	65	100	-	50	100	-	dB	
Channel Separation	CS	f = 1kHz to 20kHz (Note2)	-	120	-	-	120	-	dB	
Short Circuit to GND	I _{SC}	V _{CC} = 15V	-	40	60	-	40	60	mA	
Output Current	I _{SOURCE}	V _{I(+)} = 1V, V _{I(-)} = 0V V _{CC} = 15V, V _{O(P)} = 2V	20	40	-	20	40	-	mA	
		V _{I(+)} = 0V, V _{I(-)} = 1V V _{CC} = 15V, V _{O(P)} = 2V	10	20	-	10	13	-	mA	
	I _{SINK}	V _{I(+)} = 0V, V _{I(-)} = 1V V _{CC} = 15V, V _{O(P)} = 200mV	12	50	-	-	-	-	μA	
Differential Input Voltage	V _{I(DIFF)}	-	-	-	V _{CC}	-	-	V _{CC}	V	

Note:

- V_{CC}=30V for LM324A ; V_{CC}=26V for LM2902A
- This parameter, although guaranteed, is not 100% tested in production.

Electrical Characteristics (Continued)(V_{CC} = 5.0V, V_{EE} = GND, unless otherwise specified)The following specification apply over the range of 0°C ≤ T_A ≤ +70°C for the LM324A ; and the -40°C ≤ T_A ≤ +85°C for the LM2902A

Parameter	Symbol	Conditions	LM324A			LM2902A			Unit	
			Min.	Typ.	Max.	Min.	Typ.	Max.		
Input Offset Voltage	V _{IO}	V _{CM} = 0V to V _{CC} -1.5V V _{O(P)} = 1.4V, R _S = 0Ω (Note1)	-	-	5.0	-	-	6.0	mV	
Input Offset Voltage Drift	ΔV _{IO} /ΔT	R _S = 0Ω (Note2)	-	7.0	30	-	7.0	-	μV/°C	
Input Offset Current	I _{IO}	V _{CM} = 0V	-	-	75	-	-	200	nA	
Input Offset Current Drift	ΔI _{IO} /ΔT	R _S = 0Ω (Note2)	-	10	300	-	10	-	pA/°C	
Input Bias Current	I _{BIAS}	-	-	40	200	-	-	500	nA	
Input Common-Mode Voltage Range	V _{I(R)}	Note1	0	-	V _{CC} -2.0	0	-	V _{CC} -2.0	V	
Large Signal Voltage Gain	G _V	V _{CC} = 15V, R _L = 2.0kΩ	15	-	-	15	-	-	V/mV	
Output Voltage Swing	V _{O(H)}	Note1	R _L = 2kΩ	26	-	-	22	-	-	V
			R _L = 10kΩ	27	28	-	23	24	-	V
	V _{O(L)}	V _{CC} = 5V, R _L = 10kΩ	-	5	20	-	5	100	mV	
Output Current	I _{SOURCE}	V _{I(+)} = 1V, V _{I(-)} = 0V V _{CC} = 15V, V _{O(P)} = 2V	10	20	-	10	20	-	mA	
	I _{SINK}	V _{I(+)} = 0V, V _{I(-)} = 1V V _{CC} = 15V, V _{O(P)} = 2V	5	8	-	5	8	-	mA	
Differential Input Voltage	V _{I(DIFF)}	-	-	-	V _{CC}	-	-	V _{CC}	V	

Note:1. V_{CC}=30V for LM324A ; V_{CC}=26V for LM2902A.

2. These parameters, although guaranteed, are not 100% tested in production.

Typical Performance Characteristics

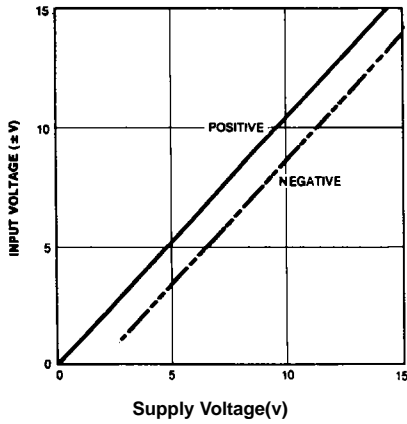

Figure 1. Input Voltage Range vs Supply Voltage

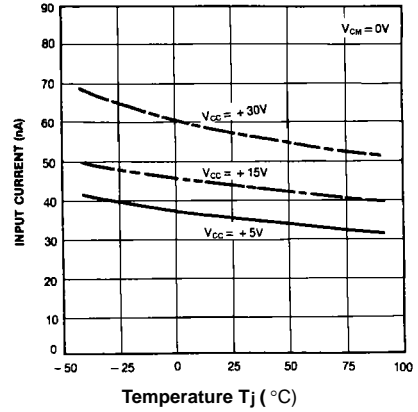

Figure 2. Input Current vs Temperature

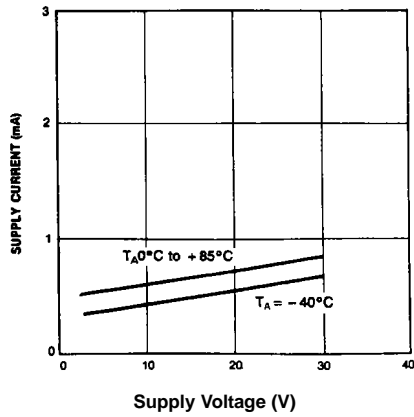

Figure 3. Supply Current vs Supply Voltage

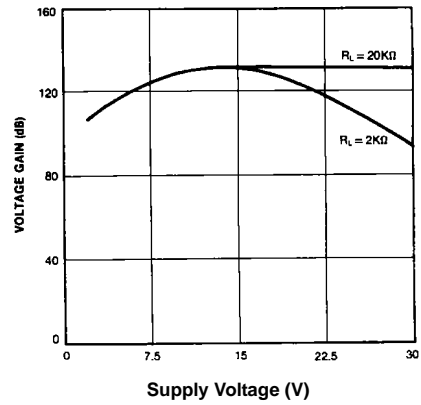

Figure 4. Voltage Gain vs Supply Voltage

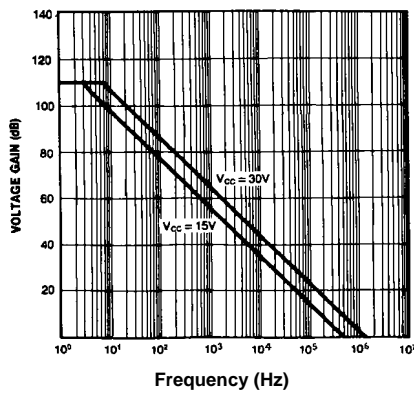

Figure 5. Open Loop Frequency Response

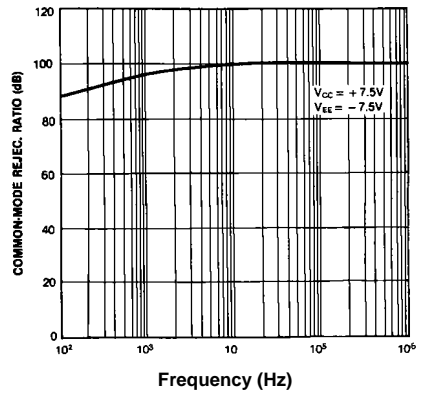

Figure 6. Common mode Rejection Ratio

Typical Performance Characteristics (Continued)

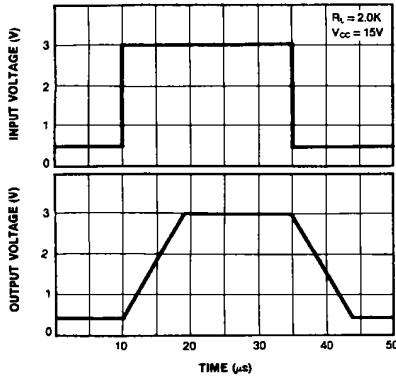

Figure 7. Voltage Follower Pulse Response

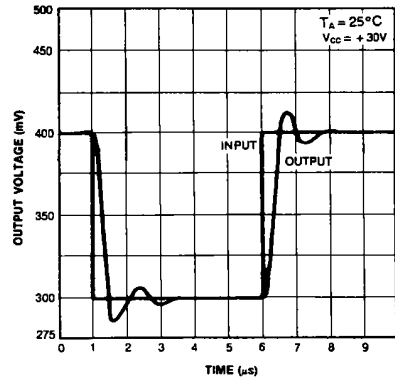

Figure 8. Voltage Follower Pulse Response (Small Signal)

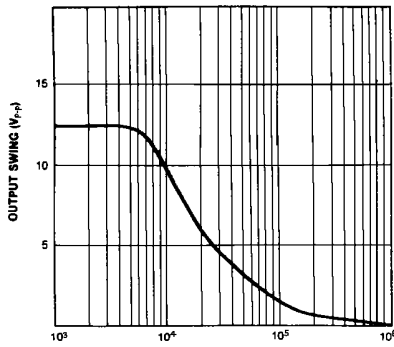

Figure 9. Large Signal Frequency Response

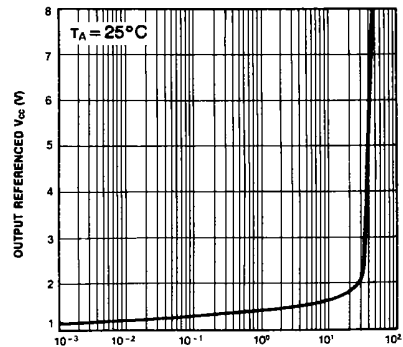

Figure 10. Output Characteristics vs Current Sourcing

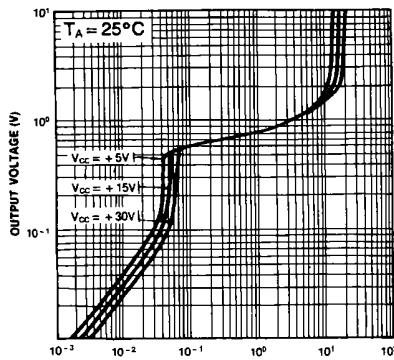

Figure 11. Output Characteristics vs Current Sinking

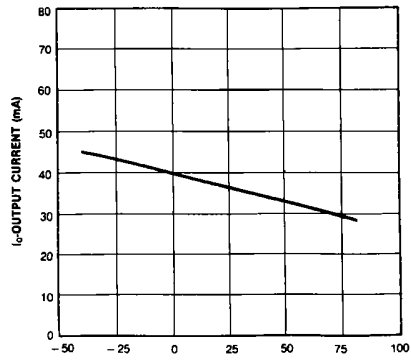

Figure 12. Current Limiting vs Temperature

Mechanical Dimensions

Package

Dimensions in millimeters

14-DIP

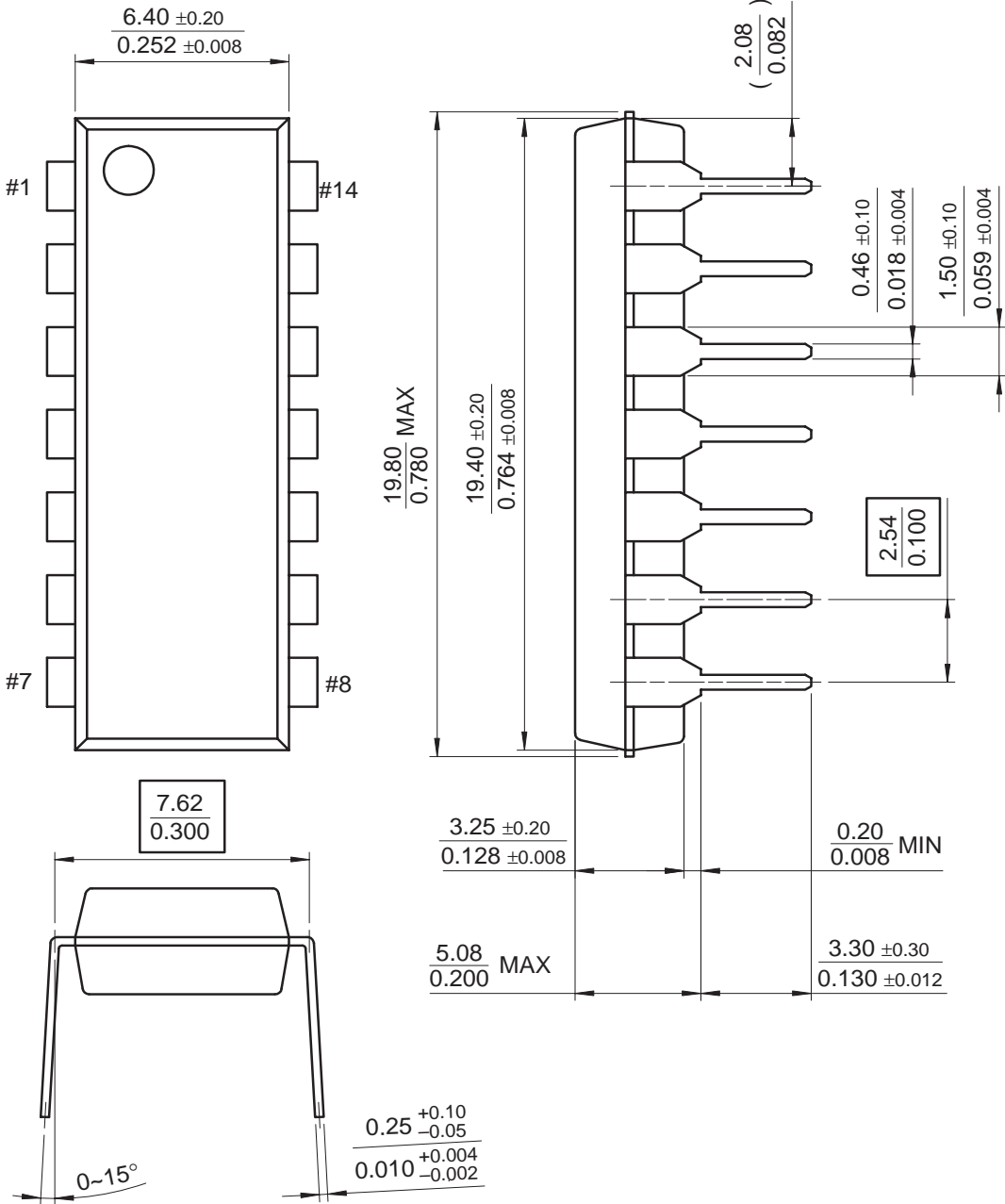

Ordering Information

Product Number	Package	Operating Temperature
LM324N	14-DIP	0 ~ +70°C
LM324AN		
LM324M	14-SOP	
LM324AM		
LM2902N	14-DIP	-40 ~ +85°C
LM2902M	14-SOP	
LM2902AM		

DISCLAIMER

FAIRCHILD SEMICONDUCTOR RESERVES THE RIGHT TO MAKE CHANGES WITHOUT FURTHER NOTICE TO ANY PRODUCTS HEREIN TO IMPROVE RELIABILITY, FUNCTION OR DESIGN. FAIRCHILD DOES NOT ASSUME ANY LIABILITY ARISING OUT OF THE APPLICATION OR USE OF ANY PRODUCT OR CIRCUIT DESCRIBED HEREIN; NEITHER DOES IT CONVEY ANY LICENSE UNDER ITS PATENT RIGHTS, NOR THE RIGHTS OF OTHERS.

LIFE SUPPORT POLICY

FAIRCHILD'S PRODUCTS ARE NOT AUTHORIZED FOR USE AS CRITICAL COMPONENTS IN LIFE SUPPORT DEVICES OR SYSTEMS WITHOUT THE EXPRESS WRITTEN APPROVAL OF THE PRESIDENT OF FAIRCHILD SEMICONDUCTOR CORPORATION. As used herein:

1. Life support devices or systems are devices or systems which, (a) are intended for surgical implant into the body, or (b) support or sustain life, and (c) whose failure to perform when properly used in accordance with instructions for use provided in the labeling, can be reasonably expected to result in a significant injury of the user.
2. A critical component in any component of a life support device or system whose failure to perform can be reasonably expected to cause the failure of the life support device or system, or to affect its safety or effectiveness.

ON Semiconductor and  are trademarks of Semiconductor Components Industries, LLC dba ON Semiconductor or its subsidiaries in the United States and/or other countries. ON Semiconductor owns the rights to a number of patents, trademarks, copyrights, trade secrets, and other intellectual property. A listing of ON Semiconductor's product/patent coverage may be accessed at www.onsemi.com/site/pdf/Patent-Marking.pdf. ON Semiconductor reserves the right to make changes without further notice to any products herein. ON Semiconductor makes no warranty, representation or guarantee regarding the suitability of its products for any particular purpose, nor does ON Semiconductor assume any liability arising out of the application or use of any product or circuit, and specifically disclaims any and all liability, including without limitation special, consequential or incidental damages. Buyer is responsible for its products and applications using ON Semiconductor products, including compliance with all laws, regulations and safety requirements or standards, regardless of any support or applications information provided by ON Semiconductor. "Typical" parameters which may be provided in ON Semiconductor data sheets and/or specifications can and do vary in different applications and actual performance may vary over time. All operating parameters, including "Typicals" must be validated for each customer application by customer's technical experts. ON Semiconductor does not convey any license under its patent rights nor the rights of others. ON Semiconductor products are not designed, intended, or authorized for use as a critical component in life support systems or any FDA Class 3 medical devices or medical devices with a same or similar classification in a foreign jurisdiction or any devices intended for implantation in the human body. Should Buyer purchase or use ON Semiconductor products for any such unintended or unauthorized application, Buyer shall indemnify and hold ON Semiconductor and its officers, employees, subsidiaries, affiliates, and distributors harmless against all claims, costs, damages, and expenses, and reasonable attorney fees arising out of, directly or indirectly, any claim of personal injury or death associated with such unintended or unauthorized use, even if such claim alleges that ON Semiconductor was negligent regarding the design or manufacture of the part. ON Semiconductor is an Equal Opportunity/Affirmative Action Employer. This literature is subject to all applicable copyright laws and is not for resale in any manner.

PUBLICATION ORDERING INFORMATION

LITERATURE FULFILLMENT:

Literature Distribution Center for ON Semiconductor
19521 E. 32nd Pkwy, Aurora, Colorado 80011 USA
Phone: 303-675-2175 or 800-344-3860 Toll Free USA/Canada
Fax: 303-675-2176 or 800-344-3867 Toll Free USA/Canada
Email: orderlit@onsemi.com

N. American Technical Support: 800-282-9855 Toll Free
USA/Canada
Europe, Middle East and Africa Technical Support:
Phone: 421 33 790 2910
Japan Customer Focus Center
Phone: 81-3-5817-1050

ON Semiconductor Website: www.onsemi.com
Order Literature: <http://www.onsemi.com/orderlit>
For additional information, please contact your local
Sales Representative