

Molded IR Receiver Packaging Options

Vishay Semiconductors



IR Receiver Modules for Remote Control Systems

Vishay offers stock molded IR receivers in four different packages:
loose packed in tubes, mounted on tape for reel or ammpack, or packed bulk in plastic bags.

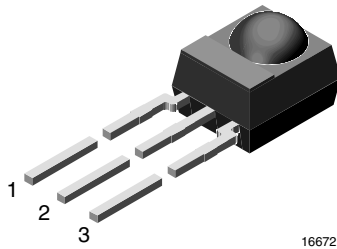

FEATURES

- Compliant with RoHS 2002/95/EC and WEEE 2002/96/EC



AVAILABLE FOR:

- TSOP348..
- TSOP344..
- TSOP343..
- TSOP341..
- TSOP44...
- TSOP48...
- TSOP41...
- TSOP324..
- TSOP323..
- TSOP322..
- TSOP321..
- TSOP24...
- TSOP22...
- TSOP21...



Datasheet.Directory

LOOSE PACKED IN TUBE

ORDERING INFORMATION

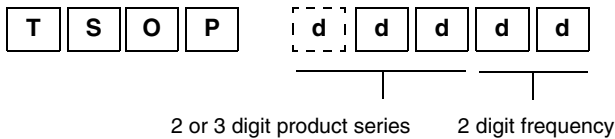

Note

d = "digit", please consult the list of available devices create a valid part number.

Example: TSOP4838

PACKING QUANTITY

- 90 pieces per tube
- 24 tubes per carton

PACKAGING DIMENSIONS in millimeters

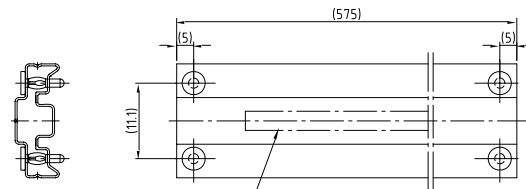
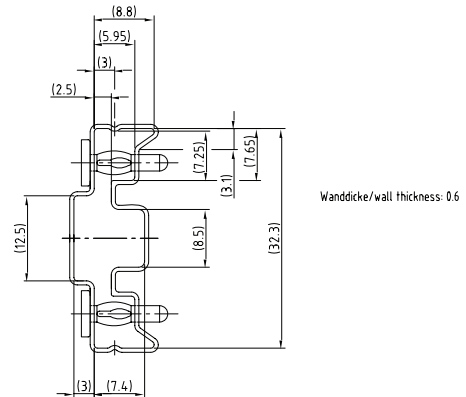

1:1

Druck / Printing for tubes
1400-5548.0-3 Version 1

Drawing-No.: 9.700-5185.0-4
Rev. 13; Date: 20.11.03
20273-1



Molded IR Receiver Packaging Options

IR Receiver Modules for
Remote Control Systems

Vishay Semiconductors

TAPE AND REEL/AMMOPACK

Up to 3 consecutive components may be missing if the gap is followed by at least 6 components. A maximum of 0.5 % of the components per reel quantity may be missing. At least 5 empty positions are present at the start and the end of the tape to enable insertion.

Tensile strength of the tape: > 15 N

Pulling force in the plane of the tape, at right angles to the reel: > 5 N

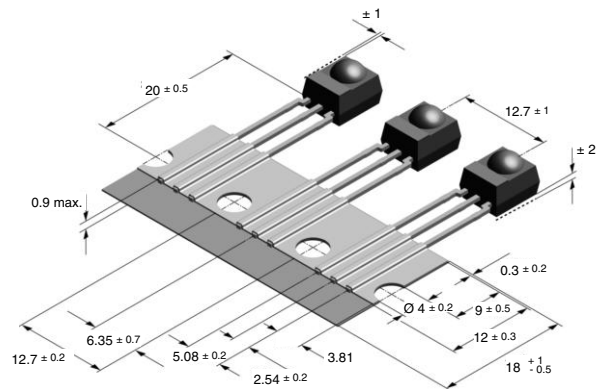
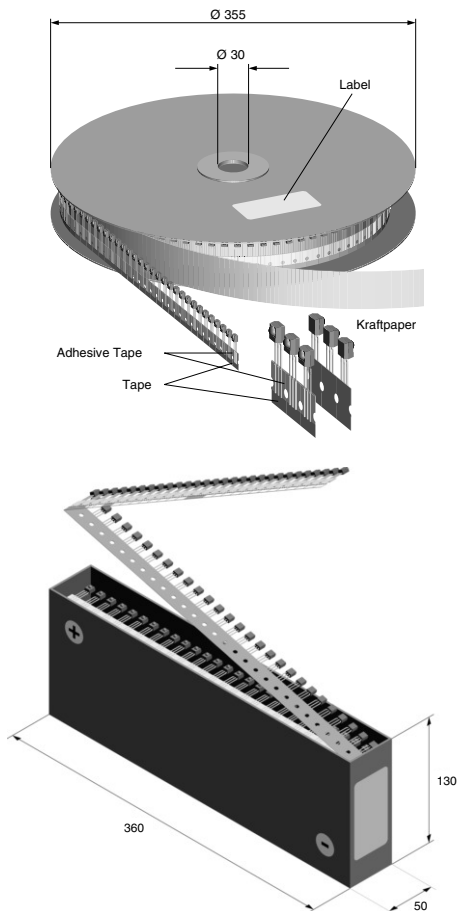

ORDERING INFORMATION

T S O P

d d d d d

S S 1

B S d d

Z

2 or 3 digit product series

2 digit frequency

SS1 for tape and reel,
bulk or ammopack

Tape and reel
dd = 12 or 21

Ammopack

Note

d = "digit", please consult the list of available devices create a valid part number.

Example: TSOP4838SS1BS12
TSOP2238SS1BS12Z

PACKING QUANTITY

- 1000 pieces per reel
- 1000 pieces per ammopack

Molded IR Receiver Packaging Options

Vishay Semiconductors

IR Receiver Modules for
Remote Control Systems



BULK PACKAGING

The option "BK" signifies bulk packaging in conductive plastic bags. A maximum of 0.3 % of the components per box may be missing.

ORDERING INFORMATION

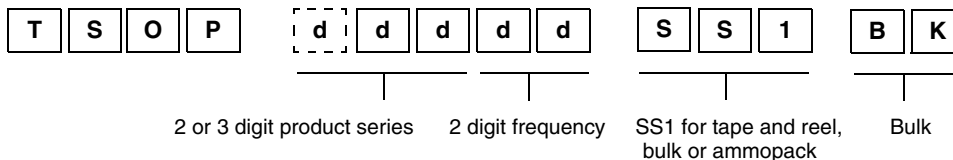

Note

d = "digit", please consult the list of available devices create a valid part number.

EXAMPLE: TSOP4838SS1BK
TSOP2238SS1BK

PACKING QUANTITY

- 250 pieces per bag (each bag is individually boxed)
- 6 bags per carton