

### CAL-CHIP LEADLESS INDUCTORS

NL322522, NL453232, series for signal circuit applications

These revolutionary, high reliability winding type leadless (wound chip) inductors for automatic mounting have been developed in response to the trend toward higher density mounting of parts in electronic circuits. Since metal terminals are used as the electrodes and the body is molded of heat resistant resin, these inductors offer many superior features.

#### Features

- Leaching resistant terminations due to metal tab electrodes.
- Coils encapsulated in heat-proof resin make high accurate dimensions and resistant to mechanical shock or pressure.
- High resistance to heat and humidity.
- Matched parts on taping-reel.

#### Applications

Microtelevisions, liquid crystal televisions, video cameras, portable VCRs, car radios, car stereos, thin type radios, television tuners, mobile telephones, radio equipment and modules such as hybrid ICs.

#### Inductance Range

Type	Inductance ( $\mu\text{H}$ )	Size
NL322522T	.22 to 220	1210
NL453232T	1.00 to 1000	1812

The number from among sequence of number  $E_{12}$  shown in table below multiplied by  $10^n$  ( $n$  is a positive integer) shall be used.

$E_{12}$  1 1.2 1.5 1.8 2.2 2.7 3.3 3.9 4.7 5.6 6.8 8.2

*Remark: The sequence of number  $E_{12}$  is a geometrical progression attained by using the numerical value (1.2) which is attained by discarding fraction of  $^{12}\sqrt{10}$  as common ratio, and its number are rounded into two figures.*

#### Standard Specifications

Temperature rise	20°C [68°F] max.
Ambient temperature	80°C [176°F]
Storage temperature	-40 to +100°C [-40 to +212°F]
Operating temperature	-20 to +100°C [-4 to +212°F]
Terminal tensile strength	1 kg min. (0.5 kg for the NL322522)
Current rating	Value obtained when current flows and the temperature has risen to 20°C [60°F] or when LC current flows and the initial value of inductance has fallen by 10%, whichever is smaller.
Resistance to soldering heat	260°C [500°F], 10 seconds
Resistance to solvent	Conforms to MIL-STD-202E

#### Product Identification

- Non-magnetic shield type

$\frac{\text{NL}}{(1)} \frac{32}{(2)} \frac{25}{(3)} \frac{22}{(4)} \frac{\text{T}}{(5)} - \frac{\text{OOO}}{(6)} \frac{\square}{(7)}$

- Non-magnetic shield type

$\frac{\text{NL}}{(1)} \frac{45}{(2)} \frac{32}{(3)} \frac{32}{(4)} \frac{\text{T}}{(5)} - \frac{\text{OOO}}{(6)} \frac{\square}{(7)}$

### CAL-CHIP LEADLESS INDUCTORS [Non-magnetic shield]

NL322522 series for signal circuit applications

#### SHAPES AND DIMENSIONS

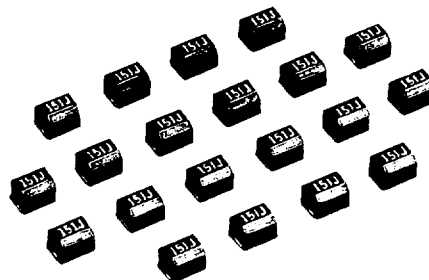
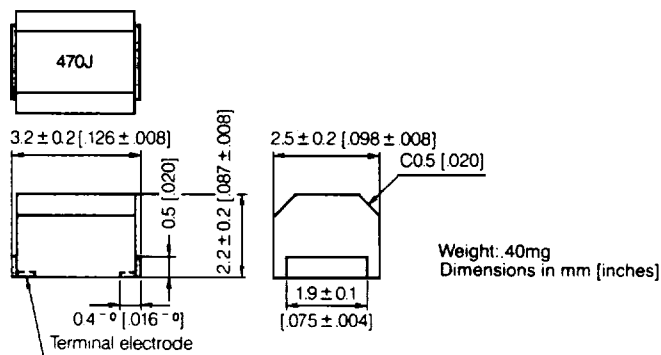

#### ELECTRICAL CHARACTERISTICS

Part No.	Inductance	Q min.	L, Q test frequency (MHz)	SRF (MHz)min.	Rdc (Ω) max.	Idc (mA)max.
NL322522T-R22M	0.22±20%	30	25.2	350	0.32	450
NL322522T-R27M	0.27±20%	30	25.2	320	0.36	450
NL322522T-R33M	0.33±20%	30	25.2	300	0.40	450
NL322522T-R39M	0.39±20%	30	25.2	250	0.45	450
NL322522T-R47M	0.47±20%	30	25.2	220	0.50	450
NL322522T-R56M	0.56±20%	30	25.2	180	0.55	450
NL322522T-R68M	0.68±20%	30	25.2	160	0.60	450
NL322522T-R82M	0.82±20%	30	25.2	140	0.65	450
NL322522T-1R0K	1.0±10%	30	7.96	120	0.70	400
NL322522T-1R2K	1.2±10%	30	7.96	100	0.75	390
NL322522T-1R5K	1.5±10%	30	7.96	85	0.85	370
NL322522T-1R8K	1.8±10%	30	7.96	80	0.90	350
NL322522T-2R2K	2.2±10%	30	7.96	75	1.0	320
NL322522T-2R7K	2.7±10%	30	7.96	70	1.1	290
NL322522T-3R3K	3.3±10%	30	7.96	60	1.2	260
NL322522T-3R9K	3.9±10%	30	7.96	55	1.3	250
NL322522T-4R7K	4.7±10%	30	7.96	50	1.5	220
NL322522T-5R6K	5.6±10%	30	7.96	47	1.6	200
NL322522T-6R8K	6.8±10%	30	7.96	43	1.8	180
NL322522T-8R2K	8.2±10%	30	7.96	40	2.0	170
NL322522T-100K	10±10%	30	2.52	36	2.1	150
NL322522T-120K	12±10%	30	2.52	33	2.5	140
NL322522T-150K	15±10%	30	2.52	30	2.8	130
NL322522T-180K	18±10%	30	2.52	27	3.3	120
NL322522T-220K	22±10%	30	2.52	25	3.7	110
NL322522T-270K	27±10%	30	2.52	20	5.0	80
NL322522T-330K	33±10%	30	2.52	17	5.6	70
NL322522T-390K	39±10%	30	2.52	16	6.4	65
NL322522T-470K	47±10%	30	2.52	15	7.0	60
NL322522T-560K	56±10%	30	2.52	13	8.0	55
NL322522T-680K	68±10%	30	2.52	12	9.0	50

\*Inductance tolerance ±10%  Standard ±5%  Special order.

### CAL-CHIP LEADLESS INDUCTORS [Non-magnetic shield]

NL322522 series for signal circuit applications

#### NL322522T

Part No.	Inductance	Q min.	L, Q test frequency (MHz)	SRF (MHz)min.	Rdc ( $\Omega$ ) max.	Idc (mA)max.
NL322522T-820K	82 $\pm$ 10%	30	2.52	11	10.0	45
NL322522T-101K	100 $\pm$ 10%	20	0.796	10	10.0	40
NL322522T-121K	120 $\pm$ 10%	20	0.796	10	11.0	70
NL322522T-151K	150 $\pm$ 10%	20	0.796	8	15.0	65
NL322522T-181K	180 $\pm$ 10%	20	0.796	7	17.0	60
NL322522T-221K	220 $\pm$ 10%	20	0.796	7	21.0	50

Inductance change vs. frequency characteristics

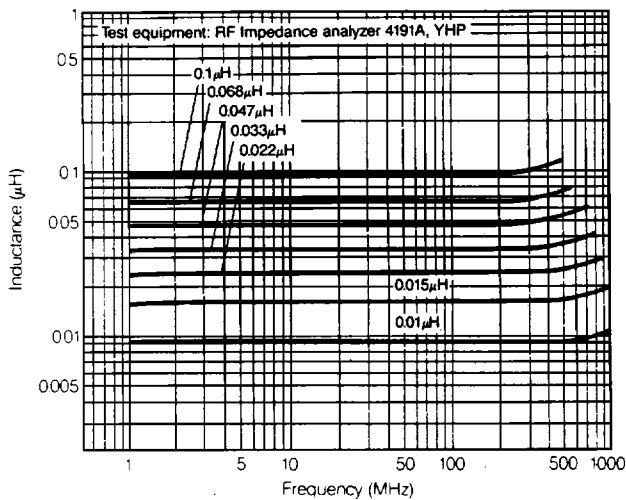

Q vs. frequency characteristics

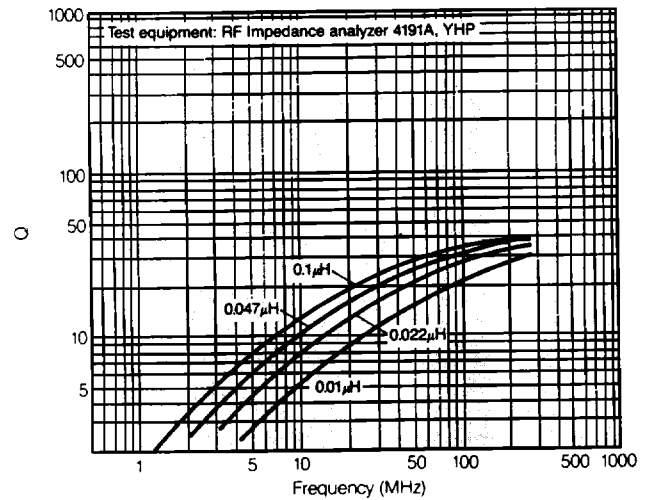

Impedance change vs. frequency characteristics

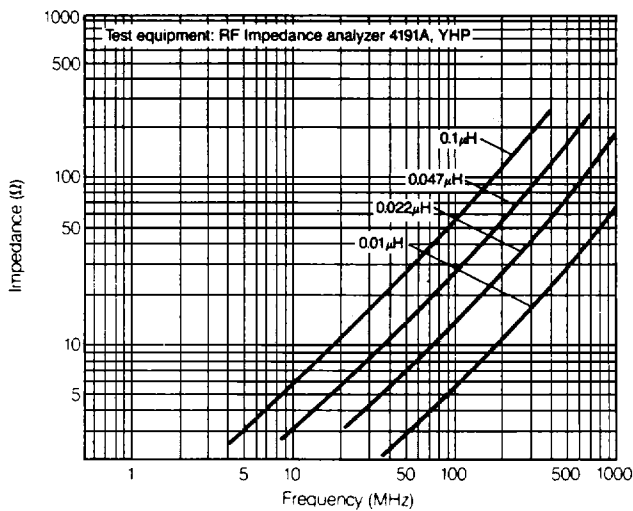

### CAL-CHIP LEADLESS INDUCTORS [Non-magnetic shield]

NL322522 series for signal circuit applications

Inductance change vs. DC superposition characteristics

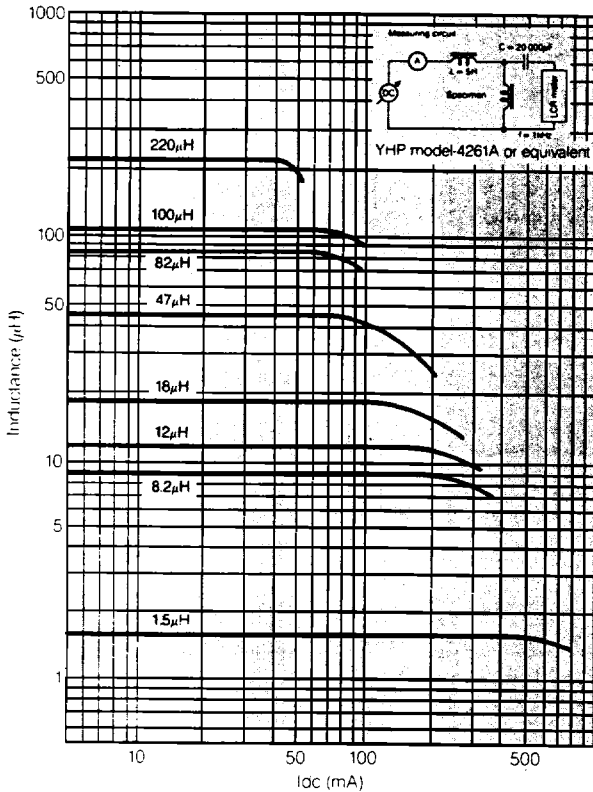

Impedance change vs. frequency characteristics

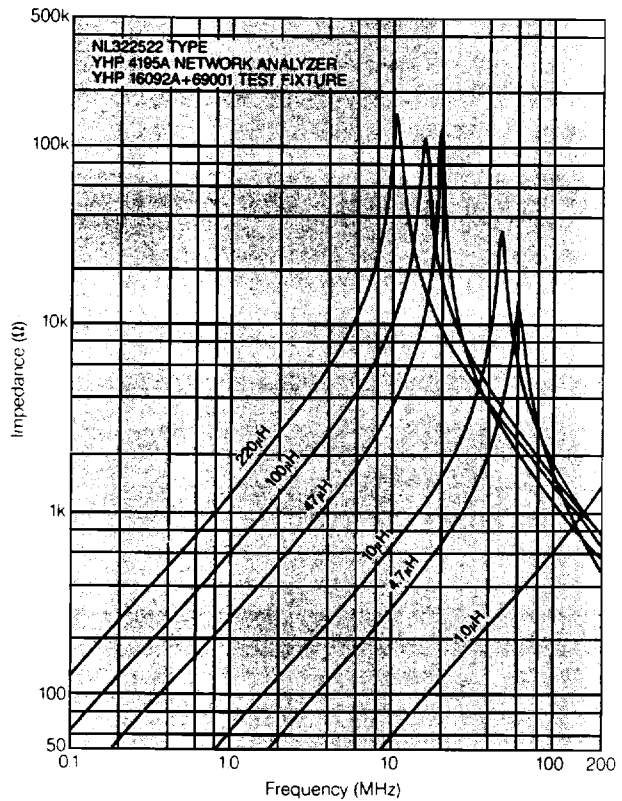

Inductance change vs. temperature characteristics

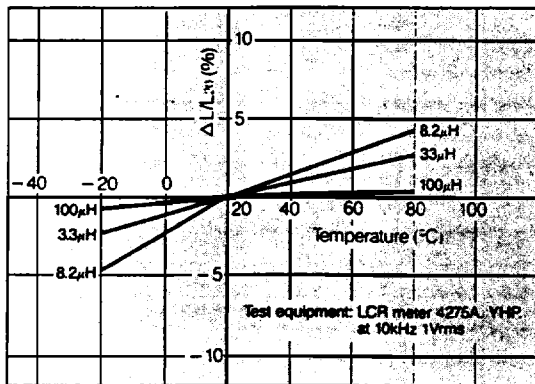

Inductance change vs. frequency characteristics

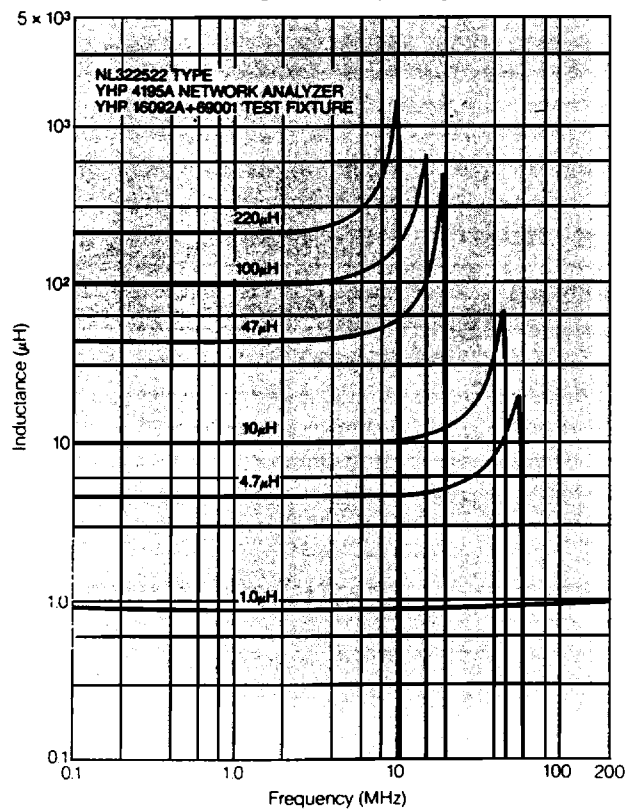

Q vs. frequency characteristics

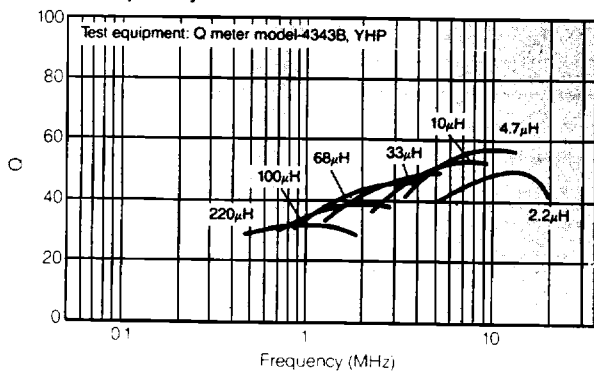

### CAL-CHIP LEADLESS INDUCTORS [Non-magnetic shield]

NL453232 series for signal circuit applications

WOUND CHIP INDUCTOR  
NL453232 SERIES  
SHAPE AND DIMENSIONS

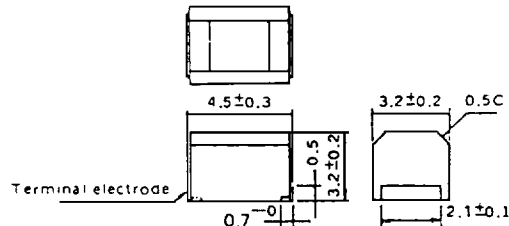
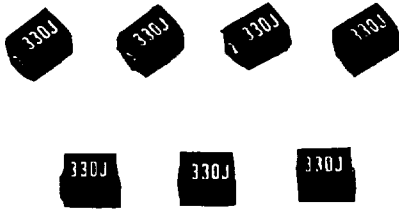

(Unit: mm)

### ELECTRICAL CHARACTERISTICS

Part No.	L	TOL.	Q	TEST FREQ. (MHz)	SFR	Ohms	IDC (mA)
	( $\mu$ H)	$\pm\%$	Min.		(MHz) Min.	Max.	
NL453232-1R0K	1.0	10	50	7.96	100	0.50	600
NL453232-1R2K	1.2	10	50	7.96	80	0.55	550
NL453232-1R5K	1.5	10	50	7.96	70	0.60	500
NL453232-1R8K	1.8	10	50	7.96	60	0.65	490
NL453232-2R2K	2.2	10	50	7.96	55	0.70	480
NL453232-2R7K	2.7	10	50	7.96	50	0.75	470
NL453232-3R3K	3.3	10	50	7.96	45	0.80	460
NL453232-3R9K	3.9	10	50	7.96	40	0.90	450
NL453232-4R7K	4.7	10	50	7.96	35	1.00	440
NL453232-5R6K	5.6	10	50	7.96	33	1.10	430
NL453232-6R8K	6.8	10	50	7.96	27	1.20	420
NL453232-8R2K	8.2	10	50	7.96	25	1.40	410
NL453232-100K	10	10	50	2.52	20	1.60	380
NL453232-120K	12	10	50	2.52	18	2.00	350
NL453232-150K	15	10	50	2.52	17	2.50	320
NL453232-180K	18	10	50	2.52	15	2.80	290
NL453232-220K	22	10	50	2.52	13	3.20	260
NL453232-270K	27	10	50	2.52	12	3.60	230
NL453232-330K	33	10	50	2.52	11	4.00	200
NL453232-390K	39	10	50	2.52	10	4.50	180
NL453232-470K	47	10	50	2.52	10	5.00	160
NL453232-560K	56	10	50	2.52	9.0	5.50	140
NL453232-680K	68	10	50	2.52	9.0	6.00	130
NL453232-820K	82	10	50	2.52	8.0	7.50	120
NL453232-101K	100	10	40	0.796	8.0	8.00	110
NL453232-121K	120	10	40	0.796	6.0	8.00	110
NL453232-151K	150	10	40	0.796	5.0	9.50	105
NL453232-181K	180	10	40	0.796	5.0	9.50	102
NL453232-221K	220	10	40	0.796	4.0	10.0	100
NL453232-271K	270	10	40	0.796	4.0	12.0	92
NL453232-331K	330	10	40	0.796	3.5	14.0	85
NL453232-391K	390	10	40	0.796	3.0	16.0	80
NL453232-471K	470	10	40	0.796	3.0	26.0	62
NL453232-561K	560	10	30	0.796	3.0	30.0	50
NL453232-681K	680	10	30	0.796	3.0	30.0	50
NL453232-821K	820	10	30	0.796	2.5	35.0	30
NL453232-102K	1000	10	30	0.252	2.5	40.0	30

### CAL-CHIP LEADLESS INDUCTORS [Non-magnetic shield]

NL453232 series for signal circuit applications

Inductance change vs. DC superposition characteristics

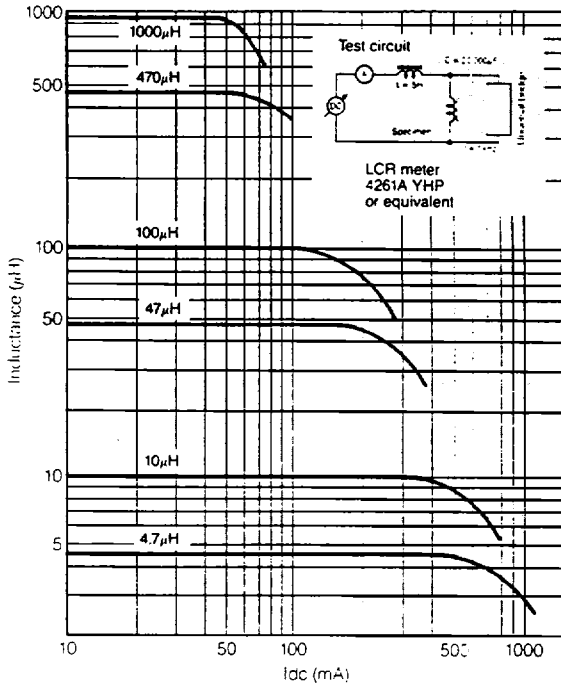

Impedance change vs. frequency characteristics

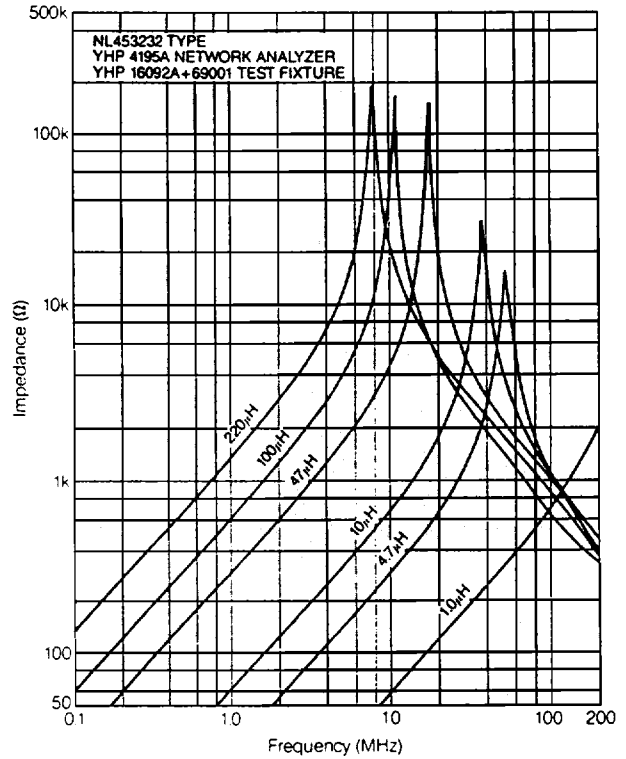

Inductance change vs. temperature characteristics

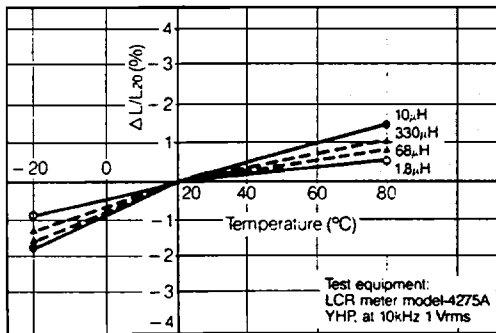

Inductance change vs. frequency characteristics

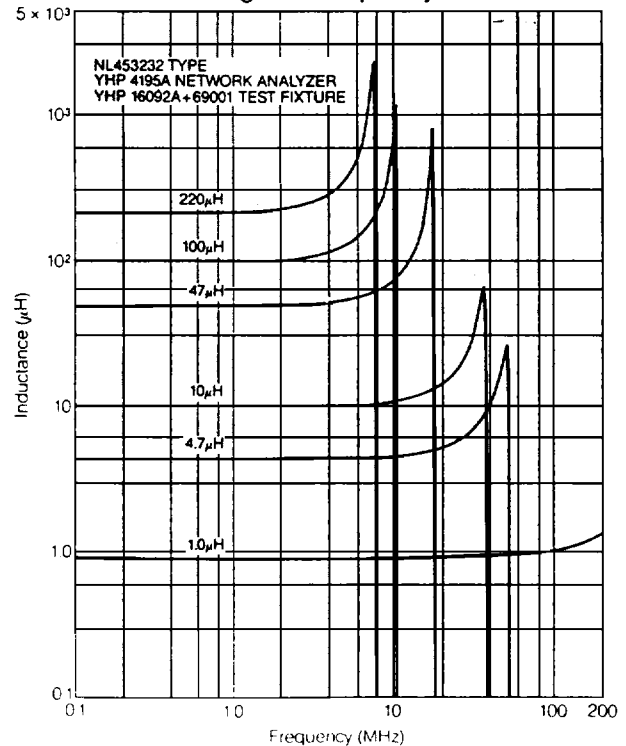

Q vs. frequency characteristics

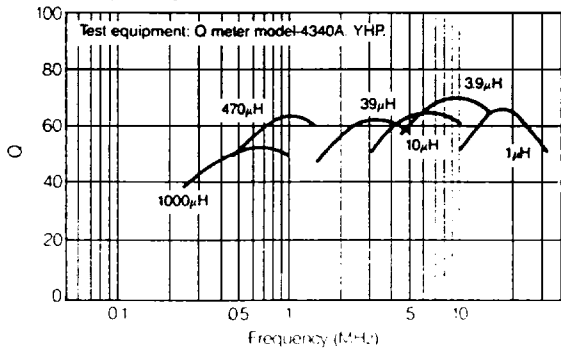

### CAL-CHIP LEADLESS INDUCTORS

NL322522, NL453232, series for signal circuit applications

#### PACKAGING

Number of packages

Type	NL322522T	NL453232T
Pcs./reel	2,000	500

#### TAPE DIMENSIONS (EIA-481)

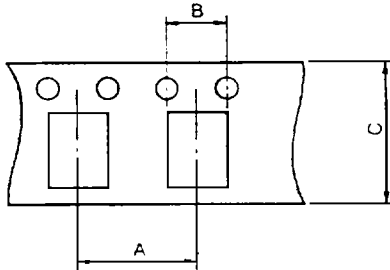

Dimensions in mm [inches]

Type	A	B	C
NL322522T	4 [.157]	4 [.157]	8 [.315]
NL453232T	8 [.315]	4 [.157]	12 [.472]

The storage temperature for packaging is 0 to 60°C [32 to 140°F].

#### PC BOARD PATTERN

(1) Parallel (2) Series

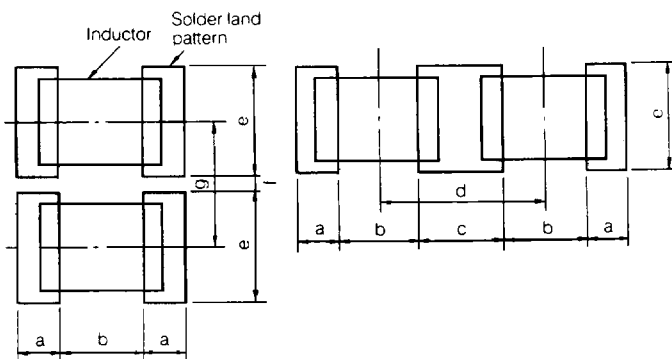

Dimensions in mm [inches]

Type	a	b	c	d	e	f	g
NL322522	1 [.039]	2 [.079]	3 [.118]	5 [.197]	3 [.118]	0.5 [.020]	3.5 [.138]
NL453232	1.5 [.059]	3 [.118]	3 [.118]	6 [.236]	4 [.157]	0.6 [.024]	4.6 [.181]

#### REEL DIMENSIONS

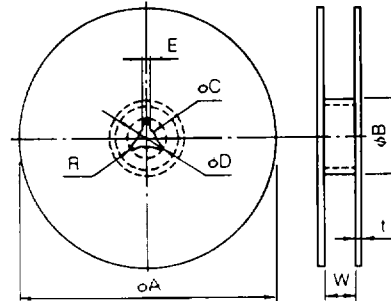

Dimensions in mm [inches]

A: 178±2.0 [7.008±.079]	E: 2.0±0.5 [.079±.020]
B: 50 min. [1.969]	R: R1.0 [.039]
C: 13.0±0.5 [.512±.020]	W: 14.0*±1.5 [.551±.059]
D: 2.0±0.5 [.079±.020]	t: 2.0±0.5 [.079±.030]

\*NL322522T: 10.0mm [.394 inches]

#### TAPING AND DRAWING DIRECTION

Embossed Tape

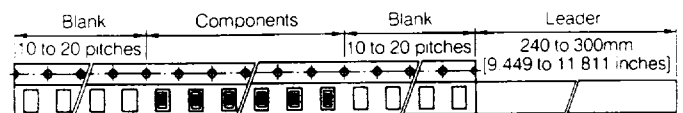
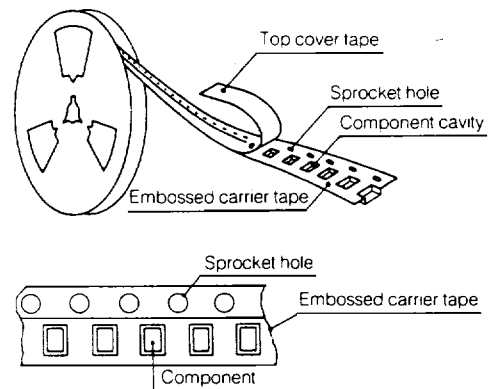

Drawing direction →