

EVALUATION KIT MANUAL  
FOLLOWS DATA SHEET

# MAXIM

## Adjustable, High-Linearity, SiGe Dual-Band LNA/Mixer ICs

MAX2320/21/22/24/26/27

### General Description

The MAX2320/MAX2321/MAX2322/MAX2324/MAX2326/MAX2327 high-performance silicon germanium (SiGe) receiver front-end ICs set a new industry standard for low noise and high linearity at a low supply current. This family integrates a variety of unique features such as an LO frequency doubler and divider, dual low-noise amplifier (LNA) gain settings, and a low-current paging mode that extends the handset standby time.

The MAX2320 family includes six ICs: four operate at both cellular and PCS frequencies, one operates at cellular frequencies, and one at PCS frequencies (see *Selector Guide*). Each part includes an LNA with a high input third-order intercept point (IIP3) to minimize intermodulation and cross-modulation in the presence of large interfering signals. In low-gain mode, the LNA is bypassed to provide higher cascaded IIP3 at a lower current. For paging, a low-current, high-gain mode is provided.

The CDMA mixers in cellular and PCS bands have high linearity, low noise, and differential IF outputs. The FM mixer is designed for lower current and a single-ended output.

All devices come in a 20-pin TSSOP-EP package with exposed paddle (EP) and are specified for the extended temperature range (-40°C to +85°C).

### Applications

CDMA/TDMA/PDC/WCDMA/GSM Cellular Phones  
Single/Dual/Triple-Mode Phones  
Wireless Local Loop (WLL)

### Selector Guide

PART	DESCRIPTION
MAX2320	Dual-band, dual VCO inputs, and dual IF outputs
MAX2321	MAX2320 with LO doubler
MAX2322	PCS band, single mode with optional frequency doubler
MAX2324	Cellular band, dual IF outputs
MAX2326	MAX2320 with LO divider
MAX2327	Dual-band, dual VCO inputs, and separately controlled VCO buffers

Typical Application Circuits appear at end of data sheet.

### Features

- ◆ Ultra-High Linearity at Ultra-Low Current and Noise
- ◆ +2.7V to +3.6V Operation
- ◆ Pin-Selectable Low-Gain Mode Reduces Gain by 17dB and Current by 3mA
- ◆ Pin-Selectable Paging Mode Reduces Current Draw by 6mA when Transmitter Is Not in Use
- ◆ LO Output Buffers
- ◆ LO Frequency Doubler (MAX2321)
- ◆ LO Frequency Divider (MAX2326)
- ◆ 0.1µA Shutdown Current
- ◆ 20-Pin TSSOP-EP Package

### Ordering Information

PART	TEMP RANGE	PIN-PACKAGE
MAX2320EUP	-40°C to +85°C	20 TSSOP-EP*
MAX2320EUP+	-40°C to +85°C	20 TSSOP-EP*
MAX2321EUP	-40°C to +85°C	20 TSSOP-EP*
MAX2321EUP+	-40°C to +85°C	20 TSSOP-EP*

+Indicates lead-free package.

\*EP = Exposed pad.

Ordering Information continued at end of data sheet.

### Pin Configurations

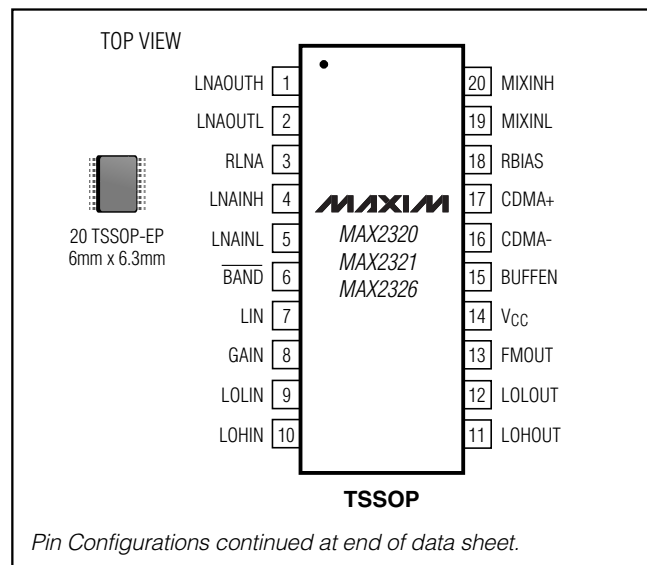

MAXIM

Maxim Integrated Products 1

For pricing delivery, and ordering information please contact Maxim/Dallas Direct! at 1-888-629-4642, or visit Maxim's website at [www.maxim-ic.com](http://www.maxim-ic.com).

# Adjustable, High-Linearity, SiGe Dual-Band LNA/Mixer ICs

## ABSOLUTE MAXIMUM RATINGS

V <sub>CC</sub> to GND .....	-0.3V to +4.3V	Junction Temperature .....	+150°C
Digital Input Voltage to GND .....	-0.3V to (V <sub>CC</sub> + 0.3V)	Storage Temperature Range .....	-65°C to +150°C
RF Input Signals .....	1.0V peak	Lead Temperature (soldering, 10s) .....	+300°C
Continuous Power Dissipation (T <sub>A</sub> = +70°C)			
20-Pin TSSOP-EP (derate 80mW/°C above +70°C) .....	6.4W		
Operating Temperature Range .....	-40°C to +85°C		

Stresses beyond those listed under "Absolute Maximum Ratings" may cause permanent damage to the device. These are stress ratings only, and functional operation of the device at these or any other conditions beyond those indicated in the operational sections of the specifications is not implied. Exposure to absolute maximum rating conditions for extended periods may affect device reliability.

## DC ELECTRICAL CHARACTERISTICS—MAX2320/MAX2321/MAX2326

(V<sub>CC</sub> = +2.7V to +3.6V, R<sub>RBIAS</sub> = R<sub>RINA</sub> = 20kΩ, no RF signals applied, BUFFEN = low, LO buffer outputs connected to V<sub>CC</sub> through 50Ω resistors, all other RF and IF outputs connected to V<sub>CC</sub>, T<sub>A</sub> = -40°C to +85°C, unless otherwise noted. Typical values are at V<sub>CC</sub> = +2.75V and T<sub>A</sub> = +25°C, unless otherwise noted.)

PARAMETER	SYMBOL	CONDITIONS			MIN	TYP	MAX	UNITS	
Supply Voltage	V <sub>CC</sub>				+2.7		+3.6	V	
Operating Supply Current (Note 1)	I <sub>CC</sub>	High-gain, high-linearity modes	PCS band	MAX2320/6		20	25.3	mA	
				MAX2321		24	30.8		
			Cellular band	MAX2320/1		20	25.3		
				MAX2326		21	25.5		
			High-gain, low-linearity paging modes	PCS band	MAX2320/6		15		19.5
					MAX2321		19		25
		Cellular band		MAX2320/1		15	19.5		
				MAX2326		15.5	20		
		Low-gain, high-linearity modes	PCS band	MAX2320/6		17	21.5		
				MAX2321		21	26		
			Cellular band	MAX2320/1		17	21.5		
				MAX2326		17.5	21.5		
FM mode					14	18.5			
LO Buffer Supply Current	I <sub>LOBUF</sub>	Additional current for BUFFEN = high		Cellular band MAX2320/1		5	7.5	mA	
				Cellular band MAX2326		5.5	8.5		
				PCS band MAX2320/1/6		5	7.5		
Shutdown Supply Current	I <sub>SHDN</sub>	(Note 1)				0.1	20	μA	
Digital Input Logic High	V <sub>IH</sub>				2.0			V	
Digital Input Logic Low	V <sub>IL</sub>						0.6	V	
Digital Input Current High	I <sub>IH</sub>						5	μA	
Digital Input Current Low	I <sub>IL</sub>				-35			μA	

# Adjustable, High-Linearity, SiGe Dual-Band LNA/Mixer ICs

MAX2320/21/22/24/26/27

## DC ELECTRICAL CHARACTERISTICS—MAX2322/MAX2324

( $V_{CC} = +2.7V$  to  $+3.6V$ ,  $R_{RBIAS} = R_{RLNA} = 20k\Omega$ , no RF signals applied,  $BUFFEN = low$ , LO buffer outputs connected to  $V_{CC}$  through  $50\Omega$  resistors, all other RF and IF outputs connected to  $V_{CC}$ ,  $T_A = -40^\circ C$  to  $+85^\circ C$ , unless otherwise noted. Typical values are at  $V_{CC} = +2.75V$  and  $T_A = +25^\circ C$ , unless otherwise noted.)

PARAMETER	SYMBOL	CONDITIONS		MIN	TYP	MAX	UNITS
Supply Voltage	$V_{CC}$			+2.7		+3.6	V
Operating Supply Current (Note 1)	$I_{CC}$	High-gain, high-linearity modes	PCS band (MAX2322)	LOX2 = low	20	25.3	mA
				LOX2 = high	24	30.8	
			Cellular band (MAX2324)		20	25.3	
		High-gain, low-linearity paging modes	PCS band (MAX2322)	LOX2 = low	15	19.5	
				LOX2 = high	19	25	
			Cellular band (MAX2324)		15	19.5	
		Low-gain, high-linearity modes	PCS band (MAX2322)	LOX2 = low	17	21.5	
LOX2 = high	21			26			
Cellular band (MAX2324)		17	21.5				
FM mode (MAX2324 only)			14.5	18.5			
LO Buffer Supply Current	$I_{LOBUF}$	Additional current for $BUFFEN = high$			5	7.5	mA
Shutdown Supply Current	$I_{SHDN}$	(Note 1)			0.1	20	$\mu A$
Digital Input Logic High	$V_{IH}$			2.0			V
Digital Input Logic Low	$V_{IL}$					0.6	V
Digital Input Current High	$I_{IH}$					5	$\mu A$
Digital Input Current Low	$I_{IL}$			-35			$\mu A$
Digital Output Logic High	$V_{OH}$	MAX2324 only		1.7			V
Digital Output Logic Low	$V_{OL}$	MAX2324 only				0.4	V
Digital Output Current High	$I_{OH}$	MAX2324 only		30			$\mu A$
Digital Output Current Low	$I_{OL}$	MAX2324 only, $V_{MODEOUT} = 2.4V$				-100	$\mu A$

## DC ELECTRICAL CHARACTERISTICS—MAX2327

( $V_{CC} = +2.7V$  to  $+3.6V$ ,  $R_{RBIAS} = R_{RLNA} = 20k\Omega$ , no RF signals applied,  $BUFFEN = low$ , LO buffer outputs connected to  $V_{CC}$  through  $50\Omega$  resistors, all other RF and IF outputs connected to  $V_{CC}$ ,  $T_A = -40^\circ C$  to  $+85^\circ C$ , unless otherwise noted. Typical values are at  $V_{CC} = +2.75V$  and  $T_A = +25^\circ C$ , unless otherwise noted.)

PARAMETER	SYMBOL	CONDITIONS		MIN	TYP	MAX	UNITS
Supply Voltage	$V_{CC}$			+2.7		+3.6	V
Operating Supply Current (Note 1)	$I_{CC}$	High-gain mode	PCS band		15	19.5	mA
			Cellular band		15	19.5	
		FM mode			14.5	18.5	
LO Buffer Supply Current	$I_{LOBUF}$	Additional current for $BUFFEN = high$			5	7.5	mA
Shutdown Supply Current	$I_{SHDN}$	(Note 1)			0.1	20	$\mu A$
Digital Input Logic High	$V_{IH}$			2.0			V
Digital Input Logic Low	$V_{IL}$					0.6	V
Digital Input Current High	$I_{IH}$					5	$\mu A$
Digital Input Current Low	$I_{IL}$			-35			$\mu A$

# Adjustable, High-Linearity, SiGe Dual-Band LNA/Mixer ICs

## AC ELECTRICAL CHARACTERISTICS—MAX2320/MAX2321/MAX2326

(MAX232\_ EV kit,  $V_{CC} = +2.75V$ ,  $f_{LNAINH} = f_{MIXINH} = 1960MHz$ ,  $f_{LNAINL} = f_{MIXINL} = 881MHz$ ,  $f_{LOLIN} = 1091MHz$  (digital mode),  $f_{LOLIN} = 991MHz$  (FM mode),  $f_{LOHIN} = 1750MHz$  (MAX2320, MAX2322 with LOX2 = low, MAX2326 with BAND = low, MAX2327),  $f_{LOHIN} = 1085MHz$  (MAX2321 with BAND = low, MAX2322 with LOX2 = high),  $f_{LOHIN} = 1091MHz$  (MAX2321 with BAND = high),  $f_{LOHIN} = 2182MHz$  (MAX2326 with BAND = high), LO input power = -7dBm (MAX2320/MAX2326), 50Ω system,  $T_A = +25^{\circ}C$ , unless otherwise noted.) (Note 2)

PARAMETER	SYMBOL	CONDITIONS		MIN	-3σ	TYP	+3σ	MAX	UNITS
Low-Band RF Frequency Range (Note 3)				800				1000	MHz
High-Band RF Frequency Range (Note 3)				1800				2500	MHz
Low-Band LO Frequency Range (Note 3)				700				1150	MHz
High-Band LO Frequency Range (Note 3)				1600				2300	MHz
IF Frequency Range (Note 3)				50				400	MHz
<b>LNA PERFORMANCE</b>									
<b>HIGH-GAIN, HIGH-LINEARITY MODES (Note 1)</b>									
Gain (Note 4)	G	$T_A = +25^{\circ}C$	PCS	13	14.5	16			dB
			Cellular	14	15	16			
		$T_A = -40^{\circ}C$ to $+85^{\circ}C$	PCS	11.5	14.5	17			
			Cellular	13	15	16.5			
Gain Variation Over Temperature Relative to $+25^{\circ}C$		$T_A = -40^{\circ}C$ to $+85^{\circ}C$	PCS	±0.5					dB
			Cellular	±0.5					
Noise Figure (Note 5)	NF	PCS			1.8	2	2.1		dB
		Cellular			1.3	1.4	1.5		
Input Third-Order Intercept (Notes 5, 6)	IIP3	$T_A = T_{MIN}$ to $T_{MAX}$	PCS	7	+8				dBm
			Cellular	6	+8				
Input 1dB Compression	$P_{OUT}$ 1dB	$T_A = T_{MIN}$ to $T_{MAX}$	PCS	-11	-10				dBm
			Cellular	-11	-10				
<b>HIGH-GAIN, LOW-LINEARITY PAGING MODES AND FM MODE (Note 1)</b>									
Gain (Note 4)	G	PCS			13.5				dB
		Cellular			14.5				
Gain Variation Over Temperature Relative to $+25^{\circ}C$		$T_A = -40^{\circ}C$ to $+85^{\circ}C$	PCS	±0.5					dB
			Cellular	±0.5					
Noise Figure (Note 5)		PCS			1.9	2.1	2.2		dB
		Cellular			1.4	1.5	1.6		

# Adjustable, High-Linearity, SiGe Dual-Band LNA/Mixer ICs

**MAX2320/21/22/24/26/27**

## AC ELECTRICAL CHARACTERISTICS (continued)

(MAX232\_ EV kit,  $V_{CC} = +2.75V$ ,  $f_{LNAINH} = f_{MIXINH} = 1960MHz$ ,  $f_{LNAINL} = f_{MIXINL} = 881MHz$ ,  $f_{LOLIN} = 1091MHz$  (digital mode),  $f_{LOLIN} = 991MHz$  (FM mode),  $f_{LOHIN} = 1750MHz$  (MAX2320, MAX2322 with LOX2 = low, MAX2326 with  $\overline{BAND} = low$ , MAX2327),  $f_{LOHIN} = 1085MHz$  (MAX2321 with  $\overline{BAND} = low$ , MAX2322 with LOX2 = high),  $f_{LOHIN} = 1091MHz$  (MAX2321 with  $\overline{BAND} = high$ ),  $f_{LOHIN} = 2182MHz$  (MAX2326 with  $\overline{BAND} = high$ ), LO input power = -7dBm (MAX2320/MAX2326), 50Ω system,  $T_A = +25^\circ C$ , unless otherwise noted.) (Note 2)

PARAMETER	SYMBOL	CONDITIONS		MIN	-3σ	TYP	+3σ	MAX	UNITS
Input Third-Order Intercept (Notes 5, 6)		PCS				+6.5			dBm
		Cellular				+6			
<b>LOW-GAIN, HIGH-LINEARITY MODES</b> (Note 1)									
Gain (Note 4)	G	PCS				-2			dB
		Cellular				-1.5			
Gain Variation Over Temperature Relative to +25°C		$T_A = -40^\circ C$ to +85°C	PCS			0.5			dB
			Cellular			0.5			
Noise Figure (Note 5)	NF	PCS				5	5.5	6	dB
		Cellular				4	4.25	4.5	
Input Third-Order Intercept (Notes 5, 6)	IIP3	PCS			+10.5	+11.5	+12.5		dBm
		Cellular			+11.5	+12.5	+13.5		
<b>MIXER PERFORMANCE</b>									
<b>HIGH-GAIN, HIGH-LINEARITY, AND LOW-GAIN MODES</b> (Note 1)									
Gain (Note 4)	G	$T_A = +25^\circ C$ , PCS	Without doubler	11	11.8	12.5	13.2	14	dB
			With doubler	10.5	11.1	12	12.9	13.5	
		$T_A = -40^\circ C$ to +85°C, PCS	Without doubler	10	10.8	12.5	14.3	15.3	
			With doubler	9.6	10.4	12	13.1	14.3	
		$T_A = +25^\circ C$ , cellular		12	12.7	13.4	14.0	14.7	
$T_A = -40^\circ C$ to +85°C, cellular		11.3	11.9	13.4	15.5	16.5			
Gain Variation Over Temperature Relative to +25°C (Note 5)		$T_A = -40^\circ C$ to +85°C	PCS			±1			dB
			Cellular			±1			
Noise Figure	NF	PCS	Without doubler			7.5	7.8	8	dB
			With doubler			11	12.3	13.5	
		Cellular	Without divider			7.5	8.1	8.5	
			With divider			7.8	8.4	8.8	
Input Third-Order Intercept (Notes 5, 6)	IIP3	PCS, $T_A = T_{MIN}$ to $T_{MAX}$	Without doubler	1.8	2.4	+4			dBm
			With doubler	1.4	2.8	+4.7			
		Cellular, $T_A = T_{MIN}$ to $T_{MAX}$		1	1.8	3.2			
Input dB Compression		PCS	$T_A = T_{MIN}$ to $T_{MAX}$	-11	-10				dBm
				Cellular	-12	-10.7			

# Adjustable, High-Linearity, SiGe Dual-Band LNA/Mixer ICs

## AC ELECTRICAL CHARACTERISTICS (continued)

(MAX232\_EV kit,  $V_{CC} = +2.75V$ ,  $f_{LNAINH} = f_{MIXINH} = 1960MHz$ ,  $f_{LNAINL} = f_{MIXINL} = 881MHz$ ,  $f_{LOLIN} = 1091MHz$  (digital mode),  $f_{LOLIN} = 991MHz$  (FM mode),  $f_{LOHIN} = 1750MHz$  (MAX2320, MAX2322 with LOX2 = low, MAX2326 with BAND = low, MAX2327),  $f_{LOHIN} = 1085MHz$  (MAX2321 with BAND = low, MAX2322 with LOX2 = high),  $f_{LOHIN} = 1091MHz$  (MAX2321 with BAND = high),  $f_{LOHIN} = 2182MHz$  (MAX2326 with BAND = high), LO input power = -7dBm (MAX2320/MAX2326), 50Ω system,  $T_A = +25°C$ , unless otherwise noted.) (Note 2)

PARAMETER	SYMBOL	CONDITIONS	MIN	-3σ	TYP	+3σ	MAX	UNITS	
<b>HIGH-GAIN, LOW-LINEARITY, AND LOW-GAIN MODES</b> (Note 1)									
Gain (Note 4)	G	PCS	Without doubler	10.6	11.3	12	12.1	12.8	dB
			With doubler	10.2	10.8	11.5	12.4	13.1	
		Cellular Band	11.2	12.1	13	13.8	14.7		
Gain Variation Over Temperature Relative to +25°C		$T_A = -40°C$ to +85°C	PCS			±1		±1	dB
			Cellular			±1		±1	
Noise Figure	NF	PCS	Without doubler			7.2	7.5	7.6	dB
			With doubler (Note 7)			10.5	12	13.4	
		Cellular	Without divider			7	7.2	7.6	
			With divider			7.5	7.7	8.1	
Input Third-Order Intercept	IIP3	PCS	Without doubler			+1		dBm	
			With doubler			+2.2			
		Cellular			+1.0				
<b>FM MODE</b> (Note 1)									
Gain (Note 4)	G	$T_A = +25°C$	9.7	10.4	11.2	11.9	12.7	dB	
		$T_A = -40°C$ to +85°C	7.8	9.0	11.2	14.0	15.4		
Noise Figure	NF				10.6	11.1	11.5	dB	
Input Third-Order Intercept (Notes 5, 6)	IIP3	$T_A = -40°C$ to +85°C	2.3	3.2	4.9			dBm	
<b>LO BUFFER PERFORMANCE (BUFFEN = HIGH)</b>									
LO Output Level		Load = 100Ω pullup resistor			-12			dBm	
		BUFFEN = GND			-44				
LO_OUT Even Harmonic Distortion					-31			dBc	
LO Emissions at LNA Input Port		Interstage filter rejection = 20dB			-50			dBm	

**Note 1:** See Tables 1–5 for operational mode selection.

**Note 2:** A total of 36 devices from 3 different wafer lots are used to determine the standard deviation. The lots were selected to represent worst-case process conditions.

**Note 3:** Operation is characterized for the frequencies specified in the conditions; for other frequencies in the band, see Tables 8–12 for LNA and mixer S parameters.

**Note 4:** Guaranteed by design, characterization, and production functional test.

**Note 5:** Guaranteed by design and characterization.

**Note 6:** For cellular band, RF inputs are -25dBm each tone at 881MHz and 882MHz,  $f_{LO} = 1091MHz$ . For PCS band, RF inputs are -25dBm each tone at 1960MHz and 1961MHz,  $f_{LO} = 2170MHz$ . For IIP3 vs.  $I_{CC}$  trade-off, see *Typical Operating Characteristics*.

# Adjustable, High-Linearity, SiGe Dual-Band LNA/Mixer ICs

## Typical Operating Characteristics

(MAX232\_EV kit,  $V_{CC} = +2.75V$ ,  $f_{LNAINH} = f_{MIXINH} = 1960MHz$ ,  $f_{LNAINL} = f_{MIXINL} = 881MHz$ ,  $f_{LOHIN} = 1750MHz$ ,  $f_{LOLIN} = 1091MHz$  (digital modes),  $f_{LOLIN} = 991MHz$  (FM mode), LO input power =  $-7dBm$ ,  $50\Omega$  system, all measurements include matching component losses but not connector and trace losses,  $T_A = +25^\circ C$ , unless otherwise noted.)

MAX2320/21/22/24/26/27

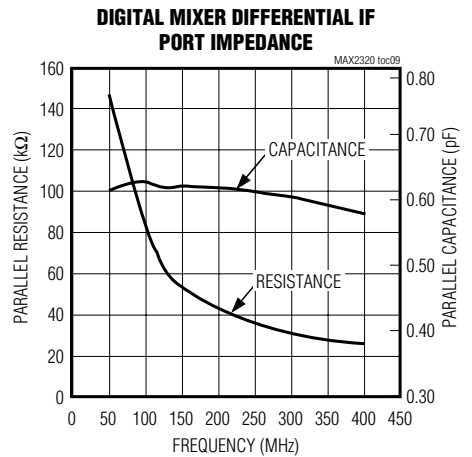
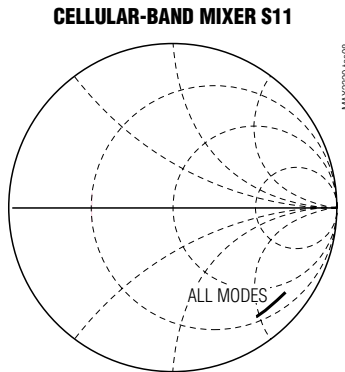
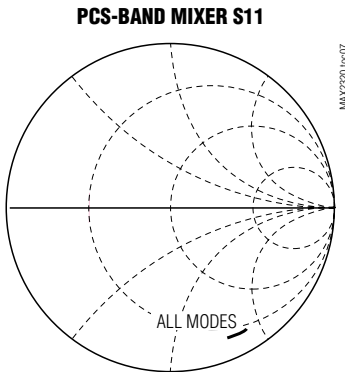
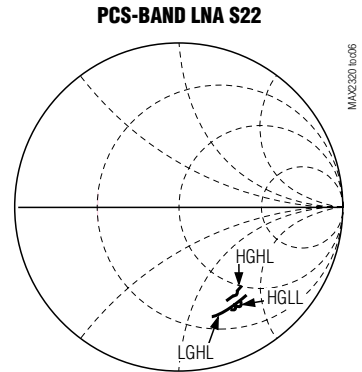
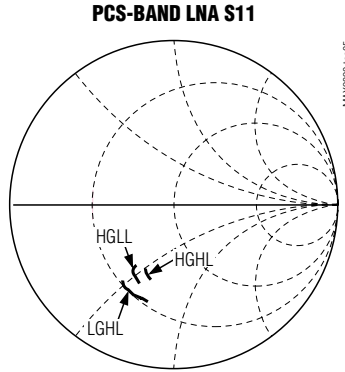
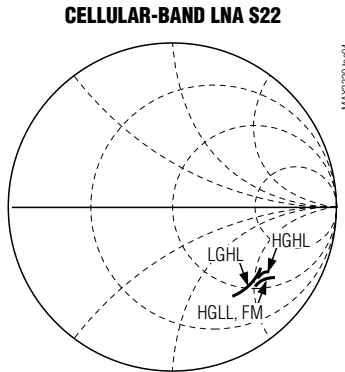
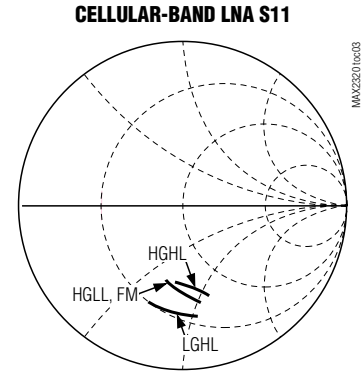
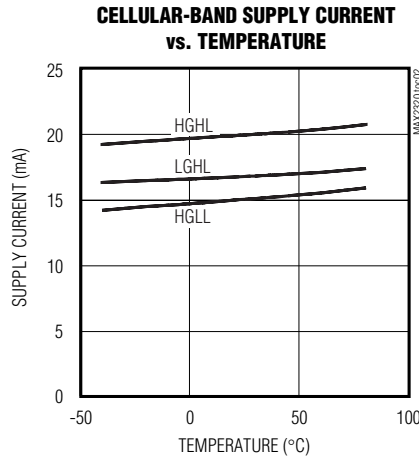
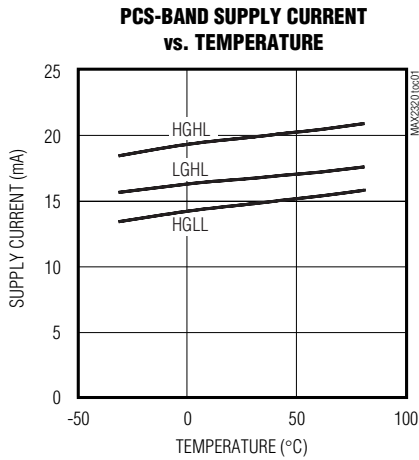

# Adjustable, High-Linearity, SiGe Dual-Band LNA/Mixer ICs

## Typical Operating Characteristics (continued)

(MAX232\_EV kit,  $V_{CC} = +2.75V$ ,  $f_{LNAINH} = f_{MIXINH} = 1960MHz$ ,  $f_{LNAINL} = f_{MIXINL} = 881MHz$ ,  $f_{LOHIN} = 1750MHz$ ,  $f_{LOLIN} = 1091MHz$  (digital modes),  $f_{LOLIN} = 991MHz$  (FM mode), LO input power = -7dBm, 50Ω system, all measurements include matching component losses but not connector and trace losses,  $T_A = +25^\circ C$ , unless otherwise noted.)

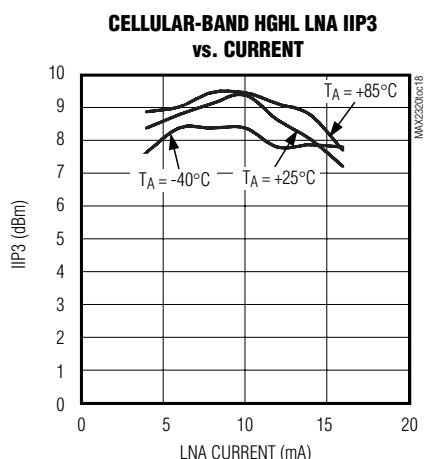
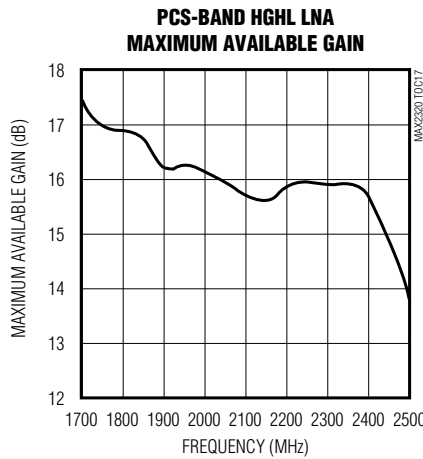
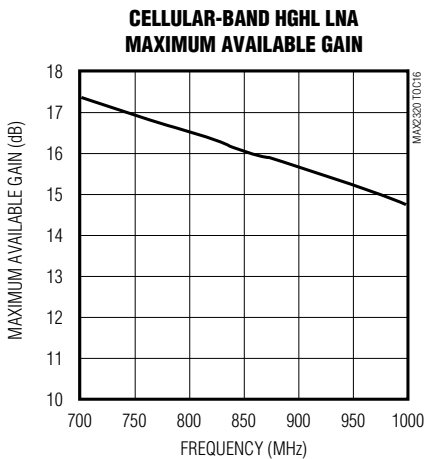
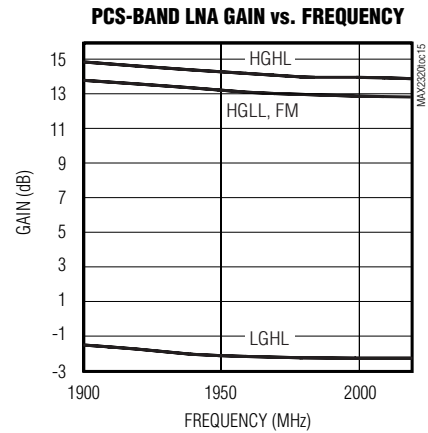
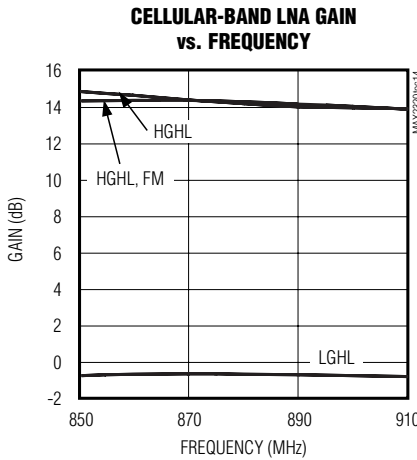
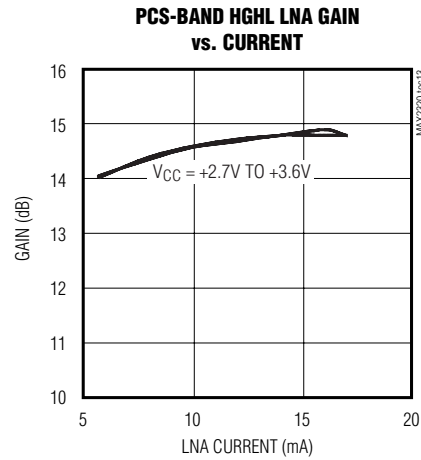
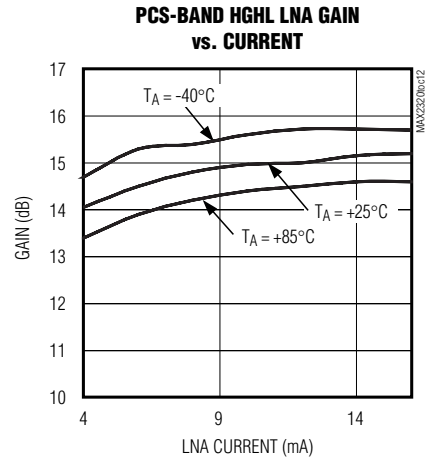
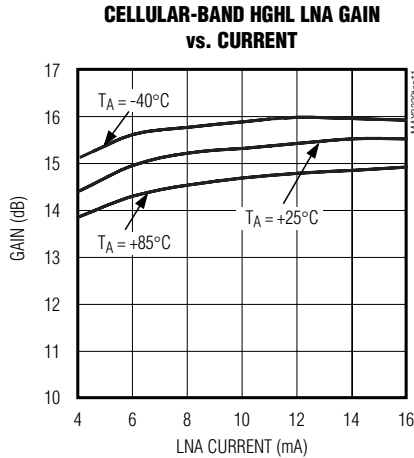
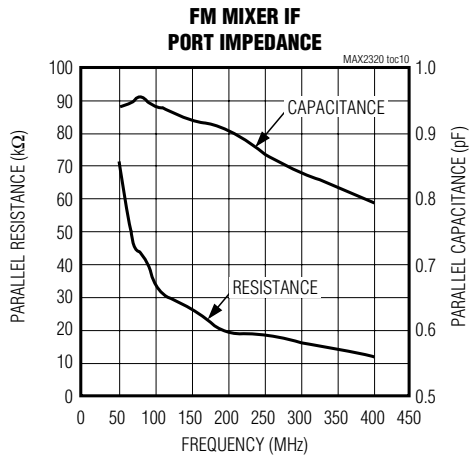



# Adjustable, High-Linearity, SiGe Dual-Band LNA/Mixer ICs

## Typical Operating Characteristics (continued)

(MAX232\_EV kit,  $V_{CC} = +2.75V$ ,  $f_{LNAINH} = f_{MIXINH} = 1960MHz$ ,  $f_{LNAINL} = f_{MIXINL} = 881MHz$ ,  $f_{LOINH} = 1750MHz$ ,  $f_{LOLIN} = 1091MHz$  (digital modes),  $f_{LOLIN} = 991MHz$  (FM mode), LO input power =  $-7dBm$ ,  $50\Omega$  system, all measurements include matching component losses but not connector and trace losses,  $T_A = +25^\circ C$ , unless otherwise noted.)

MAX2320/21/22/24/26/27

**CELLULAR-BAND HGHL LNA IIP3 vs. CURRENT**

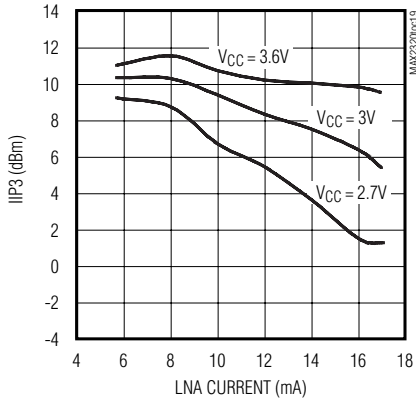

**PCS-BAND HGHL LNA IIP3 vs. CURRENT**

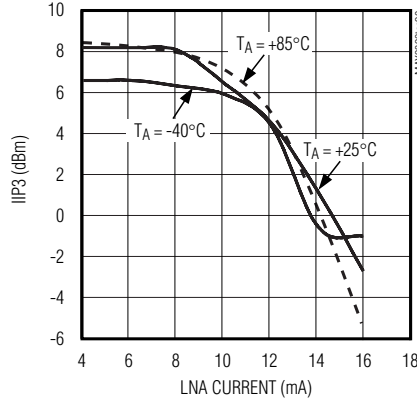

**PCS-BAND HGHL LNA IIP3 vs. CURRENT**

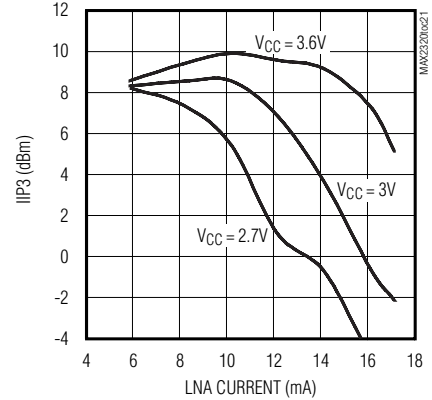

**PCS-BAND HGHL LNA IIP3 vs. CURRENT**

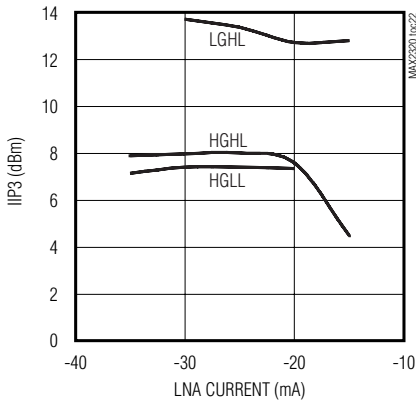

**CELLULAR-BAND HGHL LNA NOISE FIGURE vs. FREQUENCY**

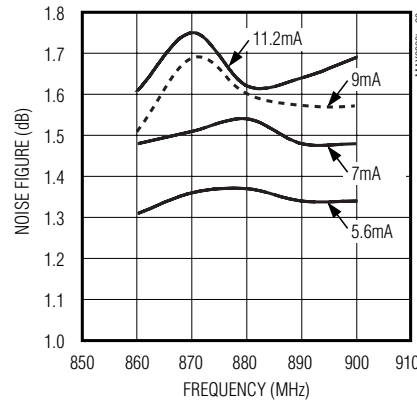

**CELLULAR-BAND HGHL LNA NOISE FIGURE vs. FREQUENCY**

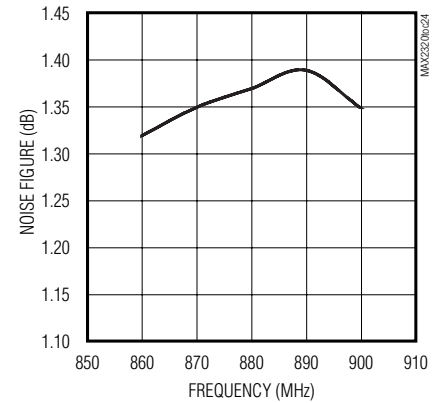

**PCS-BAND HGHL NOISE FIGURE vs. FREQUENCY**

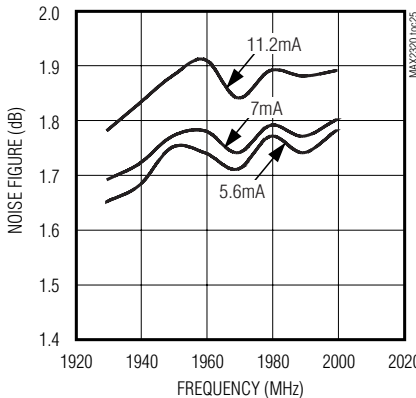

**PCS-BAND HGHL LNA NOISE FIGURE vs. FREQUENCY**

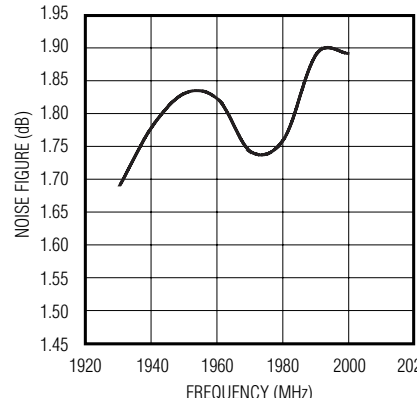

**CELLULAR-BAND HGHL MIXER CONVERSION GAIN vs. CURRENT**

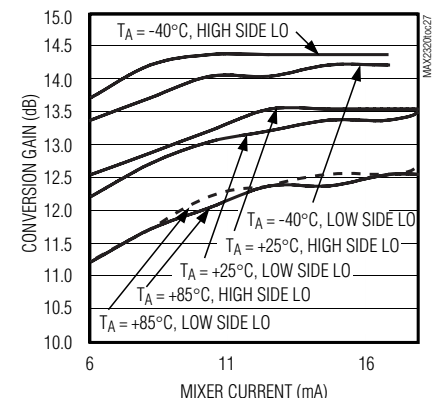

# Adjustable, High-Linearity, SiGe Dual-Band LNA/Mixer ICs

## Typical Operating Characteristics (continued)

(MAX2322\_EV kit,  $V_{CC} = +2.75V$ ,  $f_{LNAINH} = f_{MIXINH} = 1960MHz$ ,  $f_{LNAINL} = f_{MIXINL} = 881MHz$ ,  $f_{LOHIN} = 1750MHz$ ,  $f_{LOLIN} = 1091MHz$  (digital modes),  $f_{LOLIN} = 991MHz$  (FM mode), LO input power = -7dBm, 50Ω system, all measurements include matching component losses but not connector and trace losses,  $T_A = +25^\circ C$ , unless otherwise noted.)

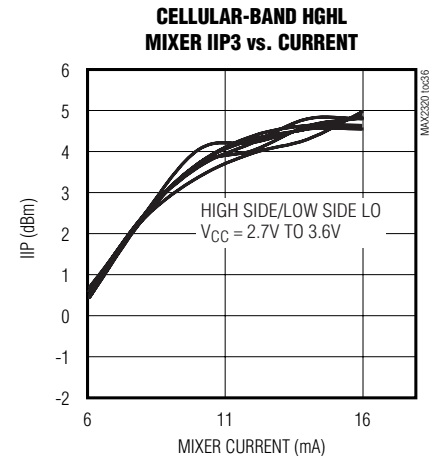
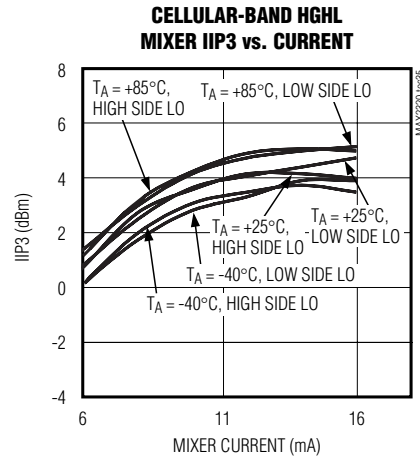
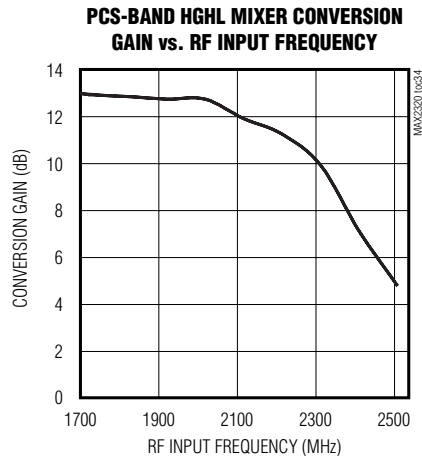
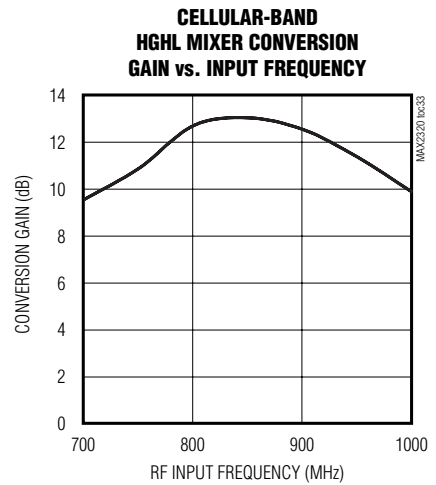
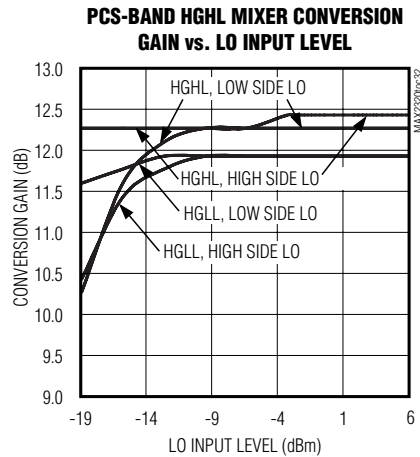
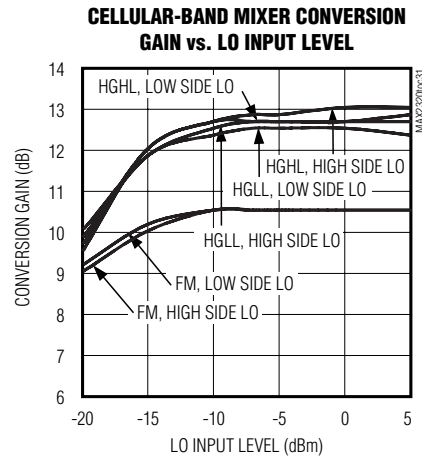
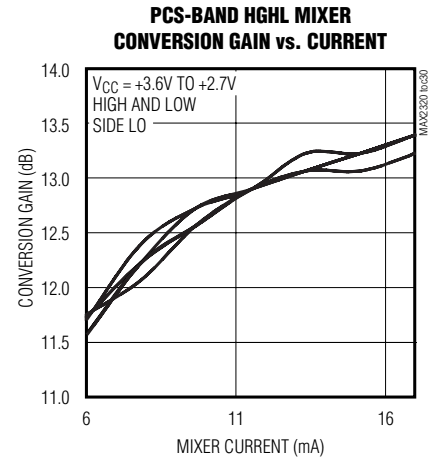
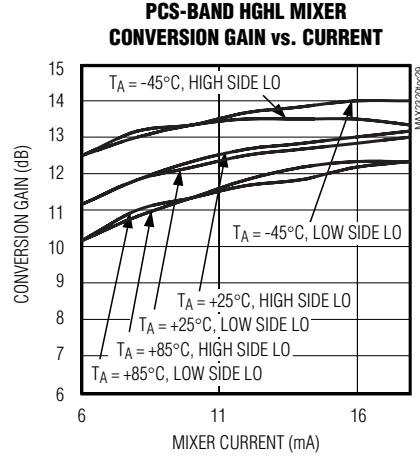
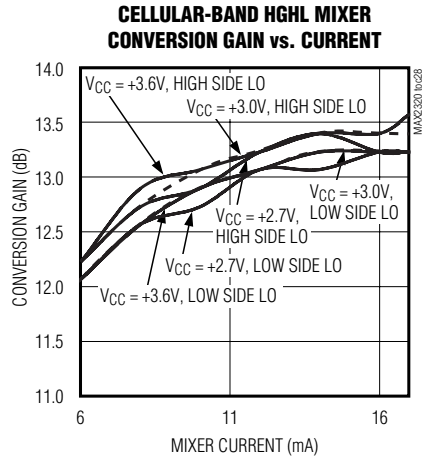

# Adjustable, High-Linearity, SiGe Dual-Band LNA/Mixer ICs

## Typical Operating Characteristics (continued)

(MAX232\_ EV kit,  $V_{CC} = +2.75V$ ,  $f_{LNAINH} = f_{MIXINH} = 1960MHz$ ,  $f_{LNAINL} = f_{MIXINL} = 881MHz$ ,  $f_{LOINH} = 1750MHz$ ,  $f_{LOINL} = 1091MHz$  (digital modes),  $f_{LOLIN} = 991MHz$  (FM mode), LO input power =  $-7dBm$ ,  $50\Omega$  system, all measurements include matching component losses but not connector and trace losses,  $T_A = +25^\circ C$ , unless otherwise noted.)

MAX2320/21/22/24/26/27

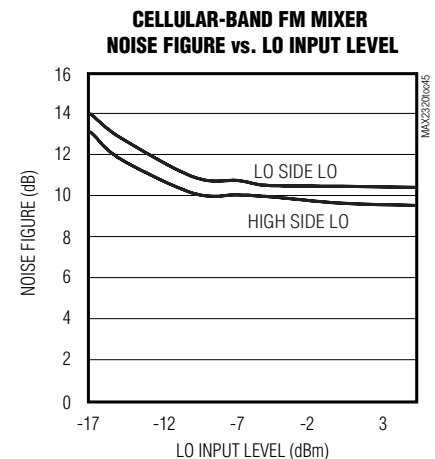
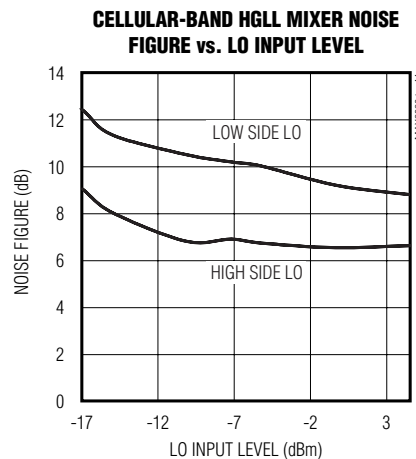
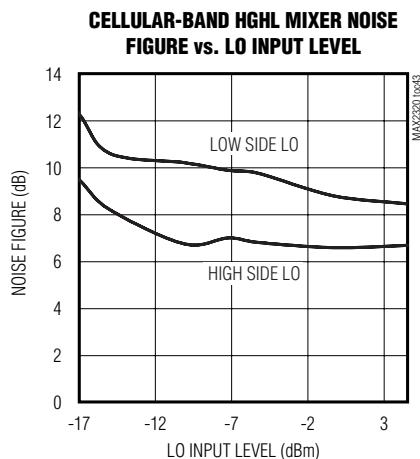
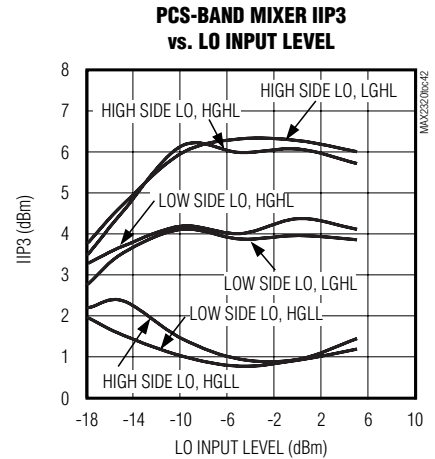
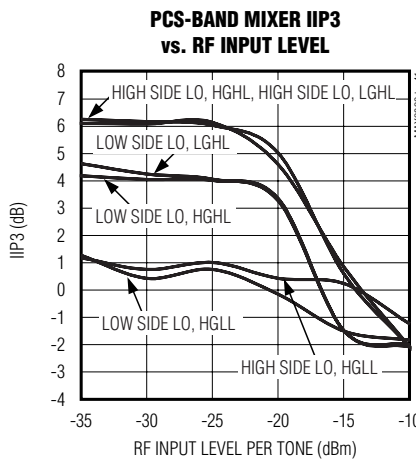
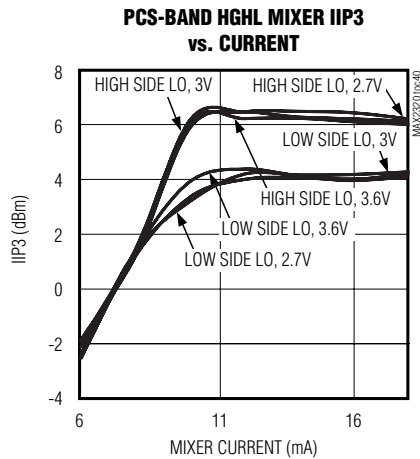
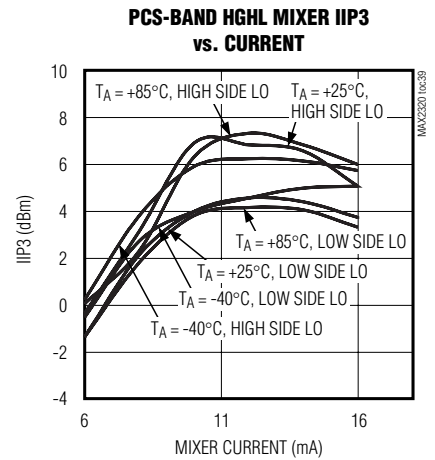
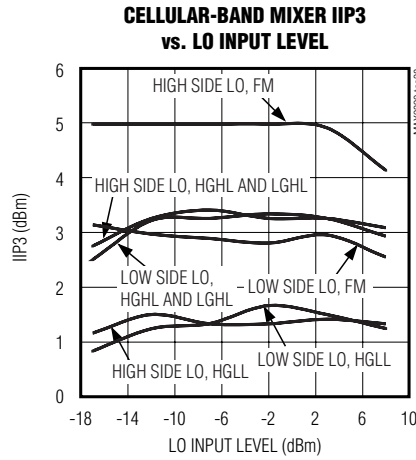
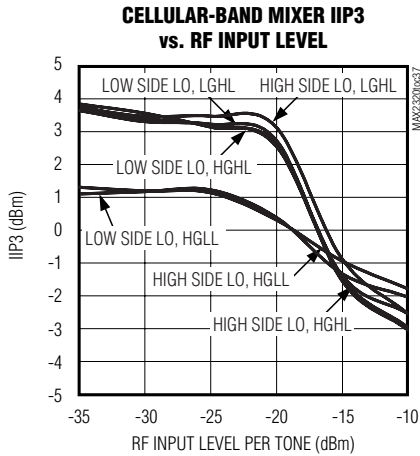

# Adjustable, High-Linearity, SiGe Dual-Band LNA/Mixer ICs

## Typical Operating Characteristics (continued)

(MAX232\_EV kit,  $V_{CC} = +2.75V$ ,  $f_{LNAINH} = f_{MIXINH} = 1960MHz$ ,  $f_{LNAINL} = f_{MIXINL} = 881MHz$ ,  $f_{LOHIN} = 1750MHz$ ,  $f_{LOLIN} = 1091MHz$  (digital modes),  $f_{LOLIN} = 991MHz$  (FM mode), LO input power = -7dBm, 50Ω system, all measurements include matching component losses but not connector and trace losses,  $T_A = +25^\circ C$ , unless otherwise noted.)

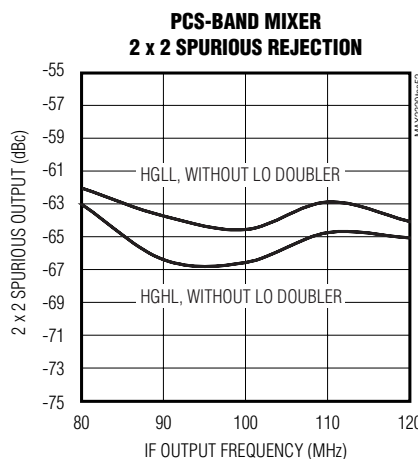
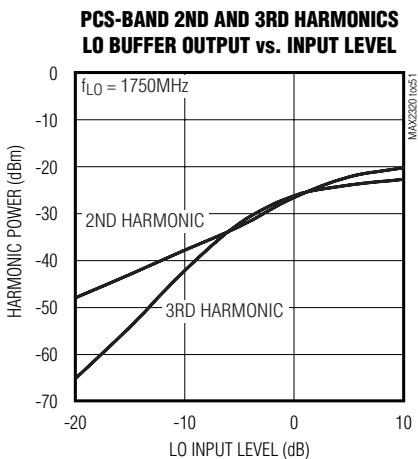
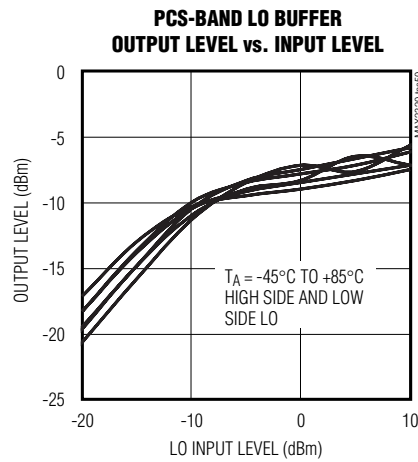
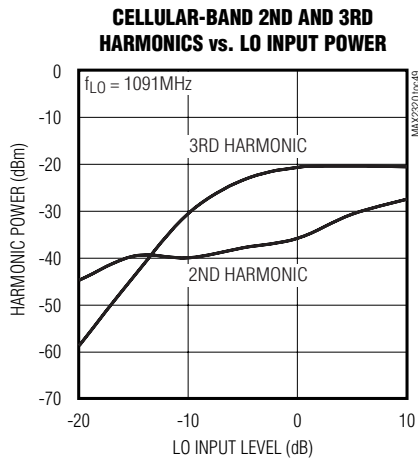
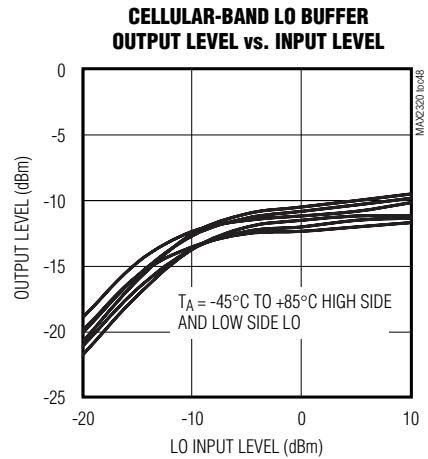
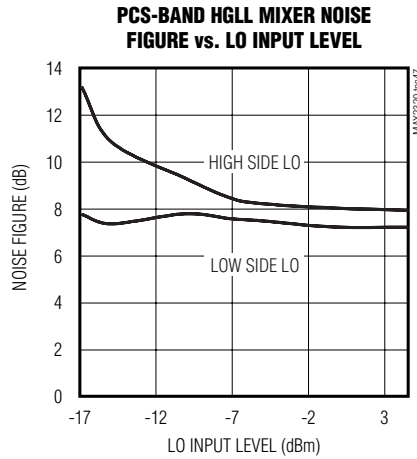
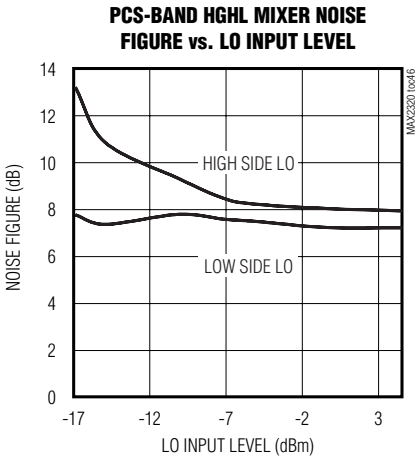

# Adjustable, High-Linearity, SiGe Dual-Band LNA/Mixer ICs

## Pin Description

MAX2320/21/22/24/26/27

PIN				NAME	FUNCTION
MAX2320 MAX2321 MAX2326	MAX2322	MAX2324	MAX2327		
1	1	—	1	LNAOUTH	High-Band LNA Output. Connect a pull-up inductor to V <sub>CC</sub> and an external series capacitor as part of the matching network.
2	—	2	2	LNAOUTL	Low-Band LNA Output. Connect a pull-up inductor to V <sub>CC</sub> and an external series capacitor as part of the matching network.
3	3	3	—	RLNA	LNA Bias-Setting Resistor Connection. For nominal bias, connect a 20k $\Omega$ resistor to ground. The resistor value controls the LNA's linearity in high-gain, high-linearity modes.
4	4	—	4	LNAINH	High-Band RF Input. Requires a blocking capacitor and a matching network. The capacitor may be used as part of the matching network.
—	—	4	—	MODEOUT	Logic Output. Indicates mode of operation. V <sub>MODEOUT</sub> = high in FM mode.
5	—	5	5	LNAINL	Low-Band RF Input. Requires a blocking capacitor and a matching network. The capacitor may be used as part of the matching network.
—	6	6	7	$\overline{\text{SHDN}}$	Shutdown Logic Input. See <i>Detailed Description</i> for control modes.
6	—	—	6	$\overline{\text{BAND}}$	Band-Select Logic Input. See <i>Detailed Description</i> for control modes.
7	7	7	—	LIN	Linearity-Select Logic Input. See <i>Detailed Description</i> for control modes.
8	8	8	—	GAIN	Gain-Select Logic Input. See <i>Detailed Description</i> for control modes.
—	—	—	8	MODE	Cellular-Band Mode Select Logic Input. See <i>Detailed Description</i> for control modes.
9	—	9	9	LOLIN	Low-Frequency LO Input. Used in FM mode on all parts and in cellular digital mode for MAX2320/MAX2324.
10	10	—	10	LOHIN	High-Frequency LO Input. For MAX2321, used in cellular digital mode and in PCS mode with the doubler active. For MAX2320/MAX2327, used in PCS mode without the doubler. For MAX2322, used with or without the doubler. For MAX2326, used in PCS mode and cellular digital mode with the divide-by-two.

# Adjustable, High-Linearity, SiGe Dual-Band LNA/Mixer ICs

MAX2320/21/22/24/26/27

## Pin Description (continued)

PIN				NAME	FUNCTION
MAX2320 MAX2321 MAX2326	MAX2322	MAX2324	MAX2327		
11	11	—	11	LOHOUT	High-Frequency LO Buffer Output. Open-collector output requires pull-up inductor or pull-up resistor of 100Ω or less. Reactive match to the load delivers maximum power.
12	—	12	12	LOLOUT	Low-Frequency LO Buffer Output. Open-collector output requires pull-up inductor or pull-up resistor of 100Ω or less. Reactive match to the load delivers maximum power.
13	—	13	13	FMOUT	FM Mixer Output. Requires a pull-up inductor to V <sub>CC</sub> and a series capacitor as part of the matching network.
—	13	—	—	LOX2	LO Doubler Logic Input. Drive LOX2 high to enable the LO doubler.
14	14	14	14	V <sub>CC</sub>	Power Supply. Bypass with a 1000pF capacitor as close to the pin as possible.
15	15	15	15	BUFFEN	LO Output Buffer Enable. The LO buffers are controlled separately from the rest of the IC. Drive BUFFEN high to power up the LO output buffer associated with the selected LO input port.
16, 17	16, 17	16, 17	—	CDMA-, CDMA+	CDMA Mixer Differential Outputs. Require pull-up inductors and series capacitors as part of the matching network.
—	—	—	16, 17	IFOUT+, IFOUT-	Mixer Differential Outputs. Require pull-up inductors and series capacitors as part of the matching network.
18	18	18	18	RBIAS	Bias-Setting Resistor Connection. For nominal bias, connect 20kΩ resistor to ground. The resistor value controls the digital LNA's linearity in low-gain, digital, or FM mode, and controls the mixers in all modes.
19	—	19	19	MIXINL	Low-Band Mixer Input. Requires a blocking capacitor and a matching network. The capacitor may be used as part of the matching network.
20	20	—	20	MIXINH	High-Band Mixer Input. Requires a blocking capacitor and a matching network. The capacitor may be used as part of the matching network.
—	2, 5, 9, 12, 19	1, 10, 11, 20	3	N.C.	No Connection. Do not make any connection to these pins.
Slug	Slug	Slug	Slug	GND	Ground Reference for RF, DC, and Logic Inputs. Solder the slug evenly to the board ground plane.

# Adjustable, High-Linearity, SiGe Dual-Band LNA/Mixer ICs

MAX2320/21/22/24/26/27

## Detailed Description

### Low-Noise Amplifier

Within its operating bands, each device in the MAX2320 family (except the MAX2327) has three modes of LNA operation: high gain, high linearity (HGHL); high gain, low linearity (HGLL); and low gain, high linearity (LGHL). The logic inputs control the LNA mode as described in the *AC Electrical Characteristics*. Use HGHL mode when extra-high LNA linearity is required for cross-modulation suppression. Use HGLL mode when the transmitter is off and cross-modulation is not a concern. When the LNA changes modes, the input VSWR change is minimal. Use LGHL mode for receiving large signals and when high sensitivity is not required. The MAX2327 LNA has only an HGLL mode. Adjust the HGHL mode LNA linearity by changing RRLNA, and adjust linearity of the other modes by changing RRBIAS.

### Downconverter

The downconverters in these devices are double-balanced mixers. The PCS-band mixer and digital cellular-band mixer share the same IF output ports. The cellular band FM mixer has its own IF output to feed a different filter. Adjust the downconverter linearity and current by changing RRBIAS (see *Typical Operating Characteristics*). When the linearity requirement is high, the mode

control inputs increase the current in the downconverter. When the linearity requirement is not high, the current is lower.

### LO Output Buffers

The BUFFEN logic input turns the open-collector LO output buffers on and off. This feature saves current if the buffers are not required.

### Operational Modes

Each device has logic input pins that control the different operational modes listed in Tables 1–5.

### MAX2320/MAX2321/MAX2326 Operation

The MAX2320/MAX2321/MAX2326 are dual-band, triple-mode receivers that amplify and downconvert cellular- and PCS-band signals. They consist of cellular and PCS LNAs; cellular digital, cellular FM, and PCS digital mixers; and cellular and PCS LO buffers. The MAX2321 has an LO frequency doubler on-chip, so a single cellular-band VCO can be used for both the cellular- and PCS-band mixers. Selecting the PCS path activates the LO frequency doubler. The MAX2326 has an LO divide-by-two circuit, so a single PCS-band VCO can be used for both the cellular and PCS mixers. Selecting the cellular path activates the LO divide-by-two circuit. Three logic input pins—**BAND**, **GAIN**, and **LIN**—control eight operational modes of the LNAs and mixers. The modes are summarized in Table 1.

**Table 1. MAX2320/MAX2321/MAX2326 Operational Modes**

DESCRIPTION	BAND	GAIN	LIN
Shutdown. The entire part is shut down except for the LO buffer, which is controlled by BUFFEN.	L	L	L
Low-Gain, High-Linearity (LGHL) PCS Mode. The PCS LNA and mixer are in LGHL mode.	L	L	H
High-Gain, Low-Linearity (HGLL) PCS Mode. The LNA and mixer are in HGLL mode.	L	H	L
High-Gain, High-Linearity (HGHL) PCS Mode. The LNA and mixer are in HGHL mode.	L	H	H
High-Gain, Low-Linearity (HGLL) Cellular FM Mode. The cellular LNA is in HGLL mode. The FM mixer and associated LO buffer are selected.	H	L	L
Low-Gain, High-Linearity (LGHL) Cellular Digital Mode. The cellular LNA and mixer are in LGHL mode.	H	L	H
High-Gain, Low-Linearity (HGLL) Cellular Digital Mode. The cellular LNA and mixer are in HGLL mode.	H	H	L
High-Gain, High-Linearity (HGHL) Cellular Digital Mode. The cellular LNA and mixer are in HGHL mode.	H	H	H

**Note:** L = Logic Low; H = Logic High



# Adjustable, High-Linearity, SiGe Dual-Band LNA/Mixer ICs

## MAX2322 Operation

The MAX2322 is a lower-cost PCS-only version that can be installed as a drop-in replacement for the dual-band versions. It consists of a PCS LNA, PCS mixer, pin-selectable LO frequency doubler, and LO buffer. Logic input  $\overline{\text{SHDN}} = \text{VCC} / \text{GND}$  turns on/off the entire IC except the LO buffer. The LOX2 logic input controls the LO frequency doubler. LOX2 = GND disables the doubler when using a PCS band VCO, and LOX2 = VCC activates the doubler when using a cellular-band VCO. GAIN and LIN logic inputs control the MAX2322's three operational modes, as summarized in Table 2.

## MAX2324 Operation

The MAX2324 is a lower-cost cellular-only version that can be installed as a drop-in replacement for the dual-band versions. It consists of a cellular LNA, cellular digital mixer, cellular FM mixer, and LO buffer. A  $\overline{\text{SHDN}}$  logic input turns on/off the entire IC except the LO buffer. GAIN and LIN logic inputs control the MAX2324's three operational modes, as summarized in Table 3.

## MAX2327 Operation

The MAX2327 is similar to the MAX2320 except it only features an HGLL mode, and either LO output buffer is selectable during shutdown. It consists of PCS and cellular LNAs; PCS, cellular digital, and cellular FM mixers; and PCS and cellular LO buffers. A  $\overline{\text{SHDN}}$  logic input turns on/off the entire IC except the LO buffer.  $\overline{\text{BAND}}$  and MODE logic inputs control the MAX2327's three operational modes, as summarized in Table 4.

## Applications Information

### Cascaded LNA/Mixer Performance

The LNA and mixer design aims at optimizing cascaded performance in all gain and linearity modes. In high-gain, high-linearity mode, both the LNA and mixer have a low noise figure, high gain, and high linearity. The LNA has high gain to minimize the noise contribution of the mixer, thus increasing the receiver's sensitivity and extra-high linearity for superior cross-modulation suppression. The HGLL mode is used when the transmitter is off and cross-modulation is not a concern. In low-gain, high-linearity mode, the received signal is strong enough that linearity is the primary concern. The LNA gain is reduced for higher system linearity. Tables 5 and 6 summarize the cascaded performance.

### S Parameters

The S parameters are listed in Tables 7–11. An electronic copy is also available at [www.maxim-ic.com/MAX2320/S\\_table/](http://www.maxim-ic.com/MAX2320/S_table/).

Table 2. MAX2322 Operational Modes

OPERATIONAL MODE	GAIN	LIN
Not used.	L	L
Low-Gain, High-Linearity (LGHL) PCS Mode. The LNA and mixer are in LGHL mode.	L	H
High-Gain, Low-Linearity (HGLL) PCS Mode. The LNA and mixer are in HGLL mode.	H	L
High-Gain, High-Linearity (HGHL) PCS Mode. The LNA and mixer are in HGHL mode.	H	H

Note: L = Logic Low; H = Logic High

Table 3. MAX2324 Operational Modes

OPERATIONAL MODE	GAIN	LIN
FM Mode. The LNA is in HGLL mode. The FM mixer and the associated LO buffer are selected.	L	L
Low-Gain, High-Linearity (LGHL) Cellular Mode. The LNA and digital mixer are in LGHL mode.	L	H
High-Gain, Low-Linearity (HGLL) Cellular Mode. The LNA and digital mixer are in HGLL mode.	H	L
High-Gain, High-Linearity (HGHL) Cellular Mode. The LNA and digital mixer are in HGHL mode.	H	H

Note: L = Logic Low; H = Logic High

Table 4. MAX2327 Operational Modes

OPERATIONAL MODE	$\overline{\text{BAND}}$	MODE
Not used.	L	L
Digital PCS Mode. The LNA and mixer are in HGLL mode.	L	H
FM Mode. The cellular FM mixer is selected.	H	L
Digital Cellular Mode. The cellular digital mixer is selected.	H	H

Note: L = Logic Low; H = Logic High



# Adjustable, High-Linearity, SiGe Dual-Band LNA/Mixer ICs

## Layout Considerations

Keep RF signal lines as short as possible to minimize losses and radiation. Use high-Q components for the LNA input matching circuit to achieve the lowest possible

noise figure. At the digital mixer outputs, keep the differential signal lines together and of equal length to ensure signal balance. For best gain and noise performance, solder the slug evenly to the board ground plane.

MAX2320/21/22/24/26/27

**Table 5. Typical Cascaded Performance of Cellular-Band Receiver with 3dB Interstage Filter Loss**

PARAMETER	HIGH GAIN, HIGH LINEARITY	HIGH GAIN, LOW LINEARITY	LOW GAIN, HIGH LINEARITY	FM
Conversion Power Gain	25.4dB	24.5dB	8.9dB	22.7dB
Noise Figure	2.1dB	2.3dB	11.8dB	3.3dB
Third-Order Input Intercept	-8.9dBm	-10.6dBm	-6.8dBm	-6.8dBm

**Table 6. Typical Cascaded Performance of PCS-Band Receiver with 3dB Interstage Filter Loss**

PARAMETER	HIGH GAIN, HIGH LINEARITY	HIGH GAIN, LOW LINEARITY	LOW GAIN
Conversion Power Gain	24dB	22.5dB	7.5dB
Noise Figure	2.6dB	3.0dB	12.4dB
Third-Order Input Intercept	-7.6dBm	-9.3dBm	7.1dBm

**Table 7. Cellular LNA S Parameters in High-Gain, High-Linearity Mode**

FREQUENCY (MHz)	S11 (mag)	S11 (phase)	S21 (mag)	S21 (phase)	S12 (mag)	S12 (phase)	S22 (mag)	S22 (phase)
700	0.579	-74.8	4.63	92.1	0.085	60.9	0.714	-34.7
750	0.548	-78.4	4.39	87.9	0.089	60.6	0.696	-35.9
800	0.534	-81.2	4.13	84.4	0.0908	60	0.689	-36.6
850	0.52	-83.7	3.88	81.9	0.096	60.1	0.683	-37.6
900	0.51	-86.1	3.7	79.4	0.099	58.8	0.677	-38.3
950	0.503	-88.5	3.5	76.6	0.104	58.3	0.674	-39.3
1000	0.496	-90.6	3.3	74.9	0.109	59.1	0.669	-40.8

## Adjustable, High-Linearity, SiGe Dual-Band LNA/Mixer ICs

**Table 8. PCS LNA S Parameters in High-Gain, High-Linearity Mode**

FREQUENCY (MHz)	S11 (mag)	S11 (phase)	S21 (mag)	S21 (phase)	S12 (mag)	S12 (phase)	S22 (mag)	S22 (phase)
1700	0.46	-112	4.22	86	0.077	77	0.64	-51
1750	0.446	-113	4.07	88	0.082	77	0.64	-52
1800	0.44	-113	4.18	88	0.086	76	0.643	-52
1850	0.439	-113	4.23	84	0.09	77	0.657	-53
1900	0.434	-114	3.9	82	0.093	72	0.68	-55
1950	0.43	-115	3.82	84	0.09	75	0.673	-57
2000	0.423	-116	3.85	83	0.094	76	0.681	-58
2050	0.407	-115	3.82	83	0.098	76	0.69	-59
2100	0.391	-112	3.82	81	0.103	74	0.7	-61
2150	0.405	-106	3.68	79	0.101	71	0.695	-63
2200	0.467	-104	3.56	81	0.093	73	0.677	-64
2250	0.503	-107	3.67	82	0.094	79	0.683	-63
2300	0.525	-110	3.83	81	0.099	82	0.705	-64
2350	0.54	-112	3.88	78	0.1	86	0.727	-66
2400	0.55	-113	3.9	75	0.106	93	0.739	-67
2450	0.571	-113	3.79	73	0.126	99	0.754	-69
2500	0.614	-113	3.78	74	0.158	100	0.769	-71

**Table 9. Cellular Mixer S11 in High-Gain,  
High-Linearity Mode**

FREQUENCY (MHz)	S11 (mag)	S11 (phase)
700	0.853	-35.8
750	0.849	-38
800	0.846	-40.2
850	0.844	-42.2
900	0.843	-44.1
950	0.842	-46.3
1000	0.842	-48.5

# Adjustable, High-Linearity, SiGe Dual-Band LNA/Mixer ICs

MAX2320/21/22/24/26/27

**Table 10. PCS Mixer S11 in High-Gain High-Linearity Mode**

FREQUENCY (MHz)	S11 (mag)	S11 (phase)
1700	0.865	-62
1750	0.864	-63
1800	0.865	-64
1850	0.867	-64
1900	0.863	-65
1950	0.862	-65
2000	0.861	-66
2050	0.879	-67
2100	0.86	-68
2150	0.858	-68
2200	0.854	-69
2250	0.85	-71
2300	0.845	-72
2350	0.838	-74
2400	0.83	-76
2450	0.825	-78
2500	0.805	-82

**Table 11. Mixer IF Port S22**

FREQUENCY (MHz)	DIGITAL MIXER		FREQUENCY (MHz)	FM MIXER	
	S22 (mag)	S22 (phase)		S22 (mag)	S22 (phase)
50	0.999	-1.10	50	0.999	-1.69
100	0.999	-2.26	70	0.998	-2.38
110	0.999	-2.46	85	0.998	-2.92
130	0.998	-2.89	100	0.997	-3.38
150	0.998	-3.35	110	0.997	-3.71
200	0.998	-4.45	150	0.996	-4.97
210	0.998	-4.67	200	0.995	-6.49
250	0.997	-5.48	250	0.995	-7.82
300	0.997	-6.48	300	0.994	-9.06
350	0.996	-7.47	350	0.993	-10.28
400	0.996	-8.36	400	0.992	-11.40

# Adjustable, High-Linearity, SiGe Dual-Band LNA/Mixer ICs

MAX2320/21/22/24/26/27

## Typical Application Circuits

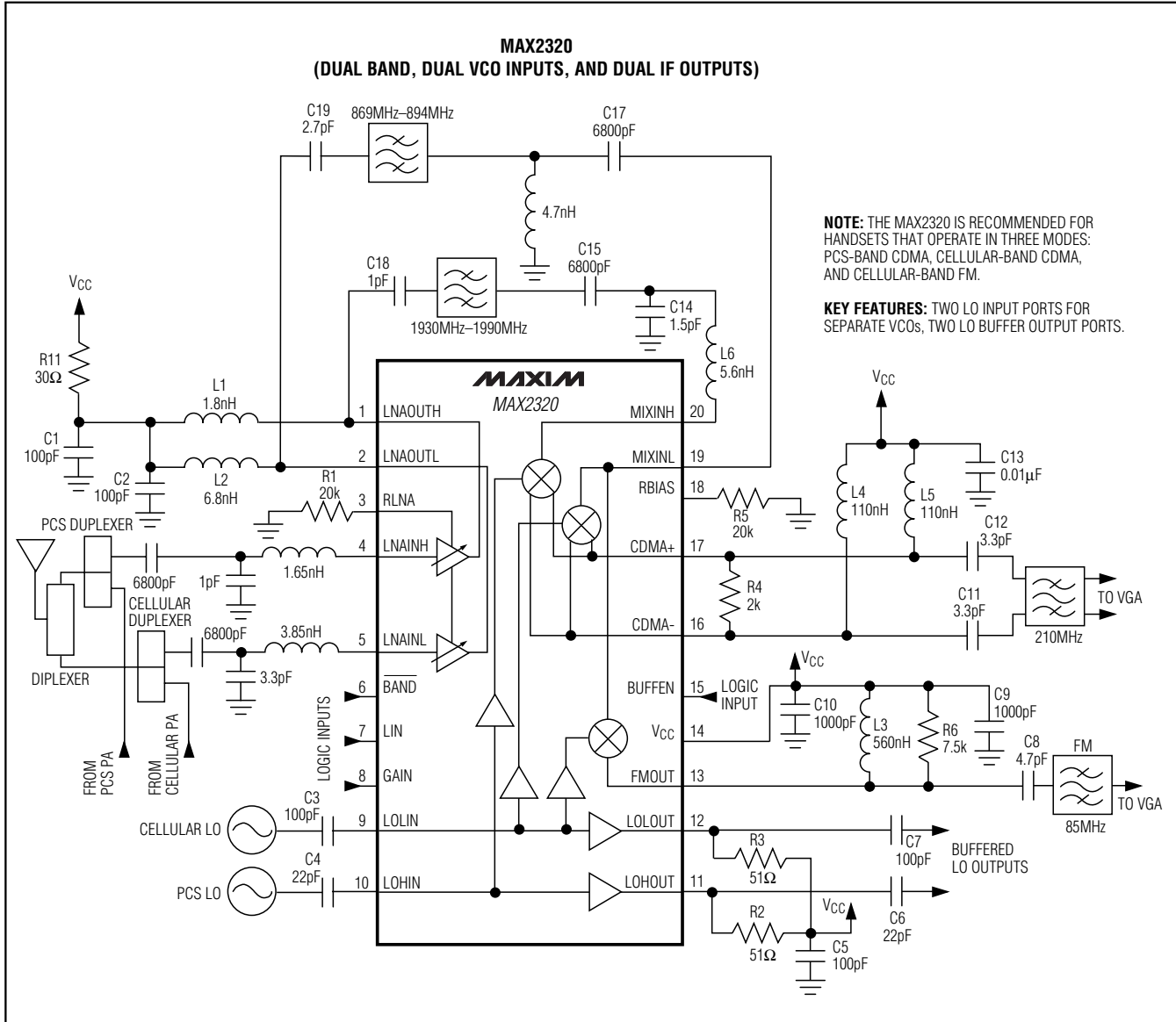

# Adjustable, High-Linearity, SiGe Dual-Band LNA/Mixer ICs

## Typical Application Circuits (continued)

MAX2320/21/22/24/26/27

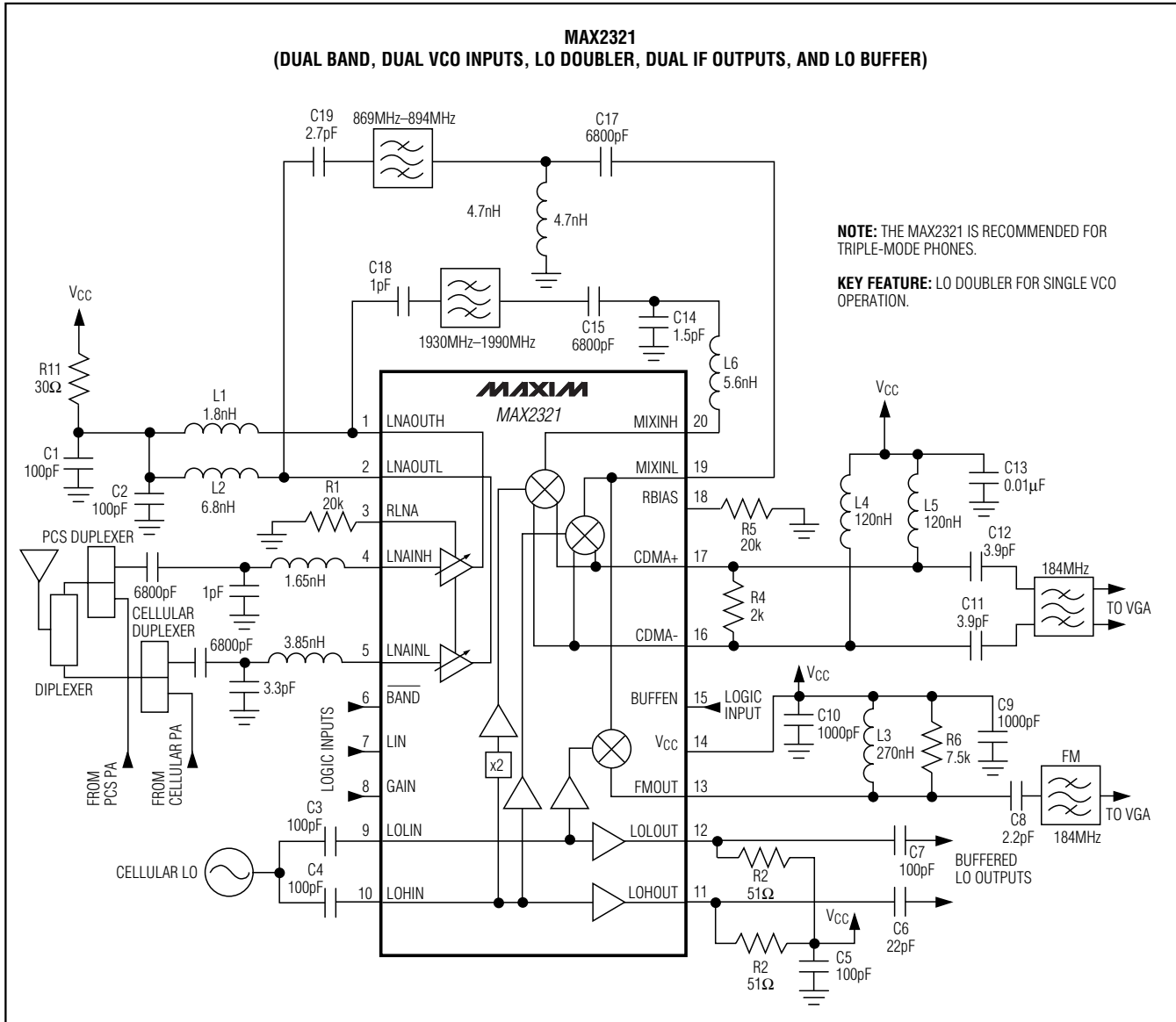

# Adjustable, High-Linearity, SiGe Dual-Band LNA/Mixer ICs

## Typical Application Circuits (continued)

MAX2320/21/22/24/26/27

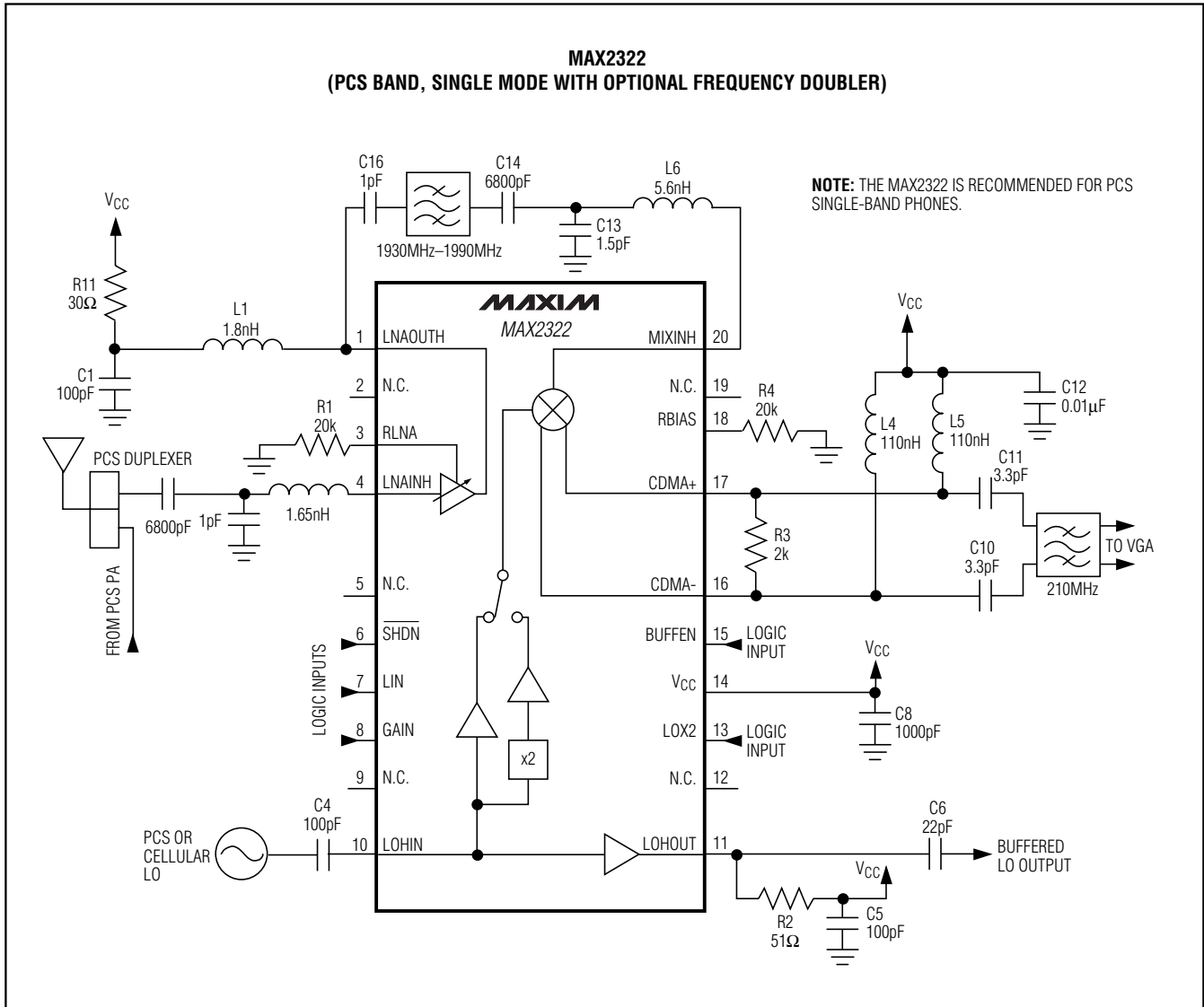

# Adjustable, High-Linearity, SiGe Dual-Band LNA/Mixer ICs

## Typical Application Circuits (continued)

MAX2320/21/22/24/26/27

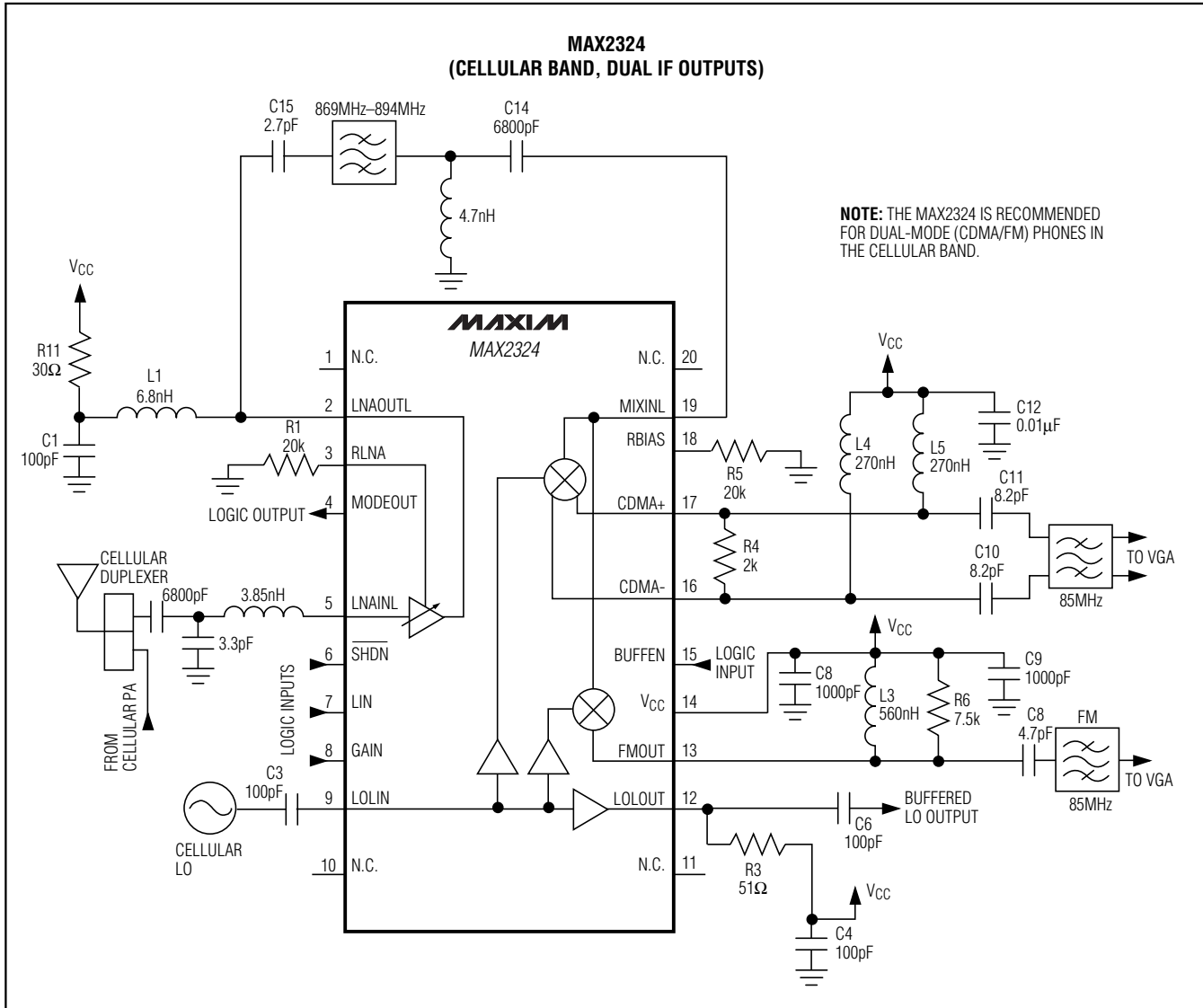

# Adjustable, High-Linearity, SiGe Dual-Band LNA/Mixer ICs

MAX2320/21/22/24/26/27

## Typical Application Circuits (continued)

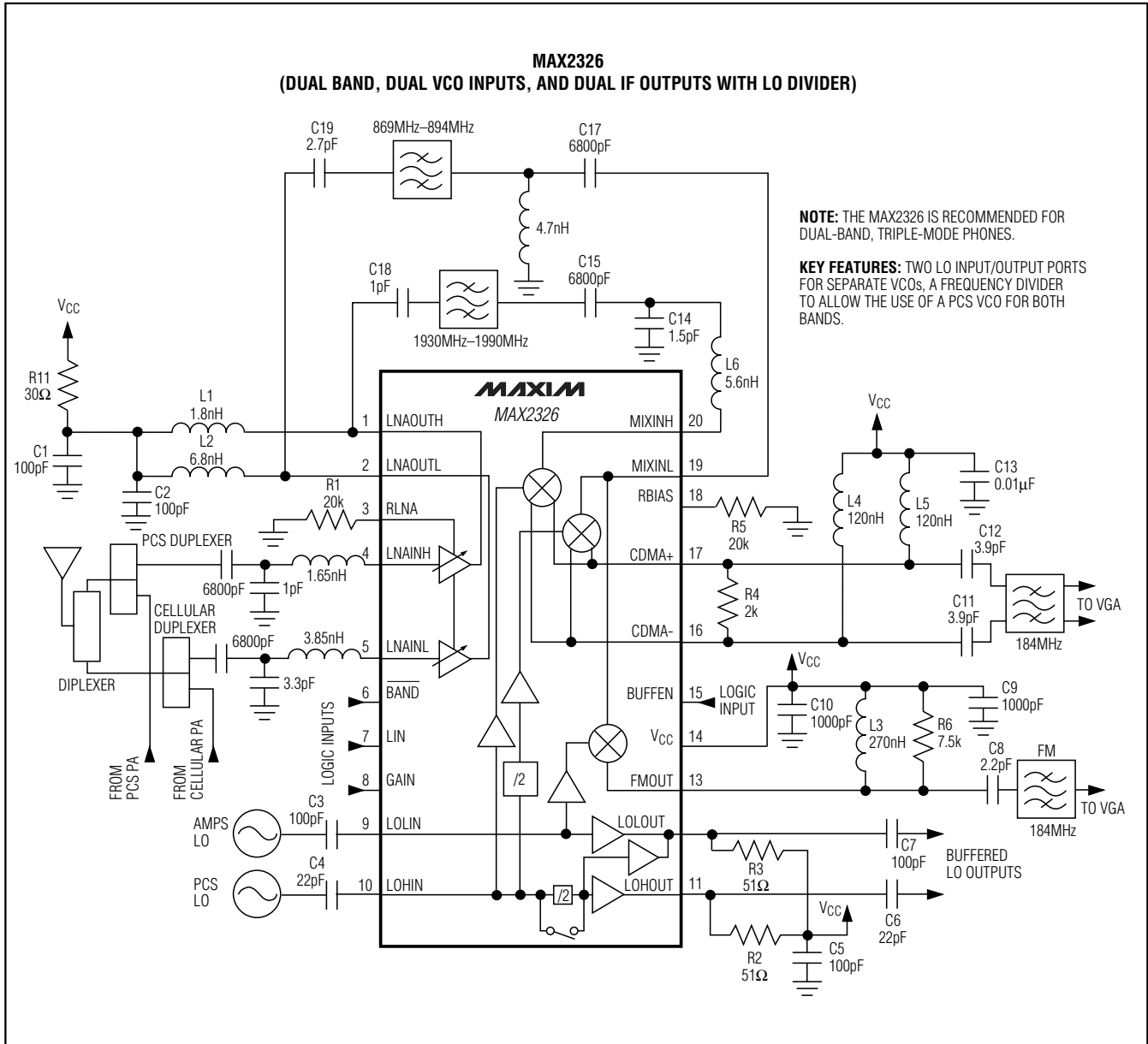



# Adjustable, High-Linearity, SiGe Dual-Band LNA/Mixer ICs

## Typical Application Circuits (continued)

MAX2320/21/22/24/26/27

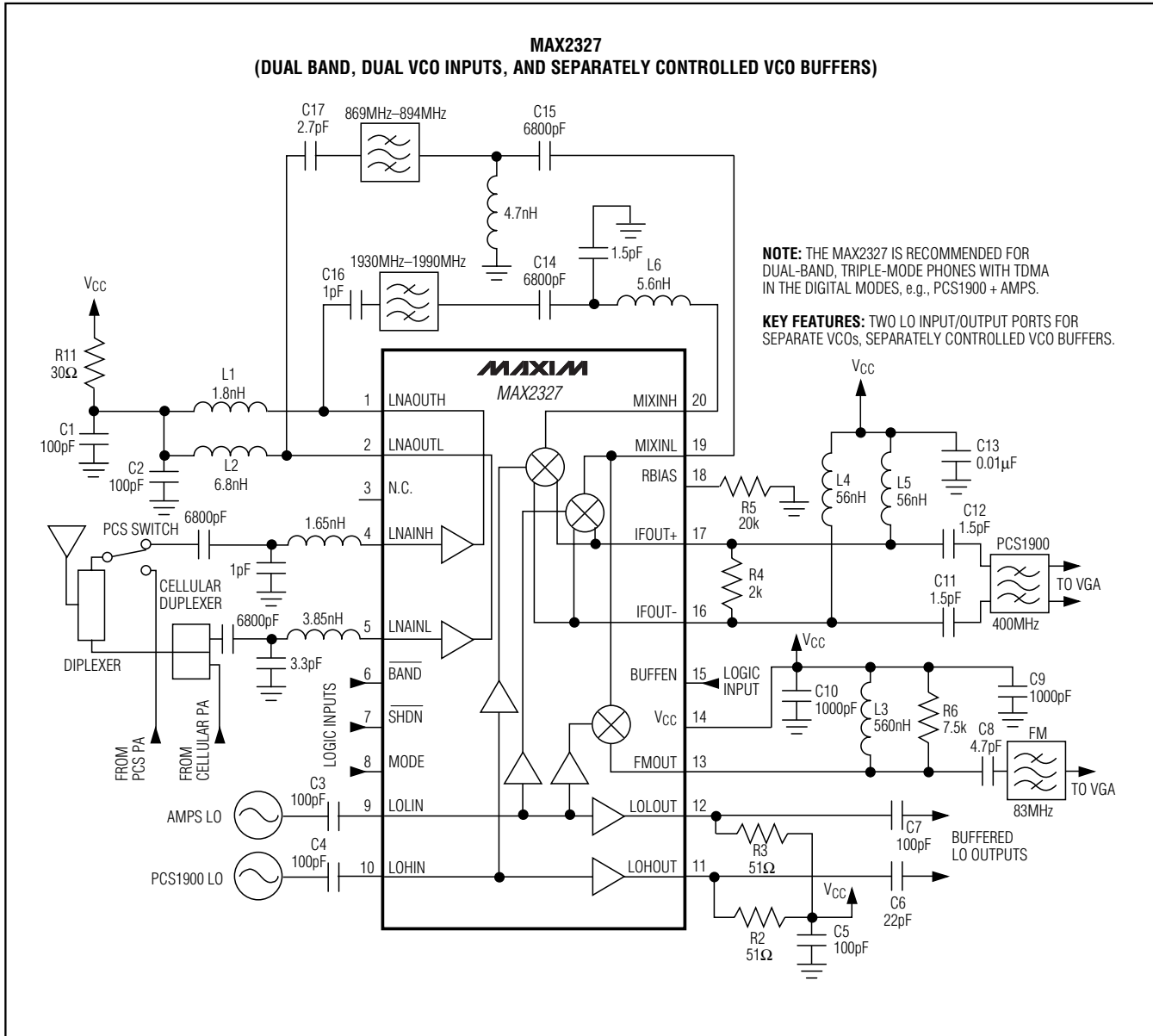

# Adjustable, High-Linearity, SiGe Dual-Band LNA/Mixer ICs

## Pin Configurations (continued)

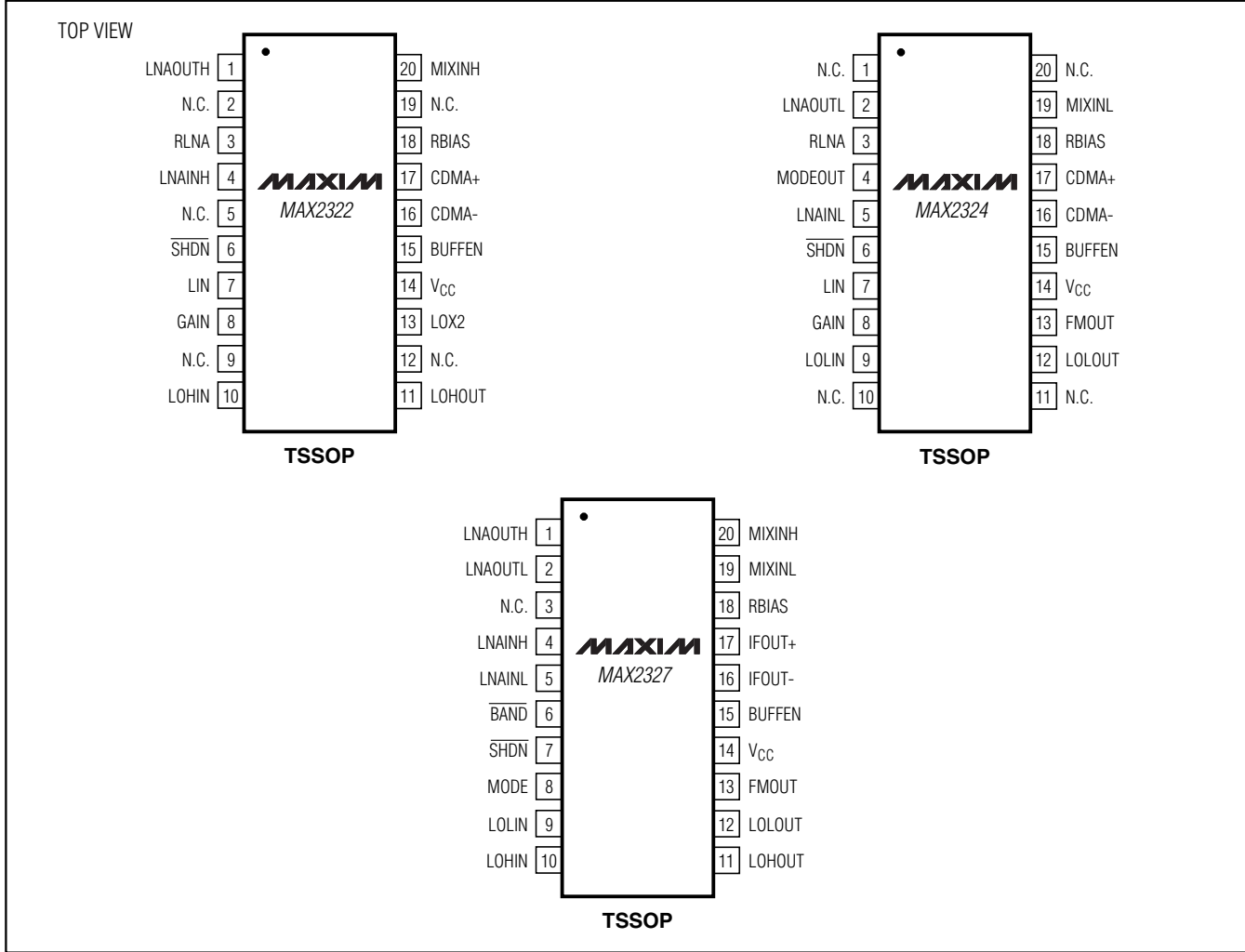

### Ordering Information (continued)

PART	TEMP RANGE	PIN-PACKAGE
MAX2322EUP	-40°C to +85°C	20 TSSOP-EP*
MAX2322EUP+	-40°C to +85°C	20 TSSOP-EP*
MAX2324EUP	-40°C to +85°C	20 TSSOP-EP*
MAX2324EUP+	-40°C to +85°C	20 TSSOP-EP*
MAX2326EUP	-40°C to +85°C	20 TSSOP-EP*
MAX2326EUP+	-40°C to +85°C	20 TSSOP-EP*
MAX2327EUP	-40°C to +85°C	20 TSSOP-EP*
MAX2327EUP+	-40°C to +85°C	20 TSSOP-EP*

+Indicates lead-free package.

\*EP = Exposed pad.

### Chip Information

TRANSISTOR COUNT: 1315

# Adjustable, High-Linearity, SiGe Dual-Band LNA/Mixer ICs

## Package Information

(The package drawing(s) in this data sheet may not reflect the most current specifications. For the latest package outline information go to [www.maxim-ic.com/packages](http://www.maxim-ic.com/packages).)

MAX2320/21/22/24/26/27

SYMBOL	COMMON DIMENSIONS			
	MILLIMETERS		INCHES	
	MIN.	MAX.	MIN.	MAX.
A	—	1.10	—	.043
A <sub>1</sub>	0.05	0.15	.002	.006
A <sub>e</sub>	0.85	0.95	.033	.037
k	0.19	0.30	.007	.012
k <sub>1</sub>	0.19	0.25	.007	.010
c	0.09	0.20	.004	.008
c <sub>1</sub>	0.09	0.14	.004	.006
D	SEE VARIATIONS		SEE VARIATIONS	
E	4.30	4.50	.169	.177
e	0.65 BSC		.026 BSC	
H	6.25	6.55	.246	.258
L	0.50	0.70	.020	.028
N	SEE VARIATIONS		SEE VARIATIONS	
α	0°	8°	0°	8°

JEDEC	N	VARIATIONS			
		MILLIMETERS		INCHES	
		MIN.	MAX.	MIN.	MAX.
AB-1	14	4.90	5.10	.193	.201
AB	16	4.90	5.10	.193	.201
AC	20	6.40	6.60	.252	.260
AD	24	7.70	7.90	.303	.311
AE	28	9.60	9.80	.378	.386

**NOTES:**  
 1. DIMENSIONS D AND E DO NOT INCLUDE FLASH  
 2. MOLD FLASH OR PROTRUSIONS NOT TO EXCEED 0.15mm PER SIDE  
 3. CONTROLLING DIMENSION: MILLIMETER  
 4. MEETS JEDEC OUTLINE MD-153. SEE JEDEC VARIATIONS TABLE  
 5. "N" REFERS TO NUMBER OF LEADS  
 6. THE LEAD TIPS MUST LIE WITHIN A SPECIFIED ZONE. THIS TOLERANCE ZONE IS DEFINED BY TWO PARALLEL PLANES. ONE PLANE IS THE SEATING PLANE, DATUM [-C-]; THE OTHER PLANE IS AT THE SPECIFIED DISTANCE FROM [-C-] IN THE DIRECTION INDICATED

-DRAWING NOT TO SCALE-

TITLED	
PACKAGE OUTLINE, TSSOP 4.40mm BODY	
APPROVAL	DOCUMENT CONTROL NO.
	21-0066
REV.	G
	1/1

TSSOP4.40mm:EPS

Maxim cannot assume responsibility for use of any circuitry other than circuitry entirely embodied in a Maxim product. No circuit patent licenses are implied. Maxim reserves the right to change the circuitry and specifications without notice at any time.

Maxim Integrated Products, 120 San Gabriel Drive, Sunnyvale, CA 94086 408-737-7600 \_\_\_\_\_ 27