

1.5KE6.8(C)A - 1.5KE440(C)A

Features

- Glass passivated junction.
- 1500W Peak Pulse Power capability at 1.0 ms.
- Excellent clamping capability.
- Low incremental surge resistance.
- Fast response time; typically less than 1.0 ps from 0 volts to BV for unidirectional and 5.0 ns for bidirectional.
- Typical I_R less than 1.0 μ A above 10V.
- UL certified, UL #E210467.

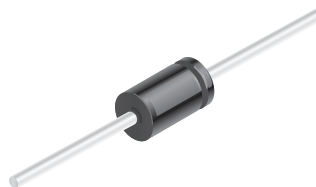

DO-201AE

COLOR BAND DENOTES CATHODE ON UNIDIRECTIONAL DEVICES ONLY. NO COLOR BAND ON BIDIRECTIONAL DEVICES.

DEVICES FOR BIPOLAR APPLICATIONS

- Bidirectional types use CA suffix.
- Electrical Characteristics apply in both directions.

1500 Watt Transient Voltage Suppressors

Absolute Maximum Ratings* $T_A = 25^\circ\text{C}$ unless otherwise noted

Symbol	Parameter	Value	Units
P_{PPM}	Peak Pulse Power Dissipation at $T_A = 25^\circ\text{C}$, $T_P=1\text{ms}$	minimum 1500	W
I_{PPM}	Peak Pulse Current	see table	A
P_D	Steady State Power Dissipation .375" lead length @ $T_A = 75^\circ\text{C}$	5.0	W
I_{FSM}	Non-repetitive Peak Forward Surge Current superimposed on rated load (JEDEC method) (Note 1)	200	A
T_{stg}	Storage Temperature Range	-65 to +175	$^\circ\text{C}$
T_J	Operating Junction Temperature	-65 to +175	$^\circ\text{C}$

*These ratings are limiting values above which the serviceability of any semiconductor device may be impaired.

Note 1: Measured on 8.3 ms single half-sine wave; Duty cycle = 4 pulses per minute maximum.

Datasheet.Directory

Transient Voltage Suppressors

(continued)

Electrical Characteristics

T_A = 25°C unless otherwise noted

Uni-directional Bi-directional (C) Device	Reverse Stand-off Voltage V _{RWM} (V)	Breakdown Voltage V _{BR} (V)		Test Current I _T (mA)	Max Clamping Voltage @ IPPM V _C (V)	Max Peak Pulse Surge Current I _{PPM} (A)	Max Reverse Leakage V _{RWM} I _R (uA)*
		min	max				
1.5KE6.8(C)A	5.80	6.45	7.14	10	10.5	143	1000
1.5KE7.5(C)A	6.40	7.13	7.88	10	11.3	133	500
1.5KE8.2(C)A	7.02	7.79	8.61	10	12.1	124	200
1.5KE9.1(C)A	7.78	8.65	9.55	1	13.4	112	50
1.5KE10(C)A	8.55	9.50	10.5	1	14.5	103	10
1.5KE11(C)A	9.40	10.5	11.6	1	15.6	96.2	5
1.5KE12(C)A	10.2	11.4	12.6	1	16.7	90.0	5
1.5KE13(C)A	11.1	12.4	13.7	1	18.2	82.0	5
1.5KE15(C)A	12.8	14.3	15.8	1	21.2	71.0	5
1.5KE16(C)A	13.6	15.2	16.8	1	22.5	67.0	5
1.5KE18(C)A	15.3	17.1	18.9	1	26.2	59.5	5
1.5KE20(C)A	17.1	19.0	21.0	1	27.7	54.2	5
1.5KE22(C)A	18.8	20.9	23.1	1	30.6	49.0	5
1.5KE24(C)A	20.5	22.8	25.2	1	33.2	45.2	5
1.5KE27(C)A	23.1	25.7	28.4	1	37.5	40.0	5
1.5KE30(C)A	25.6	28.5	31.5	1	41.4	36.2	5
1.5KE33(C)A	28.2	31.4	34.7	1	45.7	33.0	5
1.5KE36(C)A	30.8	34.2	37.8	1	49.9	30.1	5
1.5KE39(C)A	33.3	37.1	41.0	1	53.9	28.0	5
1.5KE43(C)A	36.8	40.9	45.2	1	59.3	25.3	5
1.5KE47(C)A	40.2	44.7	49.4	1	64.8	23.2	5
1.5KE51(C)A	43.6	48.5	53.6	1	70.1	21.4	5
1.5KE56(C)A	47.8	53.2	58.8	1	77.0	19.5	5
1.5KE62(C)A	53.0	58.9	65.1	1	85.0	17.7	5
1.5KE68(C)A	58.1	64.6	71.4	1	92.0	16.3	5
1.5KE75(C)A	64.1	71.3	78.8	1	104.0	14.6	5
1.5KE82(C)A	70.1	77.9	86.1	1	113.0	13.3	5
1.5KE91(C)A	77.8	86.5	95.5	1	125.0	12.0	5
1.5KE100(C)A	85.5	95.0	105.0	1	137.0	11.0	5
1.5KE110(C)A	94.0	106.0	116.0	1	152.0	9.9	5
1.5KE120(C)A	102.0	114.0	126.0	1	165.0	9.1	5
1.5KE130(C)A	111.0	124.0	137.0	1	179.0	8.4	5
1.5KE150(C)A	128.0	143.0	158.0	1	207.0	7.2	5
1.5KE160(C)A	136.0	152.0	168.0	1	219.0	6.8	5
1.5KE170(C)A	145.0	162.0	179.0	1	234.0	6.4	5
1.5KE180(C)A	154.0	171.0	189.0	1	246.0	6.1	5
1.5KE200(C)A	171.0	190.0	210.0	1	274.0	5.5	5
1.5KE220(C)A	185.0	209.0	231.0	1	328.0	4.6	5
1.5KE250(C)A	214.0	237.0	263.0	1	344.0	4.5	5
1.5KE300(C)A	256.0	285.0	315.0	1	414.0	3.8	5
1.5KE350(C)A	300.0	333.0	368.0	1	482.0	3.2	5
1.5KE400(C)A	342.0	380.0	420.0	1	548.0	2.8	5
1.5KE440(C)A	376.0	418.0	462.0	1	602.0	2.6	5

* For bidirectional parts with V_{RWM} < 10V, the I_R max limit is doubled.

1.5KE6.8(C)A - 1.5KE440(C)A

Typical Characteristics

Peak Pulse Power Rating Curve

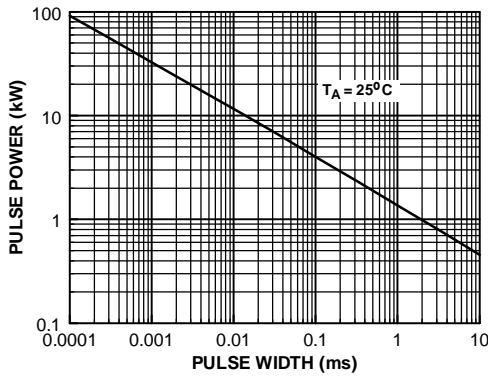

Pulse Derating Curve

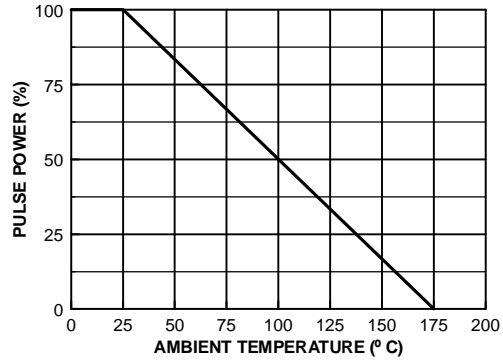

Pulse Waveform

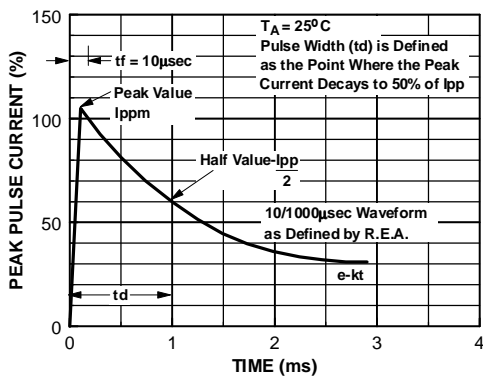

Junction Capacitance

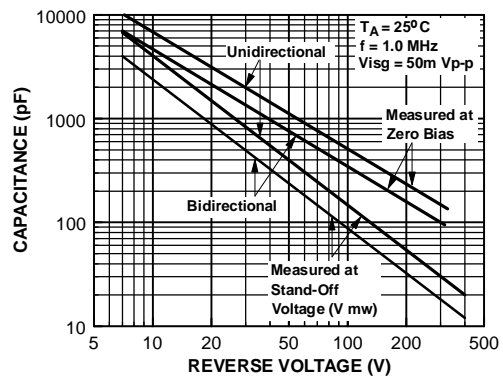

Steady State Power Derating Curve

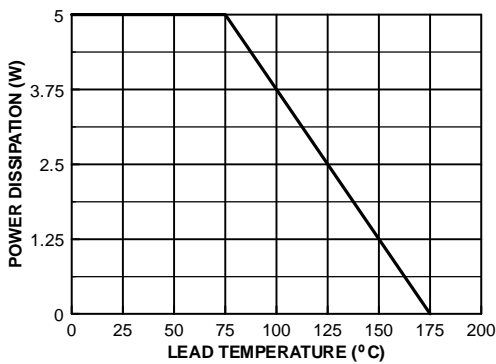

Non-Repetitive Surge Current

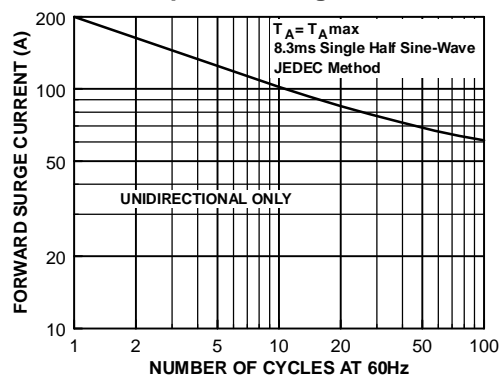

DO-201AD/AE Tape and Reel Data



DO-201AD/AE Packaging Configuration: Figure 1.0

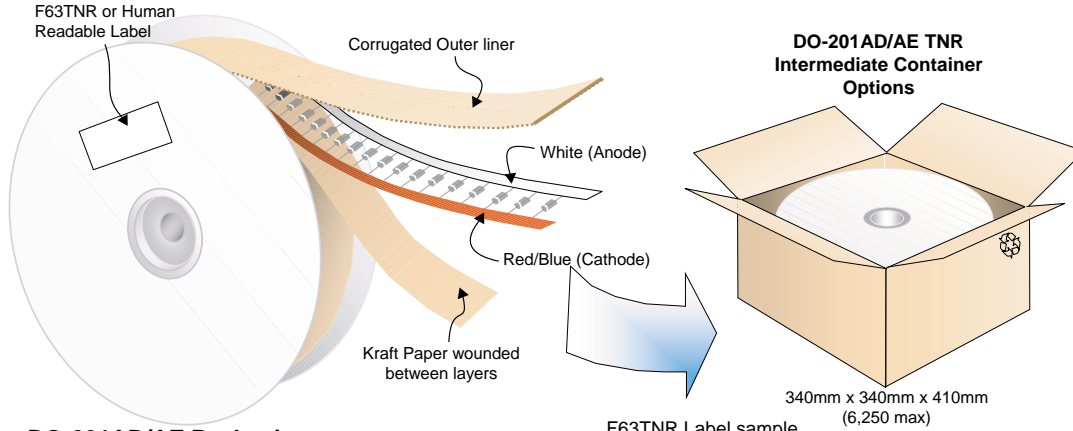

DO-201AD/AE Packaging Information Table : Figure 2.0

DO-201AD/AE Packaging Information	
Packaging Option	Under package code P3
Packaging type	TNR
Qty per Reel/Tube/Bag	1250
Reel Size (inch diameter)	13
Inside Tape Spacing (mm)	52
Int Box Dimension (mm)	340x340x410
Max qty per Box	6,250
Weight per unit (gm)	1.20 AD/1.10 AE
Weight per Reel (kg)	1.50 AD/1.20 AE
Note/Comments	

F63TNR Label sample

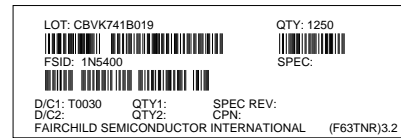

Human Readable Label sample



DO-201AD/AE Taping Dimension: Figure 5.0

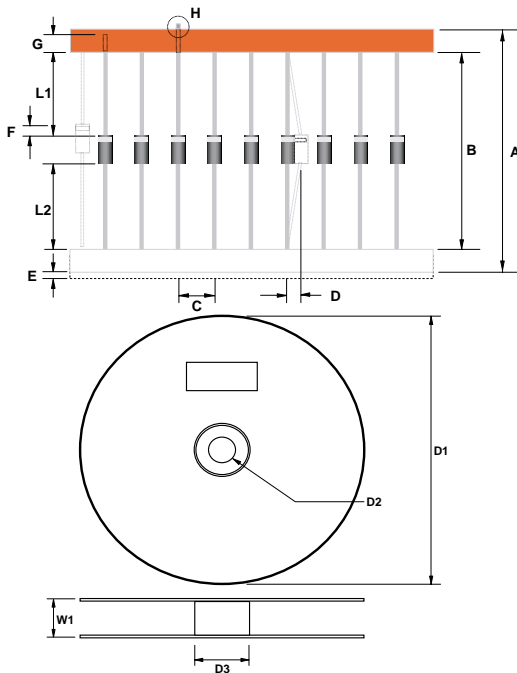

TAPING DIMENSIONS

	INCH	MM	MILS	NOTES
A	2.520	64.00	2519	Overall width
	+0.066/	+1.69/	+66.5/	
	-0.027	-0.69	-27.0	
	1.496	38.00	1496	
	+0.059/	+1.5	+59	
	-0.039	-1.0	-39	
B	2.047±0.027	52 ±0.69	2047±27	Inside Tape Spacing
C	0.200 ±0.0157	10.08 ±0.40	394 ±15.7	Component Pitch
D	0.047(max)	1.2(max)	47(max)	Component Misalignment
E	0.022(max)	0.55(max)	22(max)	Tape Mismatch
F	0.027(max)	±0.69	±27	Units in line w/ one another
G	0.126(min)	3.2(min)	126(min)	Lead amount between tapes
H	0	0	0	Lead amount beyond tapes
L1-L2	±0.027	±0.69	±27	Delta between two leads

REEL DIMENSIONS

ITEM DESCRIPTION	SYMBOL	MINIMUM	MAXIMUM
Reel Diameter	D1	13.875	14.125
Arbor Hole Diameter (Standard)	D2	1.245	1.255
Core Diameter	D3	3.190	3.310
Flange to Flange Outer Width	W1		3.400

Note: All Dimensions are in inches

DO-201AD Package Dimensions



DO-201AD (FS PKG Code P3)

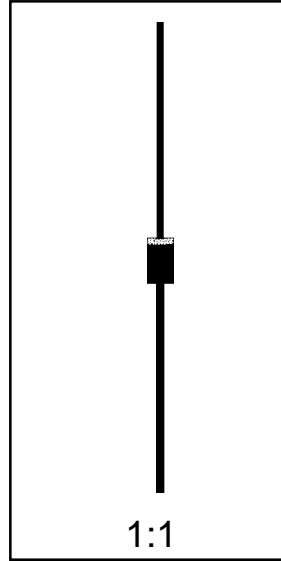

Scale 1:1 on letter size paper

Dimensions shown below are in:
inches [millimeters]

Part Weight per unit (gram): 1.1

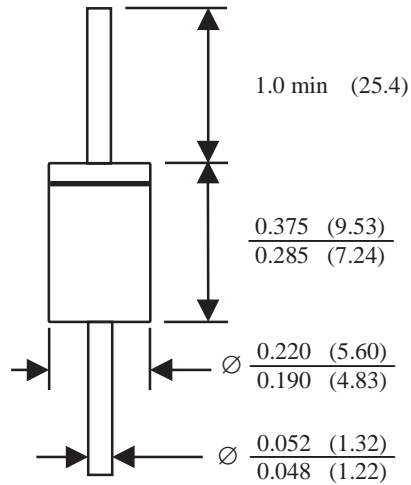

TRADEMARKS

The following are registered and unregistered trademarks Fairchild Semiconductor owns or is authorized to use and is not intended to be an exhaustive list of all such trademarks.

ACEx™	FASTr™	PowerTrench®	SyncFET™
Bottomless™	GlobalOptoisolator™	QFET™	TinyLogic™
CoolFET™	GTO™	QS™	UHC™
CROSSVOLT™	HiSeC™	QT Optoelectronics™	VCX™
DOME™	ISOPLANAR™	Quiet Series™	
E ² CMOS™	MICROWIRE™	SILENT SWITCHER®	
EnSigna™	OPTOLOGIC™	SMART START™	
FACT™	OPTOPLANAR™	SuperSOT™-3	
FACT Quiet Series™	PACMAN™	SuperSOT™-6	
FAST®	POP™	SuperSOT™-8	

DISCLAIMER

FAIRCHILD SEMICONDUCTOR RESERVES THE RIGHT TO MAKE CHANGES WITHOUT FURTHER NOTICE TO ANY PRODUCTS HEREIN TO IMPROVE RELIABILITY, FUNCTION OR DESIGN. FAIRCHILD DOES NOT ASSUME ANY LIABILITY ARISING OUT OF THE APPLICATION OR USE OF ANY PRODUCT OR CIRCUIT DESCRIBED HEREIN; NEITHER DOES IT CONVEY ANY LICENSE UNDER ITS PATENT RIGHTS, NOR THE RIGHTS OF OTHERS.

LIFE SUPPORT POLICY

FAIRCHILD'S PRODUCTS ARE NOT AUTHORIZED FOR USE AS CRITICAL COMPONENTS IN LIFE SUPPORT DEVICES OR SYSTEMS WITHOUT THE EXPRESS WRITTEN APPROVAL OF FAIRCHILD SEMICONDUCTOR CORPORATION. As used herein:

1. Life support devices or systems are devices or systems which, (a) are intended for surgical implant into the body, or (b) support or sustain life, or (c) whose failure to perform when properly used in accordance with instructions for use provided in the labeling, can be reasonably expected to result in significant injury to the user.
2. A critical component is any component of a life support device or system whose failure to perform can be reasonably expected to cause the failure of the life support device or system, or to affect its safety or effectiveness.

PRODUCT STATUS DEFINITIONS

Definition of Terms

Datasheet Identification	Product Status	Definition
Advance Information	Formative or In Design	This datasheet contains the design specifications for product development. Specifications may change in any manner without notice.
Preliminary	First Production	This datasheet contains preliminary data, and supplementary data will be published at a later date. Fairchild Semiconductor reserves the right to make changes at any time without notice in order to improve design.
No Identification Needed	Full Production	This datasheet contains final specifications. Fairchild Semiconductor reserves the right to make changes at any time without notice in order to improve design.
Obsolete	Not In Production	This datasheet contains specifications on a product that has been discontinued by Fairchild semiconductor. The datasheet is printed for reference information only.