



## Surface Mount TRANSZORB<sup>®</sup> Transient Voltage Suppressors



DO-214AB (SMC)

| PRIMARY CHARACTERISTICS                 |                |
|---|----------------|
| V <sub>BR</sub> uni-directional         | 6.8 V to 540 V |
| V <sub>BR</sub> bi-directional          | 6.8 V to 220 V |
| P <sub>PPM</sub>                        | 1500 W         |
| P <sub>D</sub>                          | 6.5 W          |
| I <sub>FSM</sub> (uni-directional only) | 200 A          |
| T <sub>J</sub> max.                     | 150 °C         |

### DEVICES FOR BI-DIRECTION APPLICATIONS

For bi-directional devices use CA suffix (e.g. 1.5SMC220CA).  
Electrical characteristics apply in both directions.

### FEATURES

- Low profile package
- Ideal for automated placement
- Glass passivated chip junction
- Available in uni-directional and bi-directional
- 1500 W peak pulse power capability with a 10/1000  $\mu$ s waveform, repetitive rate (duty cycle): 0.01 %
- Excellent clamping capability
- Very fast response time
- Low incremental surge resistance
- Meets MSL level 1, per J-STD-020, LF maximum peak of 260 °C
- Compliant to RoHS Directive 2002/95/EC and in accordance to WEEE 2002/96/EC
- Halogen-free according to IEC 61249-2-21 definition



**RoHS**  
COMPLIANT  
HALOGEN  
**FREE**

### TYPICAL APPLICATIONS

Use in sensitive electronics protection against voltage transients induced by inductive load switching and lighting on ICs, MOSFET, signal lines of sensor units for consumer, computer, industrial, and telecommunication.

### MECHANICAL DATA

**Case:** DO-214AB (SMC)

Molding compound meets UL 94 V-0 flammability rating  
Base P/N-M3 - halogen-free, RoHS compliant, and commercial grade

**Terminals:** Matte tin plated leads, solderable per J-STD-002 and JESD22-B102  
M3 suffix meets JESD 201 class 1A whisker test

**Polarity:** For uni-directional types the band denotes cathode end, no marking on bi-directional types

| MAXIMUM RATINGS (T <sub>A</sub> = 25 °C, unless otherwise noted)             |                                    |                |      |
|--|------------------------------------|----------------|------|
| PARAMETER  | SYMBOL                             | VALUE          | UNIT |
| Peak power dissipation with a 10/1000 $\mu$ s waveform (fig. 1)              | P <sub>PPM</sub> <sup>(1)(2)</sup> | 1500           | W    |
| Peak pulse current with a 10/1000 $\mu$ s waveform (fig. 3)                  | I <sub>PPM</sub> <sup>(1)</sup>    | See next table | A    |
| Power dissipation on infinite heatsink T <sub>A</sub> = 50 °C                | P <sub>D</sub>                     | 6.5            | W    |
| Peak forward surge current 8.3 ms single half sine-wave uni-directional only | I <sub>FSM</sub> <sup>(2)</sup>    | 200            | A    |
| Operating junction and storage temperature range                             | T <sub>J</sub> , T <sub>STG</sub>  | - 65 to + 150  | °C   |

#### Notes

- (1) Non-repetitive current pulse, per fig. 3 and derated above T<sub>A</sub> = 25 °C per fig. 2  
(2) Mounted on 0.31" x 0.31" (8.0 mm x 8.0 mm) copper pads to each terminal

## 1.5SMC Series

Vishay General Semiconductor



| ELECTRICAL CHARACTERISTICS (T <sub>A</sub> = 25 °C unless otherwise noted) |                     |      |  |      |                                  |                                       |   |  |   |   |
|--|---------------------|------|--|------|----------------------------------|---------------------------------------|---|--|---|---|
| DEVICE TYPE  | DEVICE MARKING CODE |      | BREAKDOWN VOLTAGE V <sub>BR</sub> AT I <sub>T</sub> (V) <sup>(1)</sup> |      | TEST CURRENT I <sub>T</sub> (mA) | STAND-OFF VOLTAGE V <sub>WM</sub> (V) | MAXIMUM REVERSE LEAKAGE AT V <sub>WM</sub> I <sub>D</sub> (μA) <sup>(4)</sup> | MAXIMUM PEAK PULSE CURRENT I <sub>PPM</sub> (A) <sup>(2)</sup> | MAXIMUM CLAMPING VOLTAGE AT I <sub>PPM</sub> V <sub>C</sub> (V) | MAXIMUM TEMPERATURE COEFFICIENT OF V <sub>BR</sub> (%/°C) |
|  | UNI                 | BI   | MIN.   | MAX. |                                  |                                       |   |  |   |   |
| 1.5SMC6.8A   | 6V8A                | 6V8C | 6.45   | 7.14 | 10                               | 5.80                                  | 1000  | 143  | 10.5  | 0.057   |
| 1.5SMC7.5A   | 7V5A                | 7V5C | 7.13   | 7.88 | 10                               | 6.40                                  | 500   | 133  | 11.3  | 0.061   |
| 1.5SMC8.2A   | 8V2A                | 8V2C | 7.79   | 8.61 | 10                               | 7.02                                  | 200   | 124  | 12.1  | 0.065   |
| 1.5SMC9.1A   | 9V1A                | 9V1C | 8.65   | 9.55 | 1.0                              | 7.78                                  | 50  | 112  | 13.4  | 0.068   |
| 1.5SMC10A  | 10A                 | 10C  | 9.50   | 10.5 | 1.0                              | 8.55                                  | 10  | 103  | 14.5  | 0.073   |
| 1.5SMC11A  | 11A                 | 11C  | 10.5   | 11.6 | 1.0                              | 9.40                                  | 5.0   | 96.2   | 15.6  | 0.075   |
| 1.5SMC12A  | 12A                 | 12C  | 11.4   | 12.6 | 1.0                              | 10.2                                  | 5.0   | 89.8   | 16.7  | 0.078   |
| 1.5SMC13A  | 13A                 | 13C  | 12.4   | 13.7 | 1.0                              | 11.1                                  | 5.0   | 82.4   | 18.2  | 0.081   |
| 1.5SMC15A  | 15A                 | 15C  | 14.3   | 15.8 | 1.0                              | 12.8                                  | 1.0   | 70.8   | 21.2  | 0.084   |
| 1.5SMC16A  | 16A                 | 16C  | 15.2   | 16.8 | 1.0                              | 13.6                                  | 1.0   | 66.7   | 22.5  | 0.086   |
| 1.5SMC18A  | 18A                 | 18C  | 17.1   | 18.9 | 1.0                              | 15.3                                  | 1.0   | 59.5   | 25.2  | 0.089   |
| 1.5SMC20A  | 20A                 | 20C  | 19.0   | 21.0 | 1.0                              | 17.1                                  | 1.0   | 54.2   | 27.7  | 0.090   |
| 1.5SMC22A  | 22A                 | 22C  | 20.9   | 23.1 | 1.0                              | 18.8                                  | 1.0   | 49.0   | 30.6  | 0.092   |
| 1.5SMC24A  | 24A                 | 24C  | 22.8   | 25.2 | 1.0                              | 20.5                                  | 1.0   | 45.2   | 33.2  | 0.09  |
| 1.5SMC27A  | 27A                 | 27C  | 25.7   | 28.4 | 1.0                              | 23.1                                  | 1.0   | 40.0   | 37.5  | 0.096   |
| 1.5SMC30A  | 30A                 | 30C  | 28.5   | 31.5 | 1.0                              | 25.6                                  | 1.0   | 36.2   | 41.4  | 0.097   |
| 1.5SMC33A  | 33A                 | 33C  | 31.4   | 34.7 | 1.0                              | 28.2                                  | 1.0   | 32.8   | 45.7  | 0.098   |
| 1.5SMC36A  | 36A                 | 36C  | 34.2   | 37.8 | 1.0                              | 30.8                                  | 1.0   | 30.1   | 49.9  | 0.099   |
| 1.5SMC39A  | 39A                 | 39C  | 37.1   | 41.0 | 1.0                              | 33.3                                  | 1.0   | 27.8   | 53.9  | 0.100   |
| 1.5SMC43A  | 43A                 | 43C  | 40.9   | 45.2 | 1.0                              | 36.8                                  | 1.0   | 25.3   | 59.3  | 0.101   |
| 1.5SMC47A  | 47A                 | 47C  | 44.7   | 49.4 | 1.0                              | 40.2                                  | 1.0   | 23.1   | 64.8  | 0.101   |
| 1.5SMC51A  | 51A                 | 51C  | 48.5   | 53.6 | 1.0                              | 43.6                                  | 1.0   | 21.4   | 70.1  | 0.102   |
| 1.5SMC56A  | 56A                 | 56C  | 53.2   | 58.8 | 1.0                              | 47.8                                  | 1.0   | 19.5   | 77.0  | 0.103   |
| 1.5SMC62A  | 62A                 | 62C  | 58.9   | 65.1 | 1.0                              | 53.0                                  | 1.0   | 17.6   | 85.0  | 0.104   |
| 1.5SMC68A  | 68A                 | 68C  | 64.6   | 71.4 | 1.0                              | 58.1                                  | 1.0   | 16.3   | 92.0  | 0.104   |
| 1.5SMC75A  | 75A                 | 75C  | 71.3   | 78.8 | 1.0                              | 64.1                                  | 1.0   | 14.6   | 104   | 0.105   |
| 1.5SMC82A  | 82A                 | 82C  | 77.9   | 86.1 | 1.0                              | 70.1                                  | 1.0   | 13.3   | 113   | 0.105   |
| 1.5SMC91A  | 91A                 | 91C  | 86.5   | 95.5 | 1.0                              | 77.8                                  | 1.0   | 12.0   | 125   | 0.106   |
| 1.5SMC100A   | 100A                | 100C | 95.0   | 105  | 1.0                              | 85.5                                  | 1.0   | 10.9   | 137   | 0.106   |
| 1.5SMC110A   | 110A                | 110C | 105  | 116  | 1.0                              | 94.0                                  | 1.0   | 9.9  | 152   | 0.107   |
| 1.5SMC120A   | 120A                | 120C | 114  | 126  | 1.0                              | 102                                   | 1.0   | 9.1  | 165   | 0.107   |
| 1.5SMC130A   | 130A                | 130C | 124  | 137  | 1.0                              | 111                                   | 1.0   | 8.4  | 179   | 0.107   |
| 1.5SMC150A   | 150A                | 150C | 143  | 158  | 1.0                              | 128                                   | 1.0   | 7.2  | 207   | 0.106   |
| 1.5SMC160A   | 160A                | 160C | 152  | 168  | 1.0                              | 136                                   | 1.0   | 6.8  | 219   | 0.108   |
| 1.5SMC170A   | 170A                | 170C | 162  | 179  | 1.0                              | 145                                   | 1.0   | 6.4  | 234   | 0.108   |
| 1.5SMC180A   | 180A                | 180C | 171  | 189  | 1.0                              | 154                                   | 1.0   | 6.1  | 246   | 0.108   |
| 1.5SMC200A   | 200A                | 200C | 190  | 210  | 1.0                              | 171                                   | 1.0   | 5.5  | 274   | 0.108   |
| 1.5SMC220A   | 220A                | 220C | 209  | 231  | 1.0                              | 185                                   | 1.0   | 4.6  | 328   | 0.108   |
| 1.5SMC250A   | 250A                | -    | 237  | 263  | 1.0                              | 214                                   | 1.0   | 4.4  | 344   | 0.110   |
| 1.5SMC300A   | 300A                | -    | 285  | 315  | 1.0                              | 256                                   | 1.0   | 3.6  | 414   | 0.110   |
| 1.5SMC350A   | 350A                | -    | 333  | 368  | 1.0                              | 300                                   | 1.0   | 3.1  | 482   | 0.110   |
| 1.5SMC400A   | 400A                | -    | 380  | 420  | 1.0                              | 342                                   | 1.0   | 2.7  | 548   | 0.110   |
| 1.5SMC440A   | 440A                | -    | 418  | 462  | 1.0                              | 376                                   | 1.0   | 2.5  | 602   | 0.110   |
| 1.5SMC480A   | 480A                | -    | 456  | 504  | 1.0                              | 408                                   | 1.0   | 2.28   | 658   | 0.110   |
| 1.5SMC510A   | 510A                | -    | 485  | 535  | 1.0                              | 434                                   | 1.0   | 2.15   | 698   | 0.110   |
| 1.5SMC540A   | 540A                | -    | 513  | 567  | 1.0                              | 459                                   | 1.0   | 2.03   | 740   | 0.110   |

## Notes

- (1) Pulse test: t<sub>p</sub> ≤ 50 ms  
(2) Surge current waveform per fig. 3 and derate per fig. 2  
(3) All terms and symbols are consistent with ANSI/IEEE CA62.35  
(4) For bi-directional types with V<sub>R</sub> 10 V and less, the I<sub>D</sub> limit is doubled  
(5) V<sub>F</sub> = 3.5 V at I<sub>F</sub> = 100 A (uni-directional only)



| THERMAL CHARACTERISTICS ( $T_A = 25\text{ }^\circ\text{C}$ unless otherwise noted) |                       |       |                    |
|--|-----------------------|-------|--------------------|
| PARAMETER  | SYMBOL                | VALUE | UNIT               |
| Typical thermal resistance, junction to ambient air                                | $R_{\theta JA}^{(1)}$ | 75    | $^\circ\text{C/W}$ |
| Typical thermal resistance, junction to lead                                       | $R_{\theta JL}$       | 15    | $^\circ\text{C/W}$ |

**Note**

(1) Mounted on minimum recommended pad layout

| ORDERING INFORMATION (Example) |                 |                        |               |                                    |
|--------------------------------|-----------------|------------------------|---------------|------------------------------------|
| PREFERRED P/N                  | UNIT WEIGHT (g) | PREFERRED PACKAGE CODE | BASE QUANTITY | DELIVERY MODE                      |
| 1.5SMC6.8A-M3/57T              | 0.211           | 57T                    | 850           | 7" diameter plastic tape and reel  |
| 1.5SMC6.8A-M3/9AT              | 0.211           | 9AT                    | 3500          | 13" diameter plastic tape and reel |

**RATINGS AND CHARACTERISTICS CURVES**

( $T_A = 25\text{ }^\circ\text{C}$  unless otherwise noted)

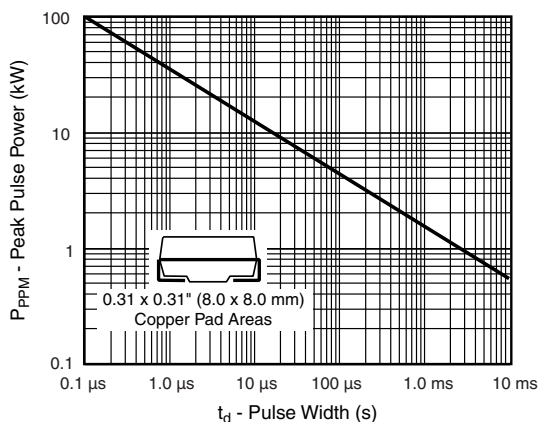

Fig. 1 - Peak Pulse Power Rating Curve

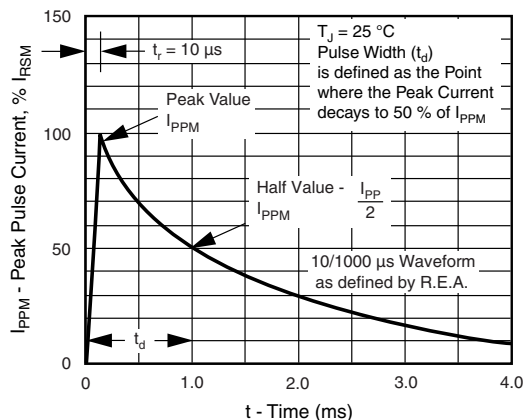

Fig. 3 - Pulse Waveform

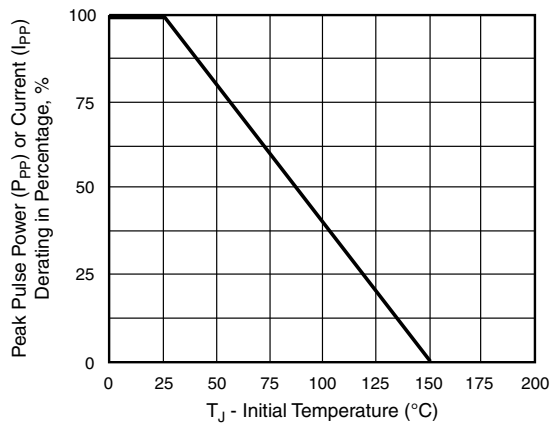

Fig. 2 - Pulse Power or Current vs. Initial Junction Temperature

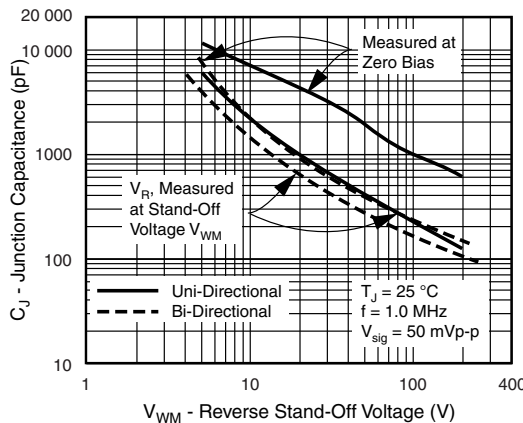

Fig. 4 - Typical Junction Capacitance Uni-Directional

# 1.5SMC Series

Vishay General Semiconductor

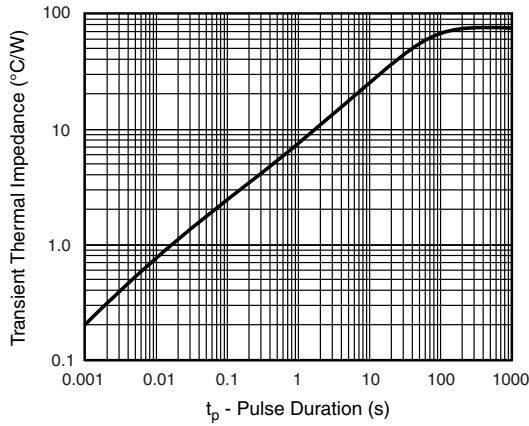

Fig. 5 - Typical Transient Thermal Impedance

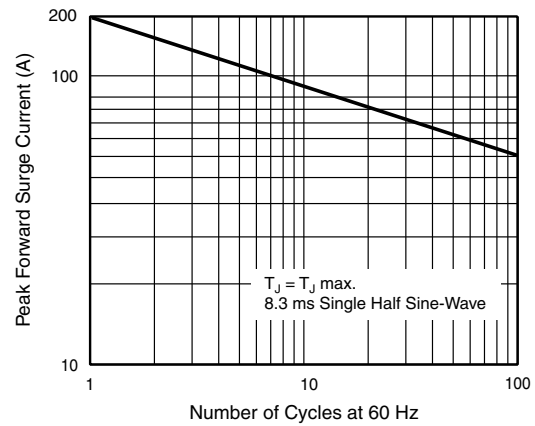
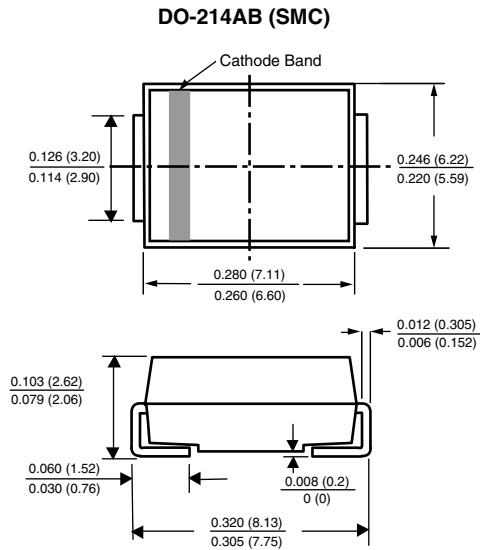
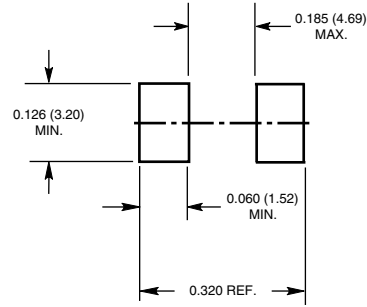

Fig. 6 - Maximum Non-Repetitive Forward Surge Current  
Uni-Directional Use Only

## PACKAGE OUTLINE DIMENSIONS in inches (millimeters)



## Mounting Pad Layout





## Disclaimer

ALL PRODUCT, PRODUCT SPECIFICATIONS AND DATA ARE SUBJECT TO CHANGE WITHOUT NOTICE TO IMPROVE RELIABILITY, FUNCTION OR DESIGN OR OTHERWISE.

Vishay Intertechnology, Inc., its affiliates, agents, and employees, and all persons acting on its or their behalf (collectively, "Vishay"), disclaim any and all liability for any errors, inaccuracies or incompleteness contained in any datasheet or in any other disclosure relating to any product.

Vishay makes no warranty, representation or guarantee regarding the suitability of the products for any particular purpose or the continuing production of any product. To the maximum extent permitted by applicable law, Vishay disclaims (i) any and all liability arising out of the application or use of any product, (ii) any and all liability, including without limitation special, consequential or incidental damages, and (iii) any and all implied warranties, including warranties of fitness for particular purpose, non-infringement and merchantability.

Statements regarding the suitability of products for certain types of applications are based on Vishay's knowledge of typical requirements that are often placed on Vishay products in generic applications. Such statements are not binding statements about the suitability of products for a particular application. It is the customer's responsibility to validate that a particular product with the properties described in the product specification is suitable for use in a particular application. Parameters provided in datasheets and/or specifications may vary in different applications and performance may vary over time. All operating parameters, including typical parameters, must be validated for each customer application by the customer's technical experts. Product specifications do not expand or otherwise modify Vishay's terms and conditions of purchase, including but not limited to the warranty expressed therein.

Except as expressly indicated in writing, Vishay products are not designed for use in medical, life-saving, or life-sustaining applications or for any other application in which the failure of the Vishay product could result in personal injury or death. Customers using or selling Vishay products not expressly indicated for use in such applications do so at their own risk and agree to fully indemnify and hold Vishay and its distributors harmless from and against any and all claims, liabilities, expenses and damages arising or resulting in connection with such use or sale, including attorneys fees, even if such claim alleges that Vishay or its distributor was negligent regarding the design or manufacture of the part. Please contact authorized Vishay personnel to obtain written terms and conditions regarding products designed for such applications.

No license, express or implied, by estoppel or otherwise, to any intellectual property rights is granted by this document or by any conduct of Vishay. Product names and markings noted herein may be trademarks of their respective owners.

## Material Category Policy

**Vishay Intertechnology, Inc. hereby certifies that all its products that are identified as RoHS-Compliant fulfill the definitions and restrictions defined under Directive 2011/65/EU of The European Parliament and of the Council of June 8, 2011 on the restriction of the use of certain hazardous substances in electrical and electronic equipment (EEE) - recast, unless otherwise specified as non-compliant.**

**Please note that some Vishay documentation may still make reference to RoHS Directive 2002/95/EC. We confirm that all the products identified as being compliant to Directive 2002/95/EC conform to Directive 2011/65/EU.**