



LIGHTING FOREVER

## 6 PIN DIP PHOTOTRANSISTOR PHOTOCOUPLER

4N2X Series  
4N3X Series  
H11AX Series

### Features:

- 4N2X series: 4N25, 4N26, 4N27, 4N28
- 4N3X series: 4N35, 4N36, 4N37, 4N38
- H11AX series: H11A1, H11A2, H11A3, H11A4, H11A5
- High isolation voltage between input and output  
(Viso=5000 V rms)
- Creepage distance >7.62 mm
- Operating temperature up to +110°C
- Compact dual-in-line package
- Pb free and RoHS compliant.
- UL approved (No. E214129)
- VDE approved (No. 132249)
- SEMKO approval pending
- NEMKO approval pending
- DEMKO approval pending
- FIMKO approval pending
- CSA approval pending

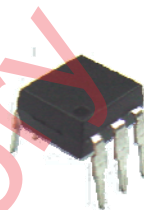

Schematic

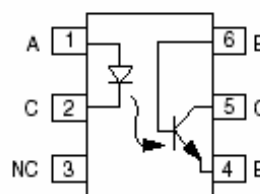

1. Anode
2. Cathode
3. No Connection
4. Emitter
5. Collector
6. Base

### Description

The 4N2X, 4N3X, H11AX series contains an infrared emitting diode optically coupled to a phototransistor. It is packaged in a 6-pin DIP package and available in wide-lead spacing and SMD option.

### Applications

- Power supply regulators
- Digital logic inputs
- Microprocessor inputs



LIGHTING FOREVER

# 6 PIN DIP PHOTOTRANSISTOR PHOTOCOUPLER

**4N2X Series**  
**4N3X Series**  
**H11AX Series**

## Absolute Maximum Ratings ( $T_a=25^{\circ}\text{C}$ )

Parameter		Symbol	Rating	Unit
Input	Forward current	$I_F$	50	mA
	Peak forward current ( $t = 10\mu\text{s}$ )	$I_{FM}$	1	A
	Reverse voltage	$V_R$	6	V
	Power dissipation ( $T_A = 25^{\circ}\text{C}$ )	$P_D$	70	mW
	Derating factor (above $100^{\circ}\text{C}$ )		3.8	mW/ $^{\circ}\text{C}$
Output	Collector-Emitter voltage	$V_{CEO}$	80	V
	Collector-Base voltage	$V_{CBO}$	80	V
	Emitter-Collector voltage	$V_{ECO}$	7	V
	Emitter-Base voltage	$V_{EBO}$	7	V
	Power dissipation ( $T_A = 25^{\circ}\text{C}$ )	$P_C$	150	mW
Derating factor (above $100^{\circ}\text{C}$ )	9.0		mW/ $^{\circ}\text{C}$	
Total power dissipation		$P_{tot}$	200	mW
Isolation voltage <sup>*1</sup>		$V_{iso}$	5000	V <sub>rms</sub>
Operating temperature		$T_{opr}$	-55~+110	$^{\circ}\text{C}$
Storage temperature		$T_{stg}$	-55~+125	$^{\circ}\text{C}$
Soldering temperature <sup>*2</sup>		$T_{sol}$	260	$^{\circ}\text{C}$

### Notes

\*1 AC for 1 minute, R.H.= 40 ~ 60% R.H. In this test, pins 1, 2 & 3 are shorted together, and pins 4, 5 & 6 are shorted together.

\*2 For 10 seconds.



LIGHTING FOREVER

# 6 PIN DIP PHOTOTRANSISTOR PHOTOCOUPLER

4N2X Series  
4N3X Series  
H11AX Series

## Electrical Characteristics ( $T_a=25^{\circ}\text{C}$ unless specified otherwise)

### Input

Parameter	Symbol	Min.	Typ.*	Max.	Unit	Condition
Forward voltage	$V_F$	-	1.2	1.5	V	$I_F = 10\text{mA}$
Reverse current	$I_R$	-	-	10	$\mu\text{A}$	$V_R = 6\text{V}$
Input capacitance	$C_{in}$	-	30	-	pF	$V = 0, f = 1\text{MHz}$

### Output

Parameter	Symbol	Min.	Typ.*	Max.	Unit	Condition
Collector-Base dark current	$I_{CBO}$	-	-	20	nA	$V_{CB} = 10\text{V}$
Collector-Emitter dark current	$I_{CEO}$	-	-	50	nA	$V_{CE} = 10\text{V}, I_F = 0\text{mA}$
		-	-	50		$V_{CE} = 60\text{V}, I_F = 0\text{mA}$
Collector-Emitter breakdown voltage	$BV_{CEO}$	80	-	-	V	$I_C = 1\text{mA}$
Collector-Base breakdown voltage	$BV_{CBO}$	80	-	-	V	$I_C = 0.1\text{mA}$
Emitter-Collector breakdown voltage	$BV_{ECO}$	7	-	-	V	$I_E = 0.1\text{mA}$
Emitter-Base breakdown voltage	$BV_{EBO}$	7	-	-	V	$I_E = 0.1\text{mA}$
Collector-Emitter capacitance	$C_{CE}$	-	8	-	pF	$V_{CE} = 0\text{V}, f = 1\text{MHz}$

\* Typical values at  $T_a = 25^{\circ}\text{C}$



LIGHTING FOREVER

# 6 PIN DIP PHOTOTRANSISTOR PHOTOCOUPLER

**4N2X Series**  
**4N3X Series**  
**H11AX Series**

Transfer Characteristics ( $T_a=25^\circ\text{C}$  unless specified otherwise)

Parameter		Symbol	Min.	Typ.*	Max.	Unit	Condition
Current transfer ratio	4N35, 4N36, 4N37	CTR	100	-	-	%	$I_F = 10\text{mA}, V_{CE} = 10\text{V}$
	H11A1		50	-	-		
	H11A5		30	-	-		
	4N25, 4N26, 4N38, H11A2, H11A3		20	-	-		
	4N27, 4N28, H11A4		10	-	-		
Collector-Emitter saturation voltage	4N25, 4N26, 4N27, 4N28	$V_{CE(sat)}$	-	-	0.5	V	$I_F = 50\text{mA}, I_C = 2\text{mA}$
	4N35, 4N36, 4N37		-	-	0.3		$I_F = 10\text{mA}, I_C = 0.5\text{mA}$
	H11A1, H11A2, H11A3, H11A4, H11A5		-	-	0.4		
	4N38		-	-	1.0		$I_F = 20\text{mA}, I_C = 4\text{mA}$
Isolation resistance		$R_{IO}$	$10^{11}$	-	-	$\Omega$	$V_{IO} = 500\text{Vdc}$
Input-output capacitance		$C_{IO}$	-	0.2	-	pF	$V_{IO} = 0, f = 1\text{MHz}$
Turn-on time	4N25, 4N26, 4N27, 4N28, H11A1, H11A2, H11A3, H11A4, H11A5	Ton	-	3	10	$\mu\text{s}$	$V_{CC} = 10\text{V}, I_F = 10\text{mA}, R_L = 100\Omega$ See Fig. 11
	4N35, 4N36, 4N37, 4N38		-	10	12		$V_{CC} = 10\text{V}, I_C = 2\text{mA}, R_L = 100\Omega$ , See Fig. 11
Turn-off time	4N25, 4N26, 4N27, 4N28, H11A1, H11A2, H11A3, H11A4	Toff	-	3	10	$\mu\text{s}$	$V_{CC} = 10\text{V}, I_F = 10\text{mA}, R_L = 100\Omega$ See Fig. 11
	4N35, 4N36, 4N37, 4N38		-	9	12		$V_{CC} = 10\text{V}, I_C = 2\text{mA}, R_L = 100\Omega$ , See Fig. 11

\* Typical values at  $T_a = 25^\circ\text{C}$

# 6 PIN DIP PHOTOTRANSISTOR PHOTOCOUPLER

**4N2X Series  
4N3X Series  
H11AX Series**

## Typical Performance Curves

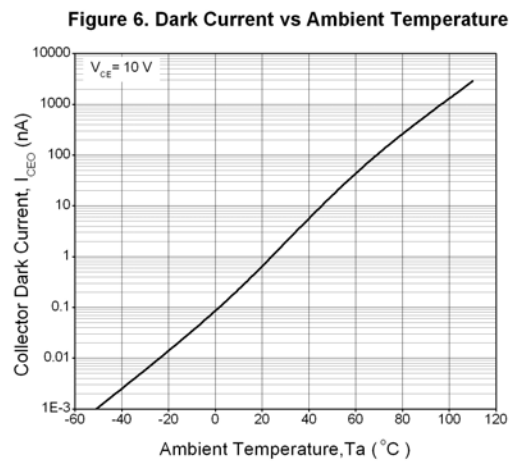
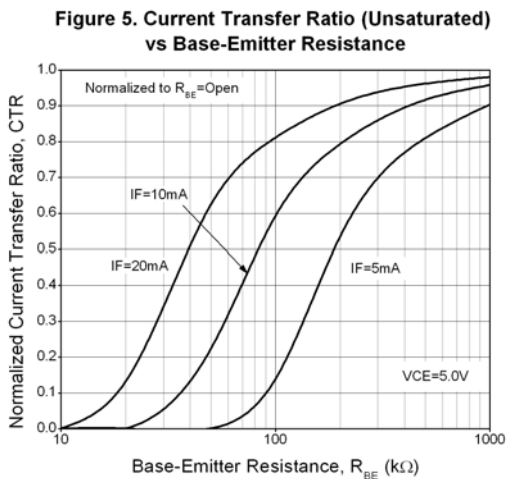
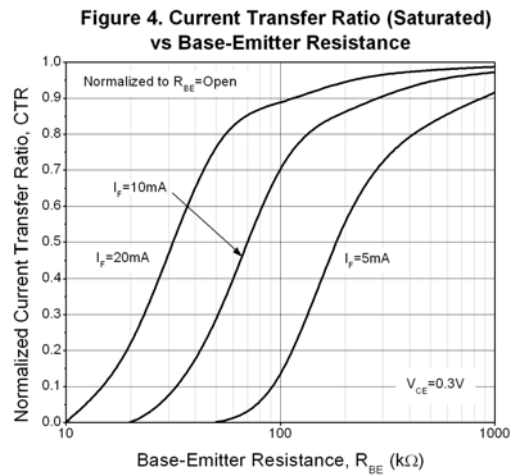
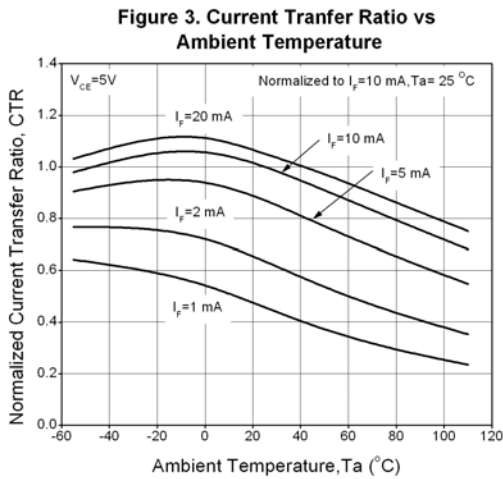
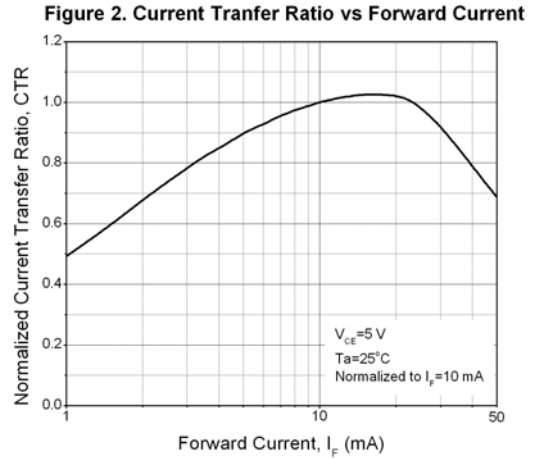
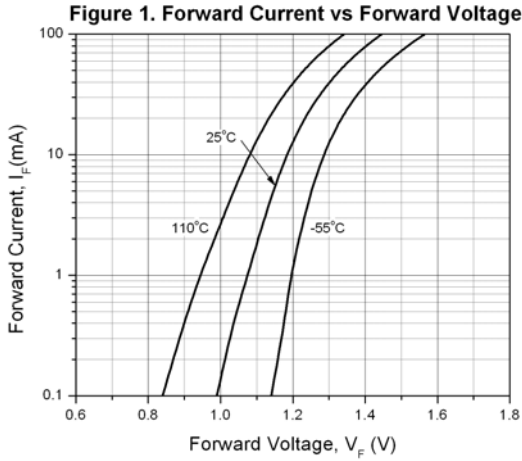

# 6 PIN DIP PHOTOTRANSISTOR PHOTOCOUPLER

**4N2X Series  
4N3X Series  
H11AX Series**

**Figure 7. Collector-Emitter Saturation Voltage vs Collector Current**

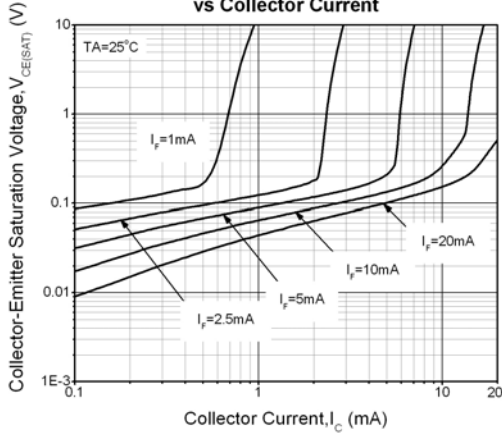

**Figure 8. Switching Time vs Load Resistance**

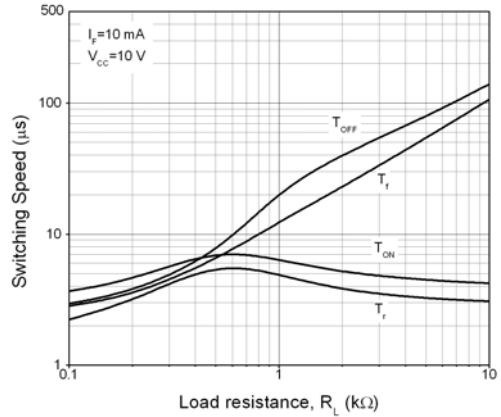

**Figure 9. Turn-on Time vs Base-Emitter Resistance**

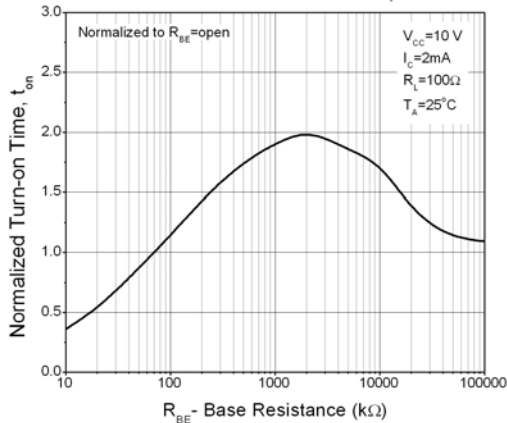

**Figure 10. Turn-off Time vs Base-Emitter Resistance**

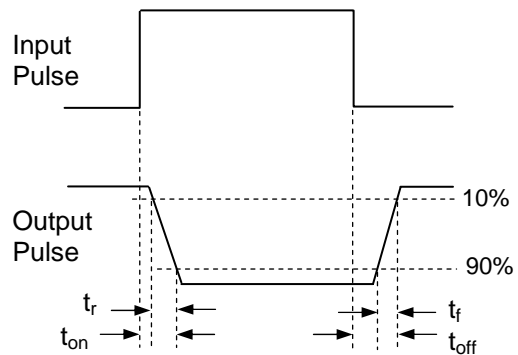
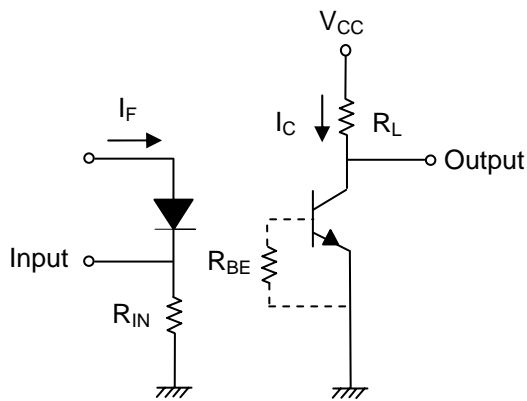
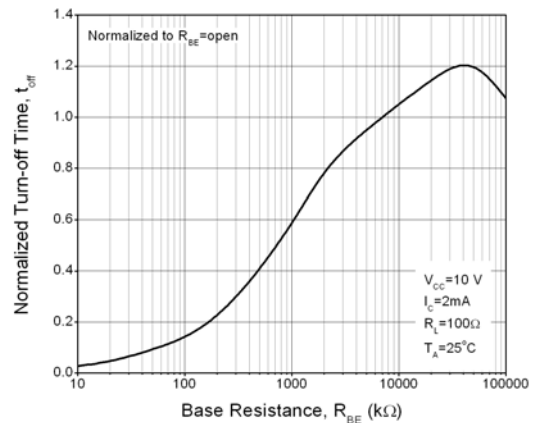

**Figure 11. Switching Time Test Circuit & Waveforms**



LIGHTING FOREVER

# 6 PIN DIP PHOTOTRANSISTOR PHOTOCOUPLER

**4N2X Series**  
**4N3X Series**  
**H11AX Series**

## Order Information

### Part Number

**4NXXY(Z)-V**

or

**H11AXY(Z)-V**

### Note

XX = Part no. for 4NXX series (25, 26, 27, 28, 35, 36, 37 or 38)

X = Part no. for H11AX series (1, 2, 3, 4, or 5)

Y = Lead form option (S, S1, M or none)

Z = Tape and reel option (TA, TB or none).

V = VDE (optional)

Option	Description	Packing quantity
None	Standard DIP-6	65 units per tube
M	Wide lead bend (0.4 inch spacing)	65 units per tube
S (TA)	Surface mount lead form + TA tape & reel option	1000 units per reel
S (TB)	Surface mount lead form + TB tape & reel option	1000 units per reel
S1 (TA)	Surface mount lead form (low profile) + TA tape & reel option	1000 units per reel
S1 (TB)	Surface mount lead form (low profile) + TB tape & reel option	1000 units per reel

**6 PIN DIP PHOTOTRANSISTOR  
PHOTOCOUPLER**

**4N2X Series  
4N3X Series  
H11AX Series**

**Package Drawings  
(Dimensions in mm)**

**Standard DIP Type**

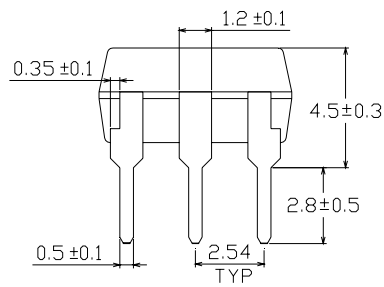
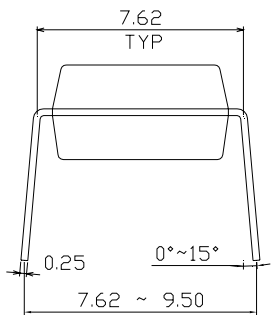
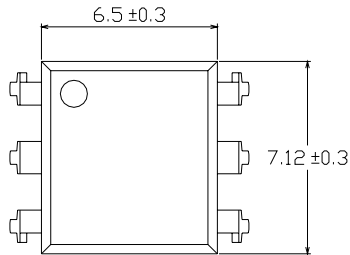

**Option M Type**

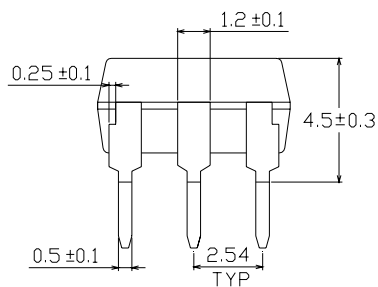
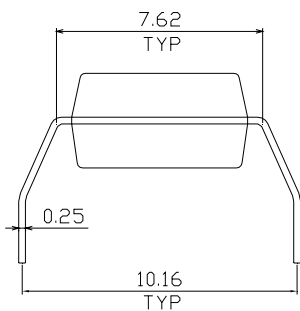
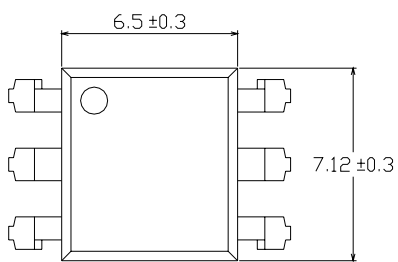



**6 PIN DIP PHOTOTRANSISTOR  
PHOTOCOUPLER**

**4N2X Series  
4N3X Series  
H11AX Series**

**Option S Type**

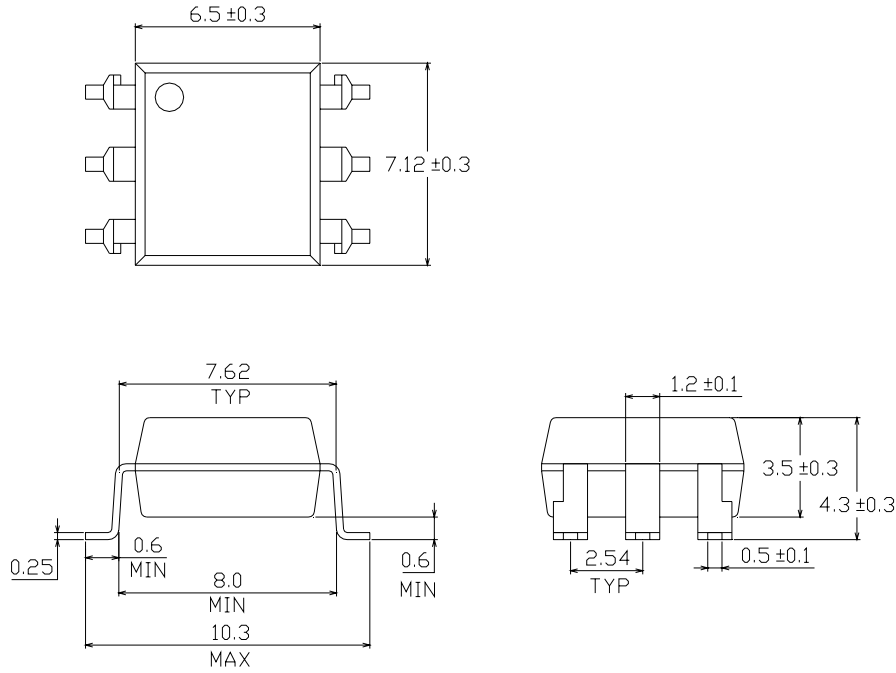

**Option S1 Type**

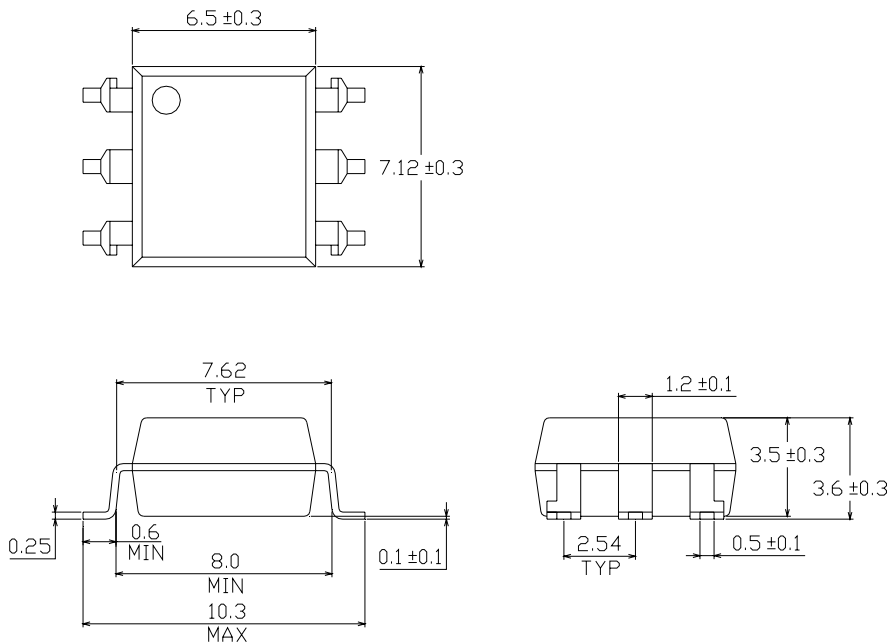

**6 PIN DIP PHOTOTRANSISTOR  
PHOTOCOUPLER**

**4N2X Series  
4N3X Series  
H11AX Series**

Recommended pad layout for surface mount leadfrom

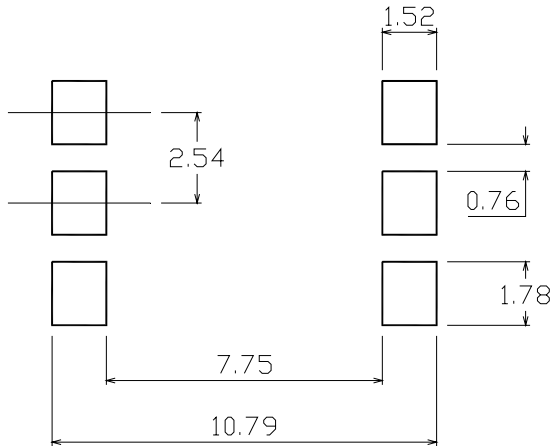

**Device Marking**

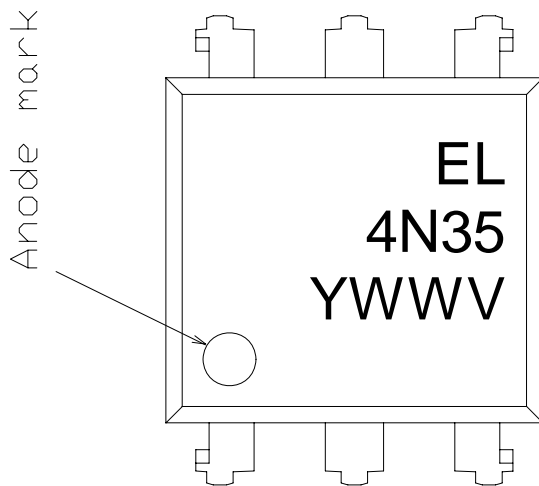

**Notes**

- EL denotes Everlight
- 4N35 denotes Device Number
- Y denotes 1 digit Year code
- WW denotes 2 digit Week code
- V denotes VDE (optional)

**6 PIN DIP PHOTOTRANSISTOR  
PHOTOCOUPLER**

**4N2X Series  
4N3X Series  
H11AX Series**

**Tape & Reel Packing Specifications**

**Option TA**

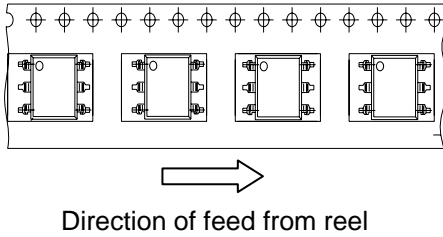

**Option TB**

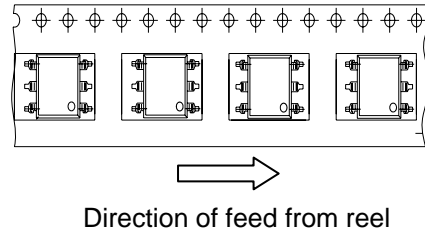

**Tape dimensions**

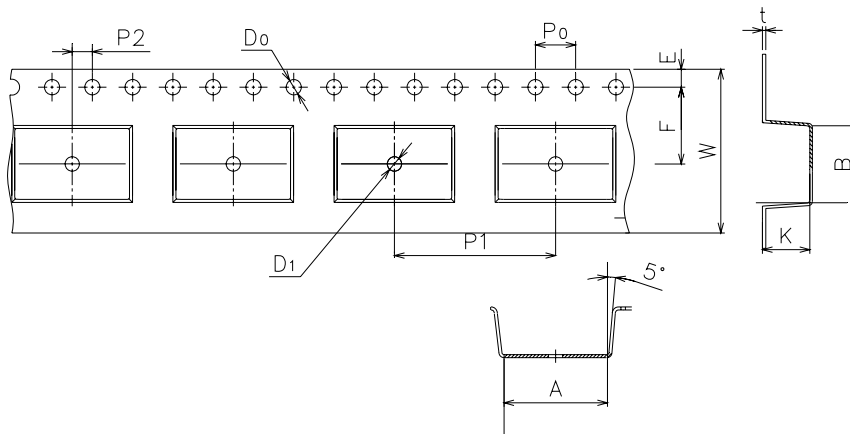

Dimension No.	A	B	D0	D1	E	F
Dimension (mm)	10.4±0.1	7.52±0.1	1.5±0.1	1.5+0.1/-0	1.75±0.1	7.5±0.1

Dimension No.	P0	P1	P2	t	W	K
Dimension (mm)	4.0±0.15	16.0±0.1	2.0±0.1	0.35±0.03	16.0±0.2	4.5±0.1

# 6 PIN DIP PHOTOTRANSISTOR PHOTOCOUPLER

**4N2X Series  
4N3X Series  
H11AX Series**

## Solder Reflow Temperature Profile

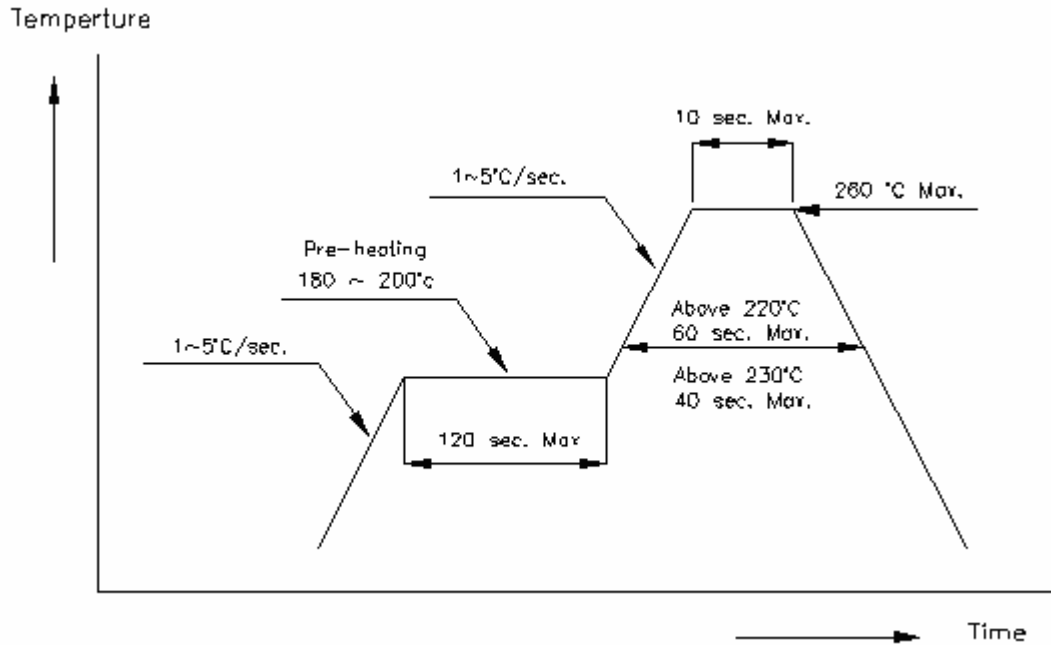



LIGHTING FOREVER

## 6 PIN DIP PHOTOTRANSISTOR PHOTOCOUPLER

**4N2X Series**  
**4N3X Series**  
**H11AX Series**

---

### DISCLAIMER

1. Above specification may be changed without notice. EVERLIGHT will reserve authority on material change for above specification.
2. When using this product, please observe the absolute maximum ratings and the instructions for use as outlined in these specification sheets. EVERLIGHT assumes no responsibility for any damage resulting from use of the product which does not comply with the absolute maximum ratings and the instructions included in these specification sheets.
3. These specification sheets include materials protected under copyright of EVERLIGHT Corporation. Please do not reproduce or cause anyone to reproduce them without EVERLIGHT's consent.