

File Number 1579

IRF720, IRF721, IRF722, IRF723

Power MOS Field-Effect Transistors

N-Channel Enhancement-Mode Power Field-Effect Transistors

2.5A and 3.0A, 350V-400V
 $r_{DS(on)} = 1.8 \Omega$ and 2.5Ω

Features:

- SOA is power-dissipation limited
- Nanosecond switching speeds
- Linear transfer characteristics
- High input impedance
- Majority carrier device

N-CHANNEL ENHANCEMENT MODE

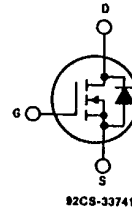

82CS-33741

TERMINAL DIAGRAM

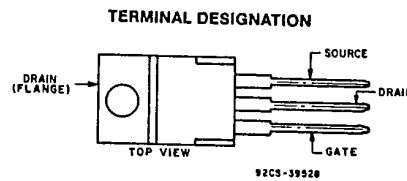

JEDEC TO-220AB

The IRF720, IRF721, IRF722 and IRF723 are n-channel enhancement-mode silicon-gate power field-effect transistors designed for applications such as switching regulators, switching converters, motor drivers, relay drivers, and drivers for high-power bipolar switching transistors requiring high speed and low gate-drive power. These types can be operated directly from integrated circuits.

The IRF-types are supplied in the JEDEC TO-220AB plastic package.

Datasheet.Directory

Absolute Maximum Ratings

Parameter	IRF720	IRF721	IRF722	IRF723	Units
V_{DS} Drain - Source Voltage (1)	400	350	400	350	V
V_{DGB} Drain - Gate Voltage ($R_{GS} = 20 \text{ k}\Omega$) (1)	400	350	400	350	V
$I_D @ T_C = 25^\circ\text{C}$ Continuous Drain Current	3.0	3.0	2.5	2.5	A
$I_D @ T_C = 100^\circ\text{C}$ Continuous Drain Current	2.0	2.0	1.5	1.5	A
I_{DM} Pulsed Drain Current (1)	12	12	10	10	A
V_{GS} Gate - Source Voltage	± 20				V
$P_D @ T_C = 25^\circ\text{C}$ Max. Power Dissipation	40 (See Fig. 14)				W
Linear Derating Factor	0.32 (See Fig. 14)				W/ $^\circ\text{C}$
I_{LM} Inductive Current, Clamped	(See Fig. 15 and 16) $L = 100\mu\text{H}$				A
T_J Operating Junction and Storage Temperature Range	-55 to 150				$^\circ\text{C}$
T_{stg} Lead Temperature	300 (0.063 in. (1.6mm) from case for 10s)				$^\circ\text{C}$

IRF720, IRF721, IRF722, IRF723

Electrical Characteristics @ T_C = 25°C (Unless Otherwise Specified)

Parameter	Type	Min.	Typ.	Max.	Units	Test Conditions
BV _{DSS} Drain-Source Breakdown Voltage	IRF720 IRF722	400	-	-	V	V _{GS} = 0V I _D = 250μA
	IRF721 IRF723	350	-	-	V	
V _{GS(th)} Gate Threshold Voltage	ALL	2.0	-	4.0	V	V _{DS} = V _{GS} , I _D = 250μA
I _{GSS} Gate-Source Leakage Forward	ALL	-	-	500	nA	V _{GS} = 20V
I _{GSS} Gate-Source Leakage Reverse	ALL	-	-	-500	nA	V _{GS} = -20V
I _{DSS} Zero Gate Voltage Drain Current	ALL	-	-	250	μA	V _{DS} = Max. Rating, V _{GS} = 0V
I _{D(on)} On-State Drain Current ②	IRF720 IRF721	3.0	-	-	A	V _{DS} > I _{D(on)} × R _{DS(on)} max., V _{GS} = 10V
	IRF722 IRF723	2.5	-	-	A	
R _{DS(on)} Static Drain-Source On-State Resistance ②	IRF720 IRF721	-	1.5	1.8	Ω	V _{GS} = 10V, I _D = 1.5A
	IRF722 IRF723	-	1.8	2.5	Ω	
g _{fs} Forward Transconductance ②	ALL	1.0	2.0	-	S (Ω)	V _{DS} > I _{D(on)} × R _{DS(on)} max., I _D = 1.5A
C _{iss} Input Capacitance	ALL	-	450	600	pF	V _{GS} = 0V, V _{DS} = 25V, f = 1.0 MHz See Fig. 10
C _{oss} Output Capacitance	ALL	-	100	200	pF	
C _{rss} Reverse Transfer Capacitance	ALL	-	20	40	pF	
t _{d(on)} Turn-On Delay Time	ALL	-	20	40	ns	V _{DD} = 0.5 BV _{DSS} , I _D = 1.5A, Z _θ = 500 See Fig. 17
t _r Rise Time	ALL	-	25	50	ns	
t _{d(off)} Turn-Off Delay Time	ALL	-	50	100	ns	(MOSFET switching times are essentially independent of operating temperature.)
t _f Fall Time	ALL	-	25	50	ns	
Q _g Total Gate Charge (Gate-Source Plus Gate-Drain)	ALL	-	12	15	nC	V _{GS} = 10V, I _D = 4.0A, V _{DS} = 0.8 Max. Rating. See Fig. 18 for test circuit. (Gate charge is essentially independent of operating temperature.)
Q _{gs} Gate-Source Charge	ALL	-	6.0	-	nC	
Q _{gd} Gate-Drain ("Miller") Charge	ALL	-	6.0	-	nC	
L _D Internal Drain Inductance	ALL	-	3.5	-	nH	Measured from the contact screw on tab to center of die.
		-	4.5	-	nH	Measured from the drain lead, 6mm (0.25 in.) from package to center of die.
L _S Internal Source Inductance	ALL	-	7.5	-	nH	Measured from the source lead, 6mm (0.25 in.) from package to source bonding pad.

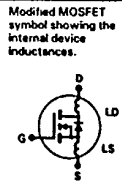

Thermal Resistance

R _{thJC} Junction-to-Case	ALL	-	-	3.12	°C/W
R _{thCS} Case-to-Sink	ALL	-	1.0	-	°C/W
R _{thJA} Junction-to-Ambient	ALL	-	-	80	°C/W

Source-Drain Diode Ratings and Characteristics

I _S Continuous Source Current (Body Diode)	IRF720 IRF721	-	-	3.0	A	Modified MOSFET symbol showing the integral reverse P-N junction rectifier.
	IRF722 IRF723	-	-	2.5	A	
I _{SM} Pulse Source Current (Body Diode) ③	IRF720 IRF721	-	-	12	A	
	IRF722 IRF723	-	-	10	A	
V _{SD} Diode Forward Voltage ④	IRF720 IRF721	-	-	1.6	V	T _C = 25°C, I _S = 3.0A, V _{GS} = 0V
	IRF722 IRF723	-	-	1.5	V	
t _{rr} Reverse Recovery Time	ALL	-	450	-	ns	T _J = 150°C, I _F = 3.0A, dI _F /dt = 100 A/μs
Q _{RR} Reverse Recovered Charge	ALL	-	3.1	-	μC	T _J = 150°C, I _F = 3.0A, dI _F /dt = 100 A/μs
t _{on} Forward Turn-on Time	ALL	-	-	-	-	Intrinsic turn-on time is negligible. Turn on speed is substantially controlled by L _S + L _D .

① T_J = 25°C to 150°C. ② Pulse Test: Pulse width < 300μs, Duty Cycle < 2%. ③ Repetitive Rating. Pulse width limited by max. junction temperature. See Transient Thermal Impedance Curve (Fig. 5).

IRF720, IRF721, IRF722, IRF723

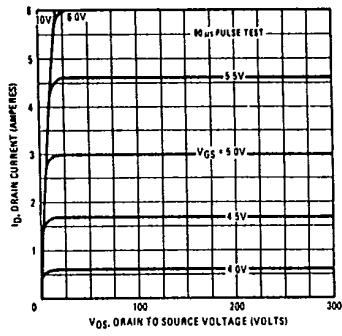

Fig. 1 - Typical Output Characteristics

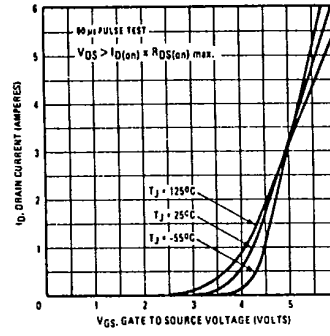

Fig. 2 - Typical Transfer Characteristics

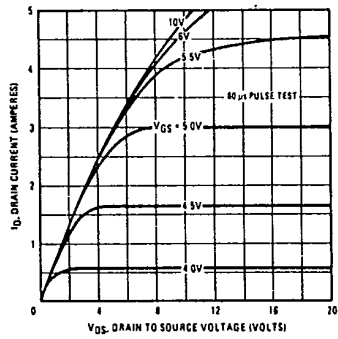

Fig. 3 - Typical Saturation Characteristics

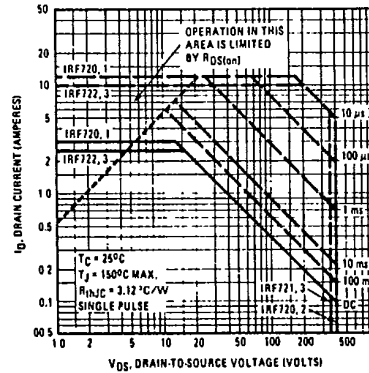

Fig. 4 - Maximum Safe Operating Area

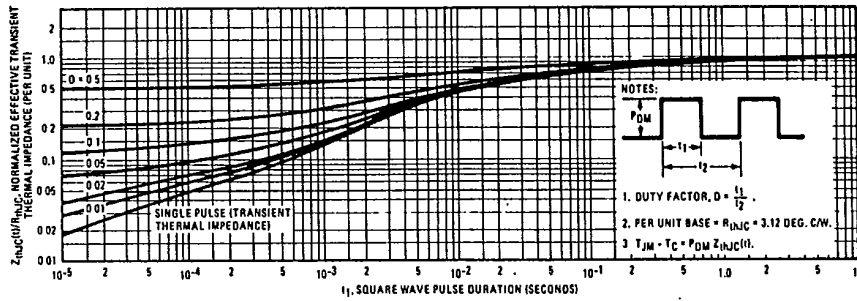

Fig. 5 - Maximum Effective Transient Thermal Impedance, Junction-to-Case Vs. Pulse Duration

IRF720, IRF721, IRF722, IRF723

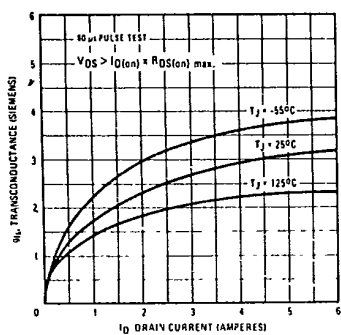

Fig. 6 - Typical Transconductance Vs. Drain Current

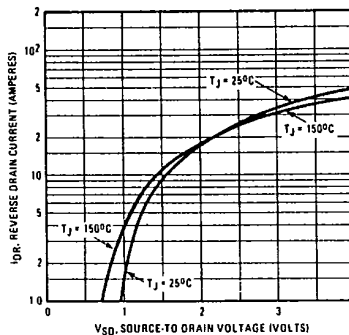

Fig. 7 - Typical Source-Drain Diode Forward Voltage

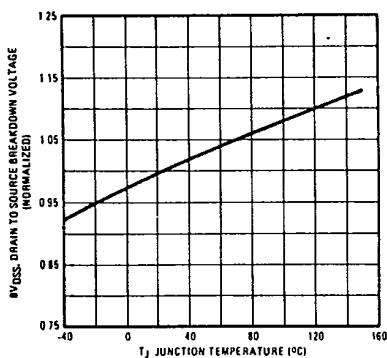

Fig. 8 - Breakdown Voltage Vs. Temperature

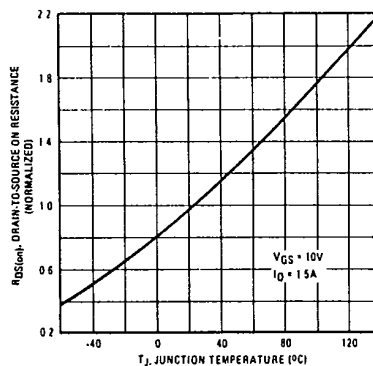

Fig. 9 - Normalized On-Resistance Vs. Temperature

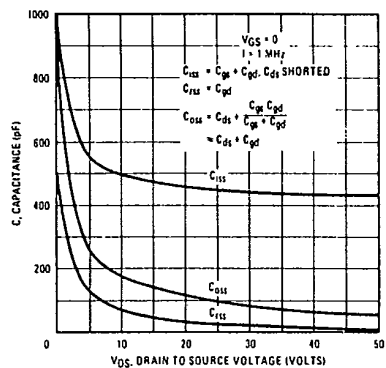

Fig. 10 - Typical Capacitance Vs. Drain-to-Source Voltage

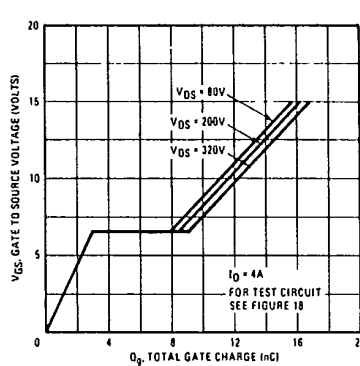

Fig. 11 - Typical Gate Charge Vs. Gate-to-Source Voltage

IRF720, IRF721, IRF722, IRF723

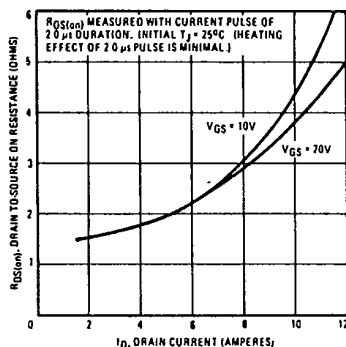

Fig. 12 - Typical On-Resistance Vs. Drain Current

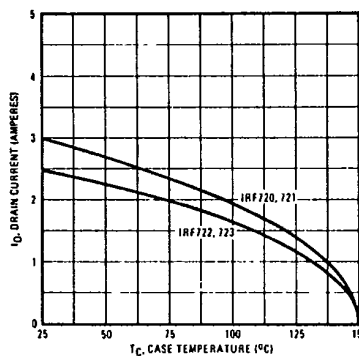

Fig. 13 - Maximum Drain Current Vs. Case Temperature

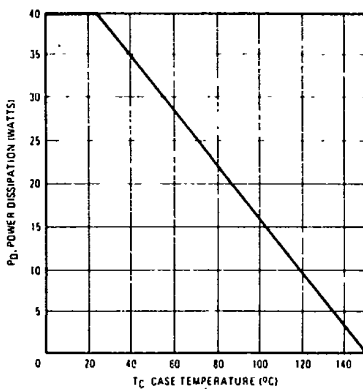

Fig. 14 - Power Vs. Temperature Derating Curve

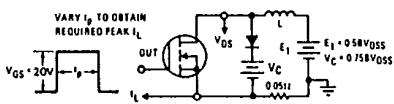

Fig. 15 - Clamped Inductive Test Circuit

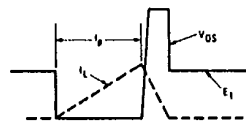

Fig. 16 - Clamped Inductive Waveforms

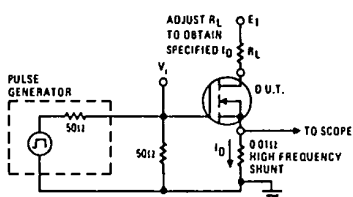

Fig. 17 - Switching Time Test Circuit

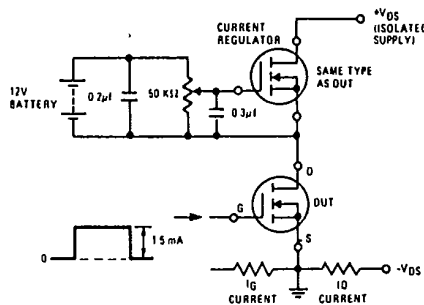

Fig. 18 - Gate Charge Test Circuit