

# Am124/224/324 Am124A/224A/324A

## Quad Op Amps

### Distinctive Characteristics

- In the linear mode the input common-mode voltage range includes ground and the output voltage can also swing to ground, even though operated from only a single power supply voltage.
- The unity gain cross frequency is temperature compensated
- The input bias current is also temperature compensated
- Internally frequency compensated for unity gain
- Large dc voltage gain – 100dB
- Wide bandwidth (unity gain) – 1MHz (temperature compensated)
- Wide power supply range:  
Single supply – 3V to 30V  
Dual supplies –  $\pm 1.5V$  to  $\pm 15V$
- Very low supply current drain ( $800\mu A$ ) – essentially independent of supply voltage (1mW/op amp at +5V)
- Low input biasing current – 45nA (temperature compensated)
- Low input offset voltage – 2mV and offset current – 5nA
- Input common-mode voltage range includes ground
- Differential input voltage range equal to the power supply voltage
- Large output voltage swing – 0V to  $V^+ - 1.5V$

### FUNCTIONAL DESCRIPTION

The Am124 series consists of four independent, high gain, internally frequency compensated operational amplifiers designed primarily to operate from a single power supply over a wide range of voltages. These devices can also operate from split power supplies and the low power supply current drain is independent of the magnitude of the power supply voltage.

Functional applications consist of all the conventional op amp circuits which can now be more easily implemented in single power supply systems along with transducer amplifiers and dc gain blocks.

### CONNECTION DIAGRAM

Top View

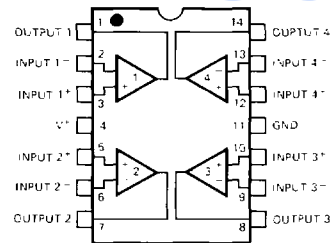

Note: Pin 1 is marked for orientation.

LIC-706

### ORDERING INFORMATION

Part Number	Package Type	Temperature Range	Order Number
Am324	Hermetic DIP	0°C to +70°C	LM324D
	Molded DIP	0°C to +70°C	LM324N
	Dice	0°C to +70°C	LD324
Am224	Hermetic DIP	-25°C to +85°C	LM224D
Am124	Hermetic DIP	-55°C to +125°C	LM124D
	Flat Pack	-55°C to +125°C	LM124F
	Dice	-55°C to +125°C	LM124
Am324A	Hermetic DIP	0°C to +70°C	LM324AD
	Molded DIP	0°C to +70°C	LM324AN
	Dice	0°C to +70°C	LM324A
Am224A	Hermetic DIP	-25°C to +85°C	LM224AD
Am124A	Hermetic DIP	-55°C to +125°C	LM124AD
	Flat Pack	-55°C to +125°C	LM124AF
	Dice	-55°C to +125°C	LD124A

### SCHEMATIC DIAGRAM (Each Amplifier)

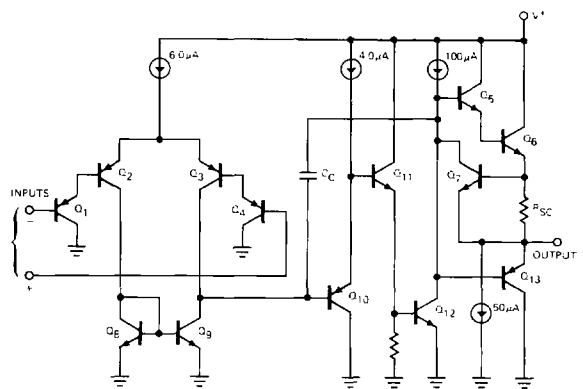

LIC-709

ELECTRICAL CHARACTERISTICS ( $V^+ = +5.0V_{DC}$ , Note 4)

Parameter	Conditions	Am124A			Am224A			Am324A			Am124/Am224			Am324			Units	
		Min.	Typ.	Max.	Min.	Typ.	Max.	Min.	Typ.	Max.	Min.	Typ.	Max.	Min.	Typ.	Max.		
Input Offset Voltage	$T_A = 25^\circ\text{C}$ (Note 5)		1.0	2.0		1.0	3.0		2.0	3.0		+2.0	+5.0		-2.0	-7.0	mV <sub>DC</sub>	
Input Bias Current (Note 6)	$I_{IN(+)} \text{ or } I_{IN(-)}$ , $T_A = 25^\circ\text{C}$		20	50		40	80		45	100		45	150		45	250	nA <sub>DC</sub>	
Input Offset Current	$I_{IN(+)} - I_{IN(-)}$ , $T_A = 25^\circ\text{C}$		2.0	10		2.0	15		5.0	30		-3.0	-30		-5.0	-50	nA <sub>DC</sub>	
Input Common-Mode Voltage Range (Note 7)	$V^+ = 30V_{DC}$ , $T_A = 25^\circ\text{C}$	0		$V^+ - 1.5$	0		$V^+ - 1.5$	0		$V^+ - 1.5$	0		$V^+ - 1.5$	0		$V^+ - 1.5$	V <sub>DC</sub>	
Supply Current	$R_L = \infty$ , $V_{CC} = 30V$		1.5	3.0		1.5	3.0		1.5	3.0		1.5	3.0		1.5	3.0	mA <sub>DC</sub>	
	$R_L = \infty$		0.7	1.2		0.7	1.2		0.7	1.2		0.7	1.2		0.7	1.2		
Large Signal Voltage Gain	$V^+ = 15V_{DC}$ (For large $V_O$ swing); $R_L = 2.0k\Omega$ ; $T_A = 25^\circ\text{C}$	50		100	50		100	25		100	50		100	25		100	V/mV	
Output Voltage Swing	$R_L = 2.0k\Omega$ , $T_A = 25^\circ\text{C}$										0		$V^+ - 1.5$	0		$V^+ - 1.5$	V <sub>DC</sub>	
Common-Mode Rejection Ratio	DC, $T_A = 25^\circ\text{C}$	70		85	70		85	65		85	70		85	65		70	dB	
Power Supply Rejection Ratio	DC, $T_A = 25^\circ\text{C}$	65		100	65		100	65		100	65		100	65		100	dB	
Amplifier to Amplifier Coupling (Note 8)	$f = 1.0\text{kHz}$ to $20\text{kHz}$ , $T_A = 25^\circ\text{C}$ (Input referred)			-120			-120			-120			-120			-120	dB	
Output Current	Source $V_{IN+} = 1.0V_{DC}$ , $V_{IN-} = 0V_{DC}$ $V^+ = 15V_{DC}$ , $T_A = 25^\circ\text{C}$	20		40	20		40	20		40	20		40	20		40	mA <sub>DC</sub>	
	Sink $V_{IN+} = 1.0V_{DC}$ , $V_{IN-} = 0V_{DC}$ $V^+ = 15V_{DC}$ , $T_A = 25^\circ\text{C}$	10		20	10		20	10		20	10		20	10		20		
	$V_{IN+} = 1.0V_{DC}$ , $V_{IN-} = 0V_{DC}$ $T_A = 25^\circ\text{C}$ , $V_O = 200\text{mV}_{DC}$	12		50	12		50	12		50	12		50	12		50		
Short Circuit to Ground	$T_A = 25^\circ\text{C}$ (Note 2)		40	60		40	60		40	60		40	60		40	60	mA <sub>DC</sub>	
Input Offset Voltage	Note 5			4.0			4.0			5.0			-7.0			-9.0	mV <sub>DC</sub>	
Input Offset Voltage Drift	$R_S = 0\Omega$			7.0			20			7.0			30			7.0	$\mu\text{V}/^\circ\text{C}$	
Input Offset Current	$I_{IN(+)} - I_{IN(-)}$			30			30			75			-100			-150	nA <sub>DC</sub>	
Input Offset Current Drift				10			200			10			300			10	pA <sub>DC}/^\circ\text{C}</sub>	
Input Bias Current	$I_{IN(+)} \text{ or } I_{IN(-)}$			40			100			40			200			40	500	nA <sub>DC</sub>
Input Common-Mode Voltage Range (Note 7)	$V^+ = 30V_{DC}$	0		$V^+ - 2.0$	0		$V^+ - 2.0$	0		$V^+ - 2.0$	0		$V^+ - 2.0$	0		$V^+ - 2.0$	V <sub>DC</sub>	
Large Signal Voltage Gain	$V^+ = 15V_{DC}$ (For large $V_O$ swing); $R_L = 2.0k\Omega$	25			25			15			25			15			V/mV	
Output Voltage Swing	$V_{OH}$ $V^+ = 30V_{DC}$ , $R_L = 2.0k\Omega$	26			26			26			26			26			V <sub>DC</sub>	
	$V_{OL}$ $R_L = 10k\Omega$	27	28		27	28		27	28		27	28		27	28			
Output Current	Source $V_{IN+} = 1.0V_{DC}$ , $V_{IN-} = 0V_{DC}$ $V^+ = 15V_{DC}$	10		20	10		20	10		20	10		20	10		20	mA	
	Sink $V_{IN+} = 1.0V_{DC}$ , $V_{IN-} = 0V_{DC}$ $V^+ = 15V_{DC}$	10		15	5.0		8.0	5.0		8.0	5.0		8.0	5.0		8.0		
Differential Input Voltage	Note 7			$V^+$			$V^+$			$V^+$			$V^+$			$V^+$	V <sub>DC</sub>	

- Notes: 1. For operating at high temperatures, the Am324 must be derated based on a  $+125^\circ\text{C}$  maximum junction temperature and a thermal resistance of  $175^\circ\text{C}/\text{W}$  which applies for the device soldered in a printed circuit board, operating in a still air ambient. The Am224 and Am124 can be derated based on a  $+150^\circ\text{C}$  maximum junction temperature. The dissipation is the total of all four amplifiers — use external resistors, where possible to allow the amplifier to saturate or to reduce the power which is dissipated in the integrated circuit.
2. Short circuits from the output to  $V^+$  can cause excessive heating and eventual destruction. The maximum output current is approximately 40mA independent of the magnitude of  $V^+$ . At values of supply voltage in excess of +15V, continuous short-circuits can exceed the power dissipation ratings and cause eventual destruction.
3. This input current will only exist when the voltage at any of the input leads is driven negative. It is due to the collector-base junction of the input PNP transistors becoming forward biased and thereby acting as input diode clamps. In addition to this diode action, there is also lateral NPN parasitic transistor action on the IC chip. This transistor action can cause the output voltages of the op amps to go to the  $V^+$  voltage level (or to ground for a large overdrive) for the time duration that an input is driven negative. This is not destructive and normal output states will re-establish when the input voltage, which was negative, again returns to a value greater than  $-0.3V$ .
4. These specifications apply for  $V^+ = +5V_{DC}$  and  $-55^\circ\text{C} \leq T_A \leq +125^\circ\text{C}$ , unless otherwise stated. With the Am224, all temperature specifications are limited to  $-25^\circ\text{C} \leq T_A \leq +85^\circ\text{C}$  and the Am324 temperature specifications are limited to  $0^\circ\text{C} \leq T_A \leq +70^\circ\text{C}$ .
5.  $V_O = 1.4V$ ,  $R_S = 0\Omega$  with  $V^+$  from 5V to 30V; and over the full input common-mode range (0V to  $V^+ - 1.5V$ ).
6. The direction of the input current is out of the IC due to the PNP input stage. This current is essentially constant, independent of the state of the output so no loading change exists on the input lines.
7. The input common-mode voltage or either input signal voltage should not be allowed to go negative by more than 0.3V. The upper end of the common-mode voltage range is  $V^+ - 1.5V$ , but either or both inputs can go to  $+32V$  without damage.
8. Due to proximity of external components, insure that coupling is not originating via stray capacitance between these external parts. This typically can be detected as this type of capacitive coupling increases at higher frequencies.

6

# Am124/224/324 • Am124A/224A/324A

## MAXIMUM RATINGS (Above which the useful life may be impaired)

Supply Voltage, $V^+$	32V or $\pm 16V$
Differential Input Voltage	32V
Input Voltage	-0.3V to +32V
Power Dissipation (Note 1)	
Molded DIP	570mW
Cavity DIP	900mW
Flat Pak (Am124F)	800mW
Output Short Circuit to GND (Note 2)	
(One Amplifier) $V^+ \leq 15V$ and $T_A = 25^\circ C$	Continuous
Input Current ( $V_{IN} < -0.3V_{OL}$ ) (Note 3)	50mA
Operating Temperature Range	
Am324/Am324A	0°C to +70°C
Am224/Am224A	-25°C to +85°C
Am124/Am124A	-55°C to +125°C
Storage Temperature Range	-65°C to +150°C
Lead Temperature (Soldering, 10 seconds)	300°C

## TYPICAL PERFORMANCE CURVES

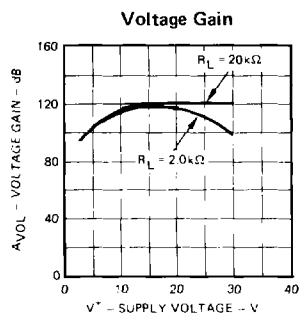
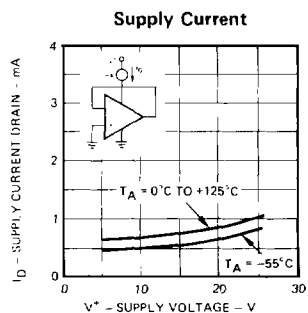
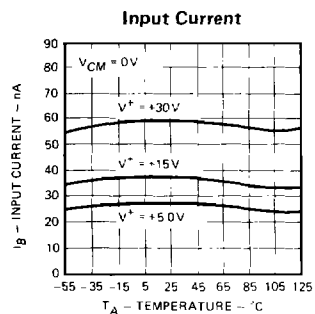
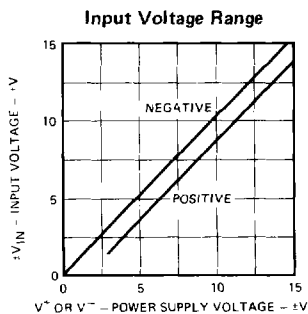

TYPICAL PERFORMANCE CURVES (Cont.)

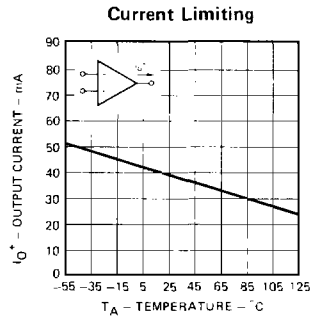
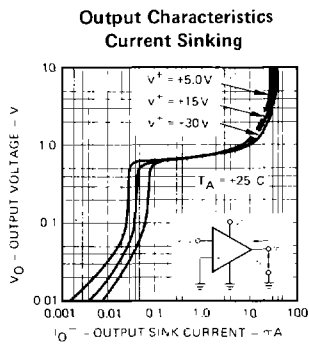
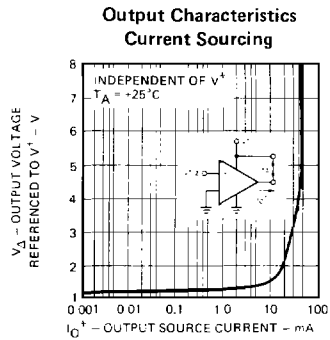
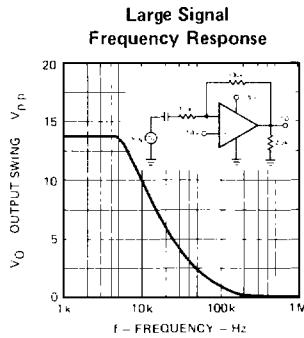
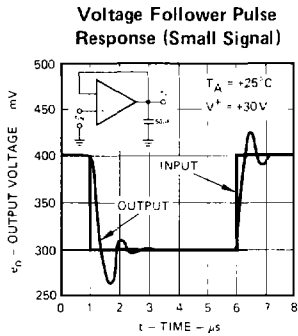
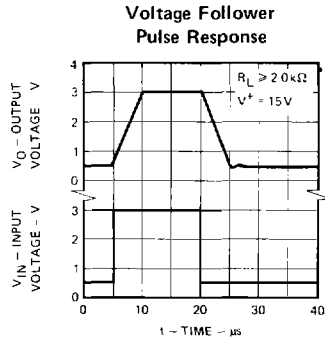
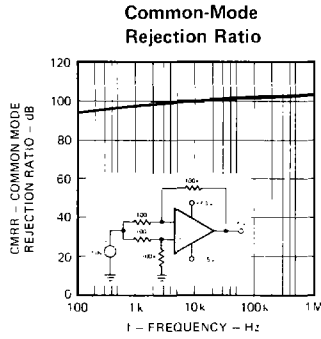
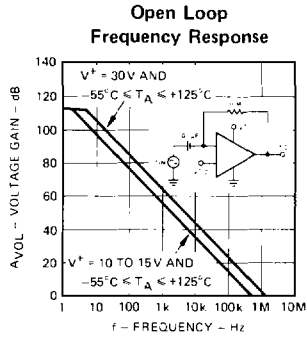

6

## Metallization and Pad Layout

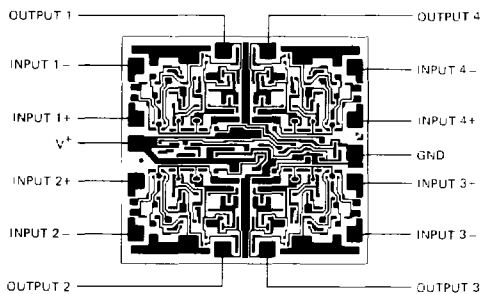

58 x 63 MILS

## APPLICATION INFORMATION

The Am124 series are op amps primarily operating from a single power supply voltage and have true-differential inputs remaining in the linear mode with an input common-mode voltage of 0V. These amplifiers operate over a wide range of power supply voltage with little change in performance characteristics. The bias network of the amplifier establishes a drain current independent of the magnitude of the power supply voltage over the range of from 3V to 30V.

The pin configuration is designed to simplify PC board layouts. Since the amplifier outputs are placed at the corners of the package (pins 1, 7, 8, and 14) and are adjacent to the inverting inputs.

Extra care should be taken to insure that the power for the circuit never becomes reversed in polarity or that the unit is not inadvertently installed backwards in a test socket. This prevents a possible fusing of the internal conductors and becoming a destroyed unit which could occur from the unlimited current surge through the resulting forward diode within the IC.

The use of input differential voltage protection diodes is not needed since large differential voltages can be readily applied resulting in no large input currents. The differential input voltage may be larger than  $V^+$  without damaging the device. Protection, such as an input clamp diode with a resistor to the IC input terminal, should be provided to prevent the input voltages from going negative more than  $-0.3V$  (at  $25^\circ C$ ).

The amplifiers contain a class A output stage for small signal levels which converts to class B in a large signal mode, to reduce the power supply current drain. Since this allows the amplifiers to both source and sink large output currents, both NPN and PNP external current boost transistors can be used to extend the power capability of the basic amplifiers. The output voltage needs to rise approximately 1 diode drop above

ground to bias the on-chip vertical PNP transistor for output current sinking applications.

For AC coupled applications crossover distortion can be minimized by utilizing a resistor from the output of the amplifier to ground. However, in DC applications, where the load is directly coupled, there is no crossover distortion.

To maintain resistance to destruction, output short circuits either to ground or to the positive power supply should be restricted to short time durations. The possibility of destruction exists, not as a result of the short circuit current metal fusing, but rather due to the large increase in IC chip dissipation which will cause eventual failure due to excessive junction temperatures. Putting direct short circuits on more than one amplifier at a time increases the total IC power dissipation to destructive levels, if not properly protected with external dissipation limiting resistors in series with the output leads of the amplifiers. The larger value of output source current which is available at  $25^\circ C$  provides a larger output current capability at elevated temperatures (see section on typical performance characteristics) than a standard IC op amp.

Capacitive loads which are applied directly to the output of the amplifier reduce the loop stability margin. Values of 50pF can be accommodated using the worst case noninverting unity gain connection. Large closed loop gains or resistive isolation should be used if larger load capacitance must be driven by the amplifier.

The series, as presented in the section on typical applications, emphasize operations on only a single power supply voltage. Yet, if complementary power supplies are available, all of the standard op amp circuits can be implemented. A unique feature in introducing a pseudo-ground (a bias voltage reference of  $V^+/2$ ) is allowing operation above and below this value in single power supply systems. In most cases, input biasing is not required and input voltages which range to ground can be easily accommodated.