

SN54LS640 THRU SN54LS642, SN54LS644, SN54LS645 SN74LS640 THRU SN74LS642, SN74LS644, SN74LS645 OCTAL BUS TRANSCEIVERS

SDLS189 – APRIL 1979 – REVISED MARCH 1988

- **SN74LS64X-1 Versions Rated at I_{OL} of 48 mA**
- **Bi-directional Bus Transceivers in High-Density 20-Pin Packages**
- **Hysteresis at Bus Inputs Improves Noise Margins**
- **Choice of True or Inverting Logic**
- **Choice of 3-State or Open-Collector Outputs**

DEVICE	OUTPUT	LOGIC
'LS640	3-State	Inverting
'LS641	Open-Collector	True
'LS642	Open-Collector	Inverting
'LS644	Open-Collector	True and inverting
'LS645	3-State	True

description

These octal bus transceivers are designed for asynchronous two-way communication between data buses. The devices transmit data from the A bus to the B bus or from the B bus to the A bus depending upon the level at the direction control (DIR) input. The enable input (\bar{G}) can be used to disable the device so the buses are effectively isolated.

The -1 versions of the SN74LS640 thru SN74LS642, SN74LS644, and SN74LS645 are identical to the standard versions except that the recommended maximum I_{OL} is increased to 48 milliamperes. There are no -1 versions of the SN54LS640 thru SN54LS642, SN54LS644, and SN54LS645.

The SN54LS640 thru SN54LS642, SN54LS644, and SN54LS645 are characterized for operation over the full military temperature range of -55°C to 125°C . The SN74LS640 thru SN74LS642, SN74LS644, and SN74LS645 are characterized for operation from 0°C to 70°C .

SN54LS' . . . J PACKAGE
SN74LS' . . . DW OR N PACKAGE
(TOP VIEW)



SN54LS' . . . FK PACKAGE
(TOP VIEW)

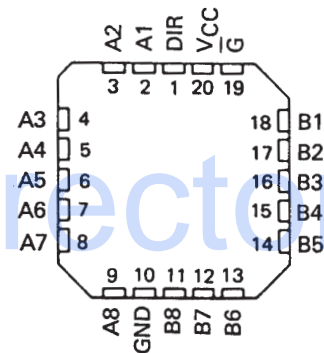

FUNCTION TABLE

CONTROL INPUTS		OPERATION		
\bar{G}	DIR	'LS640 'LS642	'LS641 'LS645	'LS644
L	L	B data to A bus	B data to A bus	B data to A bus
L	H	A data to B bus	A data to B bus	\bar{A} data to B bus
H	X	Isolation	Isolation	Isolation

H = high level, L = low level, X = irrelevant

SN54LS640 THRU SN54LS642, SN54LS644, SN54LS645 SN74LS640 THRU SN74LS642, SN74LS644, SN74LS645 OCTAL BUS TRANSCEIVERS

SDLS189 – APRIL 1979 – REVISED MARCH 1988

logic symbols†

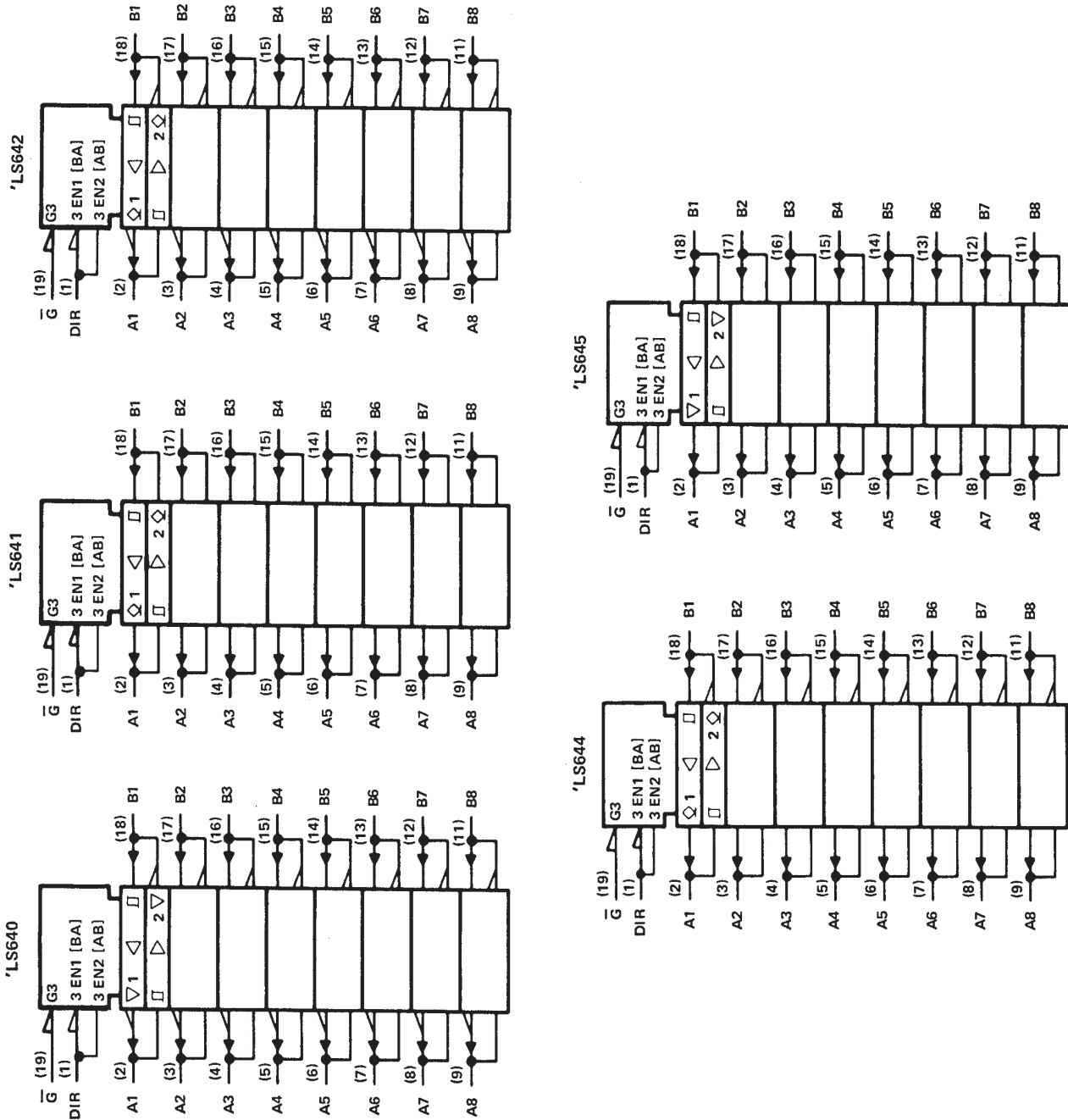

† These symbols are in accordance with ANSI/IEEE Std 91-1984 and IEC Publication 617-12.
Pin numbers shown are for DW, J, and N packages.

SN54LS640, SN54LS645
SN74LS640, SN74LS645
OCTAL BUS TRANSCEIVERS WITH 3-STATE OUTPUTS

SDLS189 – APRIL 1979 – REVISED MARCH 1988

absolute maximum ratings over operating free-air temperature range (unless otherwise noted)

Supply voltage, V_{CC} (see Note 1)	7 V
Input voltage: All inputs	7 V
I/O ports	5.5 V
Operating free-air temperature range: SN54LS640, SN54LS645	-55°C to 125°C
SN74LS640, SN74LS645	0°C to 70°C
Storage temperature range	-65°C to 150°C

NOTE 1: Voltage values are with respect to network ground terminal.

recommended operating conditions

PARAMETER	SN54LS640 SN54LS645			SN74LS640 SN74LS645			UNIT
	MIN	NOM	MAX	MIN	NOM	MAX	
V_{CC} Supply voltage	4.5	5	5.5	4.75	5	5.25	V
V_{IH} High-level input voltage	2			2			V
V_{IL} Low-level input voltage			0.5			0.6	V
I_{OH} High-level output current			-12			-15	mA
I_{OL} Low-level output current			12			24	mA
						48†	
T_A Operating free-air temperature	-55		125	0		70	°C

†The 48-mA limit applies for the SN74LS640-1 and SN74LS645-1 only.

electrical characteristics over recommended operating free-air temperature range (unless otherwise noted)

PARAMETER	TEST CONDITIONS†	SN54LS640 SN54LS645			SN74LS640 SN74LS645			UNIT	
		MIN	TYP‡	MAX	MIN	TYP‡	MAX		
V_{IK}	$V_{CC} = \text{MIN}, I_I = -18 \text{ mA}$			-1.5			-1.5	V	
Hysteresis ($V_{T+} - V_{T-}$)	$V_{CC} = \text{MIN},$ A or B input	0.1	0.4		0.2	0.4		V	
V_{OH}	$V_{CC} = \text{MIN}, V_{IH} = 2 \text{ V},$ $V_{IL} = \text{MAX}$	$I_{OH} = -3 \text{ mA}$	2.4	3.4	2.4	3.4			
		$I_{OH} = \text{MAX}$	2		2				
V_{OL}	$V_{CC} = \text{MIN}, V_{IH} = 2 \text{ V},$ $V_{IL} = \text{MAX}$	$I_{OL} = 12 \text{ mA}$	0.25	0.4	0.25	0.4		V	
		$I_{OL} = 24 \text{ mA}$			0.35	0.5			
		$I_{OL} = 48 \text{ mA}^\#$			0.4	0.5			
I_{OZH}	$V_{CC} = \text{MAX}, \bar{G} \text{ at } 2 \text{ V}, V_O = 2.7 \text{ V}$			20			20	μA	
I_{OZL}	$V_{CC} = \text{MAX}, \bar{G} \text{ at } 2 \text{ V}, V_O = 0.4 \text{ V}$			-0.4			-0.4	mA	
I_I	A or B DIR or \bar{G}	$V_{CC} = \text{MAX}$	$V_I = 5.5 \text{ V}$			0.1		0.1	mA
			$V_I = 7 \text{ V}$			0.1		0.1	
I_{IH}	$V_{CC} = \text{MAX}, V_{IH} = 2.7 \text{ V}$			20			20	μA	
I_{IL}	$V_{CC} = \text{MAX}, V_{IL} = 0.4 \text{ V}$			-0.4			-0.4	mA	
I_{OS}^\ddagger	$V_{CC} = \text{MAX}$	-40		-225	-40		-225	mA	
I_{CC}	Outputs high		48	70		48	70	mA	
	Outputs low		62	90		62	90		
	Outputs at Hi-Z		64	95		64	95		

†For conditions shown as MIN or MAX, use the appropriate value specified under recommended operating conditions.

‡All typical values are at $V_{CC} = 5 \text{ V}, T_A = 25^\circ\text{C}$.

¶Not more than one output should be shorted at a time, and duration of the short-circuit should not exceed one second.

#The 48-mA condition applies for the SN74LS640-1 and SN74LS645-1 only.



SN54LS640, SN54LS645
SN74LS640, SN74LS645
OCTAL BUS TRANSCEIVERS WITH 3-STATE OUTPUTS

SDLS189 – APRIL 1979 – REVISED MARCH 1988

switching characteristics, $V_{CC} = 5\text{ V}$, $T_A = 25^\circ\text{C}$

PARAMETER	FROM (INPUT)	TO (OUTPUT)	TEST CONDITIONS	'LS640, 'LS640-1			'LS645, 'LS645-1			UNIT
				MIN	TYP	MAX	MIN	TYP	MAX	
t_{PLH} Propagation delay time, low-to-high-level output	A	B	$C_L = 45\text{ pF}$, $R_L = 667\ \Omega$, See Note 2		6	10		8	15	ns
	B	A			6	10		8	15	
t_{PHL} Propagation delay time, high-to-low-level output	A	B			8	15		11	15	ns
	B	A			8	15		11	15	
t_{PZL} Output enable time to low level	\overline{G}	A			31	40		31	40	ns
	\overline{G}	B			31	40		31	40	
t_{PZH} Output enable time to high level	\overline{G}	A			23	40		26	40	ns
	\overline{G}	B			23	40		26	40	
t_{PLZ} Output disable time from low level	\overline{G}	A	$C_L = 5\text{ pF}$, $R_L = 667\ \Omega$, See Note 2		15	25		15	25	ns
	\overline{G}	B			15	25		15	25	
t_{PHZ} Output disable time from high level	\overline{G}	A			15	25		15	25	ns
	\overline{G}	B			15	25		15	25	

NOTE 2: Load circuits and voltage waveforms are shown in Section 1.

schematics of inputs and outputs



TYPICAL CHARACTERISTICS

SN54LS'
 INVERTING OUTPUT VOLTAGE
 vs
 INPUT VOLTAGE

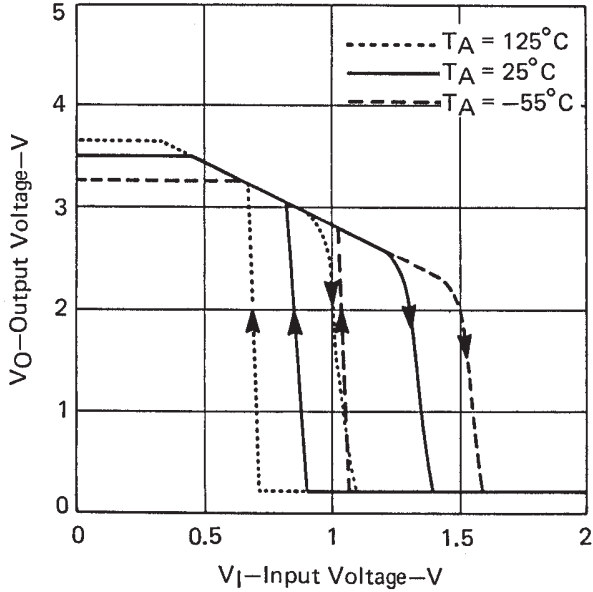

FIGURE 1

SN74LS'
 INVERTING OUTPUT VOLTAGE
 vs
 INPUT VOLTAGE

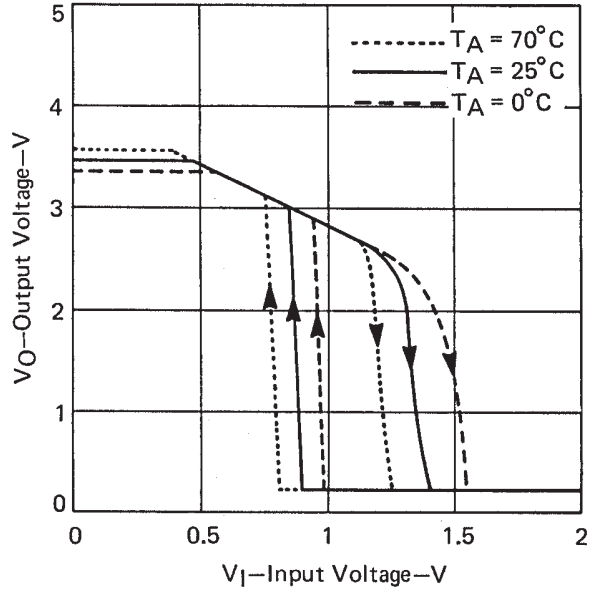

FIGURE 2

SN54LS'
 NONINVERTING OUTPUT VOLTAGE
 vs
 INPUT VOLTAGE

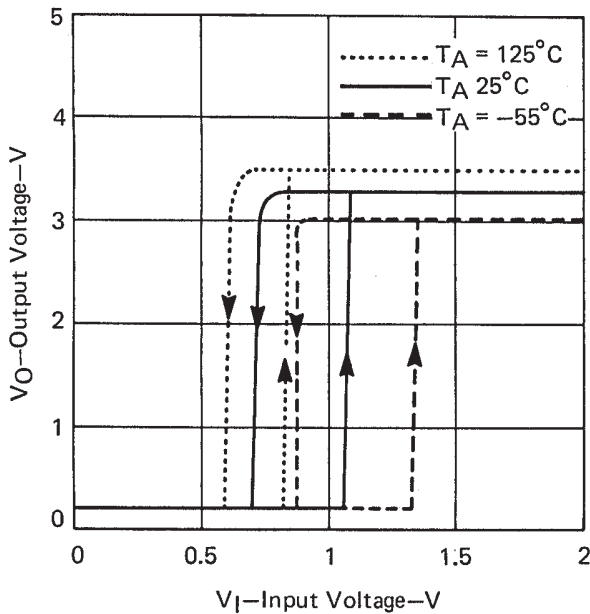

FIGURE 3

SN74LS'
 NONINVERTING OUTPUT VOLTAGE
 vs
 INPUT VOLTAGE

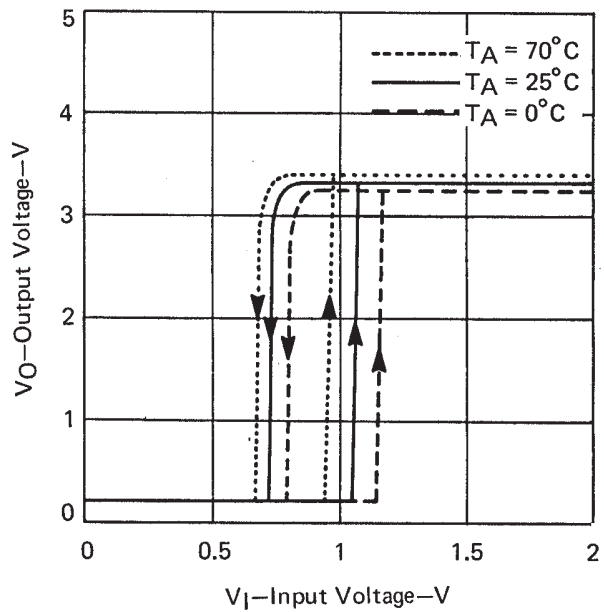

FIGURE 4

SN54LS641, SN54LS642, SN54LS644
SN74LS641, SN74LS642, SN74LS644
OCTAL BUS TRANSCEIVERS WITH OPEN-COLLECTOR OUTPUTS

SDLS189 – APRIL 1979 – REVISED MARCH 1988

absolute maximum ratings over operating free-air temperature range (unless otherwise noted)

Supply voltage, V_{CC} (see Note 1)	7 V
Input voltage: All inputs and I/O ports	7 V
Operating free-air temperature range: SN54LS641, SN54LS642, SN54LS644	– 55° C to 125° C
SN74LS641, SN74LS642, SN74LS644	0° C to 70° C
Storage temperature range	– 65° C to 150° C

NOTE 1: Voltage values are with respect to network ground terminal.

recommended operating conditions

PARAMETER	SN54LS641 SN54LS642 SN54LS644			SN74LS641 SN74LS642 SN74LS644			UNIT
	MIN	NOM	MAX	MIN	NOM	MAX	
	V_{CC} Supply voltage	4.5	5	5.5	4.75	5	
V_{IH} High-level input voltage	2			2			V
V_{IL} Low-level input voltage	0.5			0.6			V
V_{OH} High-level output voltage	5.5			5.5			V
I_{OL} Low-level output current	12			24			mA
				48 §			
T_A Operating free-air temperature	– 55 125			0 70			°C

§ The 48 mA limit applies for the SN74LS641-1, SN74LS642-1, and SN74LS644-1 only.

electrical characteristics over recommended operating free-air temperature range (unless otherwise noted)

PARAMETER	TEST CONDITIONS †	SN54LS641 SN54LS642 SN54LS644			SN74LS641 SN74LS642 SN74LS644			UNIT
		MIN	TYP ‡	MAX	MIN	TYP ‡	MAX	
		V_{IK}	$V_{CC} = \text{MIN}, I_I = -18 \text{ mA}$	– 1.5			– 1.5	
Hysteresis ($V_{T+} - V_{T-}$)	$V_{CC} = \text{MIN}, A \text{ or } B \text{ input}$	0.1	0.4		0.2	0.4		V
I_{OH}	$V_{CC} = \text{MIN}, V_{IH} = 2 \text{ V}, V_{IL} = \text{MAX}, V_{OH} = 5.5 \text{ V}$	0.1			0.1			mA
V_{OL}	$V_{CC} = \text{MIN}, V_{IH} = 2 \text{ V}, V_{IL} = \text{MAX}$	$I_{OL} = 12 \text{ mA}$	0.25	0.4	0.25	0.4	V	
		$I_{OL} = 24 \text{ mA}$				0.35		0.5
		$I_{OL} = 48 \text{ mA} §$				0.4		0.5
I_I	A or B	$V_{CC} = \text{MAX}$	$V_I = 5.5 \text{ V}$	0.1			0.1	mA
	DIR or \bar{G}		$V_I = 7 \text{ V}$	0.1			0.1	
I_{IH}	$V_{CC} = \text{MAX}, V_I = 2.7 \text{ V}$	20			20			μA
I_{IL}	$V_{CC} = \text{MAX}, V_I = 0.4 \text{ V}$	– 0.4			– 0.4			mA
I_{CC}	Outputs high	$V_{CC} = \text{MAX},$ Outputs open	48	70	48	70	mA	
	Outputs low		62	90	62	90		
	Outputs at Hi-Z		64	95	64	95		

† For conditions shown as MIN or MAX, use the appropriate value specified under recommended operating conditions.

‡ All typical values are at $V_{CC} = 5 \text{ V}, T_A = 25^\circ \text{C}$.

§ The 48 mA condition applies for the SN74LS641-1, SN74LS642-1, and SN74LS644-1 only.



SN54LS641, SN54LS642, SN54LS644
 SN74LS641, SN74LS642, SN74LS644
 OCTAL BUS TRANSCEIVERS WITH OPEN-COLLECTOR OUTPUTS

SDLS189 – APRIL 1979 – REVISED MARCH 1988

switching characteristics at $V_{CC} = 5\text{ V}$, $T_A = 25^\circ\text{C}$

PARAMETER	FROM (INPUT)	TO (OUTPUT)	'LS641, 'LS641-1		'LS642, 'LS642-1		'LS644, 'LS644-1		UNIT
			MIN	TYP	MAX	MIN	TYP	MAX	
t _{PLH} Propagation delay time, low-to-high-level output	A	B	17	25	19	25	17	25	ns
	B	A	17	25	19	25	19	25	
t _{PHL} Propagation delay time, high-to-low-level output	A	B	16	25	14	25	14	25	ns
	B	A	16	25	14	25	16	25	
t _{PLH} Output disable time from low level	\bar{G} , DIR	A	23	40	26	40	26	40	ns
	\bar{G} , DIR	B	25	40	28	40	25	40	
t _{PHL} Output enable time from high level	\bar{G} , DIR	A	34	50	43	60	43	60	ns
	\bar{G} , DIR	B	37	50	39	60	37	50	

TEST CONDITIONS
 $C_L = 45\text{ pF}$,
 $R_L = 667\ \Omega$,
 See Note 2

NOTE 2: Load circuits and voltage waveforms are shown in Section 1.

schematics of inputs and outputs

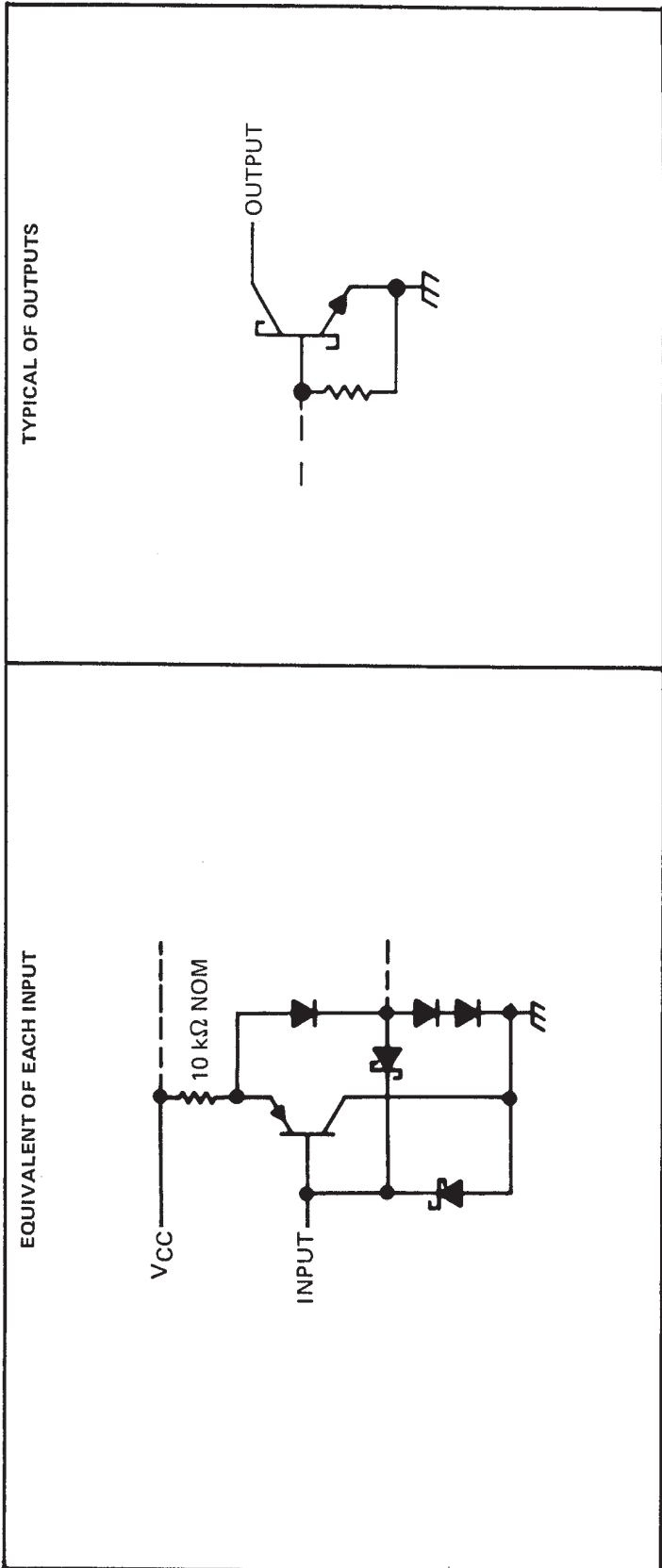

PACKAGING INFORMATION

Orderable Device	Status ⁽¹⁾	Package Type	Package Drawing	Pins	Package Qty	Eco Plan ⁽²⁾	Lead/ Ball Finish	MSL Peak Temp ⁽³⁾	Samples (Requires Login)
5962-8416101VRA	ACTIVE	CDIP	J	20	20	TBD	A42	N / A for Pkg Type	
5962-8416101VSA	ACTIVE	CFP	W	20	25	TBD	Call TI	N / A for Pkg Type	
84161012A	ACTIVE	LCCC	FK	20	1	TBD	Call TI	Call TI	
8416101RA	ACTIVE	CDIP	J	20	1	TBD	Call TI	Call TI	
8416101SA	ACTIVE	CFP	W	20	1	TBD	Call TI	Call TI	
SN54LS640J	ACTIVE	CDIP	J	20	1	TBD	A42	N / A for Pkg Type	
SN54LS645J	ACTIVE	CDIP	J	20	1	TBD	A42	N / A for Pkg Type	
SN74LS640-1DW	ACTIVE	SOIC	DW	20	25	Green (RoHS & no Sb/Br)	CU NIPDAU	Level-1-260C-UNLIM	
SN74LS640-1DWE4	ACTIVE	SOIC	DW	20	25	Green (RoHS & no Sb/Br)	CU NIPDAU	Level-1-260C-UNLIM	
SN74LS640-1DWG4	ACTIVE	SOIC	DW	20	25	Green (RoHS & no Sb/Br)	CU NIPDAU	Level-1-260C-UNLIM	
SN74LS640-1DWR	OBSOLETE	SOIC	DW	20		TBD	Call TI	Call TI	
SN74LS640-1N	ACTIVE	PDIP	N	20	20	Pb-Free (RoHS)	CU NIPDAU	N / A for Pkg Type	
SN74LS640-1NE4	ACTIVE	PDIP	N	20	20	Pb-Free (RoHS)	CU NIPDAU	N / A for Pkg Type	
SN74LS640-1NSR	ACTIVE	SO	NS	20	2000	Green (RoHS & no Sb/Br)	CU NIPDAU	Level-1-260C-UNLIM	
SN74LS640-1NSRE4	ACTIVE	SO	NS	20	2000	Green (RoHS & no Sb/Br)	CU NIPDAU	Level-1-260C-UNLIM	
SN74LS640-1NSRG4	ACTIVE	SO	NS	20	2000	Green (RoHS & no Sb/Br)	CU NIPDAU	Level-1-260C-UNLIM	
SN74LS640DW	ACTIVE	SOIC	DW	20	25	Green (RoHS & no Sb/Br)	CU NIPDAU	Level-1-260C-UNLIM	
SN74LS640DWE4	ACTIVE	SOIC	DW	20	25	Green (RoHS & no Sb/Br)	CU NIPDAU	Level-1-260C-UNLIM	
SN74LS640DWG4	ACTIVE	SOIC	DW	20	25	Green (RoHS & no Sb/Br)	CU NIPDAU	Level-1-260C-UNLIM	
SN74LS640DWR	ACTIVE	SOIC	DW	20	2000	Green (RoHS & no Sb/Br)	CU NIPDAU	Level-1-260C-UNLIM	
SN74LS640DWRE4	ACTIVE	SOIC	DW	20	2000	Green (RoHS & no Sb/Br)	CU NIPDAU	Level-1-260C-UNLIM	

Orderable Device	Status ⁽¹⁾	Package Type	Package Drawing	Pins	Package Qty	Eco Plan ⁽²⁾	Lead/ Ball Finish	MSL Peak Temp ⁽³⁾	Samples (Requires Login)
SN74LS640DWRG4	ACTIVE	SOIC	DW	20	2000	Green (RoHS & no Sb/Br)	CU NIPDAU	Level-1-260C-UNLIM	
SN74LS640N	ACTIVE	PDIP	N	20	20	Pb-Free (RoHS)	CU NIPDAU	N / A for Pkg Type	
SN74LS640N3	OBSOLETE	PDIP	N	20		TBD	Call TI	Call TI	
SN74LS640NE4	ACTIVE	PDIP	N	20	20	Pb-Free (RoHS)	CU NIPDAU	N / A for Pkg Type	
SN74LS640NSR	ACTIVE	SO	NS	20	2000	Green (RoHS & no Sb/Br)	CU NIPDAU	Level-1-260C-UNLIM	
SN74LS640NSRE4	ACTIVE	SO	NS	20	2000	Green (RoHS & no Sb/Br)	CU NIPDAU	Level-1-260C-UNLIM	
SN74LS640NSRG4	ACTIVE	SO	NS	20	2000	Green (RoHS & no Sb/Br)	CU NIPDAU	Level-1-260C-UNLIM	
SN74LS641-1DW	ACTIVE	SOIC	DW	20	25	Green (RoHS & no Sb/Br)	CU NIPDAU	Level-1-260C-UNLIM	
SN74LS641-1DWE4	ACTIVE	SOIC	DW	20	25	Green (RoHS & no Sb/Br)	CU NIPDAU	Level-1-260C-UNLIM	
SN74LS641-1DWG4	ACTIVE	SOIC	DW	20	25	Green (RoHS & no Sb/Br)	CU NIPDAU	Level-1-260C-UNLIM	
SN74LS641-1DWR	ACTIVE	SOIC	DW	20	2000	Green (RoHS & no Sb/Br)	CU NIPDAU	Level-1-260C-UNLIM	
SN74LS641-1DWRE4	ACTIVE	SOIC	DW	20	2000	Green (RoHS & no Sb/Br)	CU NIPDAU	Level-1-260C-UNLIM	
SN74LS641-1DWRG4	ACTIVE	SOIC	DW	20	2000	Green (RoHS & no Sb/Br)	CU NIPDAU	Level-1-260C-UNLIM	
SN74LS641-1N	ACTIVE	PDIP	N	20	20	Pb-Free (RoHS)	CU NIPDAU	N / A for Pkg Type	
SN74LS641-1N3	OBSOLETE	PDIP	N	20		TBD	Call TI	Call TI	
SN74LS641-1NE4	ACTIVE	PDIP	N	20	20	Pb-Free (RoHS)	CU NIPDAU	N / A for Pkg Type	
SN74LS641DW	ACTIVE	SOIC	DW	20	25	Green (RoHS & no Sb/Br)	CU NIPDAU	Level-1-260C-UNLIM	
SN74LS641DWE4	ACTIVE	SOIC	DW	20	25	Green (RoHS & no Sb/Br)	CU NIPDAU	Level-1-260C-UNLIM	
SN74LS641DWG4	ACTIVE	SOIC	DW	20	25	Green (RoHS & no Sb/Br)	CU NIPDAU	Level-1-260C-UNLIM	
SN74LS641DWR	ACTIVE	SOIC	DW	20		TBD	Call TI	Call TI	
SN74LS641DWRE4	ACTIVE	SOIC	DW	20		TBD	Call TI	Call TI	
SN74LS641DWRG4	ACTIVE	SOIC	DW	20		TBD	Call TI	Call TI	

Orderable Device	Status ⁽¹⁾	Package Type	Package Drawing	Pins	Package Qty	Eco Plan ⁽²⁾	Lead/ Ball Finish	MSL Peak Temp ⁽³⁾	Samples (Requires Login)
SN74LS641N	ACTIVE	PDIP	N	20	20	Pb-Free (RoHS)	CU NIPDAU	N / A for Pkg Type	
SN74LS641N3	OBSOLETE	PDIP	N	20		TBD	Call TI	Call TI	
SN74LS641NE4	ACTIVE	PDIP	N	20	20	Pb-Free (RoHS)	CU NIPDAU	N / A for Pkg Type	
SN74LS641NSR	ACTIVE	SO	NS	20	2000	Green (RoHS & no Sb/Br)	CU NIPDAU	Level-1-260C-UNLIM	
SN74LS641NSRE4	ACTIVE	SO	NS	20	2000	Green (RoHS & no Sb/Br)	CU NIPDAU	Level-1-260C-UNLIM	
SN74LS641NSRG4	ACTIVE	SO	NS	20	2000	Green (RoHS & no Sb/Br)	CU NIPDAU	Level-1-260C-UNLIM	
SN74LS642-1DW	ACTIVE	SOIC	DW	20	25	Green (RoHS & no Sb/Br)	CU NIPDAU	Level-1-260C-UNLIM	
SN74LS642-1DWE4	ACTIVE	SOIC	DW	20	25	Green (RoHS & no Sb/Br)	CU NIPDAU	Level-1-260C-UNLIM	
SN74LS642-1DWG4	ACTIVE	SOIC	DW	20	25	Green (RoHS & no Sb/Br)	CU NIPDAU	Level-1-260C-UNLIM	
SN74LS642-1N	ACTIVE	PDIP	N	20	20	Pb-Free (RoHS)	CU NIPDAU	N / A for Pkg Type	
SN74LS642-1NE4	ACTIVE	PDIP	N	20	20	Pb-Free (RoHS)	CU NIPDAU	N / A for Pkg Type	
SN74LS642DW	ACTIVE	SOIC	DW	20	25	Green (RoHS & no Sb/Br)	CU NIPDAU	Level-1-260C-UNLIM	
SN74LS642DWE4	ACTIVE	SOIC	DW	20	25	Green (RoHS & no Sb/Br)	CU NIPDAU	Level-1-260C-UNLIM	
SN74LS642DWG4	ACTIVE	SOIC	DW	20	25	Green (RoHS & no Sb/Br)	CU NIPDAU	Level-1-260C-UNLIM	
SN74LS642N	ACTIVE	PDIP	N	20	20	Pb-Free (RoHS)	CU NIPDAU	N / A for Pkg Type	
SN74LS642NE4	ACTIVE	PDIP	N	20	20	Pb-Free (RoHS)	CU NIPDAU	N / A for Pkg Type	
SN74LS642NSR	ACTIVE	SO	NS	20	2000	Green (RoHS & no Sb/Br)	CU NIPDAU	Level-1-260C-UNLIM	
SN74LS642NSRE4	ACTIVE	SO	NS	20	2000	Green (RoHS & no Sb/Br)	CU NIPDAU	Level-1-260C-UNLIM	
SN74LS642NSRG4	ACTIVE	SO	NS	20	2000	Green (RoHS & no Sb/Br)	CU NIPDAU	Level-1-260C-UNLIM	
SN74LS644-1N	OBSOLETE	PDIP	N	20		TBD	Call TI	Call TI	
SN74LS644N	OBSOLETE	PDIP	N	20		TBD	Call TI	Call TI	
SN74LS645-1DW	ACTIVE	SOIC	DW	20	25	Green (RoHS & no Sb/Br)	CU NIPDAU	Level-1-260C-UNLIM	

Orderable Device	Status ⁽¹⁾	Package Type	Package Drawing	Pins	Package Qty	Eco Plan ⁽²⁾	Lead/ Ball Finish	MSL Peak Temp ⁽³⁾	Samples (Requires Login)
SN74LS645-1DWE4	ACTIVE	SOIC	DW	20	25	Green (RoHS & no Sb/Br)	CU NIPDAU	Level-1-260C-UNLIM	
SN74LS645-1DWG4	ACTIVE	SOIC	DW	20	25	Green (RoHS & no Sb/Br)	CU NIPDAU	Level-1-260C-UNLIM	
SN74LS645-1DWR	ACTIVE	SOIC	DW	20	2000	Green (RoHS & no Sb/Br)	CU NIPDAU	Level-1-260C-UNLIM	
SN74LS645-1DWRE4	ACTIVE	SOIC	DW	20	2000	Green (RoHS & no Sb/Br)	CU NIPDAU	Level-1-260C-UNLIM	
SN74LS645-1DWRG4	ACTIVE	SOIC	DW	20	2000	Green (RoHS & no Sb/Br)	CU NIPDAU	Level-1-260C-UNLIM	
SN74LS645-1N	ACTIVE	PDIP	N	20	20	Pb-Free (RoHS)	CU NIPDAU	N / A for Pkg Type	
SN74LS645-1N3	OBSOLETE	PDIP	N	20		TBD	Call TI	Call TI	
SN74LS645-1NE4	ACTIVE	PDIP	N	20	20	Pb-Free (RoHS)	CU NIPDAU	N / A for Pkg Type	
SN74LS645-1NSR	ACTIVE	SO	NS	20	2000	Green (RoHS & no Sb/Br)	CU NIPDAU	Level-1-260C-UNLIM	
SN74LS645-1NSRE4	ACTIVE	SO	NS	20	2000	Green (RoHS & no Sb/Br)	CU NIPDAU	Level-1-260C-UNLIM	
SN74LS645-1NSRG4	ACTIVE	SO	NS	20	2000	Green (RoHS & no Sb/Br)	CU NIPDAU	Level-1-260C-UNLIM	
SN74LS645DW	ACTIVE	SOIC	DW	20	25	Green (RoHS & no Sb/Br)	CU NIPDAU	Level-1-260C-UNLIM	
SN74LS645DWE4	ACTIVE	SOIC	DW	20	25	Green (RoHS & no Sb/Br)	CU NIPDAU	Level-1-260C-UNLIM	
SN74LS645DWG4	ACTIVE	SOIC	DW	20	25	Green (RoHS & no Sb/Br)	CU NIPDAU	Level-1-260C-UNLIM	
SN74LS645DWR	OBSOLETE	SOIC	DW	20		TBD	Call TI	Call TI	
SN74LS645N	ACTIVE	PDIP	N	20	20	Pb-Free (RoHS)	CU NIPDAU	N / A for Pkg Type	
SN74LS645N3	OBSOLETE	PDIP	N	20		TBD	Call TI	Call TI	
SN74LS645NE4	ACTIVE	PDIP	N	20	20	Pb-Free (RoHS)	CU NIPDAU	N / A for Pkg Type	
SN74LS645NSR	ACTIVE	SO	NS	20	2000	Green (RoHS & no Sb/Br)	CU NIPDAU	Level-1-260C-UNLIM	
SN74LS645NSRE4	ACTIVE	SO	NS	20	2000	Green (RoHS & no Sb/Br)	CU NIPDAU	Level-1-260C-UNLIM	
SN74LS645NSRG4	ACTIVE	SO	NS	20	2000	Green (RoHS & no Sb/Br)	CU NIPDAU	Level-1-260C-UNLIM	

Orderable Device	Status ⁽¹⁾	Package Type	Package Drawing	Pins	Package Qty	Eco Plan ⁽²⁾	Lead/ Ball Finish	MSL Peak Temp ⁽³⁾	Samples (Requires Login)
SNJ54LS640FK	ACTIVE	LCCC	FK	20	1	TBD	POST-PLATE	N / A for Pkg Type	
SNJ54LS640J	ACTIVE	CDIP	J	20	1	TBD	A42	N / A for Pkg Type	
SNJ54LS640W	ACTIVE	CFP	W	20	1	TBD	Call TI	N / A for Pkg Type	
SNJ54LS645FK	NRND	LCCC	FK	20	1	TBD	POST-PLATE	N / A for Pkg Type	
SNJ54LS645J	ACTIVE	CDIP	J	20	1	TBD	A42	N / A for Pkg Type	
SNJ54LS645W	OBSOLETE	CFP	W	20		TBD	Call TI	Call TI	

⁽¹⁾ The marketing status values are defined as follows:

ACTIVE: Product device recommended for new designs.

LIFEBUY: TI has announced that the device will be discontinued, and a lifetime-buy period is in effect.

NRND: Not recommended for new designs. Device is in production to support existing customers, but TI does not recommend using this part in a new design.

PREVIEW: Device has been announced but is not in production. Samples may or may not be available.

OBSOLETE: TI has discontinued the production of the device.

⁽²⁾ Eco Plan - The planned eco-friendly classification: Pb-Free (RoHS), Pb-Free (RoHS Exempt), or Green (RoHS & no Sb/Br) - please check <http://www.ti.com/productcontent> for the latest availability information and additional product content details.

TBD: The Pb-Free/Green conversion plan has not been defined.

Pb-Free (RoHS): TI's terms "Lead-Free" or "Pb-Free" mean semiconductor products that are compatible with the current RoHS requirements for all 6 substances, including the requirement that lead not exceed 0.1% by weight in homogeneous materials. Where designed to be soldered at high temperatures, TI Pb-Free products are suitable for use in specified lead-free processes.

Pb-Free (RoHS Exempt): This component has a RoHS exemption for either 1) lead-based flip-chip solder bumps used between the die and package, or 2) lead-based die adhesive used between the die and leadframe. The component is otherwise considered Pb-Free (RoHS compatible) as defined above.

Green (RoHS & no Sb/Br): TI defines "Green" to mean Pb-Free (RoHS compatible), and free of Bromine (Br) and Antimony (Sb) based flame retardants (Br or Sb do not exceed 0.1% by weight in homogeneous material)

⁽³⁾ MSL, Peak Temp. -- The Moisture Sensitivity Level rating according to the JEDEC industry standard classifications, and peak solder temperature.

Important Information and Disclaimer: The information provided on this page represents TI's knowledge and belief as of the date that it is provided. TI bases its knowledge and belief on information provided by third parties, and makes no representation or warranty as to the accuracy of such information. Efforts are underway to better integrate information from third parties. TI has taken and continues to take reasonable steps to provide representative and accurate information but may not have conducted destructive testing or chemical analysis on incoming materials and chemicals. TI and TI suppliers consider certain information to be proprietary, and thus CAS numbers and other limited information may not be available for release.

In no event shall TI's liability arising out of such information exceed the total purchase price of the TI part(s) at issue in this document sold by TI to Customer on an annual basis.

OTHER QUALIFIED VERSIONS OF SN54LS640, SN54LS640-SP, SN54LS645, SN74LS640, SN74LS645 :

● Catalog: [SN74LS640](#), [SN54LS640](#), [SN74LS645](#)

- Military: [SN54LS640](#), [SN54LS645](#)

- Space: [SN54LS640-SP](#)

NOTE: Qualified Version Definitions:

- Catalog - TI's standard catalog product
- Military - QML certified for Military and Defense Applications
- Space - Radiation tolerant, ceramic packaging and qualified for use in Space-based application

TAPE AND REEL INFORMATION
REEL DIMENSIONS

TAPE DIMENSIONS

A0	Dimension designed to accommodate the component width
B0	Dimension designed to accommodate the component length
K0	Dimension designed to accommodate the component thickness
W	Overall width of the carrier tape
P1	Pitch between successive cavity centers

TAPE AND REEL INFORMATION

*All dimensions are nominal

Device	Package Type	Package Drawing	Pins	SPQ	Reel Diameter (mm)	Reel Width W1 (mm)	A0 (mm)	B0 (mm)	K0 (mm)	P1 (mm)	W (mm)	Pin1 Quadrant
SN74LS640-1NSR	SO	NS	20	2000	330.0	24.4	8.2	13.0	2.5	12.0	24.0	Q1
SN74LS640DWR	SOIC	DW	20	2000	330.0	24.4	10.8	13.0	2.7	12.0	24.0	Q1
SN74LS640NSR	SO	NS	20	2000	330.0	24.4	8.2	13.0	2.5	12.0	24.0	Q1
SN74LS641-1DWR	SOIC	DW	20	2000	330.0	24.4	10.8	13.0	2.7	12.0	24.0	Q1
SN74LS641NSR	SO	NS	20	2000	330.0	24.4	8.2	13.0	2.5	12.0	24.0	Q1
SN74LS642NSR	SO	NS	20	2000	330.0	24.4	8.2	13.0	2.5	12.0	24.0	Q1
SN74LS645-1DWR	SOIC	DW	20	2000	330.0	24.4	10.8	13.0	2.7	12.0	24.0	Q1
SN74LS645-1NSR	SO	NS	20	2000	330.0	24.4	8.2	13.0	2.5	12.0	24.0	Q1
SN74LS645NSR	SO	NS	20	2000	330.0	24.4	8.2	13.0	2.5	12.0	24.0	Q1

TAPE AND REEL BOX DIMENSIONS

*All dimensions are nominal

Device	Package Type	Package Drawing	Pins	SPQ	Length (mm)	Width (mm)	Height (mm)
SN74LS640-1NSR	SO	NS	20	2000	367.0	367.0	45.0
SN74LS640DWR	SOIC	DW	20	2000	367.0	367.0	45.0
SN74LS640NSR	SO	NS	20	2000	367.0	367.0	45.0
SN74LS641-1DWR	SOIC	DW	20	2000	367.0	367.0	45.0
SN74LS641NSR	SO	NS	20	2000	367.0	367.0	45.0
SN74LS642NSR	SO	NS	20	2000	367.0	367.0	45.0
SN74LS645-1DWR	SOIC	DW	20	2000	367.0	367.0	45.0
SN74LS645-1NSR	SO	NS	20	2000	367.0	367.0	45.0
SN74LS645NSR	SO	NS	20	2000	367.0	367.0	45.0

J (R-GDIP-T**)

14 LEADS SHOWN

CERAMIC DUAL IN-LINE PACKAGE



DIM \ PINS **	14	16	18	20
A	0.300 (7,62) BSC	0.300 (7,62) BSC	0.300 (7,62) BSC	0.300 (7,62) BSC
B MAX	0.785 (19,94)	.840 (21,34)	0.960 (24,38)	1.060 (26,92)
B MIN	—	—	—	—
C MAX	0.300 (7,62)	0.300 (7,62)	0.310 (7,87)	0.300 (7,62)
C MIN	0.245 (6,22)	0.245 (6,22)	0.220 (5,59)	0.245 (6,22)

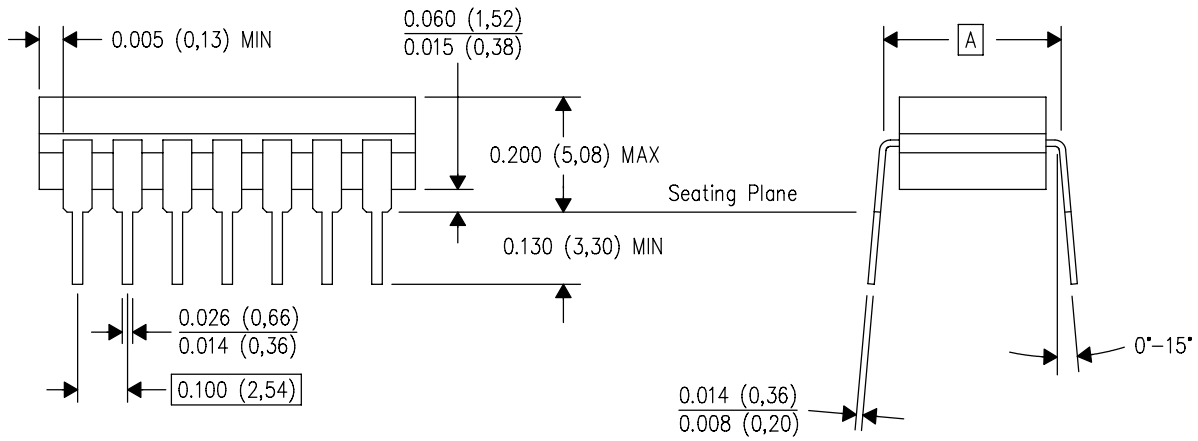

4040083/F 03/03

- NOTES:
- All linear dimensions are in inches (millimeters).
 - This drawing is subject to change without notice.
 - This package is hermetically sealed with a ceramic lid using glass frit.
 - Index point is provided on cap for terminal identification only on press ceramic glass frit seal only.
 - Falls within MIL STD 1835 GDIP1-T14, GDIP1-T16, GDIP1-T18 and GDIP1-T20.

W (R-GDFP-F20)

CERAMIC DUAL FLATPACK



- NOTES:
- A. All linear dimensions are in inches (millimeters).
 - B. This drawing is subject to change without notice.
 - C. This package can be hermetically sealed with a ceramic lid using glass frit.
 - D. Index point is provided on cap for terminal identification only.
 - E. Falls within Mil-Std 1835 GDFP2-F20

FK (S-CQCC-N**)

LEADLESS CERAMIC CHIP CARRIER

28 TERMINAL SHOWN



NO. OF TERMINALS **	A		B	
	MIN	MAX	MIN	MAX
20	0.342 (8,69)	0.358 (9,09)	0.307 (7,80)	0.358 (9,09)
28	0.442 (11,23)	0.458 (11,63)	0.406 (10,31)	0.458 (11,63)
44	0.640 (16,26)	0.660 (16,76)	0.495 (12,58)	0.560 (14,22)
52	0.740 (18,78)	0.761 (19,32)	0.495 (12,58)	0.560 (14,22)
68	0.938 (23,83)	0.962 (24,43)	0.850 (21,6)	0.858 (21,8)
84	1.141 (28,99)	1.165 (29,59)	1.047 (26,6)	1.063 (27,0)



4040140/D 01/11

- NOTES:
- All linear dimensions are in inches (millimeters).
 - This drawing is subject to change without notice.
 - This package can be hermetically sealed with a metal lid.
 - Falls within JEDEC MS-004

DW (R-PDSO-G20)

PLASTIC SMALL OUTLINE

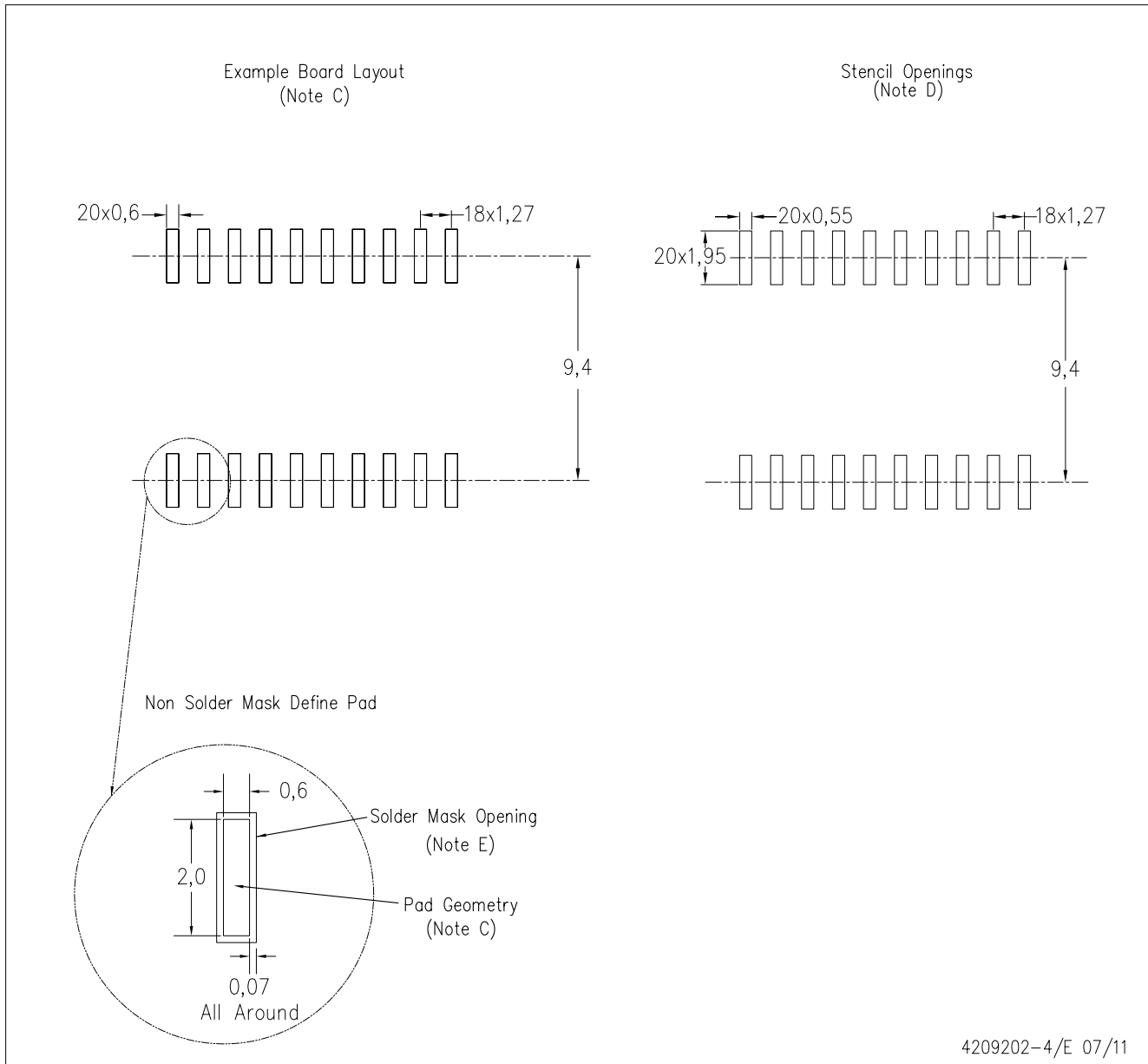

4209202-4/E 07/11

- NOTES:
- A. All linear dimensions are in millimeters.
 - B. This drawing is subject to change without notice.
 - C. Refer to IPC7351 for alternate board design.
 - D. Laser cutting apertures with trapezoidal walls and also rounding corners will offer better paste release. Customers should contact their board assembly site for stencil design recommendations. Refer to IPC-7525
 - E. Customers should contact their board fabrication site for solder mask tolerances between and around signal pads.

MECHANICAL DATA

NS (R-PDSO-G)**

PLASTIC SMALL-OUTLINE PACKAGE

14-PINS SHOWN



- NOTES:
- A. All linear dimensions are in millimeters.
 - B. This drawing is subject to change without notice.
 - C. Body dimensions do not include mold flash or protrusion, not to exceed 0,15.

IMPORTANT NOTICE

Texas Instruments Incorporated and its subsidiaries (TI) reserve the right to make corrections, enhancements, improvements and other changes to its semiconductor products and services per JESD46C and to discontinue any product or service per JESD48B. Buyers should obtain the latest relevant information before placing orders and should verify that such information is current and complete. All semiconductor products (also referred to herein as "components") are sold subject to TI's terms and conditions of sale supplied at the time of order acknowledgment.

TI warrants performance of its components to the specifications applicable at the time of sale, in accordance with the warranty in TI's terms and conditions of sale of semiconductor products. Testing and other quality control techniques are used to the extent TI deems necessary to support this warranty. Except where mandated by applicable law, testing of all parameters of each component is not necessarily performed.

TI assumes no liability for applications assistance or the design of Buyers' products. Buyers are responsible for their products and applications using TI components. To minimize the risks associated with Buyers' products and applications, Buyers should provide adequate design and operating safeguards.

TI does not warrant or represent that any license, either express or implied, is granted under any patent right, copyright, mask work right, or other intellectual property right relating to any combination, machine, or process in which TI components or services are used. Information published by TI regarding third-party products or services does not constitute a license to use such products or services or a warranty or endorsement thereof. Use of such information may require a license from a third party under the patents or other intellectual property of the third party, or a license from TI under the patents or other intellectual property of TI.

Reproduction of significant portions of TI information in TI data books or data sheets is permissible only if reproduction is without alteration and is accompanied by all associated warranties, conditions, limitations, and notices. TI is not responsible or liable for such altered documentation. Information of third parties may be subject to additional restrictions.

Resale of TI components or services with statements different from or beyond the parameters stated by TI for that component or service voids all express and any implied warranties for the associated TI component or service and is an unfair and deceptive business practice. TI is not responsible or liable for any such statements.

Buyer acknowledges and agrees that it is solely responsible for compliance with all legal, regulatory and safety-related requirements concerning its products, and any use of TI components in its applications, notwithstanding any applications-related information or support that may be provided by TI. Buyer represents and agrees that it has all the necessary expertise to create and implement safeguards which anticipate dangerous consequences of failures, monitor failures and their consequences, lessen the likelihood of failures that might cause harm and take appropriate remedial actions. Buyer will fully indemnify TI and its representatives against any damages arising out of the use of any TI components in safety-critical applications.

In some cases, TI components may be promoted specifically to facilitate safety-related applications. With such components, TI's goal is to help enable customers to design and create their own end-product solutions that meet applicable functional safety standards and requirements. Nonetheless, such components are subject to these terms.

No TI components are authorized for use in FDA Class III (or similar life-critical medical equipment) unless authorized officers of the parties have executed a special agreement specifically governing such use.

Only those TI components which TI has specifically designated as military grade or "enhanced plastic" are designed and intended for use in military/aerospace applications or environments. Buyer acknowledges and agrees that any military or aerospace use of TI components which have **not** been so designated is solely at the Buyer's risk, and that Buyer is solely responsible for compliance with all legal and regulatory requirements in connection with such use.

TI has specifically designated certain components which meet ISO/TS16949 requirements, mainly for automotive use. Components which have not been so designated are neither designed nor intended for automotive use; and TI will not be responsible for any failure of such components to meet such requirements.

Products

Audio	www.ti.com/audio
Amplifiers	amplifier.ti.com
Data Converters	dataconverter.ti.com
DLP® Products	www.dlp.com
DSP	dsp.ti.com
Clocks and Timers	www.ti.com/clocks
Interface	interface.ti.com
Logic	logic.ti.com
Power Mgmt	power.ti.com
Microcontrollers	microcontroller.ti.com
RFID	www.ti-rfid.com
OMAP Mobile Processors	www.ti.com/omap
Wireless Connectivity	www.ti.com/wirelessconnectivity

Applications

Automotive and Transportation	www.ti.com/automotive
Communications and Telecom	www.ti.com/communications
Computers and Peripherals	www.ti.com/computers
Consumer Electronics	www.ti.com/consumer-apps
Energy and Lighting	www.ti.com/energy
Industrial	www.ti.com/industrial
Medical	www.ti.com/medical
Security	www.ti.com/security
Space, Avionics and Defense	www.ti.com/space-avionics-defense
Video and Imaging	www.ti.com/video

TI E2E Community e2e.ti.com