

LM4040 Precision Micropower Shunt Voltage Reference

General Description

Ideal for space critical applications, the LM4040 precision voltage reference is available in the sub-miniature (3 mm x 1.3 mm) SOT-23 surface-mount package. The LM4040's advanced design eliminates the need for an external stabilizing capacitor while ensuring stability with any capacitive load, thus making the LM4040 easy to use. Further reducing design effort is the availability of several fixed reverse breakdown voltages: 2.500V, 4.096V, 5.000V, 8.192V, and 10.000V. The minimum operating current increases from 60 μ A for the LM4040-2.5 to 100 μ A for the LM4040-10.0. All versions have a maximum operating current of 15 mA.

The LM4040 utilizes fuse and zener-zap reverse breakdown voltage trim during wafer sort to ensure that the prime parts have an accuracy of better than $\pm 0.1\%$ (A grade) at 25°C. Bandgap reference temperature drift curvature correction and low dynamic impedance ensure stable reverse breakdown voltage accuracy over a wide range of operating temperatures and currents.

Also available is the LM4041 with two reverse breakdown voltage versions: adjustable and 1.2V. Please see the LM4041 data sheet.

Features

- Small packages: SOT-23, TO-92
- No output capacitor required

- Tolerates capacitive loads
- Fixed reverse breakdown voltages of 2.500V, 4.096V, 5.000V, 8.192V, and 10.000V

Key Specifications (LM4040-2.5)

- | | |
|--|---------------------------------|
| ■ Output voltage tolerance (A grade, 25°C) | $\pm 0.1\%$ (max) |
| ■ Low output noise (10 Hz to 10 kHz) | 35 μ V _{rms} (typ) |
| ■ Wide operating current range | 60 μ A to 15 mA |
| ■ Industrial temperature range | -40°C to +85°C |
| ■ Extended temperature range | -40°C to +125°C |
| ■ Low temperature coefficient | 100 ppm/°C (max) |

Applications

- Portable, Battery-Powered Equipment
- Data Acquisition Systems
- Instrumentation
- Process Control
- Energy Management
- Product Testing
- Automotive
- Precision Audio Components

Connection Diagrams

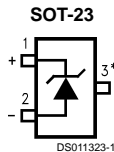

*This pin must be left floating or connected to pin 2.

Top View
See NS Package Number M03B
(JEDEC Registration TO-236AB)

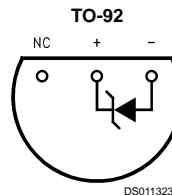

Bottom View
See NS Package Number Z03A

Ordering Information

Industrial Temperature Range (–40 °C to +85 °C)

Reverse Breakdown Voltage Tolerance at 25°C and Average Reverse Breakdown Voltage Temperature Coefficient	Package	
	M3 (SOT-23)	Z (TO-92)
±0.1%, 100 ppm/°C max (A grade)	LM4040AIM3-2.5, LM4040AIM3-4.1, LM4040AIM3-5.0, LM4040AIM3-8.2, LM4040AIM3-10.0 See NS Package Number M03B	LM4040AIZ-2.5, LM4040AIZ-4.1, LM4040AIZ-5.0, LM4040AIZ-8.2, LM4040AIZ-10.0 See NS Package Number Z03A
±0.2%, 100 ppm/°C max (B grade)	LM4040BIM3-2.5, LM4040BIM3-4.1, LM4040BIM3-5.0, LM4040BIM3-8.2, LM4040BIM3-10.0 See NS Package Number M03B	LM4040BIZ-2.5, LM4040BIZ-4.1, LM4040BIZ-5.0, LM4040BIZ-8.2, LM4040BIZ-10.0 See NS Package Number Z03A
±0.5%, 100 ppm/°C max (C grade)	LM4040CIM3-2.5, LM4040CIM3-4.1, LM4040CIM3-5.0, LM4040CIM3-8.2, LM4040CIM3-10.0 See NS Package Number M03B	LM4040CIZ-2.5, LM4040CIZ-4.1, LM4040CIZ-5.0, LM4040CIZ-8.2, LM4040CIZ-10.0 See NS Package Number Z03A
±1.0%, 150 ppm/°C max (D grade)	LM4040DIM3-2.5, LM4040DIM3-4.1, LM4040DIM3-5.0, LM4040DIM3-8.2, LM4040DIM3-10.0 See NS Package Number M03B	LM4040DIZ-2.5, LM4040DIZ-4.1, LM4040DIZ-5.0, LM4040DIZ-10.0, See NS Package Number Z03A
±2.0%, 150 ppm/°C max (E grade)	LM4040EIM3-2.5 See NS Package Number M03B	LM4040EIZ-2.5 See NS Package Number Z03A

Ordering Information (Continued)

Extended Temperature Range (–40 °C to +125 °C)

Reverse Breakdown Voltage Tolerance at 25 °C and Average Reverse Breakdown Voltage Temperature Coefficient	Package
	M3 (SOT-23) See NS Package Number M03B
±0.5%, 100 ppm/°C max (C grade)	LM4040CEM3-2.5, LM4040CEM3-5.0
±1.0%, 150 ppm/°C max (D grade)	LM4040DEM3-2.5, LM4040DEM3-5.0
±2.0%, 150 ppm/°C max (E grade)	LM4040EEM3-2.5

SOT-23 Package Marking Information

Only three fields of marking are possible on the SOT-23's small surface. This table gives the meaning of the three fields.

Part Marking	Field Definition
R2A R4A R5A R8A R0A	First Field: R = Reference Second Field: 2 = 2.500V Voltage Option 4 = 4.096V Voltage Option 5 = 5.000V Voltage Option
R2B R4B R5B R8B R0B	8 = 8.192V Voltage Option 0 = 10.000V Voltage Option
R2C R4C R5C R8C R0C	Third Field: A–E = Initial Reverse Breakdown Voltage or Reference Voltage Tolerance A = ±0.1%, B = ±0.2%, C = +0.5%, D = ±1.0%, E = ±2.0%
R2D R4D R5D R8D R0D	
R2E	

Absolute Maximum Ratings (Note 1)

If Military/Aerospace specified devices are required, please contact the National Semiconductor Sales Office/Distributors for availability and specifications.

Reverse Current	20 mA
Forward Current	10 mA
Power Dissipation ($T_A = 25^\circ\text{C}$) (Note 2)	
M3 Package	306 mW
Z Package	550 mW
Storage Temperature	-65°C to $+150^\circ\text{C}$
Lead Temperature	
M3 Package	
Vapor phase (60 seconds)	$+215^\circ\text{C}$
Infrared (15 seconds)	$+220^\circ\text{C}$
Z Package	
Soldering (10 seconds)	$+260^\circ\text{C}$
ESD Susceptibility	

Human Body Model (Note 3)	2 kV
Machine Model (Note 3)	200V

See AN-450 "Surface Mounting Methods and Their Effect on Product Reliability" for other methods of soldering surface mount devices.

Operating Ratings (Notes 1, 2)

Temperature Range	$(T_{\min} \leq T_A \leq T_{\max})$
Industrial Temperature Range	$-40^\circ\text{C} \leq T_A \leq +85^\circ\text{C}$
Extended Temperature Range	$-40^\circ\text{C} \leq T_A \leq +125^\circ\text{C}$
Reverse Current	
LM4040-2.5	60 μA to 15 mA
LM4040-4.1	68 μA to 15 mA
LM4040-5.0	74 μA to 15 mA
LM4040-8.2	91 μA to 15 mA
LM4040-10.0	100 μA to 15 mA

LM4040-2.5 Electrical Characteristics (Industrial Temperature Range)

Boldface limits apply for $T_A = T_J = T_{\min}$ to T_{\max} ; all other limits $T_A = T_J = 25^\circ\text{C}$. The grades A and B designate initial Reverse Breakdown Voltage tolerances of $\pm 0.1\%$ and $\pm 0.2\%$, respectively.

Symbol	Parameter	Conditions	Typical (Note 4)	LM4040AIM3 LM4040AIZ Limits (Note 5)	LM4040BIM3 LM4040BIZ Limits (Note 5)	Units (Limit)
V_R	Reverse Breakdown Voltage	$I_R = 100 \mu\text{A}$	2.500			V
	Reverse Breakdown Voltage Tolerance (Note 6)	$I_R = 100 \mu\text{A}$		± 2.5 ± 19	± 5.0 ± 21	mV (max) mV (max)
$I_{R\min}$	Minimum Operating Current		45	60	60	μA
				65	65	μA (max) μA (max)
$\Delta V_R/\Delta T$	Average Reverse Breakdown Voltage Temperature Coefficient (Note 6)	$I_R = 10 \text{ mA}$	± 20			ppm/ $^\circ\text{C}$
		$I_R = 1 \text{ mA}$	± 15	± 100	± 100	ppm/ $^\circ\text{C}$ (max)
		$I_R = 100 \mu\text{A}$	± 15			ppm/ $^\circ\text{C}$
$\Delta V_R/\Delta I_R$	Reverse Breakdown Voltage Change with Operating Current Change	$I_{R\min} \leq I_R \leq 1 \text{ mA}$	0.3	0.8 1.0	0.8 1.0	mV mV (max) mV (max)
		$1 \text{ mA} \leq I_R \leq 15 \text{ mA}$	2.5	6.0 8.0	6.0 8.0	mV mV (max) mV (max)
Z_R	Reverse Dynamic Impedance	$I_R = 1 \text{ mA}$, $f = 120 \text{ Hz}$, $I_{AC} = 0.1 I_R$	0.3	0.8	0.8	Ω Ω (max)
e_N	Wideband Noise	$I_R = 100 \mu\text{A}$ $10 \text{ Hz} \leq f \leq 10 \text{ kHz}$	35			μV_{rms}
ΔV_R	Reverse Breakdown Voltage Long Term Stability	$t = 1000 \text{ hrs}$ $T = 25^\circ\text{C} \pm 0.1^\circ\text{C}$ $I_R = 100 \mu\text{A}$	120			ppm

LM4040-2.5 Electrical Characteristics (Industrial Temperature Range)

Boldface limits apply for $T_A = T_J = T_{MIN}$ to T_{MAX} ; all other limits $T_A = T_J = 25^\circ\text{C}$. The grades C, D and E designate initial Reverse Breakdown Voltage tolerances of $\pm 0.5\%$, $\pm 1.0\%$ and $\pm 2.0\%$, respectively.

Symbol	Parameter	Conditions	Typical (Note 4)	LM4040CIM3 LM4040CIZ Limits (Note 5)	LM4040DIM3 LM4040DIZ Limits (Note 5)	LM4040EIZ Limits (Note 5)	Units (Limit)	
V_R	Reverse Breakdown Voltage	$I_R = 100 \mu\text{A}$	2.500				V	
	Reverse Breakdown Voltage Tolerance (Note 6)	$I_R = 100 \mu\text{A}$		± 12 ± 29	± 25 ± 49	± 50 ± 74	mV (max) mV (max)	
I_{RMIN}	Minimum Operating Current		45	60 65	65 70	65 70	μA μA (max) μA (max)	
		Average Reverse Breakdown Voltage Temperature Coefficient (Note 6)	$I_R = 10 \text{ mA}$ $I_R = 1 \text{ mA}$ $I_R = 100 \mu\text{A}$	± 20 ± 15 ± 15	± 100	± 150	± 150	ppm/ $^\circ\text{C}$ ppm/ $^\circ\text{C}$ (max) ppm/ $^\circ\text{C}$
		Reverse Breakdown Voltage Change with Operating Current Change	$I_{RMIN} \leq I_R \leq 1 \text{ mA}$ $1 \text{ mA} \leq I_R \leq 15 \text{ mA}$	0.4 2.5	0.8 1.0 6.0 8.0	1.0 1.2 8.0 10.0	1.0 1.2 8.0 10.0	mV mV (max) mV (max) mV mV (max) mV (max)
Z_R	Reverse Dynamic Impedance	$I_R = 1 \text{ mA}$, $f = 120 \text{ Hz}$ $I_{AC} = 0.1 I_R$	0.3	0.9	1.1	1.1	Ω Ω (max)	
e_N	Wideband Noise	$I_R = 100 \mu\text{A}$ $10 \text{ Hz} \leq f \leq 10 \text{ kHz}$	35				μV_{rms}	
ΔV_R	Reverse Breakdown Voltage Long Term Stability	$t = 1000 \text{ hrs}$ $T = 25^\circ\text{C} \pm 0.1^\circ\text{C}$ $I_R = 100 \mu\text{A}$	120				ppm	

LM4040-2.5 Electrical Characteristics (Extended Temperature Range)

Boldface limits apply for $T_A = T_J = T_{MIN}$ to T_{MAX} ; all other limits $T_A = T_J = 25^\circ\text{C}$. The grades C, D and E designate initial Reverse Breakdown Voltage tolerances of ± 0.5 .

Symbol	Parameter	Conditions	Typical (Note 4)	LM4040CEM3 Limits (Note 5)	LM4040DEM3 Limits (Note 5)	LM4040EEM3 Limits (Note 5)	Units (Limit)	
V_R	Reverse Breakdown Voltage	$I_R = 100 \mu\text{A}$	2.500				V	
	Reverse Breakdown Voltage Tolerance (Note 6)	$I_R = 100 \mu\text{A}$		± 12 ± 38	± 25 ± 63	± 50 ± 88	mV (max) mV (max)	
I_{RMIN}	Minimum Operating Current		45	60 68	60 73	60 73	μA μA (max) μA (max)	
		Average Reverse Breakdown Voltage Temperature Coefficient (Note 6)	$I_R = 10 \text{ mA}$	± 20	± 100	± 150	± 150	ppm/ $^\circ\text{C}$
			$I_R = 1 \text{ mA}$	± 15				ppm/ $^\circ\text{C}$ (max)
$\Delta V_R / \Delta I_R$	Reverse Breakdown Voltage Change with Operating Current Change	$I_{RMIN} \leq I_R \leq 1 \text{ mA}$	0.3	0.8 1.0	1.0 1.2	1.0 1.2	mV mV (max) mV (max)	
		$1 \text{ mA} \leq I_R \leq 15 \text{ mA}$	2.5	6.0 8.0	8.0 10.0	8.0 10.0	mV mV (max) mV (max)	
Z_R	Reverse Dynamic Impedance	$I_R = 1 \text{ mA}$, $f = 120 \text{ Hz}$, $I_{AC} = 0.1 I_R$	0.3	0.9	1.1	1.1	Ω Ω (max)	
e_N	Wideband Noise	$I_R = 100 \mu\text{A}$ $10 \text{ Hz} \leq f \leq 10 \text{ kHz}$	35				μV_{rms}	
ΔV_R	Reverse Breakdown Voltage Long Term Stability	$t = 1000 \text{ hrs}$ $T = 25^\circ\text{C} \pm 0.1^\circ\text{C}$ $I_R = 100 \mu\text{A}$	120				ppm	

LM4040-4.1 Electrical Characteristics (Industrial Temperature Range)

Boldface limits apply for $T_A = T_J = T_{MIN}$ to T_{MAX} ; all other limits $T_A = T_J = 25^\circ\text{C}$. The grades A and B designate initial Reverse Breakdown Voltage tolerances of $\pm 0.1\%$ and $\pm 0.2\%$, respectively.

Symbol	Parameter	Conditions	Typical (Note 4)	LM4040AIM3 LM4040AIZ Limits (Note 5)	LM4040BIM3 LM4040BIZ Limits (Note 5)	Units (Limit)
V_R	Reverse Breakdown Voltage	$I_R = 100 \mu\text{A}$	4.096			V
	Reverse Breakdown Voltage Tolerance (Note 6)	$I_R = 100 \mu\text{A}$		± 4.1 ± 31	± 8.2 ± 35	mV (max) mV (max)
I_{RMIN}	Minimum Operating Current		50	68 73	68 73	μA μA (max) μA (max)
$\Delta V_R/\Delta T$	Average Reverse Breakdown Voltage Temperature Coefficient (Note 6)	$I_R = 10 \text{ mA}$	± 30			ppm/ $^\circ\text{C}$
		$I_R = 1 \text{ mA}$	± 20	± 100	± 100	ppm/ $^\circ\text{C}$ (max)
		$I_R = 100 \mu\text{A}$	± 20			ppm/ $^\circ\text{C}$
$\Delta V_R/\Delta I_R$	Reverse Breakdown Voltage Change with Operating Current Change	$I_{RMIN} \leq I_R \leq 1 \text{ mA}$	0.5	0.9 1.2	0.9 1.2	mV mV (max) mV (max)
		$1 \text{ mA} \leq I_R \leq 15 \text{ mA}$	3.0	7.0 10.0	7.0 10.0	mV mV (max) mV (max)
Z_R	Reverse Dynamic Impedance	$I_R = 1 \text{ mA}$, $f = 120 \text{ Hz}$, $I_{AC} = 0.1 I_R$	0.5	1.0	1.0	Ω Ω (max)
e_N	Wideband Noise	$I_R = 100 \mu\text{A}$ $10 \text{ Hz} \leq f \leq 10 \text{ kHz}$	80			μV_{rms}
ΔV_R	Reverse Breakdown Voltage Long Term Stability	$t = 1000 \text{ hrs}$ $T = 25^\circ\text{C} \pm 0.1^\circ\text{C}$ $I_R = 100 \mu\text{A}$	120			ppm

LM4040-4.1 Electrical Characteristics (Industrial Temperature Range)

Boldface limits apply for $T_A = T_J = T_{MIN}$ to T_{MAX} ; all other limits $T_A = T_J = 25^\circ\text{C}$. The grades C and D designate initial Reverse Breakdown Voltage tolerances of $\pm 0.5\%$ and $\pm 1.0\%$, respectively.

Symbol	Parameter	Conditions	Typical (Note 4)	LM4040CIM3 LM4040CIZ Limits (Note 5)	LM4040DIM3 LM4040DIZ Limits (Note 5)	Units (Limit)
V_R	Reverse Breakdown Voltage	$I_R = 100 \mu\text{A}$	4.096			V
	Reverse Breakdown Voltage Tolerance (Note 6)	$I_R = 100 \mu\text{A}$		± 20 ± 47	± 41 ± 81	mV (max) mV (max)
I_{RMIN}	Minimum Operating Current		50	68 73	73 78	μA μA (max) μA (max)
$\Delta V_R/\Delta T$	Average Reverse Breakdown Voltage Temperature Coefficient (Note 6)	$I_R = 10 \text{ mA}$	± 30			ppm/ $^\circ\text{C}$
		$I_R = 1 \text{ mA}$	± 20	± 100	± 150	ppm/ $^\circ\text{C}$ (max)
		$I_R = 100 \mu\text{A}$	± 20			ppm/ $^\circ\text{C}$
$\Delta V_R/\Delta I_R$	Reverse Breakdown Voltage Change with Operating Current Change	$I_{RMIN} \leq I_R \leq 1 \text{ mA}$	0.5	0.9 1.2	1.2 1.5	mV mV (max) mV (max)
		$1 \text{ mA} \leq I_R \leq 15 \text{ mA}$	3.0	7.0 10.0	9.0 13.0	mV mV (max) mV (max)
Z_R	Reverse Dynamic Impedance	$I_R = 1 \text{ mA}$, $f = 120 \text{ Hz}$, $I_{AC} = 0.1 I_R$	0.5	1.0	1.3	Ω Ω (max)
e_N	Wideband Noise	$I_R = 100 \mu\text{A}$ $10 \text{ Hz} \leq f \leq 10 \text{ kHz}$	80			μV_{rms}
ΔV_R	Reverse Breakdown Voltage Long Term Stability	$t = 1000 \text{ hrs}$ $T = 25^\circ\text{C} \pm 0.1^\circ\text{C}$ $I_R = 100 \mu\text{A}$	120			ppm

LM4040-5.0 Electrical Characteristics (Industrial Temperature Range)

Boldface limits apply for $T_A = T_J = T_{MIN}$ to T_{MAX} ; all other limits $T_A = T_J = 25^\circ\text{C}$. The grades A and B designate initial Reverse Breakdown Voltage tolerances of $\pm 0.1\%$ and $\pm 0.2\%$, respectively.

Symbol	Parameter	Conditions	Typical (Note 4)	LM4040AIM3 LM4040AIZ Limits (Note 5)	LM4040BIM3 LM4040BIZ Limits (Note 5)	Units (Limit)
V_R	Reverse Breakdown Voltage	$I_R = 100 \mu\text{A}$	5.000			V
	Reverse Breakdown Voltage Tolerance (Note 6)	$I_R = 100 \mu\text{A}$		± 5.0 ± 38	± 10 ± 43	mV (max) mV (max)
I_{RMIN}	Minimum Operating Current		54	74 80	74 80	μA μA (max) μA (max)
$\Delta V_R/\Delta T$	Average Reverse Breakdown Voltage Temperature Coefficient (Note 6)	$I_R = 10 \text{ mA}$	± 30			ppm/ $^\circ\text{C}$
		$I_R = 1 \text{ mA}$	± 20	± 100	± 100	ppm/ $^\circ\text{C}$ (max)
		$I_R = 100 \mu\text{A}$	± 20			ppm/ $^\circ\text{C}$
$\Delta V_R/\Delta I_R$	Reverse Breakdown Voltage Change with Operating Current Change	$I_{RMIN} \leq I_R \leq 1 \text{ mA}$	0.5	1.0 1.4	1.0 1.4	mV mV (max) mV (max)
		$1 \text{ mA} \leq I_R \leq 15 \text{ mA}$	3.5	8.0 12.0	8.0 12.0	mV mV (max) mV (max)
Z_R	Reverse Dynamic Impedance	$I_R = 1 \text{ mA}$, $f = 120 \text{ Hz}$, $I_{AC} = 0.1 I_R$	0.5	1.1	1.1	Ω Ω (max)
e_N	Wideband Noise	$I_R = 100 \mu\text{A}$ $10 \text{ Hz} \leq f \leq 10 \text{ kHz}$	80			μV_{rms}
ΔV_R	Reverse Breakdown Voltage Long Term Stability	$t = 1000 \text{ hrs}$ $T = 25^\circ\text{C} \pm 0.1^\circ\text{C}$ $I_R = 100 \mu\text{A}$	120			ppm

LM4040-5.0 Electrical Characteristics (Industrial Temperature Range)

Boldface limits apply for $T_A = T_J = T_{MIN}$ to T_{MAX} ; all other limits $T_A = T_J = 25^\circ\text{C}$. The grades C and D designate initial Reverse Breakdown Voltage tolerances of $\pm 0.5\%$ and $\pm 1.0\%$, respectively.

Symbol	Parameter	Conditions	Typical (Note 4)	LM4040CIM3 LM4040CIZ Limits (Note 5)	LM4040DIM3 LM4040DIZ Limits (Note 5)	Units (Limit)
V_R	Reverse Breakdown Voltage	$I_R = 100 \mu\text{A}$	5.000			V
	Reverse Breakdown Voltage Tolerance (Note 6)	$I_R = 100 \mu\text{A}$		± 25 ± 58	± 50 ± 99	mV (max) mV (max)
I_{RMIN}	Minimum Operating Current		54	74 80	79 85	μA μA (max) μA (max)
$\Delta V_R/\Delta T$	Average Reverse Breakdown Voltage Temperature Coefficient (Note 6)	$I_R = 10 \text{ mA}$	± 30			ppm/ $^\circ\text{C}$
		$I_R = 1 \text{ mA}$	± 20	± 100	± 150	ppm/ $^\circ\text{C}$ (max)
		$I_R = 100 \mu\text{A}$	± 20			ppm/ $^\circ\text{C}$
$\Delta V_R/\Delta I_R$	Reverse Breakdown Voltage Change with Operating Current Change	$I_{RMIN} \leq I_R \leq 1 \text{ mA}$	0.5	1.0 1.4	1.3 1.8	mV mV (max) mV (max)
		$1 \text{ mA} \leq I_R \leq 15 \text{ mA}$	3.5	8.0 12.0	10.0 15.0	mV mV (max) mV (max)
Z_R	Reverse Dynamic Impedance	$I_R = 1 \text{ mA}$, $f = 120 \text{ Hz}$, $I_{AC} = 0.1 I_R$	0.5	1.1	1.5	Ω Ω (max)
e_N	Wideband Noise	$I_R = 100 \mu\text{A}$ $10 \text{ Hz} \leq f \leq 10 \text{ kHz}$	80			μV_{rms}
ΔV_R	Reverse Breakdown Voltage Long Term Stability	$t = 1000 \text{ hrs}$ $T = 25^\circ\text{C} \pm 0.1^\circ\text{C}$ $I_R = 100 \mu\text{A}$	120			ppm

LM4040-5.0 Electrical Characteristics (Extended Temperature Range)

Boldface limits apply for $T_A = T_J = T_{MIN}$ to T_{MAX} ; all other limits $T_A = T_J = 25^\circ\text{C}$. The grades C and D designate initial Reverse Breakdown Voltage tolerances of $\pm 0.5\%$ and $\pm 1.0\%$, respectively.

Symbol	Parameter	Conditions	Typical (Note 4)	LM4040CEM3 Limits (Note 5)	LM4040DEM3 Limits (Note 5)	Units (Limit)
V_R	Reverse Breakdown Voltage	$I_R = 100 \mu\text{A}$	5.000			V
	Reverse Breakdown Voltage Tolerance (Note 6)	$I_R = 100 \mu\text{A}$		± 25 ± 75	± 50 ± 125	mV (max) mV (max)
I_{RMIN}	Minimum Operating Current		54	74 83	79 88	μA μA (max) μA (max)
$\Delta V_R / \Delta T$	Average Reverse Breakdown Voltage Temperature Coefficient (Note 6)	$I_R = 10 \text{ mA}$	± 30			ppm/ $^\circ\text{C}$
		$I_R = 1 \text{ mA}$	± 20	± 100	± 150	ppm/ $^\circ\text{C}$ (max)
		$I_R = 100 \mu\text{A}$	± 20			ppm/ $^\circ\text{C}$
$\Delta V_R / \Delta I_R$	Reverse Breakdown Voltage Change with Operating Current Change	$I_{RMIN} \leq I_R \leq 1 \text{ mA}$	0.5	1.0 1.4	1.0 1.8	mV mV (max) mV (max)
		$1 \text{ mA} \leq I_R \leq 15 \text{ mA}$	3.5	8.0 12.0	8.0 15.0	mV mV (max) mV (max)
Z_R	Reverse Dynamic Impedance	$I_R = 1 \text{ mA}$, $f = 120 \text{ Hz}$, $I_{AC} = 0.1 I_R$	0.5	1.1	1.1	Ω Ω (max)
e_N	Wideband Noise	$I_R = 100 \mu\text{A}$ $10 \text{ Hz} \leq f \leq 10 \text{ kHz}$	80			μV_{rms}
ΔV_R	Reverse Breakdown Voltage Long Term Stability	$t = 1000 \text{ hrs}$ $T = 25^\circ\text{C} \pm 0.1^\circ\text{C}$ $I_R = 100 \mu\text{A}$	120			ppm

LM4040-8.2 Electrical Characteristics (Industrial Temperature Range)

Boldface limits apply for $T_A = T_J = T_{MIN}$ to T_{MAX} ; all other limits $T_A = T_J = 25^\circ\text{C}$. The grades A and B designate initial Reverse Breakdown Voltage tolerances of $\pm 0.1\%$ and $\pm 0.2\%$, respectively.

Symbol	Parameter	Conditions	Typical (Note 4)	LM4040AIM3 LM4040AIZ Limits (Note 5)	LM4040BIM3 LM4040BIZ Limits (Note 5)	Units (Limit)
V_R	Reverse Breakdown Voltage	$I_R = 150 \mu\text{A}$	8.192			V
	Reverse Breakdown Voltage Tolerance (Note 6)	$I_R = 150 \mu\text{A}$		± 8.2 ± 61	± 16 ± 70	mV (max) mV (max)
I_{RMIN}	Minimum Operating Current		67	91 95	91 95	μA μA (max) μA (max)
$\Delta V_R/\Delta T$	Average Reverse Breakdown Voltage Temperature Coefficient (Note 6)	$I_R = 10 \text{ mA}$	± 40			ppm/ $^\circ\text{C}$
		$I_R = 1 \text{ mA}$	± 20	± 100	± 100	ppm/ $^\circ\text{C}$ (max)
		$I_R = 150 \mu\text{A}$	± 20			ppm/ $^\circ\text{C}$
$\Delta V_R/\Delta I_R$	Reverse Breakdown Voltage Change with Operating Current Change	$I_{RMIN} \leq I_R \leq 1 \text{ mA}$	0.6	1.3 2.5	1.3 2.5	mV mV (max) mV (max)
		$1 \text{ mA} \leq I_R \leq 15 \text{ mA}$	7.0	10.0 18.0	10.0 18.0	mV mV (max) mV (max)
Z_R	Reverse Dynamic Impedance	$I_R = 1 \text{ mA}$, $f = 120 \text{ Hz}$, $I_{AC} = 0.1 I_R$	0.6	1.5	1.5	Ω Ω (max)
e_N	Wideband Noise	$I_R = 150 \mu\text{A}$ $10 \text{ Hz} \leq f \leq 10 \text{ kHz}$	130			μV_{rms}
ΔV_R	Reverse Breakdown Voltage Long Term Stability	$t = 1000 \text{ hrs}$ $T = 25^\circ\text{C} \pm 0.1^\circ\text{C}$ $I_R = 150 \mu\text{A}$	120			ppm

LM4040-8.2 Electrical Characteristics (Industrial Temperature Range)

Boldface limits apply for $T_A = T_J = T_{MIN}$ to T_{MAX} ; all other limits $T_A = T_J = 25^\circ\text{C}$. The grades C and D designate initial Reverse Breakdown Voltage tolerances of $\pm 0.5\%$ and $\pm 1.0\%$, respectively.

Symbol	Parameter	Conditions	Typical (Note 4)	LM4040CIM3 LM4040CIZ Limits (Note 5)	LM4040DIM3 LM4040DIZ Limits (Note 5)	Units (Limit)
V_R	Reverse Breakdown Voltage	$I_R = 150 \mu\text{A}$	8.192			V
	Reverse Breakdown Voltage Tolerance (Note 6)	$I_R = 150 \mu\text{A}$		± 41 ± 94	± 82 ± 162	mV (max) mV (max)
I_{RMIN}	Minimum Operating Current		67	91 95	96 100	μA μA (max) μA (max)
$\Delta V_R/\Delta T$	Average Reverse Breakdown Voltage Temperature Coefficient (Note 6)	$I_R = 10 \text{ mA}$	± 40			ppm/ $^\circ\text{C}$
		$I_R = 1 \text{ mA}$	± 20	± 100	± 150	ppm/ $^\circ\text{C}$ (max)
		$I_R = 150 \mu\text{A}$	± 20			ppm/ $^\circ\text{C}$
$\Delta V_R/\Delta I_R$	Reverse Breakdown Voltage Change with Operating Current Change	$I_{RMIN} \leq I_R \leq 1 \text{ mA}$	0.6	1.3 2.5	1.7 3.0	mV mV (max) mV (max)
		$1 \text{ mA} \leq I_R \leq 15 \text{ mA}$	7.0	10.0 18.0	15.0 24.0	mV mV (max) mV (max)
Z_R	Reverse Dynamic Impedance	$I_R = 1 \text{ mA}$, $f = 120 \text{ Hz}$, $I_{AC} = 0.1 I_R$	0.6	1.5	1.9	Ω Ω (max)
e_N	Wideband Noise	$I_R = 150 \mu\text{A}$ $10 \text{ Hz} \leq f \leq 10 \text{ kHz}$	130			μV_{rms}
ΔV_R	Reverse Breakdown Voltage Long Term Stability	$t = 1000 \text{ hrs}$ $T = 25^\circ\text{C} \pm 0.1^\circ\text{C}$ $I_R = 150 \mu\text{A}$	120			ppm

LM4040-10.0 Electrical Characteristics (Industrial Temperature Range)

Boldface limits apply for $T_A = T_J = T_{MIN}$ to T_{MAX} ; all other limits $T_A = T_J = 25^\circ\text{C}$. The grades A and B designate initial Reverse Breakdown Voltage tolerances of $\pm 0.1\%$ and $\pm 0.2\%$, respectively.

Symbol	Parameter	Conditions	Typical (Note 4)	LM4040AIM3 LM4040AIZ Limits (Note 5)	LM4040BIM3 LM4040BIZ Limits (Note 5)	Units (Limit)
V_R	Reverse Breakdown Voltage	$I_R = 150 \mu\text{A}$	10.00			V
	Reverse Breakdown Voltage Tolerance (Note 6)	$I_R = 150 \mu\text{A}$		± 10 ± 75	± 20 ± 85	mV (max) mV (max)
I_{RMIN}	Minimum Operating Current		75	100 103	100 103	μA μA (max) μA (max)
$\Delta V_R/\Delta T$	Average Reverse Breakdown Voltage Temperature Coefficient (Note 6)	$I_R = 10 \text{ mA}$	± 40	± 100	± 100	ppm/ $^\circ\text{C}$
		$I_R = 1 \text{ mA}$	± 20			ppm/ $^\circ\text{C}$ (max)
		$I_R = 150 \mu\text{A}$	± 20			ppm/ $^\circ\text{C}$
$\Delta V_R/\Delta I_R$	Reverse Breakdown Voltage Change with Operating Current Change	$I_{RMIN} \leq I_R \leq 1 \text{ mA}$	0.8	1.5 3.5	1.5 3.5	mV mV (max) mV (max)
		$1 \text{ mA} \leq I_R \leq 15 \text{ mA}$	8.0	12.0 23.0	12.0 23.0	mV mV (max) mV (max)
Z_R	Reverse Dynamic Impedance	$I_R = 1 \text{ mA}$, $f = 120 \text{ Hz}$, $I_{AC} = 0.1 I_R$	0.7	1.7	1.7	Ω Ω (max)
e_N	Wideband Noise	$I_R = 150 \mu\text{A}$ $10 \text{ Hz} \leq f \leq 10 \text{ kHz}$	180			μV_{rms}
ΔV_R	Reverse Breakdown Voltage Long Term Stability	$t = 1000 \text{ hrs}$ $T = 25^\circ\text{C} \pm 0.1^\circ\text{C}$ $I_R = 150 \mu\text{A}$	120			ppm

LM4040-10.0

Electrical Characteristics (Industrial Temperature Range)

Boldface limits apply for $T_A = T_J = T_{MIN}$ to T_{MAX} ; all other limits $T_A = T_J = 25^\circ\text{C}$. The grades C and D designate initial Reverse Breakdown Voltage tolerances of $\pm 0.5\%$ and $\pm 1.0\%$, respectively.

Symbol	Parameter	Conditions	Typical (Note 4)	LM4040CIM3 LM4040CIZ Limits (Note 5)	LM4040DIM3 LM4040DIZ Limits (Note 5)	Units (Limit)
V_R	Reverse Breakdown Voltage	$I_R = 150 \mu\text{A}$	10.00			V
	Reverse Breakdown Voltage Tolerance (Note 6)	$I_R = 150 \mu\text{A}$		± 50 ± 115	± 100 ± 198	mV (max) mV (max)
I_{RMIN}	Minimum Operating Current		75	100 103	110 113	μA μA (max) μA (max)
$\Delta V_R/\Delta T$	Average Reverse Breakdown Voltage Temperature Coefficient (Note 6)	$I_R = 10 \text{ mA}$	± 40			ppm/ $^\circ\text{C}$
		$I_R = 1 \text{ mA}$	± 20	± 100	± 150	ppm/ $^\circ\text{C}$ (max)
		$I_R = 150 \mu\text{A}$	± 20			ppm/ $^\circ\text{C}$
$\Delta V_R/\Delta I_R$	Reverse Breakdown Voltage Change with Operating Current Change	$I_{RMIN} \leq I_R \leq 1 \text{ mA}$	0.8	1.5 3.5	2.0 4.0	mV mV (max) mV (max)
		$1 \text{ mA} \leq I_R \leq 15 \text{ mA}$	8.0	12.0 23.0	18.0 29.0	mV mV (max) mV (max)
Z_R	Reverse Dynamic Impedance	$I_R = 1 \text{ mA}$, $f = 120 \text{ Hz}$, $I_{AC} = 0.1 I_R$	0.7	1.7	2.3	Ω Ω (max)
e_N	Wideband Noise	$I_R = 150 \mu\text{A}$ $10 \text{ Hz} \leq f \leq 10 \text{ kHz}$	180			μV_{rms}
ΔV_R	Reverse Breakdown Voltage Long Term Stability	$t = 1000 \text{ hrs}$ $T = 25^\circ\text{C} \pm 0.1^\circ\text{C}$ $I_R = 150 \mu\text{A}$	120			ppm

Electrical Characteristics(Notes)

Note 1: Absolute Maximum Ratings indicate limits beyond which damage to the device may occur. Operating Ratings indicate conditions for which the device is functional, but do not guarantee specific performance limits. For guaranteed specifications and test conditions, see the Electrical Characteristics. The guaranteed specifications apply only for the test conditions listed. Some performance characteristics may degrade when the device is not operated under the listed test conditions.

Note 2: The maximum power dissipation must be derated at elevated temperatures and is dictated by T_{Jmax} (maximum junction temperature), θ_{JA} (junction to ambient thermal resistance), and T_A (ambient temperature). The maximum allowable power dissipation at any temperature is $PD_{max} = (T_{Jmax} - T_A)/\theta_{JA}$ or the number given in the Absolute Maximum Ratings, whichever is lower. For the LM4040, $T_{Jmax} = 125^\circ\text{C}$, and the typical thermal resistance (θ_{JA}), when board mounted, is 326°C/W for the SOT-23 package, and 180°C/W with $0.4''$ lead length and 170°C/W with $0.125''$ lead length for the TO-92 package.

Note 3: The human body model is a 100 pF capacitor discharged through a $1.5\text{ k}\Omega$ resistor into each pin. The machine model is a 200 pF capacitor discharged directly into each pin.

Note 4: Typicals are at $T_J = 25^\circ\text{C}$ and represent most likely parametric norm.

Note 5: Limits are 100% production tested at 25°C . Limits over temperature are guaranteed through correlation using Statistical Quality Control (SQC) methods. The limits are used to calculate National's AOQL.

Note 6: The boldface (over-temperature) limit for Reverse Breakdown Voltage Tolerance is defined as the room temperature Reverse Breakdown Voltage Tolerance $\pm[(\Delta V_R/\Delta T)(\max\Delta T)(V_R)]$. Where, $\Delta V_R/\Delta T$ is the V_R temperature coefficient, $\max\Delta T$ is the maximum difference in temperature from the reference point of 25°C to T_{MIN} or T_{MAX} , and V_R is the reverse breakdown voltage. The total over-temperature tolerance for the different grades in the industrial temperature range where $\max\Delta T = 65^\circ\text{C}$ is shown below:

A-grade: $\pm 0.75\% = \pm 0.1\% \pm 100\text{ ppm}/^\circ\text{C} \times 65^\circ\text{C}$

B-grade: $\pm 0.85\% = \pm 0.2\% \pm 100\text{ ppm}/^\circ\text{C} \times 65^\circ\text{C}$

C-grade: $\pm 1.15\% = \pm 0.5\% \pm 100\text{ ppm}/^\circ\text{C} \times 65^\circ\text{C}$

D-grade: $\pm 1.98\% = \pm 1.0\% \pm 150\text{ ppm}/^\circ\text{C} \times 65^\circ\text{C}$

E-grade: $\pm 2.98\% = \pm 2.0\% \pm 150\text{ ppm}/^\circ\text{C} \times 65^\circ\text{C}$

The total over-temperature tolerance for the different grades in the extended temperature range where $\max\Delta T = 100^\circ\text{C}$ is shown below:

C-grade: $\pm 1.5\% = \pm 0.5\% \pm 100\text{ ppm}/^\circ\text{C} \times 100^\circ\text{C}$

D-grade: $\pm 2.5\% = \pm 1.0\% \pm 150\text{ ppm}/^\circ\text{C} \times 100^\circ\text{C}$

E-grade: $\pm 4.5\% = \pm 2.0\% \pm 150\text{ ppm}/^\circ\text{C} \times 100^\circ\text{C}$

Therefore, as an example, the A-grade LM4040-2.5 has an over-temperature Reverse Breakdown Voltage tolerance of $\pm 2.5\text{V} \times 0.75\% = \pm 19\text{ mV}$.

Typical Performance Characteristics

Temperature Drift for Different Average Temperature Coefficient

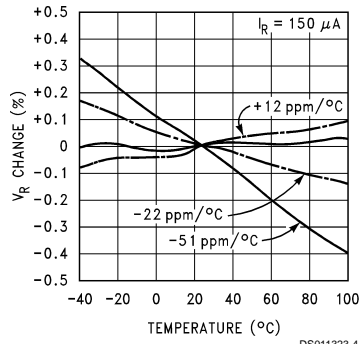

DS011323-4

Output Impedance vs Frequency

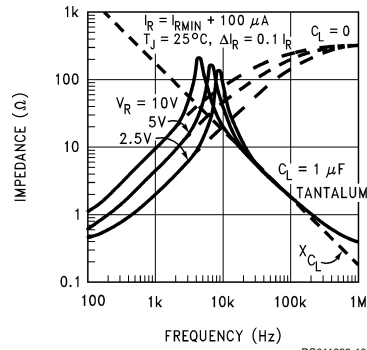

DS011323-10

Output Impedance vs Frequency

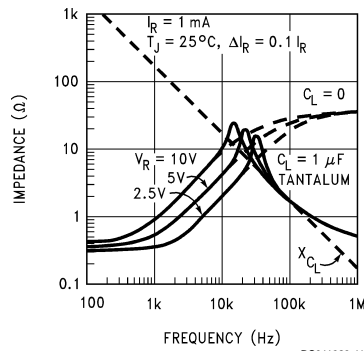

DS011323-11

Reverse Characteristics and Minimum Operating Current

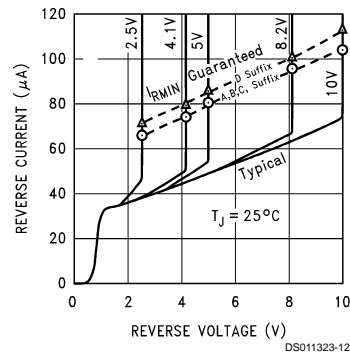

DS011323-12

Noise Voltage vs Frequency

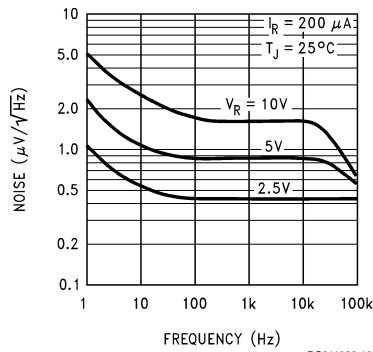

DS011323-13

Start-Up Characteristics

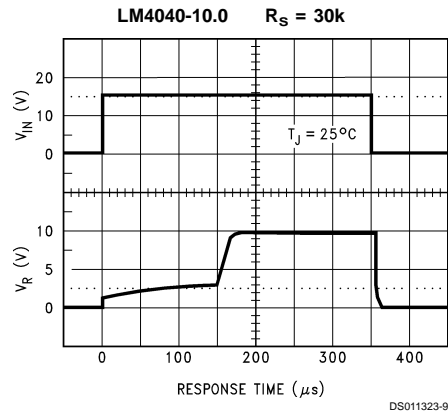
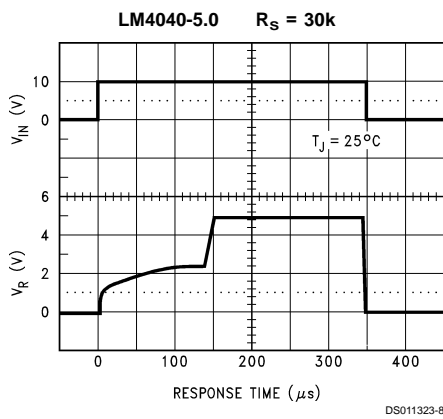
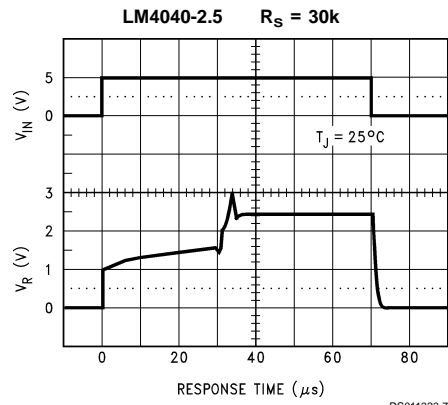
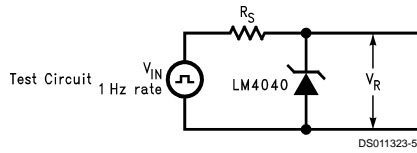

Functional Block Diagram

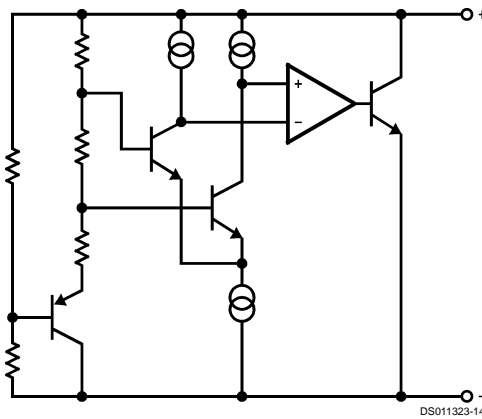

Applications Information

The LM4040 is a precision micro-power curvature-corrected bandgap shunt voltage reference. For space critical applications, the LM4040 is available in the sub-miniature SOT-23 surface-mount package. The LM4040 has been designed for stable operation without the need of an external capacitor connected between the "+" pin and the "-" pin. If, however, a bypass capacitor is used, the LM4040 remains stable. Reducing design effort is the availability of several fixed reverse breakdown voltages: 2.500V, 4.096V, 5.000V, 6.000, 8.192V, and 10.000V. The minimum operating current increases from 60 μ A for the LM4040-2.5 to 100 μ A for the LM4040-10.0. All versions have a maximum operating current of 15 mA.

LM4040s in the SOT-23 packages have a parasitic Schottky diode between pin 2 (-) and pin 3 (Die attach interface contact). Therefore, pin 3 of the SOT-23 package must be left floating or connected to pin 2.

The 4.096V version allows single +5V 12-bit ADCs or DACs to operate with an LSB equal to 1 mV. For 12-bit ADCs or DACs that operate on supplies of 10V or greater, the 8.192V version gives 2 mV per LSB.

In a conventional shunt regulator application (*Figure 1*), an external series resistor (R_S) is connected between the supply voltage and the LM4040. R_S determines the current that flows through the load (I_L) and the LM4040 (I_Q). Since load current and supply voltage may vary, R_S should be small enough to supply at least the minimum acceptable I_Q to the

LM4040 even when the supply voltage is at its minimum and the load current is at its maximum value. When the supply voltage is at its maximum and I_L is at its minimum, R_S should be large enough so that the current flowing through the LM4040 is less than 15 mA.

R_S is determined by the supply voltage, (V_S), the load and operating current, (I_L and I_Q), and the LM4040's reverse breakdown voltage, V_R .

$$R_S = \frac{V_S - V_R}{I_L + I_Q}$$

Typical Applications

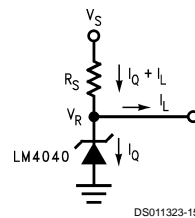

DS011323-15
FIGURE 1. Shunt Regulator

Typical Applications (Continued)

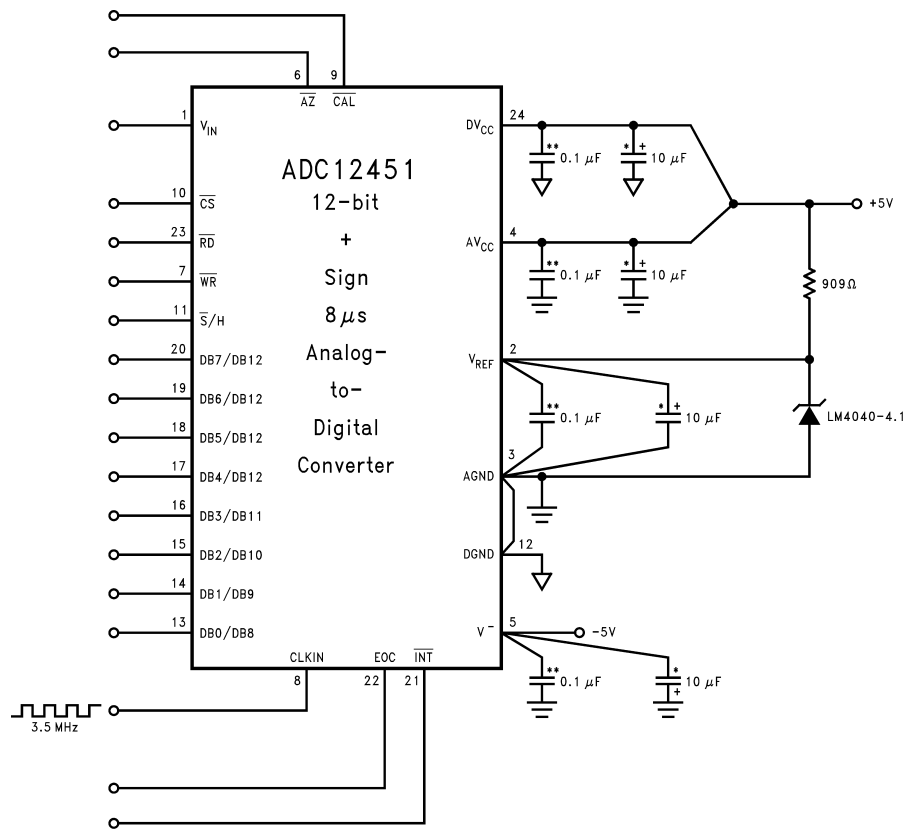

**Ceramic monolithic
*Tantalum

DS011323-16

FIGURE 2. LM4040-4.1's Nominal 4.096 breakdown voltage gives ADC12451 1 mV/LSB

Typical Applications (Continued)

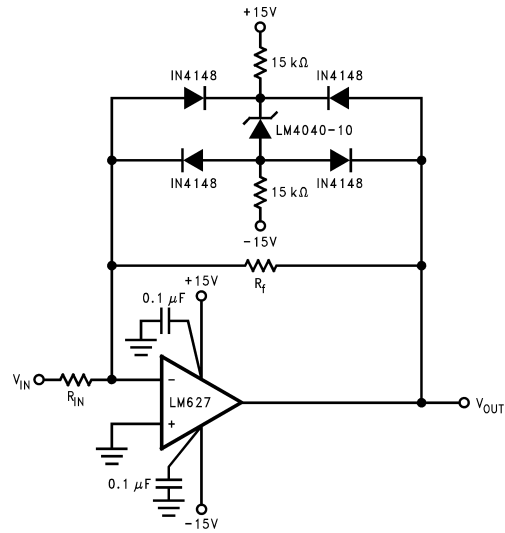

DS011323-17

FIGURE 3. Bounded amplifier reduces saturation-induced delays and can prevent succeeding stage damage. Nominal clamping voltage is $\pm 11.5V$ (LM4040's reverse breakdown voltage +2 diode V_f).

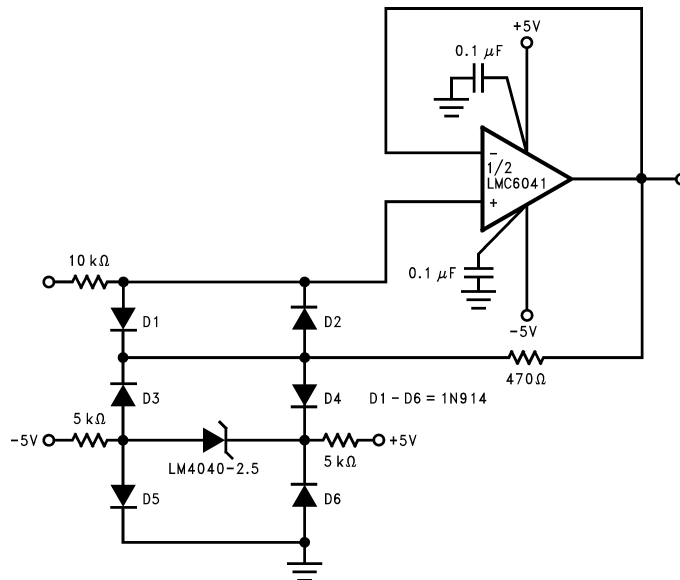

DS011323-18

FIGURE 4. Protecting Op Amp input. The bounding voltage is $\pm 4V$ with the LM4040-2.5 (LM4040's reverse breakdown voltage + 3 diode V_f).

Typical Applications (Continued)

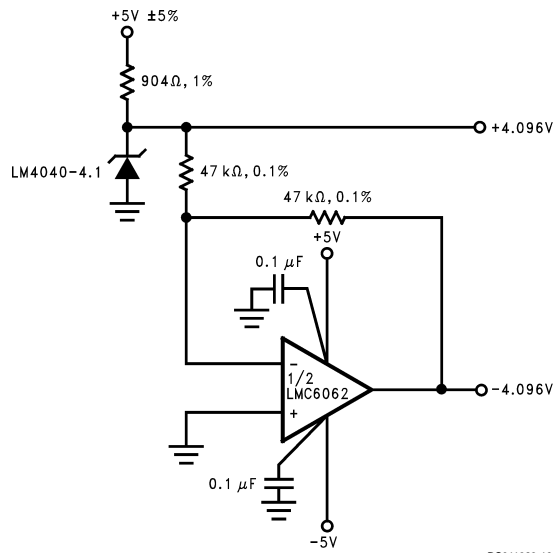

DS011323-19

FIGURE 5. Precision ±4.096V Reference

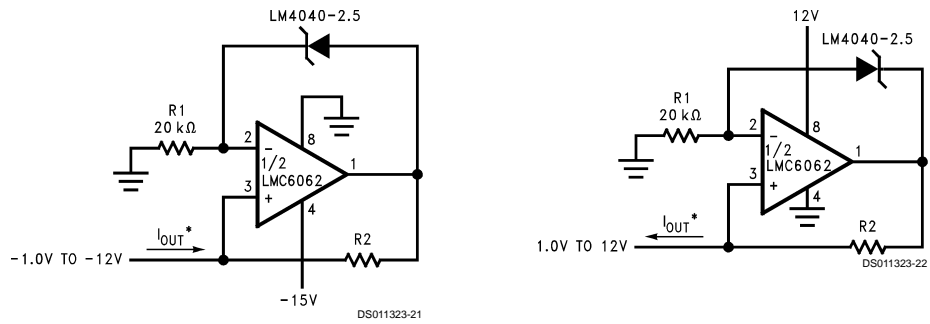

DS011323-22

$$I_{OUT}^* = \frac{2.5V}{R_2}$$

FIGURE 6. Precision 1 μA to 1 mA Current Sources

Physical Dimensions inches (millimeters) unless otherwise noted

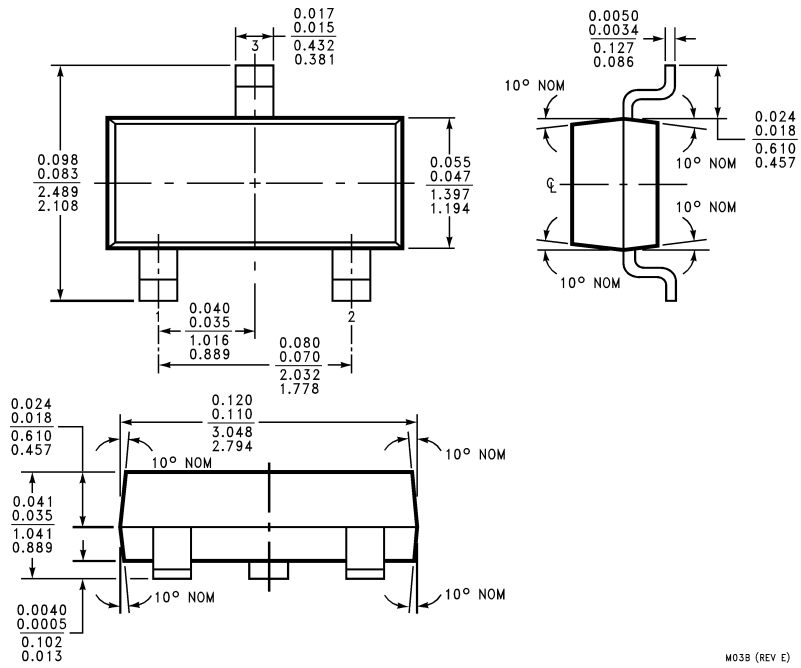

Plastic Surface Mount Package (M3)
NS Package Number M03B
(JEDEC Registration TO-236AB)

M03B (REV E)

Physical Dimensions inches (millimeters) unless otherwise noted (Continued)

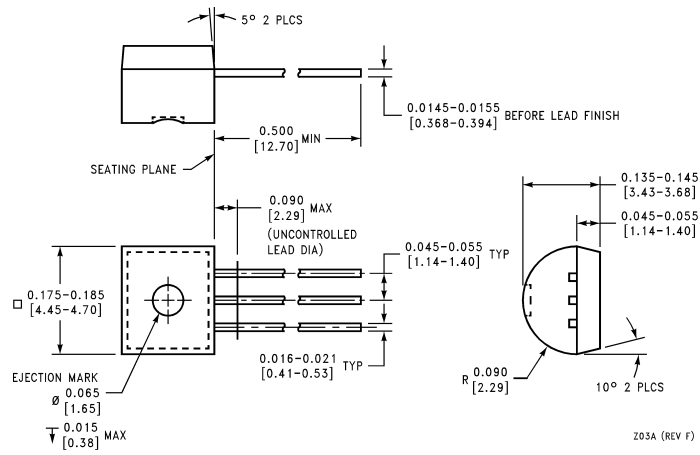

**Plastic Package (Z)
NS Package Number Z03A**

Z03A (REV F)

LIFE SUPPORT POLICY

NATIONAL'S PRODUCTS ARE NOT AUTHORIZED FOR USE AS CRITICAL COMPONENTS IN LIFE SUPPORT DEVICES OR SYSTEMS WITHOUT THE EXPRESS WRITTEN APPROVAL OF THE PRESIDENT OF NATIONAL SEMICONDUCTOR CORPORATION. As used herein:

1. Life support devices or systems are devices or systems which, (a) are intended for surgical implant into the body, or (b) support or sustain life, and whose failure to perform when properly used in accordance with instructions for use provided in the labeling, can be reasonably expected to result in a significant injury to the user.
2. A critical component in any component of a life support device or system whose failure to perform can be reasonably expected to cause the failure of the life support device or system, or to affect its safety or effectiveness.



National Semiconductor Corporation
Americas
Tel: 1-800-272-9959
Fax: 1-800-737-7018
Email: support@nsc.com

National Semiconductor Europe
Fax: +49 (0) 1 80-530 85 86
Email: europe.support@nsc.com
Deutsch Tel: +49 (0) 1 80-530 85 85
English Tel: +49 (0) 1 80-532 78 32
Français Tel: +49 (0) 1 80-532 93 58
Italiano Tel: +49 (0) 1 80-534 16 80

National Semiconductor Asia Pacific Customer Response Group
Tel: 65-2544466
Fax: 65-2504466
Email: sea.support@nsc.com

National Semiconductor Japan Ltd.
Tel: 81-3-5620-6175
Fax: 81-3-5620-6179

www.national.com

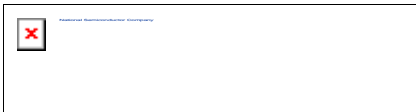

LM4040 Precision Micropower Shunt Voltage Reference

See Also: [LM4050](#) - Lower temperature coefficient
[LM4120](#) - Series type reference, lower temperature coefficient

Generic P/N 4040

Contents

- [General Description](#)
- [Features](#)
- [Applications](#)
- [Datasheet](#)
- [Package Availability, Models, Samples & Pricing](#)

Parametric Table	
Output Current, max (Amp)	.0150
Reference Voltage	10 V,2.5 V,4.096 V,5 V,8.192 V
Initial Accuracy (+/-), max(%) (%)	.10,.20,.50,1,2
Tempco, max (ppm/C) (ppm)	100,150
Operating Current, (mA) (mA)	.10,.06,.0680,.0740,.0910

General Description

Ideal for space critical applications, the LM4040 precision voltage reference is available in the sub-miniature (3 mm x 1.3 mm) SOT-23 surface-mount package. The LM4040's advanced design eliminates the need for an external stabilizing capacitor while ensuring stability with any capacitive load, thus making the LM4040 easy to use. Further reducing design effort is the availability of several fixed reverse breakdown voltages: 2.500V, 4.096V, 5.000V, 8.192V, and 10.000V. The minimum operating current increases from 60 μ A for the LM4040-2.5 to 100 μ A for the LM4040-10.0. All versions have a maximum operating current of 15 mA.

The LM4040 utilizes fuse and zener-zap reverse breakdown voltage trim during wafer sort to ensure that the prime parts have an accuracy of better than $\pm 0.1\%$ (A grade) at 25°C. Bandgap reference temperature drift curvature correction and low dynamic impedance ensure stable reverse breakdown voltage accuracy over a wide range of operating temperatures and currents.

Also available is the LM4041 with two reverse breakdown voltage versions: adjustable and 1.2V. Please see the LM4041 data sheet.



Features

- Small packages: SOT-23, TO-92
 - No output capacitor required
 - Tolerates capacitive loads
 - Fixed reverse breakdown voltages of 2.500V, 4.096V, 5.000V, 8.192V, and 10.000V
-

Applications

- Portable, Battery-Powered Equipment
 - Data Acquisition Systems
 - Instrumentation
 - Process Control
 - Energy Management
 - Product Testing
 - Automotive
 - Precision Audio Components
-









Datasheet













Title	Size (in Kbytes)	Date	 View Online	 Download	 Receive via Email
LM4040 Precision Micropower Shunt Voltage Reference	248 Kbytes	14-Sep-98	View Online	Download	Receive via Email







LM4040 Precision Micropower Shunt Voltage Reference (JAPANESE)	344 Kbytes			
				







Please use [Adobe Acrobat](#) to view PDF file(s).
If you have trouble printing, see [Printing Problems](#).

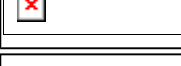
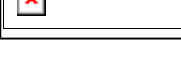

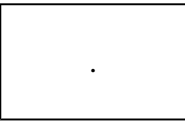
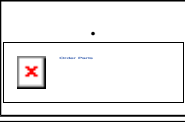
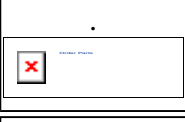
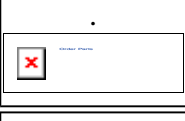

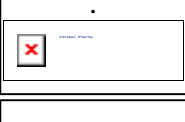
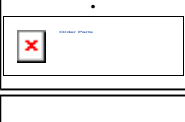



Package Availability, Models, Samples & Pricing







Part Number	Package		Status	Models		Samples & Electronic Orders	Budgetary Pricing		Std Pack Size	Package Marking
	Type	# pins		SPICE	IBIS		Quantity	\$US each		
LM4040AIM3-10.0	SOT-23	3	Full production	N/A	N/A		1K+	\$1.3000	reel of 1000	R0A ø1øT
LM4040AIM3-2.5	SOT-23	3	Full production	N/A	N/A		1K+	\$1.3000	reel of 1000	R2A ø1øT
LM4040AIM3-4.1	SOT-23	3	Full production	N/A	N/A		1K+	\$1.3000	reel of 1000	R4A ø1øT
LM4040AIM3-5.0	SOT-23	3	Full production	N/A	N/A		1K+	\$1.3000	reel of 1000	R5A ø1øT
LM4040AIM3-8.2	SOT-23	3	Full production	N/A	N/A		1K+	\$1.3000	reel of 1000	R8A ø1øT
LM4040BIM3-10.0	SOT-23	3	Full production	N/A	N/A		1K+	\$0.8800	reel of 1000	R0B ø1øT
LM4040BIM3-2.5	SOT-23	3	Full production	N/A	N/A		1K+	\$0.8800	reel of 1000	R2B ø1øT
LM4040BIM3-4.1	SOT-23	3	Full production	N/A	N/A		1K+	\$0.8800	reel of 1000	R4B ø1øT



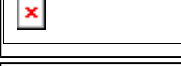
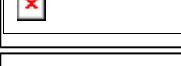
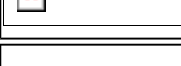
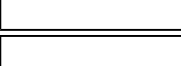
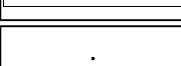
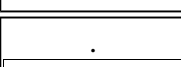

LM4040BIM3-5.0	SOT-23	3	Full production	N/A	N/A		1K+	\$0.8800	reel of 1000	R5B ¢1¢T
LM4040BIM3-8.2	SOT-23	3	Full production	N/A	N/A		1K+	\$0.8800	reel of 1000	R8B ¢1¢T
LM4040CIM3-10.0	SOT-23	3	Full production	N/A	N/A		1K+	\$0.6500	reel of 1000	R0C ¢1¢T
LM4040CIM3-2.5	SOT-23	3	Full production	N/A	N/A		1K+	\$0.6500	reel of 1000	R2C ¢1¢T
LM4040CIM3-4.1	SOT-23	3	Full production	N/A	N/A		1K+	\$0.6500	reel of 1000	R4C ¢1¢T
LM4040CIM3-5.0	SOT-23	3	Full production	N/A	N/A		1K+	\$0.6500	reel of 1000	R5C ¢1¢T
LM4040CIM3-8.2	SOT-23	3	Full production	N/A	N/A		1K+	\$0.6500	reel of 1000	R8C ¢1¢T
LM4040DIM3-10.0	SOT-23	3	Full production	N/A	N/A		1K+	\$0.4500	reel of 1000	R0D ¢1¢T
LM4040DIM3-2.5	SOT-23	3	Full production	N/A	N/A		1K+	\$0.4500	reel of 1000	R2D ¢1¢T
LM4040DIM3-4.1	SOT-23	3	Full production	N/A	N/A		1K+	\$0.4500	reel of 1000	R4D ¢1¢T
LM4040DIM3-5.0	SOT-23	3	Full production	N/A	N/A		1K+	\$0.4500	reel of 1000	R5D ¢1¢T
LM4040DIM3-8.2	SOT-23	3	Full production	N/A	N/A		1K+	\$0.4300	reel of 1000	R8D ¢1¢T

LM4040EIM3-2.5	SOT-23	3	Full production	N/A	N/A		1K+	\$0.3400	reel of 1000	R2E ¢1¢T
LM4040CEM3-2.5	SOT-23	3	Full production	N/A	N/A	Samples	1K+	\$0.6900	reel of 1000	R2C ¢1¢T
LM4040CEM3-5.0	SOT-23	3	Full production	N/A	N/A		1K+	\$0.6900	reel of 1000	R5C ¢1¢T
LM4040DEM3-2.5	SOT-23	3	Full production	N/A	N/A	Samples 	1K+	\$0.5300	reel of 1000	R2D ¢1¢T
LM4040DEM3-5.0	SOT-23	3	Full production	N/A	N/A	Samples	1K+	\$0.5300	reel of 1000	R5D ¢1¢T
LM4040DIM3-6.0	SOT-23	3	Full production	N/A	N/A		1K+	\$0.4500	reel of 1000	R6D ¢1¢T
LM4040EEM3-2.5	SOT-23	3	Full production	N/A	N/A	Samples	1K+	\$0.4100	reel of 1000	R2E ¢1¢T
LM4040AIM3X-10	SOT-23	3	Full production	N/A	N/A		1K+	\$1.3000	reel of 3000	R0A ¢1¢T
LM4040AIM3X-2.5	SOT-23	3	Full production	N/A	N/A		1K+	\$1.3000	reel of 3000	R2A ¢1¢T
LM4040AIM3X-4.1	SOT-23	3	Full production	N/A	N/A		1K+	\$1.3000	reel of 3000	R4A ¢1¢T
LM4040AIM3X-5.0	SOT-23	3	Full production	N/A	N/A		1K+	\$1.3000	reel of 3000	R5A ¢1¢T
LM4040AIM3X-8.2	SOT-23	3	Full production	N/A	N/A		1K+	\$1.3000	reel of 3000	R8A ¢1¢T

LM4040BIM3X-10	SOT-23	3	Full production	N/A	N/A		1K+	\$0.8800	reel of 3000	R0B ø1¢T
LM4040BIM3X-2.5	SOT-23	3	Full production	N/A	N/A		1K+	\$0.8800	reel of 3000	R2B ø1¢T
LM4040BIM3X-4.1	SOT-23	3	Full production	N/A	N/A		1K+	\$0.8800	reel of 3000	R4B ø1¢T
LM4040BIM3X-5.0	SOT-23	3	Full production	N/A	N/A		1K+	\$0.8800	reel of 3000	R5B ø1¢T
LM4040BIM3X-8.2	SOT-23	3	Full production	N/A	N/A		1K+	\$0.8800	reel of 3000	R8B ø1¢T
LM4040CIM3X-10	SOT-23	3	Full production	N/A	N/A		1K+	\$0.6500	reel of 3000	R0C ø1¢T
LM4040CIM3X-2.5	SOT-23	3	Full production	N/A	N/A		1K+	\$0.6500	reel of 3000	R2C ø1¢T
LM4040CIM3X-4.1	SOT-23	3	Full production	N/A	N/A		1K+	\$0.6500	reel of 3000	R4C ø1¢T
LM4040CIM3X-5.0	SOT-23	3	Full production	N/A	N/A		1K+	\$0.6500	reel of 3000	R5C ø1¢T
LM4040CIM3X-8.2	SOT-23	3	Full production	N/A	N/A		1K+	\$0.6500	reel of 3000	R8C ø1¢T
LM4040DIM3X-10	SOT-23	3	Full production	N/A	N/A		1K+	\$0.4500	reel of 3000	R0D ø1¢T
LM4040DIM3X-2.5	SOT-23	3	Full production	N/A	N/A		1K+	\$0.4500	reel of 3000	R2D ø1¢T

LM4040DIM3X-4.1	SOT-23	3	Full production	N/A	N/A		1K+	\$0.4500	reel of 3000	R4D ø1¢T
LM4040DIM3X-5.0	SOT-23	3	Full production	N/A	N/A		1K+	\$0.4500	reel of 3000	R5D ø1¢T
LM4040DIM3X-6.0	SOT-23	3	Full production	N/A	N/A		1K+	\$0.4500	reel of 3000	R6D ø1¢T
LM4040DIM3X-8.2	SOT-23	3	Full production	N/A	N/A	.	1K+	\$0.4500	reel of 3000	R8D ø1¢T
LM4040EIM3X-2.5	SOT-23	3	Full production	N/A	N/A		1K+	\$0.3400	reel of 3000	R2E ø1¢T
LM4040DEM3X-2.5	SOT-23	3	Full production	N/A	N/A	.	1K+	\$0.5300	reel of 3000	R2D ø1¢T
LM4040DEM3X-5.0	SOT-23	3	Full production	N/A	N/A	.	1K+	\$0.5300	reel of 3000	R5D ø1¢T
LM4040EEM3X-2.5	SOT-23	3	Full production	N/A	N/A	.	1K+	\$0.4100	reel of 3000	R2E ø1¢T
LM4040AIZ-10.0	TO 92	3	Full production	N/A	N/A		1K+	\$1.3000	box of 1800	[logo]ø2¢T 4040A IZ10
LM4040AIZ-2.5	TO 92	3	Full production	N/A	N/A		1K+	\$1.3000	box of 1800	[logo]ø2¢T 4040A IZ2.5
LM4040AIZ-4.1	TO 92	3	Full production	N/A	N/A		1K+	\$1.3000	box of 1800	[logo]ø2¢T 4040A IZ4.1
LM4040AIZ-5.0	TO 92	3	Full production	N/A	N/A		1K+	\$1.3000	box of 1800	[logo]ø2¢T 4040A IZ5.0

LM4040AIZ-8.2	TO 92	3	Full production	N/A	N/A		1K+	\$1.3000	box of 1800	[logo]ç2çT 4040A IZ8.2
LM4040BIZ-10.0	TO 92	3	Full production	N/A	N/A		1K+	\$0.8800	box of 1800	[logo]ç2çT 4040B IZ10
LM4040BIZ-2.5	TO 92	3	Full production	N/A	N/A		1K+	\$0.8800	box of 1800	[logo]ç2çT 4040B IZ2.5
LM4040BIZ-4.1	TO 92	3	Full production	N/A	N/A		1K+	\$0.8800	box of 1800	[logo]ç2çT 4040B IZ4.1
LM4040BIZ-5.0	TO 92	3	Full production	N/A	N/A		1K+	\$0.8800	box of 1800	[logo]ç2çT 4040B IZ5.0
LM4040BIZ-8.2	TO 92	3	Full production	N/A	N/A		1K+	\$0.8800	box of 1800	[logo]ç2çT 4040B IZ8.2
LM4040CIZ-10.0	TO 92	3	Full production	N/A	N/A		1K+	\$0.6500	box of 1800	[logo]ç2çT 4040C IZ10
LM4040CIZ-2.5	TO 92	3	Full production	N/A	N/A		1K+	\$0.6500	box of 1800	[logo]ç2çT 4040C IZ2.5
LM4040CIZ-4.1	TO 92	3	Full production	N/A	N/A		1K+	\$0.6500	box of 1800	[logo]ç2çT 4040C IZ4.1
LM4040CIZ-5.0	TO 92	3	Full production	N/A	N/A		1K+	\$0.6500	box of 1800	[logo]ç2çT 4040C IZ5.0
LM4040CIZ-8.2	TO 92	3	Full production	N/A	N/A		1K+	\$0.6500	box of 1800	[logo]ç2çT 4040C IZ8.2
LM4040DIZ-10.0	TO 92	3	Full production	N/A	N/A		1K+	\$0.4500	box of 1800	[logo]ç2çT 4040D IZ10

LM4040DIZ-2.5	TO 92	3	Full production	N/A	N/A		1K+	\$0.4500	box of 1800	[logo]¢2¢T 4040D IZ2.5
LM4040DIZ-4.1	TO 92	3	Full production	N/A	N/A		1K+	\$0.4500	box of 1800	[logo]¢2¢T 4040D IZ4.1
LM4040DIZ-5.0	TO 92	3	Full production	N/A	N/A		1K+	\$0.4500	box of 1800	[logo]¢2¢T 4040D IZ5.0
LM4040DIZ-8.2	TO 92	3	Full production	N/A	N/A		1K+	\$0.4500	box of 1800	[logo]¢2¢T 4040D IZ8.2
LM4040EIZ-2.5	TO 92	3	Full production	N/A	N/A		1K+	\$0.3400	box of 1800	[logo]¢2¢T 4040E IZ2.5
LM4040D-2.5 MDC	die		Lifetime buy	N/A	N/A	.			N/A	-
LM4040D-1.2 MDC	die		Preliminary	N/A	N/A	.			N/A	-
LM4040C-2.5 MDA	die		Full production	N/A	N/A	.			N/A	-
LM4040D-2.5 MWC	wafer		Full production	N/A	N/A	.			N/A	-
LM4040D-5 MWC	wafer		Full production	N/A	N/A	.			N/A	-
LM4040CI4.1 MDA	die		Full production	N/A	N/A	.			N/A	-

[Information as of 29-Aug-2000]

Quick Search

[Parametric Search](#)

[System Diagrams](#)

[Product Tree](#)

[Home](#)

[About Languages](#) . [About the Site](#) . [About "Cookies"](#)

National is [QS 9000 Certified](#) . [Privacy/Security](#)

[Copyright © National Semiconductor Corporation](#)

[Preferences](#) . [Feedback](#)