



2732A

32K (4K x 8) UV ERASABLE PROMS

- 200 ns (2732A-2) Maximum Access Time ... HMOS*-E Technology
- Compatible with High-Speed Microcontrollers and Microprocessors ... Zero WAIT State
- Two Line Control
- 10% V_{CC} Tolerance Available
- Low Current Requirement
 - 100 mA Active
 - 35 mA Standby
- intelligent Identifier™ Mode
 - Automatic Programming Operation
- Industry Standard Pinout ... JEDEC Approved 24 Pin Ceramic Package

(See Packaging Spec. Order # 231369)

The Intel 2732A is a 5V-only, 32,768-bit ultraviolet erasable (cerdip) Electrically Programmable Read-Only Memory (EPROM). The standard 2732A access time is 250 ns with speed selection (2732A-2) available at 200 ns. The access time is compatible with high performance microprocessors such as the 8 MHz iAPX 186. In these systems, the 2732A allows the microprocessor to operate without the addition of WAIT states.

An important 2732A feature is Output Enable (\overline{OE}) which is separate from the Chip Enable (\overline{CE}) control. The \overline{OE} control eliminates bus contention in microprocessor systems. The \overline{CE} is used by the 2732A to place it in a standby mode ($\overline{CE} = V_{IH}$) which reduces power consumption without increasing access time. The standby mode reduces the current requirement by 65%; the maximum active current is reduced from 100 mA to a standby current of 35 mA.

*HMOS is a patented process of Intel Corporation.

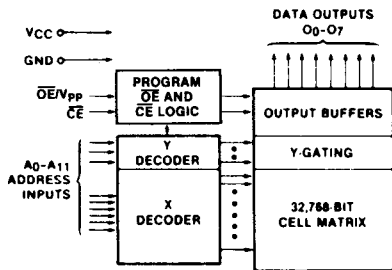

290081-1

Figure 1. Block Diagram

Pin Names

A ₀ -A ₁₁	Addresses
\overline{CE}	Chip Enable
\overline{OE}/V_{PP}	Output Enable/ V_{PP}
O ₀ -O ₇	Outputs



27512 27C512	27256 27C256	27128A 27C128	2764A 27C64 87C64	2716
A ₁₅	V _{PP}	V _{PP}	V _{PP}	A ₇
A ₁₂	A ₁₂	A ₁₂	A ₁₂	A ₅
A ₇	A ₇	A ₇	A ₇	A ₄
A ₆	A ₆	A ₆	A ₆	A ₄
A ₅	A ₅	A ₅	A ₅	A ₅
A ₄	A ₄	A ₄	A ₄	A ₄
A ₃	A ₃	A ₃	A ₃	A ₃
A ₂	A ₂	A ₂	A ₂	A ₂
A ₁	A ₁	A ₁	A ₁	A ₁
A ₀	A ₀	A ₀	A ₀	A ₀
O ₀	O ₀	O ₀	O ₀	O ₀
O ₁	O ₁	O ₁	O ₁	O ₁
O ₂	O ₂	O ₂	O ₂	O ₂
GND	GND	GND	GND	GND

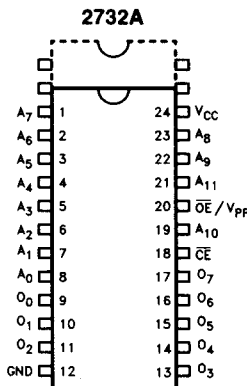

290081-2

2716	2764 2764A 87C64	27128A 27C128	27256 27C256	27512 27C512
V _{CC}	V _{CC}	V _{CC}	V _{CC}	V _{CC}
A ₈	N.C.	A ₁₃	A ₁₄	A ₁₄
A ₉	A ₈	A ₈	A ₈	A ₈
V _{PP}	A ₉	A ₉	A ₉	A ₉
OE	A ₁₁	A ₁₁	A ₁₁	A ₁₁
A ₁₀	A ₁₀	A ₁₀	A ₁₀	A ₁₀
CE	OE	OE	OE	OE/V _{PP}
O ₇	CE	CE	CE	CE
O ₆	O ₇	O ₇	O ₇	O ₇
O ₅	O ₆	O ₆	O ₆	O ₆
O ₄	O ₅	O ₅	O ₅	O ₅
O ₃	O ₄	O ₄	O ₄	O ₄
	O ₃	O ₃	O ₃	O ₃

NOTE:

Intel "Universal Site" compatible EPROM configurations are shown in the blocks adjacent to the 2732A pins.

Figure 2. Cerdip Pin Configuration

EXTENDED TEMPERATURE (EXPRESS) EPROMS

The Intel EXPRESS EPROM family is a series of electrically programmable read only memories which have received additional processing to enhance product characteristics. EXPRESS processing is available for several densities of EPROM, allowing the choice of appropriate memory size to match system applications. EXPRESS EPROM products are available with 168 ± 8 hour, 125°C dynamic burn-in using Intel's standard bias configuration. This process exceeds or meets most industry specifications of burn-in. The standard EXPRESS EPROM operating temperature range is 0°C to 70°C . Extended operating temperature range (-40°C to $+85^\circ\text{C}$) EXPRESS products are available. Like all Intel EPROMs, the EXPRESS EPROM family is inspected to 0.1% electrical AQL. This may allow the user to reduce or eliminate incoming inspection testing.

READ OPERATION

D.C. CHARACTERISTICS

Electrical Parameters of EXPRESS EPROM products are identical to standard EPROM parameters except for:

Symbol	Parameter	TD2732A LD2732A		Test Conditions
		Min	Max	
I_{SB}	V_{CC} Standby Current (mA)		45	$\overline{CE} = V_{IH}$, $\overline{OE} = V_{IL}$
$I_{CC1}^{(1)}$	V_{CC} Active Current (mA)		150	$\overline{OE} = \overline{CE} = V_{IL}$
	V_{CC} Active Current at High Temperature (mA)		125	$\overline{OE} = \overline{CE} = V_{IL}$, $V_{PP} = V_{CC}$, $T_{Ambient} = 85^\circ\text{C}$

NOTE:

1. Maximum current value is with outputs O_0 to O_7 unloaded.

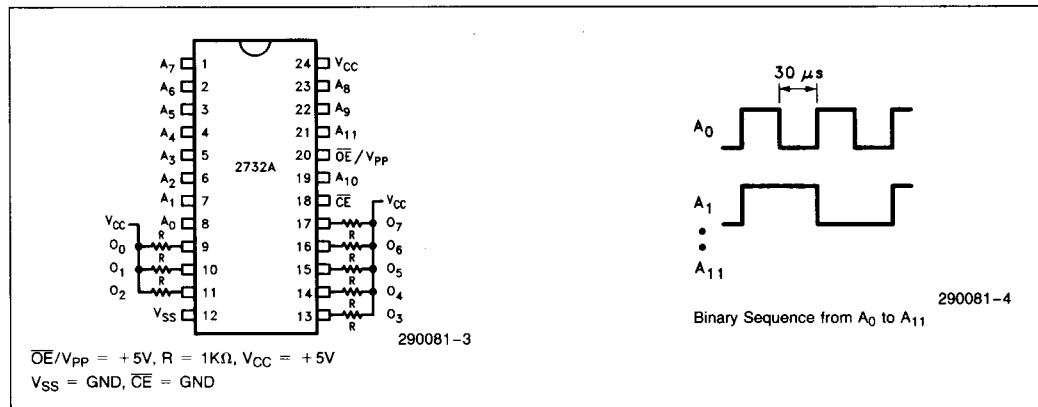

Burn-In Bias and Timing Diagrams

EXPRESS EPROM PRODUCT FAMILY

PRODUCT DEFINITIONS

Type	Operating Temperature	Burn-In 125°C (hr)
Q	0°C to $+70^\circ\text{C}$	168 ± 8
T	-40°C to $+85^\circ\text{C}$	None
L	-40°C to $+85^\circ\text{C}$	168 ± 8

EXPRESS OPTIONS

2732A Versions

Packaging Options	
Speed Versions	Cerdip
-2	Q
-25	Q, T, L

ABSOLUTE MAXIMUM RATINGS*

Operating Temp. During Read 0°C to +70°C
Temperature Under Bias -10°C to +80°C
Storage Temperature -65°C to +125°C
All Input or Output Voltages with	
Respect to Ground -0.3V to +6V
Voltage on A9 with Respect	
to Ground -0.3V to +13.5V
V _{PP} Supply Voltage with Respect to Ground	
During Programming -0.3V to +22V
V _{CC} Supply Voltage with	
Respect to Ground -0.3V to +7.0V

NOTICE: This is a production data sheet. The specifications are subject to change without notice.

**WARNING: Stressing the device beyond the "Absolute Maximum Ratings" may cause permanent damage. These are stress ratings only. Operation beyond the "Operating Conditions" is not recommended and extended exposure beyond the "Operating Conditions" may affect device reliability.*

READ OPERATION

D.C. CHARACTERISTICS 0°C ≤ T_A ≤ +70°C

Symbol	Parameter	Limits			Units	Conditions
		Min	Typ ⁽³⁾	Max		
I _{LI}	Input Load Current			10	μA	V _{IN} = 5.5V
I _{LO}	Output Leakage Current			10	μA	V _{OUT} = 5.5V
I _{SB} ⁽²⁾	V _{CC} Current (Standby)			35	mA	$\overline{CE} = V_{IH}, \overline{OE} = V_{IL}$
I _{CC1} ⁽²⁾	V _{CC} Current (Active)			100	mA	$\overline{OE} = \overline{CE} = V_{IL}$
V _{IL}	Input Low Voltage	-0.1		0.8	V	
V _{IH}	Input High Voltage	2.0		V _{CC} + 1	V	
V _{OL}	Output Low Voltage			0.45	V	I _{OL} = 2.1 mA
V _{OH}	Output High Voltage	2.4			V	I _{OH} = -400 μA

5

A.C. CHARACTERISTICS 0°C ≤ T_A ≤ 70°C

Versions	V _{CC} ± 5%	2732A-2		2732A		Units	Test Conditions
	V _{CC} ± 10%	2732A-20		2732A-25			
Symbol	Parameter	Min	Max	Min	Max		
t _{ACC}	Address to Output Delay		200		250	ns	$\overline{CE} = \overline{OE} = V_{IL}$
t _{CE}	\overline{CE} to Output Delay		200		250	ns	$\overline{OE} = V_{IL}$
t _{OE}	\overline{OE}/V_{PP} to Output Delay		70		100	ns	$\overline{CE} = V_{IL}$
t _{DF} ⁽⁴⁾	\overline{OE}/V_{PP} High to Output Float	0	60	0	60	ns	$\overline{CE} = V_{IL}$
t _{OH} ⁽⁴⁾	Output Hold from Addresses, \overline{CE} or \overline{OE}/V_{PP} , Whichever Occurred First	0		0		ns	$\overline{CE} = \overline{OE} = V_{IL}$

NOTES:

- V_{CC} must be applied simultaneously or before \overline{OE}/V_{PP} and removed simultaneously or after \overline{OE}/V_{PP} .
- The maximum current value is with outputs O₀ to O₇ unloaded.
- Typical values are for T_A = 25°C and nominal supply voltages.
- This parameter is only sampled and is not 100% tested. Output Float is defined as the point where data is no longer driven—see timing diagram.

CAPACITANCE (2) $T_A = 25^\circ\text{C}$, $f = 1\text{ MHz}$

Symbol	Parameter	Typ	Max	Unit	Conditions
C_{IN1}	Input Capacitance Except \overline{OE}/V_{PP}	4	6	pF	$V_{IN} = 0V$
C_{IN2}	\overline{OE}/V_{PP} Input Capacitance		20	pF	$V_{IN} = 0V$
C_{OUT}	Output Capacitance	8	12	pF	$V_{OUT} = 0V$

A.C. TESTING INPUT/OUTPUT WAVEFORM

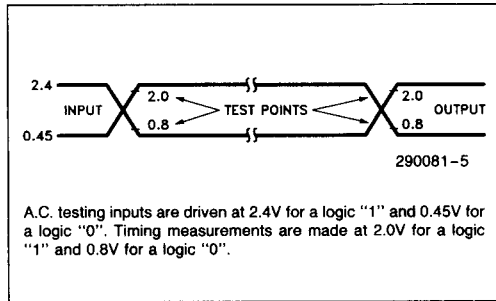

A.C. TESTING LOAD CIRCUIT

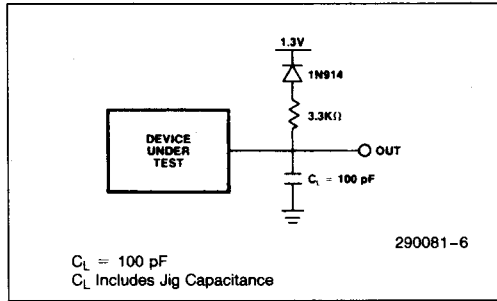

A.C. WAVEFORMS

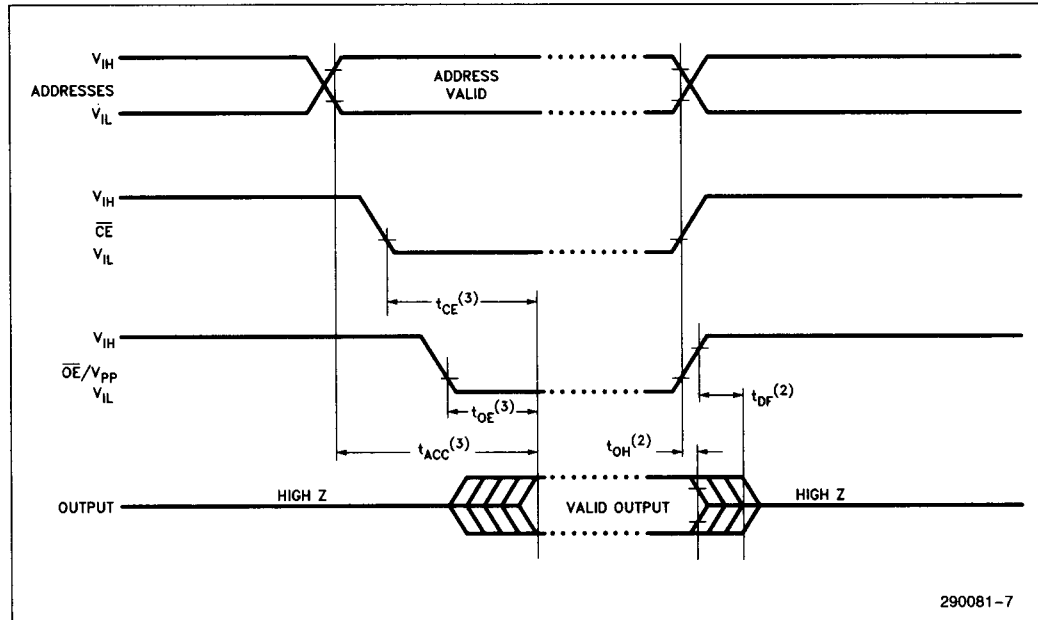

NOTES:

1. Typical values are for $T_A = 25^\circ\text{C}$ and nominal supply voltages.
2. This parameter is only sampled and is not 100% tested. Output float is defined as the point where data is no longer driven—see timing diagram.
3. \overline{OE}/V_{PP} may be delayed up to $t_{ACC} - t_{OE}$ after the falling edge of \overline{CE} without impacting t_{CE} .

DEVICE OPERATION

The modes of operation of the 2732A are listed in Table 1. A single 5V power supply is required in the read mode. All inputs are TTL levels except for \overline{OE}/V_{PP} during programming and 12V on A_9 for the intelligent Identifier™ mode. In the program mode the \overline{OE}/V_{PP} input is pulsed from a TTL level to 21V.

Table 1. Mode Selection

Mode	Pins					
	\overline{CE}	\overline{OE}/V_{PP}	A_9	A_0	V_{CC}	Outputs
Read/Program Verify	V_{IL}	V_{IL}	X	X	V_{CC}	DOUT
Output Disable	V_{IL}	V_{IH}	X	X	V_{CC}	High Z
Standby	V_{IH}	X	X	X	V_{CC}	High Z
Program	V_{IL}	V_{PP}	X	X	V_{CC}	D_{IN}
Program Inhibit	V_{IH}	V_{PP}	X	X	V_{CC}	High Z
Intelligent Identifier ⁽³⁾						
—Manufacturer	V_{IL}	V_{IL}	V_H	V_{IL}	V_{CC}	89H
—Device	V_{IL}	V_{IL}	V_H	V_{IH}	V_{CC}	01H

NOTES:

1. X can be V_{IH} or V_{IL} .
2. $V_H = 12V \pm 0.5V$.
3. $A_1-A_8, A_{10}, A_{11} = V_{IL}$.

Read Mode

The 2732A has two control functions, both of which must be logically active in order to obtain data at the outputs. Chip Enable (\overline{CE}) is the power control and should be used for device selection. Output Enable (\overline{OE}/V_{PP}) is the output control and should be used to gate data from the output pins, independent of device selection. Assuming that addresses are stable, address access time (t_{ACC}) is equal to the delay from \overline{CE} to output (t_{CE}). Data is available at the outputs after the falling edge of \overline{OE}/V_{PP} , assuming that \overline{CE} has been low and addresses have been stable for at least $t_{ACC}-t_{OE}$.

Standby Mode

EPROMs can be placed in a standby mode which reduces the maximum active current of the device

by applying a TTL-high signal to the \overline{CE} input. When in standby mode, the outputs are in a high impedance state, independent of the \overline{OE}/V_{PP} input.

Two Line Output Control

Because EPROMs are usually used in larger memory arrays, Intel has provided two control lines which accommodate this multiple memory connection. The two control lines allow for:

- a) The lowest possible memory power dissipation, and
- b) complete assurance that output bus contention will not occur.

To use these two control lines most efficiently, \overline{CE} should be decoded and used as the primary device selecting function, while \overline{OE}/V_{PP} should be made a common connection to all devices in the array and connected to the \overline{READ} line from the system control bus. This assures that all deselected memory devices are in their low power standby mode and that the output pins are active only when data is desired from a particular memory device.

SYSTEM CONSIDERATION

The power switching characteristics of EPROMs require careful decoupling of the devices. The supply current, I_{CC} , has three segments that are of interest to the system designer—the standby current level, the active current level, and the transient current peaks that are produced by the falling and rising edges of Chip Enable. The magnitude of these transient current peaks is dependent on the output capacitive and inductive loading of the device. The associated transient voltage peaks can be suppressed by complying with Intel's two-line control and by use of properly selected decoupling capacitors. It is recommended that a 0.1 μF ceramic capacitor be used on every device between V_{CC} and GND. This should be a high frequency capacitor of low inherent inductance and should be placed as close to the device as possible. In addition, a 4.7 μF bulk electrolytic capacitor should be used between V_{CC} and GND for

every eight devices. The bulk capacitor should be located near where the power supply is connected to the array. The purpose of the bulk capacitor is to overcome the voltage droop caused by the inductive effects of PC board traces.

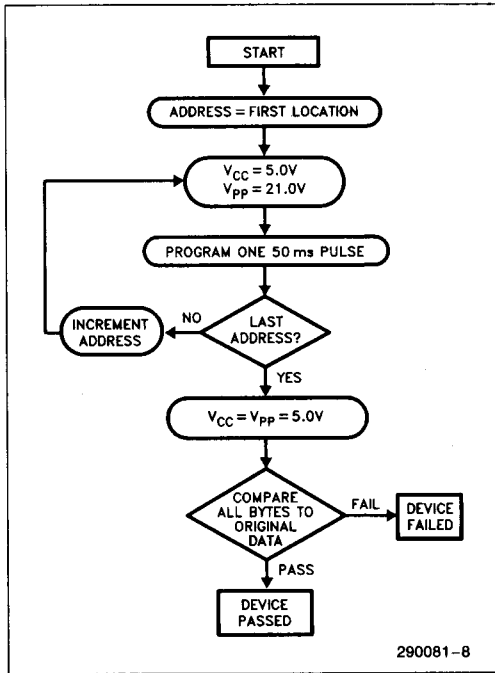

Figure 3. Standard Programming Flowchart

PROGRAMMING MODES

CAUTION: Exceeding 22V on \overline{OE}/V_{PP} will permanently damage the device.

Initially, and after each erasure (cerdip EPROMs), all bits of the EPROM are in the "1" state. Data is introduced by selectively programming "0s" into the bit locations. Although only "0s" will be programmed, both "1s" and "0s" can be present in the data word. The only way to change a "0" to a "1" in cerdip EPROMs is by ultraviolet light erasure.

The device is in the programming mode when the \overline{OE}/V_{PP} input is at 21V. It is required that a 0.1 μ F capacitor be placed across \overline{OE}/V_{PP} and ground to suppress spurious voltage transients which may damage the device. The data to be programmed is applied 8 bits in parallel to the data output pins. The levels required for the address and data inputs are TTL.

When the address and data are stable, a 20 ms (50 ms typical) active low, TTL program pulse is ap-

plied to the \overline{CE} input. A program pulse must be applied at each address location to be programmed (see Figure 3). Any location can be programmed at any time—either individually, sequentially, or at random. The program pulse has a maximum width of 55 ms. The EPROM must not be programmed with a DC signal applied to the \overline{CE} input.

Programming of multiple 2732As in parallel with the same data can be easily accomplished due to the simplicity of the programming requirements. Like inputs of the paralleled 2732As may be connected together when they are programmed with the same data. A low level TTL pulse applied to the \overline{CE} input programs the paralleled 2732As.

Program Inhibit

Programming of multiple EPROMs in parallel with different data is easily accomplished by using the Program Inhibit mode. A high level \overline{CE} input inhibits the other EPROMs from being programmed. Except for \overline{CE} , all like inputs (including \overline{OE}/V_{PP}) of the parallel EPROMs may be common. A TTL low level pulse applied to the \overline{CE} input with \overline{OE}/V_{PP} at 21V will program that selected device.

Program Verify

A verify (Read) should be performed on the programmed bits to determine that they have been correctly programmed. The verify is performed with \overline{OE}/V_{PP} and \overline{CE} at V_{IL} . Data should be verified t_{DV} after the falling edge of \overline{CE} .

intelligent Identifier™ Mode

The intelligent Identifier Mode allows the reading out of a binary code from an EPROM that will identify its manufacturer and type. This mode is intended for use by programming equipment for the purpose of automatically matching the device to be programmed with its corresponding programming algorithm. This mode is functional in the 25°C \pm 5°C ambient temperature range that is required when programming the device.

To activate this mode, the programming equipment must force 11.5V to 12.5V on address line A9 of the EPROM. Two identifier bytes may then be sequenced from the device outputs by toggling address line A0 from V_{IL} to V_{IH} . All other address lines must be held at V_{IL} during the intelligent Identifier Mode.

Byte 0 ($A0 = V_{IL}$) represents the manufacturer code and byte 1 ($A0 = V_{IH}$) the device identifier code. These two identifier bytes are given in Table 1.

ERASURE CHARACTERISTICS

The erasure characteristics are such that erasure begins to occur upon exposure to light with wavelengths shorter than approximately 4000 Angstroms (Å). It should be noted that sunlight and certain types of fluorescent lamps have wavelengths in the 3000–4000Å range. Data shows that constant exposure to room level fluorescent lighting could erase the EPROM in approximately 3 years, while it would take approximately 1 week to cause erasure when exposed to direct sunlight. If the device is to be exposed to these types of lighting conditions for extended periods of time, opaque labels should be placed over the window to prevent unintentional erasure.

The recommended erasure procedure is exposure to shortwave ultraviolet light which has a wavelength of 2537 Angstroms (Å). The integrated dose (i.e., UV intensity × exposure time) for erasure should be a minimum of 15 Wsec/cm². The erasure time with this dosage is approximately 15 to 20 minutes using an ultraviolet lamp with a 12000 μW/cm² power rating. The EPROM should be placed within 1 inch of the lamp tubes during erasure. The maximum integrated dose an EPROM can be exposed to without damage is 7258 Wsec/cm² (1 week @ 12000 μW/cm²). Exposure of the device to high intensity UV light for longer periods may cause permanent damage.

PROGRAMMING

D.C. PROGRAMMING CHARACTERISTICS

$T_A = 25^\circ\text{C} \pm 5^\circ\text{C}$, $V_{CC} = 5\text{V} \pm 5\%$, $V_{PP} = 21\text{V} \pm 0.5\text{V}$

Symbol	Parameter	Limits			Units	Test Conditions (Note 1)
		Min	Typ ⁽³⁾	Max		
I_{LI}	Input Current (All Inputs)			10	μA	$V_{IN} = V_{IL}$ or V_{IH}
V_{IL}	Input Low Level (All Inputs)	-0.1		0.8	V	
V_{IH}	Input High Level (All Inputs Except \overline{OE}/V_{PP})	2.0		$V_{CC} + 1$	V	
V_{OL}	Output Low Voltage During Verify			0.45	V	$I_{OL} = 2.1\text{ mA}$
V_{OH}	Output High Voltage During Verify	2.4			V	$I_{OH} = -400\ \mu\text{A}$
$I_{CC2}^{(4)}$	V_{CC} Supply Current (Program and Verify)		85	100	mA	
$I_{PP2}^{(4)}$	V_{PP} Supply Current (Program)			30	mA	$\overline{OE} = V_{IL}$, $\overline{OE}/V_{PP} = V_{PP}$
V_{ID}	A_9 intelligent Identifier Voltage	11.5		12.5	V	

A.C. PROGRAMMING CHARACTERISTICS
 $T_A = 25^\circ\text{C} \pm 5^\circ\text{C}$, $V_{CC} = 5\text{V} \pm 5\%$, $V_{PP} = 21\text{V} \pm 0.5\text{V}$

Symbol	Parameter	Limits			Units	Test Conditions* (Note 1)
		Min	Typ ⁽³⁾	Max		
t _{AS}	Address Setup Time	2			μs	
t _{OES}	$\overline{\text{OE}}/V_{PP}$ Setup Time	2			μs	
t _{DS}	Data Setup Time	2			μs	
t _{AH}	Address Hold Time	0			μs	
t _{DH}	Data Hold Time	2			μs	
t _{DFP}	$\overline{\text{OE}}/V_{PP}$ High to Output Not Driven	0		130	ns	(Note 2)
t _{PW}	$\overline{\text{CE}}$ Pulse Width During Programming	20	50	55	ms	
t _{OEH}	$\overline{\text{OE}}/V_{PP}$ Hold Time	2			μs	
t _{DV}	Data Valid from $\overline{\text{CE}}$			1	μs	$\overline{\text{CE}} = V_{IL}$, $\overline{\text{OE}}/V_{PP} = V_{IL}$
t _{VR}	V _{PP} Recovery Time	2			μs	
t _{PRT}	$\overline{\text{OE}}/V_{PP}$ Pulse Rise Time During Programming	50			ns	

NOTES:

1. V_{CC} must be applied simultaneously or before $\overline{\text{OE}}/V_{PP}$ and removed simultaneously or after $\overline{\text{OE}}/V_{PP}$.
2. This parameter is only sampled and is not 100% tested. Output Float is defined as the point where data is no longer driven—see timing diagram.
3. Typical values are for T_A = 25°C and nominal supply voltages.
4. The maximum current value is with outputs O₀ to O₇ unloaded.

***A.C. TEST CONDITIONS**

Input Rise and Fall Time (10% to 90%) ≤ 20 ns
 Input Pulse Levels 0.45V to 2.4V
 Input Timing Reference Level 0.8V and 2.0V
 Output Timing Reference Level 0.8V and 2.0V

PROGRAMMING WAVEFORMS

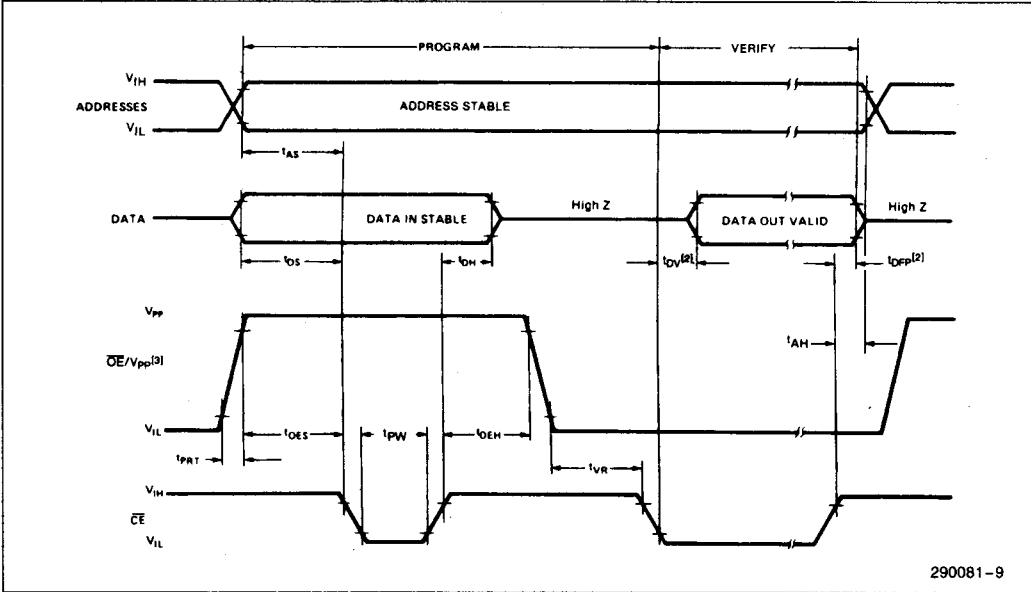

290081-9

NOTES:

1. The input timing reference level is 0.8V for a V_{IL} and 2V for a V_{IH} .
2. t_{DV} and t_{DFP} are characteristics of the device but must be accommodated by the programmer.
3. When programming the 2732A, a 0.1 μ F capacitor is required across \overline{OE}/V_{PP} and ground to suppress spurious voltage transients which can damage the device.

5

REVISION HISTORY

Number	Description
04	Revised Pin Configuration. Revised Express Options. Deleted -3, -30, -4, and -45 speed bins.