

## PHASE CONTROL SCR's 63 TO 190 AMPERES

GE TYPE	C45, 46	C147	C50, 52	C150, 152	C60, 62	C350	
JEDEC			2N1909-16 2N1792-98		2N2023-30		
<b>ELECTRICAL SPECIFICATIONS</b>							
<b>VOLTAGE RANGE</b>	25-1200	25-1200	25-1200	500-1300	25-500	500-1300	
<b>FORWARD CONDUCTION</b>							
$I_T$ (RMS) Max. RMS on-state current (A)	90	63	110	110	110	190	
$I_T$ (AV) Max. average on-state current @ 180° conduction (A) @ $T_C$	35 @ 87°C	40 @ 102°C	70 @ 82°C	70 @ 80°C	70 @ 88°C	110 @ 90°C	
$I_T$ (AV) Max. average on-state current for $3\phi$ conduction (A) @ $T_C$	32 @ 90°C	36 @ 101°C	62 @ 65°C	59 @ 87°C	59 @ 90°C	95 @ 85°C	
$I_{TSM}$ Max. peak one cycle, non-repetitive surge current (A)	800	1000	1000	1600	1000	1600	
$I^2t$ Max. $I^2t$ for fusing for 5 to 8.3 msec ( $A^2$ sec)	2600	4150	4150	7000	4000	10,600	
$V_{TM}$ Peak on-state voltage @ 125°C, 180° conduction rated $I_T$ (AV) (V)	2.1	1.4	1.8	2.0	1.8	2.5	
$R\theta_{JC}$ Max. internal thermal resistance, dc, junction-to-case (°C/W)	.4	.35	.4	.3	.4	.135	
$t_q$ Typical turn-off time ( $\mu$ sec)	80	125	80	100	80	125	
$t_d$ $t_r$ Typical turn-on time ( $\mu$ sec)	5	5	5	8	5	8	
$di/dt$ Rate-of-rise turned-on current (A/ $\mu$ sec)	100	100	100	200	30	200	
$T_J$ Junction operating temperature range (°C)	-40 to 125°C	-40 to 125°C	-40 to 125°C	-40 to 125°C	-65 to 150°C	-40 to 125°C	
<b>BLOCKING</b>							
$dv/dt$ Min. critical rate-of-rise of off-stage voltage, exponential @ max. rated $T_J$ (V/ $\mu$ sec)	100	200	200	200	30 TYP.	200	
<b>FIRING</b>							
$I_{GT}$ Max. required gate current to trigger (mA) @ -40°C	130	300	125	200	125	200	
	@ 125°C	40	125	40	125	40	
$V_{GT}$ Max. required gate voltage to trigger (V) @ -40°C	3	3.0	3	3	3	3	
$V_{GT}$ Min. required gate voltage to trigger (V) @ -40°C	.25	.25	.25	.15	.25	.15	
<b>VOLTAGE TYPES</b>							
Repetitive Peak Forward and Reverse Voltages							
25	C45U C46U	C147U	2N1909 C52U	CONSULT FACTORY	2N2023 C62U	-	
50	C45F C46F	C147F	2N1910 2N1792		2N2024 C62F	-	
100	C45A C46A	C147A	2N1911 2N1793		2N2025 C62A	-	
150	C45G C46G	C147G	2N1912 2N1794		2N2026 C62G	-	
200	C45B C46B	C147B	2N1913 2N1795		2N2027 C62B	-	
250	C45H C46H	C147H	2N1914 2N1796		2N2028 C62H	-	
300	C45C C46C	C147C	2N1915 2N1797		2N2029 C62C	-	
400	C45D C46D	C147D	2N1916 2N1798		2N2030 C62D	-	
500	C45E C46E	C147E	C50E C52E		C150E C152E	C60E C62E	C350E
600	C45M C46M	C147M	C50M C52M		C150M C152M		C350M
700	C45S C46S	C147S	C50S C52S		C150S C152S		C350S
800	C45N C46N	C147N	C50N C52N		C150N C152N		C350N
900	C45T C46T	C147T	C50T C52T		C150T C152T		C350T
1000	C45P C46P	C147P	C50P C52P	C150P C152P		C350P	
1100	C45PA C46PA	C147PA	C50PA C52PA	C150PA C152PA		C350PA	
1200	C45PB C46PB	C147PB	C50PB C52PB	C150PB C152PB		C350PB	
1300				C150PC C152PC		C350PC	
<b>PACKAGE TYPE</b>	½" STUD	½" STUD	½" STUD	½" STUD	½" STUD	½" PRESS PAK	
<b>PACKAGE OUTLINE NO.</b>	108, 109	108.1	109, 108	109, 108	109, 108	280	

# High Power Silicon Controlled Rectifier

**110 A RMS    25 to 1200 Volts**

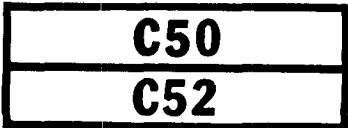

The General Electric C50 and C52 Silicon Controlled Rectifiers are all-diffused devices designed for phase control applications.

**FEATURES:**

- High dv/dt With Selection Available
- Excellent Surge and I<sup>2</sup>t Ratings Providing Easy Fusing
- Rugged Hermetic Package

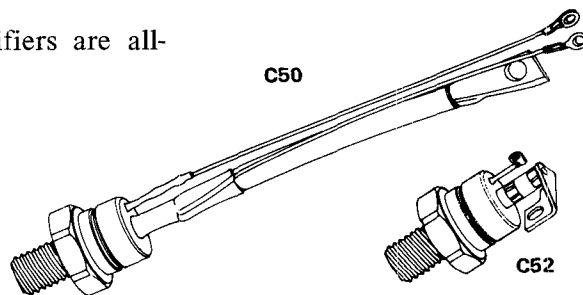

**MAXIMUM ALLOWABLE RATINGS**

TYPE	REPETITIVE PEAK OFF-STATE VOLTAGE $V_{DRM}^1$ $T_J = -40^\circ\text{C to } +125^\circ\text{C}$	REPETITIVE PEAK REVERSE VOLTAGE $V_{RRM}^1$ $T_J = -40^\circ\text{C to } +125^\circ\text{C}$	NON-REPETITIVE PEAK REVERSE VOLTAGE $V_{RSM}^1$ $T_J = +125^\circ\text{C}$
C50U (2N1909)    C52U	25 Volts	25 Volts	25 Volts
C50F (2N1910)    C52F (2N1792)	50	50	75
C50A (2N1911)    C52A (2N1793)	100	100	150
C50G (2N1912)    C52G (2N1794)	150	150	225
C50B (2N1913)    C52B (2N1795)	200	200	300
C50H (2N1914)    C52H (2N1796)	250	250	350
C50C (2N1915)    C52C (2N1797)	300	300	400
C50D (2N1916)    C52D (2N1798)	400	400	500
C50E	500	500	600
C50M	600	600	720
C50S	700	700	840
C50N	800	800	960
C50T	900	900	1040
C50P	1000	1000	1200
C50PA	1100	1100	1320
C50PB	1200	1200	1440

<sup>1</sup> Half sine wave waveform, 10 msec, maximum pulse width.

RMS On-State Current, $I_{T(RMS)}$ .....	110 Amperes (All Conduction Angles)
Average On-State Current, $I_{T(AV)}$ .....	Depends on Conduction Angles (See Charts 3 and 4)
Critical Rate-of-Rise of On-State Current (Non-Repetitive) di/dt:*	
Switching From 1200 Volts .....	100 Amperes Per Microsecond
Switching From 600 Volts .....	200 Amperes Per Microsecond
Peak One-Cycle Surge (Non-Repetitive) On-State Current, $I_{TSM}$ (60 Hz) .....	1000 Amperes
Peak One-Cycle Surge (Non-Repetitive) On-State Current, $I_{TSM}$ (50 Hz) .....	910 Amperes
I <sup>2</sup> t (for fusing), for times ≥ 8.3 milliseconds (See Figure 9) .....	4150 (RMS Ampere) <sup>2</sup> Seconds
I <sup>2</sup> t (for fusing), for times ≥ 1.5 milliseconds (See Figure 9) .....	2850 (RMS Ampere) <sup>2</sup> Seconds
Peak Gate Power Dissipation, $P_{GM}$ (See Figure 7) .....	100 Watts for 150 Microseconds
Average Gate Power Dissipation, $P_{G(AV)}$ .....	2 Watts
Storage Temperature, $T_{stg}$ .....	-40°C to +150°C
Operating Temperature, $T_J$ .....	-40°C to +125°C
Stud Torque .....	125 Lbs.-In. (Min.) – 150 Lbs.-In. (Max.) 14 N-m (Min.) – 17 N-m (Max.)

\*di/dt ratings established in accordance with EIA-NEMA Standard RS-397, Section 5.2.2.6 for conditions of  $V_{DRM}$  stated above; 20 volts, 20 ohms gate trigger source with 0.5 μsec short circuit trigger current rise time.

## CHARACTERISTICS

TEST	SYMBOL	MIN.	MAX.	UNITS	TEST CONDITIONS
Repetitive Peak Reverse and Off-State Current	$I_{DRM}$ and $I_{RRM}$	—	10	mA	$T_J = -40^\circ\text{C}$ to $+125^\circ\text{C}$ $V_{DRM} = V_{RRM}$
C50, C52U (2N1909)					25 Volts Peak
C50, C52F					50
C50, C52A (2N1910) (2N1792)					100
C50, C52G (2N1911) (2N1793)					150
C50, C52B (2N1912) (2N1794)					200
C50, C52H					250
C50, C52C (2N1913) (2N1795)					300
C50, C52D (2N1914) (2N1796)					400
C50, C52E (2N1915) (2N1797)					500
C50, C52M					600
C50, C52S (2N1916) (2N1798)					700
C50, C52N					800
C50, C52T					900
C50, C52P					1000
C50, C52PA					1100
C50, C52PB					1200
DC Gate Trigger Current	$I_{GT}$	—	75	mAdc	$T_C = +25^\circ\text{C}$ , $V_D = 6\text{ Vdc}$ , $R_L = 3\text{ Ohms}$ $t_p \geq 20\ \mu\text{sec}$
		—	130		$T_C = -40^\circ\text{C}$ , $V_D = 6\text{ Vdc}$ , $R_L = 3\text{ Ohms}$ $t_p \geq 20\ \mu\text{sec}$
		—	40		$T_C = +125^\circ\text{C}$ , $V_D = 6\text{ Vdc}$ , $R_L = 3\text{ Ohms}$ $t_p \geq 20\ \mu\text{sec}$
DC Gate Trigger Voltage	$V_{GT}$	—	3.0	Vdc	$T_C = -40^\circ\text{C}$ to $+125^\circ\text{C}$ , $V_D = 6\text{ Vdc}$ , $R_L = 50\text{ Ohms}$ , $t_p \geq 20\ \mu\text{sec}$
		.25	—		$T_C = +125^\circ\text{C}$ , $V_D = \text{Rated}$ , $R_L = 1000\text{ Ohms}$ , $t_p = 20\ \mu\text{sec}$
Peak On-State Voltage	$V_{TM}$	—	2.5	Volts	$T_C = +25^\circ\text{C}$ , $I_{TM} = 500\text{ Amps. Peak}$ . Duty Cycle $\leq 0.01\%$
Holding Current	$I_H$	—	100	mAdc	$T_C = +25^\circ\text{C}$ , Anode Supply = 24 Vdc. Initial Forward Current = 2 Amperes
Thermal Resistance	$R_{\theta JC}$	—	0.4	$^\circ\text{C/Watt}$	Junction-to-Case
Critical Rate-of-Rise of Off-State Voltage. (Higher values may cause device switching.)	dv/dt	200	—	Volts/ $\mu\text{sec}$	$T_J = +125^\circ\text{C}$ , Rated $V_{DRM}$ Using Linear Exponential Rising Waveform, Gate Open Circuited. Exponential dv/dt = $V_{DRM}$ (.632).
Circuit Commutated Turn-Off Time (Typical)	$t_q$	—	80	$\mu\text{sec}$	(1) $T_C = +120^\circ\text{C}$ (2) $I_T = 50\text{ Amps.}$ (3) $V_R = 50\text{ Volts Min.}$ (4) $V_{DRM}$ (Reapplied) = Rated (5) Rate-of-Rise of Reapplied Forward Blocking Voltage = $20\text{ V}/\mu\text{sec}$ (Linear) (6) Gate Bias; 0 Volts, 100 Ohms During Turn-Off Interval (7) Duty Cycle $\leq .01\%$ .
Higher minimum dv/dt selections available, consult factory.					

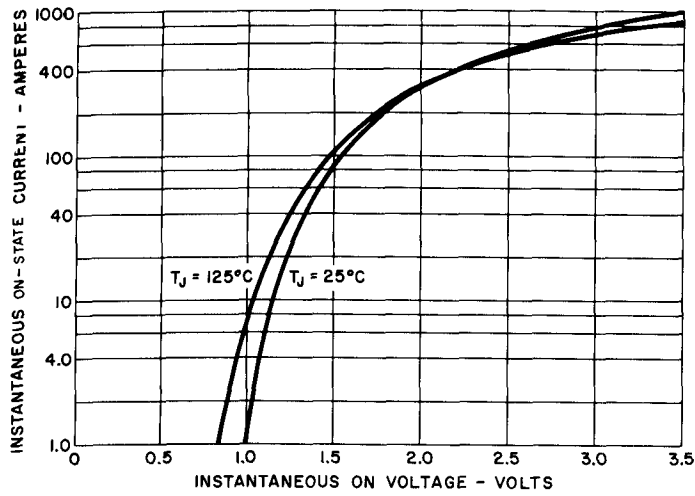

1. MAXIMUM ON-STATE CHARACTERISTICS

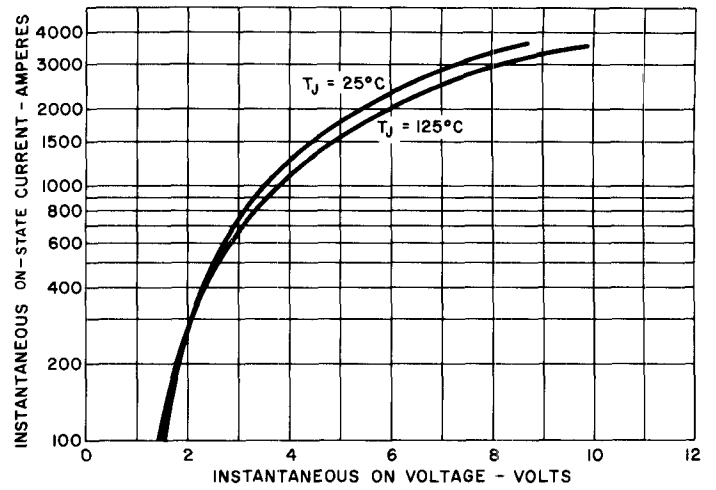

2. MAXIMUM ON-STATE CHARACTERISTICS (HIGH CURRENT LEVEL)

50 TO 400 Hz AC LINE OPERATION

SQUARE WAVE

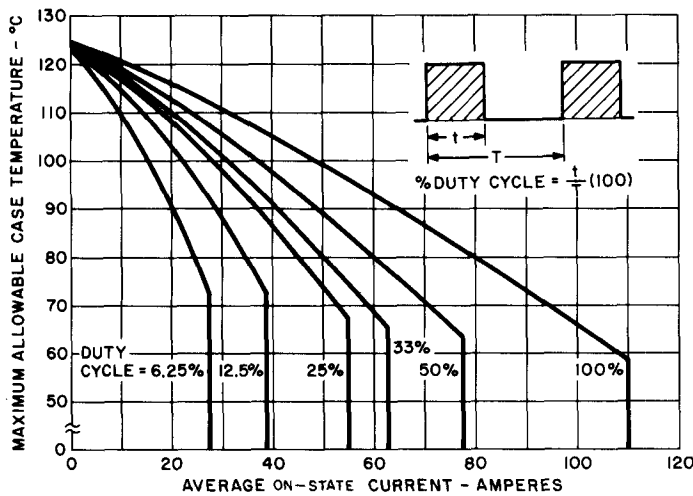

3. MAXIMUM ALLOWABLE CASE TEMPERATURE FOR RECTANGULAR CURRENT WAVEFORM

SINUSOIDAL

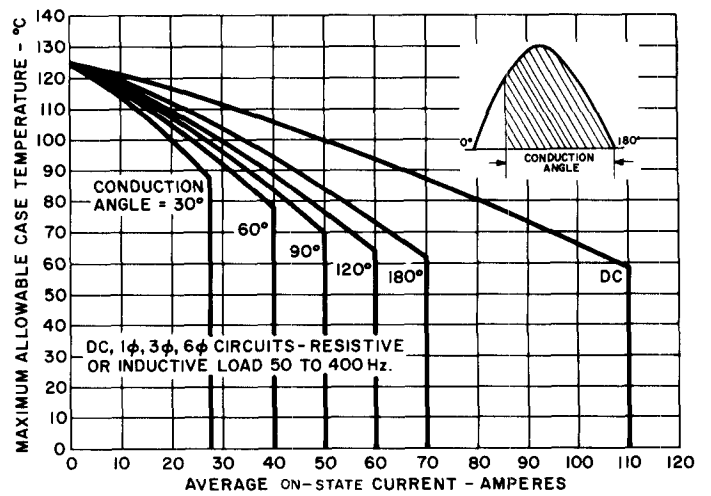

4. MAXIMUM ALLOWABLE CASE TEMPERATURE FOR SINUSOIDAL CURRENT WAVEFORM

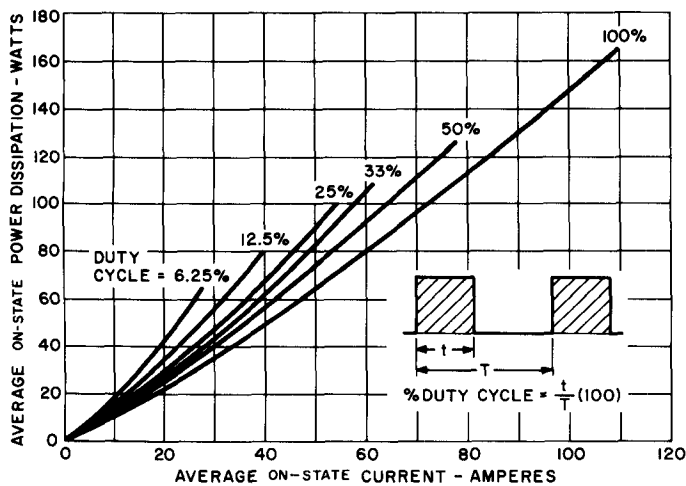

5. MAXIMUM ON-STATE POWER DISSIPATION FOR RECTANGULAR CURRENT WAVEFORM

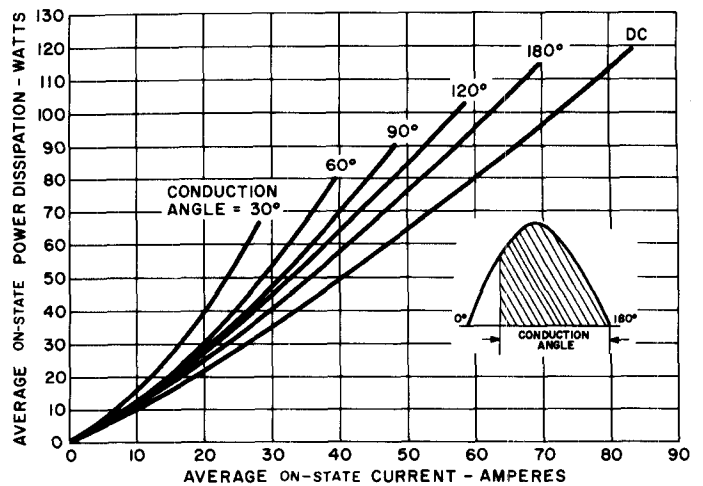

6. MAXIMUM ON-STATE POWER DISSIPATION FOR SINUSOIDAL CURRENT WAVEFORM

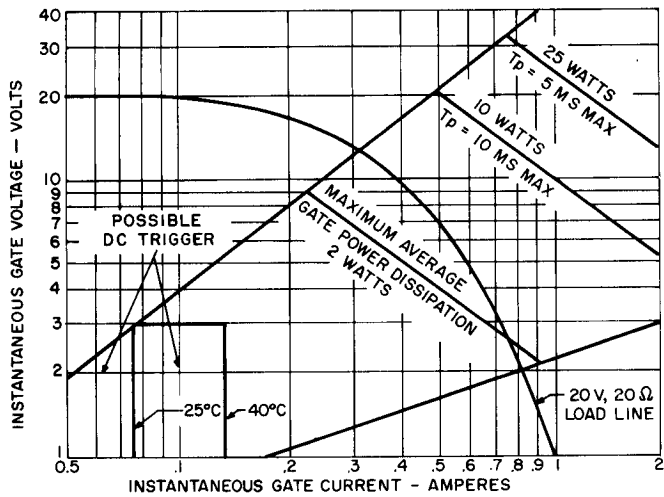

7. GATE TRIGGERING CHARACTERISTICS AND POWER RATINGS

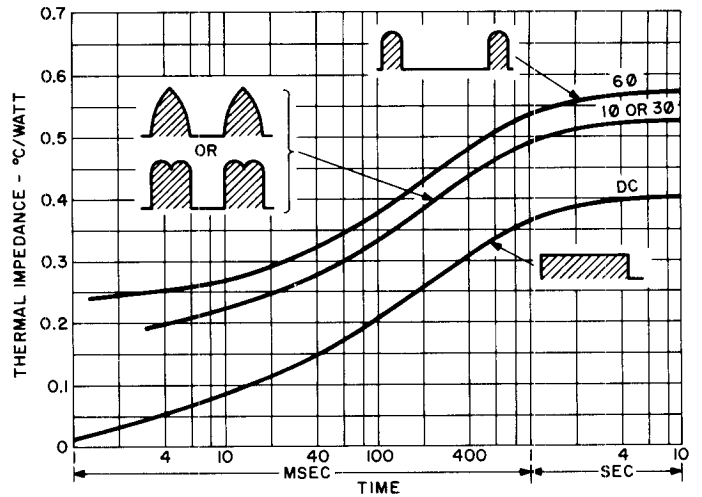

8. TRANSIENT THERMAL IMPEDANCE - JUNCTION-TO-CASE

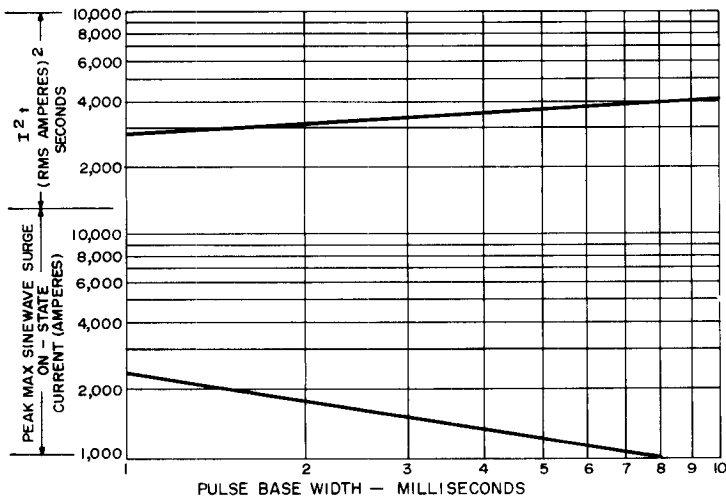

9. SUB-CYCLE SURGE (NON-REPETITIVE) ON-STATE CURRENT AND  $I^2t$  RATING

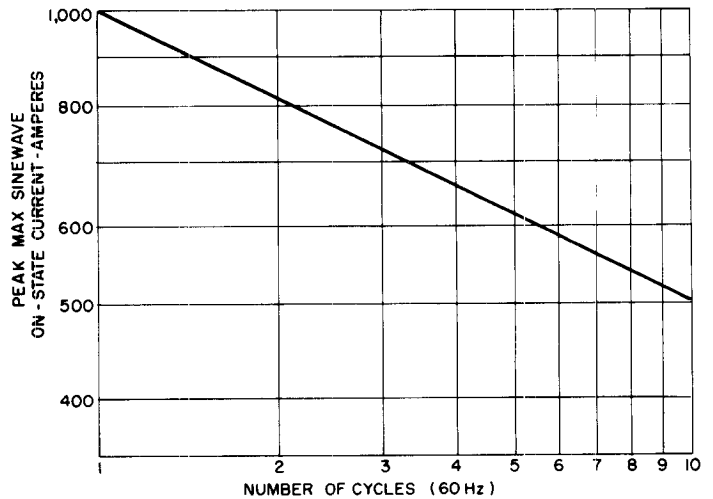

10. SURGE (NON-REPETITIVE) ON-STATE CURRENT

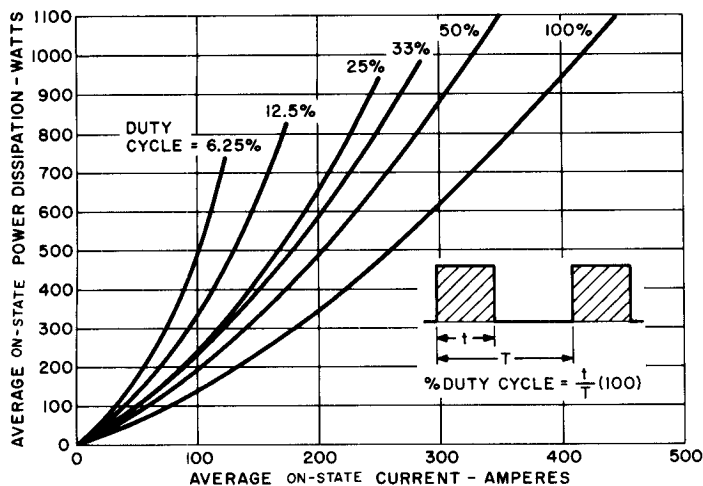

11. MAXIMUM ON-STATE POWER DISSIPATION FOR RECTANGULAR CURRENT WAVEFORM (EXTENDED RANGE)

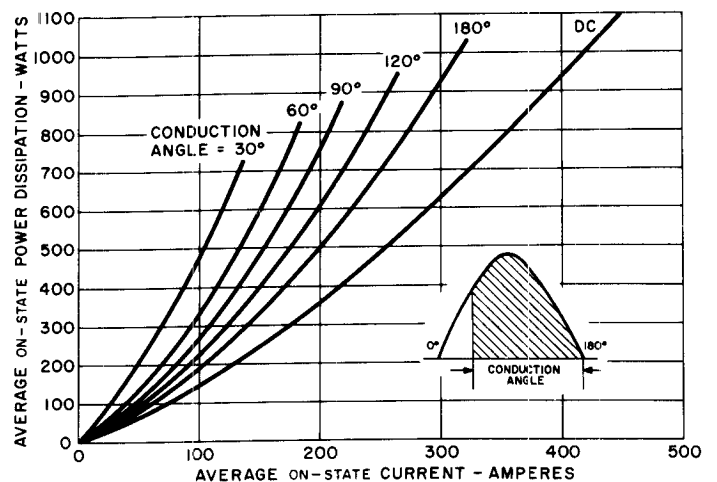

12. MAXIMUM ON-STATE POWER DISSIPATION FOR SINUSOIDAL CURRENT WAVEFORM (EXTENDED RANGE)

OUTLINE DRAWINGS

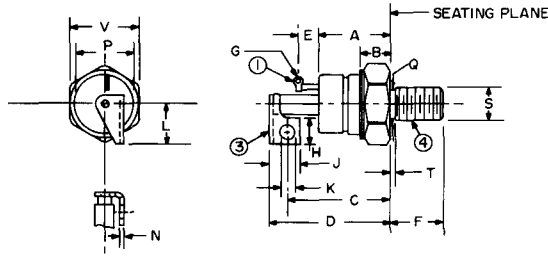

MODEL	TERMINAL ①	TERMINAL ③	TERMINAL ④	S THREAD SIZE
C52	GATE	CATHODE +	ANODE -	1/2-20 UNF-2A

SYM	INCHES		METRIC MM		SYM	INCHES		METRIC MM		NOTES
	MIN.	MAX.	MIN.	MAX.		MIN.	MAX.	MIN.	MAX.	
A	1.020	1.140	25.90	28.96	L	.590	.640	14.98	16.26	
B	.390	.500	9.90	12.70						
C	1.460	REF.	7.92	REF.	N	.058	.070	1.47	1.78	
D	1.660	1.800	42.16	45.72						
E	.312	REF.	7.92	REF.	P	.840	.910	21.33	23.11	
F	.797	.827	20.24	21.01						
G	.060	.075	1.52	1.91	Q	.425	.499	10.79	12.67	
H	.385	.415	9.77	10.54	T	—	.060	—	1.52	2
J	.445	.485	11.30	12.32	V	1.052	1.063	26.72	27.00	
K	.198	.212	5.02	5.38						

NOTES:

- One nut and one lockwasher supplied with each unit. Material of hardware is steel, cad plated.
- "T" dimension is area of unthreaded portion. Complete threads are within 2.5 threads of seating plane.
- Angular orientation of terminals is undefined.

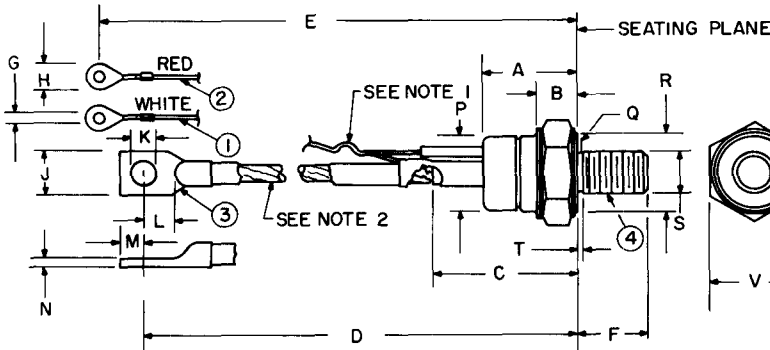

MODEL	TERMINAL ①	TERMINAL ②	TERMINAL ③	TERMINAL ④	S THREAD SIZE
C50	GATE	AUX CATHODE	CATHODE +	ANODE -	1/2 20UNF-2A

SYM	INCHES		METRIC MM		SYM	INCHES		METRIC MM		NOTES
	MIN.	MAX.	MIN.	MAX.		MIN.	MAX.	MIN.	MAX.	
A	1.020	1.140	25.90	28.96	L	.330	—	8.38	—	
B	.390	.500	9.90	12.70	M	.275	.325	6.98	8.26	
C	1.570	1.750	39.87	44.45	N	.065	.095	1.65	2.41	
D	6.000	6.390	152.40	162.31	P	.840	.910	21.33	23.11	
E	6.850	7.500	173.99	190.50	Q	.425	.499	10.79	12.67	
F	.797	.827	20.24	21.01	R	.920	—	23.36	—	4
G	.140	.150	3.55	3.81	T	—	.060	—	1.57	5
H	—	.300	—	7.62						
J	.500	.610	12.70	15.49	V	1.052	1.063	26.72	27.00	
K	.260	.281	6.60	7.14						



NOTES:

- Gate and auxiliary cathode leads supplied lightly twisted together.
- Flexible copper lead.
- One nut and one lockwasher supplied with each unit. Material of hardware is steel, cad plated.
- "R" dimension is diameter of effective seating area.
- "T" dimension is area of unthreaded portion. Complete threads are within 2.5 threads of seating plane.
- Angular orientation of terminals is undefined.

NOTES:

UNIT	WITH HARDWARE		WITHOUT HARDWARE	
	OUNCES	GRAMS	OUNCES	GRAMS
C50	4.25	120	3.50	99
C52	3.50	99	2.75	78