

GENERAL  ELECTRIC
SEMICONDUCTORS
SEMICONDUCTEURS
HALBLEITER

DatasheetDirectory

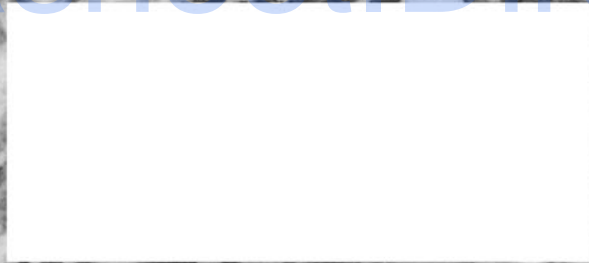

V.0.00.

CONTENTS
SOMMAIRE
INHALT

INDEX	3
INDEX	3
TYPEN-ÜBERSICHT	3
<hr/>	
SILICON SIGNAL TRANSISTORS	5
TRANSISTORS PETITS SIGNAUX AU SILICIUM	5
SILIZIUM-KLEIN-TRANSISTOREN	5
<hr/>	
PROELECTRON TRANSISTORS	14,22
TRANSISTORS – TYPE PROELECTRON	14,22
PROELECTRON – TRANSISTOREN	14,22
<hr/>	
SILICON POWER TRANSISTORS	15
TRANSISTORS DE PUISSANCE AU SILICIUM	15
SILIZIUM-LEISTUNGSTRANSISTOREN	15
<hr/>	
SILICON DIODES	23
DIODES SIGNAL AU SILICIUM	23
SILIZIUM-KLEIN-DIODEN	23
<hr/>	
UNIUNCTIONS, TRIGGER & SWITCHES	26
UNIUNCTIONS ET DISPOSITIFS DE DECLenchEMENT	26
UNIUNCTIONS, SCHALTER UND TRIGGER	26
<hr/>	
OPTOELECTRONICS	31
OPTOELECTRONIQUE	31
OPTOELEKTRONIK	31
<hr/>	
RECTIFIERS	37
DIODES DE REDRESSEMENT	37
GLEICHRICHTER	37
<hr/>	
PHASE CONTROL SCR'S	45
THYRISTORS POUR CONTROLE DE PHASE	45
THYRISTOREN FÜR NETZGEFÜHRTE ANWENDUNGEN	45
<hr/>	
INVERTER SCR'S	54
THYRISTORS RAPIDES	54
THYRISTOREN FÜR FREMDGEFÜHRTE ANWENDUNGEN	54
<hr/>	
TRIACS	62
TRIACS	62
TRIACS	62
<hr/>	
GE-MOV® VARISTORS	66
VARISTANCES GE-MOV®	66
GE-MOV® – VARISTOREN	66
<hr/>	
POWER MODULES	77
MODULES DE PUISSANCE	77
LEISTUNGS – MODULE	77
<hr/>	
PACKAGE OUTLINES	80
BOITIERS	80
GEHÄUSE – BAUFORMEN	80
<hr/>	
SALES OFFICES & DISTRIBUTORS	INSIDE BACK COVER
RESEAUX COMMERCIAUX	VOIR DERNEIRE PAGE
GE-BÜROS UND DISTRIBUTOREN	INWENDIG RÜCKSEITE DECKEL

ELECTRONICS TRADING COMPANY

THE DEMESNE, DUNDALK, COUNTY LOUTH, IRELAND
TELEPHONE: DUNDALK 32371 TELEX: 6500

Prop., General Electric Technical Services Co., Inc.
a Subsidiary of GENERAL ELECTRIC, U.S.A.

Copyright 1978 GENERAL ELECTRIC COMPANY
Semiconductor Products Department
Electronics Park 7-49
Syracuse, New York 13221 U.S.A.

PRINTED IN IRELAND

INDEX

Type	Page	Type	Page	Type	Page	Type	Page	Type	Page
1N248	41	1N3670	40	1N4531	24	2N1912	50	2N5221	6
1N249	41	1N3671	40	1N4532	24	2N1913	50	2N5223	6
1N250	41	1N3272	40	1N4533	24	2N1914	50	2N5225	6
1N914	24	1N3673	40	1N4534	24	2N1915	50	2N5226	6
1N914A	24	1N3735	43	1N4536	24	2N1916	50	2N5227	6
1N914B	24	1N3736	43	1N4606	24	2N2023	50	2N5305	13
1N916	24	1N3737	43	1N4607	25	2N2024	50	2N5306	13
1N916A	24	1N3738	43	1N4608	25	2N2025	50	2N5307	13
1N916B	24	1N3739	43	1N4727	24	2N2026	50	2N5308	13
1N1183	41	1N3740	43	1N4863	24	2N2027	50	2N5777	32
1N1184	41	1N3741	43	1N5059	39	2N2028	50	2N5778	32
1N1185	41	1N3742	43	1N5060	39	2N2029	50	2N5779	32
1N1186	41	1N3743	43	1N5061	39	2N2030	50	2N5780	32
1N1187	41	1N3744	43	1N5062	39	2N2160	28	2N6027	29
1N1188	41	1N3765	41	1N5331	40	2N2322	47	2N6028	29
1N1189	41	1N3766	41	1N5332	41	2N2323	47	3N81	30
1N1190	41	1N3767	41	1N5624	39	2N2324	47	3N82	30
1N1195	41	1N3768	41	1N5625	39	2N2325	47	3N83	30
1N1196	41	1N3879	40	1N5626	39	2N2326	47	3N84	30
1N1197	41	1N3880	40	1N5627	39	2N2327	47	3N85	30
1N1198	41	1N3881	40	1N6264	32	2N2328	47	3N86	30
1N1199	40	1N3882	40	1N6265	32	2N2329	47	4N25	33
1N1200	40	1N3883	40	1N6266	32	2N2344	47	4N26	33
1N1201	40	1N3889	40	2N489	28	2N2345	47	4N27	33
1N1202	40	1N3890	40	2N490	28	2N2346	47	4N28	33
1N1203	40	1N3891	40	2N491	28	2N2347	47	4N29	34
1N1204	40	1N3892	40	2N492	28	2N2348	47	4N30	34
1N1205	40	1N3893	40	2N493	28	2N2646	28	4N31	34
1N1206	40	1N3899	41	2N494	28	2N2647	28	4N32	34
1N1341	40	1N3900	41	2N681	49	2N2840	28	4N33	34
1N1342	40	1N3901	41	2N682	49	2N3870	49	4N35	33
1N1343	40	1N3902	41	2N683	49	2N3871	49	4N36	33
1N1344	40	1N3903	41	2N684	49	2N3872	49	4N37	33
1N1345	40	1N3909	41	2N685	49	2N3873	49	4N38	34
1N1346	40	1N3910	41	2N686	49	2N3877	13	4N39	33
1N1347	40	1N3911	41	2N687	49	2N3896	49	4N40	33
1N1348	40	1N3912	41	2N688	49	2N3897	49	A14*	39
1N1612	40	1N3913	41	2N689	49	2N3898	49	A15*	39
1N1613	40	1N3987	40	2N690	49	2N3899	49	A28*	40
1N1614	40	1N3988	40	2N691	49	2N3903	6, 9, 12	A40*	41
1N1615	40	1N3989	40	2N692	49	2N3904	6, 9, 12	A44*	41
1N1616	40	1N3990	40	2N877	47	2N3905	6, 9, 12	A70*	42
1N2154	41	1N4044	43	2N878	47	2N3906	6, 9, 12	A114*	39
1N2155	41	1N4045	43	2N879	47	2N4123	6, 9	A115*	39
1N2156	41	1N4046	43	2N880	47	2N4124	6, 9	A139*	41
1N2157	41	1N4047	43	2N881	47	2N4125	6, 9	A170*	42
1N2158	41	1N4048	43	2N1595	47	2N4126	6, 9	A177	42
1N2159	41	1N4049	43	2N1596	47	2N4400	6, 9, 12	A180*	42
1N2160	41	1N4050	43	2N1597	47	2N4401	6, 9, 12	A187*	42
1N3208	41	1N4051	43	2N1598	47	2N4402	6, 9, 12	A190*	43
1N3209	41	1N4052	43	2N1599	47	2N4403	6, 9, 12	A197*	43
1N3210	41	1N4053	43	2N1671	28	2N4409	6	A390*	43
1N3211	41	1N4054	43	2N1770	48	2N4410	6	A397*	43
1N3212	41	1N4055	43	2N1771	48	2N4983	30	A430*	44
1N3213	41	1N4056	43	2N1772	48	2N4984	30	A437*	44
1N3214	41	1N4148	24	2N1773	48	2N4985	30	A500*	43
1N3260	42	1N4149	24	2N1774	48	2N4986	30	A540*	44
1N3261	42	1N4150	24	2N1775	48	2N4987	30	A570*	44
1N3262	42	1N4151	24	2N1776	48	2N4988	30	A596*	44
1N3263	42	1N4152	24	2N1777	48	2N4989	30	A640	44
1N3264	42	1N4153	24	2N1778	48	2N4990	30	A696*	44
1N3265	42	1N4154	24	2N1792	50	2N4991	30	BC*	14
1N3266	42	1N4245	39	2N1793	50	2N4992	30	BD*	22
1N3267	42	1N4246	39	2N1794	50	2N4993	30	BPW*	35
1N3268	42	1N4147	39	2N1795	50	2N5060	47	C3*	47
1N3269	42	1N4248	39	2N1796	50	2N5061	47	C5*	47
1N3270	42	1N4249	39	2N1797	50	2N5062	47	C6*	47
1N3271	42	1N4305	24	2N1798	50	2N5063	47	C7*	47
1N3272	42	1N4444	24	2N1842	48	2N5064	47	C10*	48
1N3273	42	1N4446	24	2N1843	48	2N5088	6	C11*	48
1N3274	42	1N4447	24	2N1844	48	2N5089	6	C15*	48
1N3275	42	1N4448	24	2N1845	48	2N5174	13	C35*	48
1N3289	42	1N4449	24	2N1846	48	2N5175	13	C36*	48
1N3290	42	1N4450	24	2N1847	48	2N5176	13	C37*	48
1N3291	42	1N4451	25	2N1848	48	2N5204	49	C38*	49
1N3292	42	1N4454	24	2N1849	48	2N5205	49	C45*	50
1N3293	42	1N4510	40	2N1850	48	2N5206	49	C46*	50
1N3294	42	1N4511	40	2N1909	50	2N5207	49	C48*	56
1N3295	42	1N4529	41	2N1910	50	2N5219	6	C49*	56
1N3296	42	1N4530	41	2N1911	50	2N5220	6	C50*	50

INDEX (Continued)

Type	Page	Type	Page	Type	Page	Type	Page	Type	Page
C52*	50	C431	52	DA1703	24	GES5817	7, 9	MA1701	24
C60*	50	C434*	59	DA1704	24	GES5818	7, 9	MA1702	24
C62*	50	C435	59	DE104	25	GES5819	8, 9	MA1703	24
C103*	47	C438*	59	DE110	25	GES5820	8, 9	MA1704	24
C106*	47	C438-8*	59	DE111	25	GES5821	8, 9	MPSA05	8, 10
C107*	47	C440	52	DE112	25	GES5822	7, 9	MPSA06	8, 10
C108*	47	C441	52	DE113	25	GES5823	7, 9	MPSA12	8
C122*	48	C444*	59	DE114	25	GES5824	7	MPSA13	8
C126	48	C445*	59	DE115	25	GES5825	7	MPSA14	8
C127*	48	C447*	59	DT230*	25, 39	GES5826	7	MPSA20	8
C137*	49	C448*	59						
C138*	55	C450*	53	DZ800	24	GES5827	7	MPSA55	8, 10
C139*	55	C451	53	DZ805	24	GES5827A	11	MPSA56	8, 10
C140*	55	C501*	51	DZ806	24	GES5828	7	MPSA65	8
C141*	55	C502*	51	G* Heatsinks	61	GES5828A	11	MPSA66	8
C144	55	C601	52	GE5060	21	GES5869	9	MPSA70	8
C147*	50	C602	52	GE5061	21	GES6000	7, 11, 12	MPS3638	8, 12
C148*	56	C612*	60	GE5062	22	GES6001	7, 9, 11, 12	MPS3638A	8, 12
C149*	56	C613*	60	GE6060	21	GES6002	7, 9, 12	MPS3702	8, 10
C150*	50	C648*	60	GE6061	21	GES6003	7, 9, 12	MPS3703	8, 10
C152*	50	C701	53	GE6062	21	GES6004	7, 9, 11, 12	MPS3704	8, 10
				GER4001	39				
C154*	56	C702	53	GER4002	39	GES6005	7, 9, 11, 12	MPS3705	8, 10
C155*	56	C712*	60	GER4003	39	GES6006	7, 9, 12	MPS3706	8, 10
C156*	56	C782	53	GER4004	39	GES6007	7, 9, 12	MPS5172	8, 10
C157*	56	CNY*	35	GER4005	39	GES6010	7, 9, 11, 12	MPS6076	8, 10
C158*	56	CQX*	35	GER4006	39	GES6011	7, 9, 11, 12	MPS6512	8, 10
C159*	56	D5J*	28	GER4007	39	GES6012	7, 9, 11, 12	MPS6513	8, 10
C164*	56	D5K*	29	GES929	6, 11	GES6013	7, 9, 11, 12	MPS6514	8, 10
C165*	56	D16P*	13	GES930	6, 11	GES6014	7, 9, 11, 12	MPS6516	8, 10
C180*	51	D38L*	8, 10	GES2221	6, 9	GES6015	7, 9, 11, 12	MPS6517	8, 10
C180X500	51	D38L*	8, 10, 13	GES2221A	6, 12	GES6016	7, 9, 11, 12	MPS6518	8, 10
		D38S*	8, 11						
C184*	57			GES2222	6, 9	GES6017	7, 9, 11, 12	MPS6530	8, 10
C185*	57	D38W*	8, 11	GES2222A	6, 12	GES6218	7, 13	MPS6531	8, 10
C186*	57	D28Y*	8	GES2483	6	GES6219	7, 13	MPS6532	8, 10
C203*	47	D39C*	8, 10, 13	GES2906	6, 9, 12	GES6220	7, 13	MPS6533	8, 10
C220*	48	D39J*	8, 10	GES2907	6, 9, 12	GES6221	7, 13	MPS6534	8, 10
C228*	49	D40C*	15	GES5305	6, 13	GES9000	9	MPS6535	8, 10
C230*	49	D40D*	18	GES5306	6, 13	H11A*	33	MPS6565	8
C231*	49	D40E*	18	GES5306A	11, 13	H11A10*	34	MPS6566	8
C234*	55	D40K*	15	GES5307	6, 13	H11A520	33	SC116*	64
C235*	55	D40P*	17	GES5308	6, 13	H11A550	33	SC136*	64
		D40V*	17						
C350*	50			GES5308A	11, 13	H11A5100	33	SC140*	64
C354*	56	D41D*	18	GES5368	6, 9, 12	H11AA*	34	SC141*	64
C355*	56	D41E*	18	GES5369	6, 12	H11B*	34	SC142*	64
C358	56	D41K*	18	GES5370	6, 9, 12	H11B255	34	SC143*	64
C364*	57	D42C*	19	GES5371	6, 9, 12	H11C*	33	SC146*	64
C365*	57	D42D*	15	GES5372	6, 9, 12	H11D*	33	SC147*	64
C380*	51	D42T*	17	GES5373	6, 9, 12	H13A*	33	SC149*	64
C384*	57	D43C*	19	GES5374	6, 9, 12	H13B*	33	SC151*	64
C385*	57	D43D*	15	GES5375	6, 9, 12	H15A*	33	SC160*	64
		D44C*	20	GES5447	7, 9	H15B*	33	SC240*	65
C387*	58	D44D*	16						
C388*	58			GES5448	7, 9	H17A*	33	SC241*	65
C390*	51	D44E*	16	GES5449	7, 9	H17B*	33	SC245*	65
C391	51	D44H*	21	GES5450	7, 9	H20A*	33	SC246*	65
C392*	58	D44Q*	17	GES5451	7, 9	H20B*	33	SC250*	65
C393*	58	D44T*	17	GES5810	7, 9	H74A1	33	SC251*	65
C394*	59	D45C*	20	GES5811	7, 9	H74C*	33	SC260*	65
C395*	59	D45D*	16	GES5812	7, 9	L8*	32	SC261*	65
C397*	58	D45E*	16	GES5813	7, 9	L9*	32	SC265*	65
C398*	58	D45H	21	GES5814	7, 9	L14*	32	SC266*	65
C430*	52	D64TS*	21	GES5815	7, 9	LED55*	32	V* Varistors	70-76
		DA1701	24	GES5816	7, 9	LED56*	32	WV*	77, 78
		DA1702	24						

* Denotes Series

TRANSISTORS
TRANSISTORS
TRANSISTOREN

V_{CEO}	MAXIMUM COLLECTOR EMITTER VOLTAGE TENSION MAXIMALE EMETTEUR-COLLECTEUR MAX. KOLLEKTOR-EMITTER-SPANNUNG
h_{FE}	D.C. CURRENT GAIN GAIN EN COURANT STROMVERSTÄRKUNG
C_{cb}	COLLECTOR BASE CAPACITANCE CAPACITE COLLECTEUR BASE KOLLEKTOR-BASIS-KAPAZITÄT
P_T	MAX. POWER DISSIPATION PUISSANCE DISSIPEE MAX. MAX. VERLUSTLEISTUNG
$V_{CE(SAT)}$	COLLECTOR EMITTER SATURATION VOLTAGE TENSION DE SATURATION (COLLECTEUR EMETTEUR) KOLLEKTOR-EMITTER-SÄTTIGUNGSSPANNUNG
I_C	COLLECTOR CURRENT COURANT COLLECTEUR KOLLEKTORSTROM
I_B	BASE CURRENT COURANT BASE BASISSTROM
V_{BE}	BASE EMITTER VOLTAGE TENSION BASE EMETTEUR EMITTER-BASIS-SPANNUNG
F_T	CUT-OFF FREQUENCY FREQUENCE DE COUPURE GRENZFREQUENZ
t_{ON}	RISE TIME TEMPS DE MONTEE ANSTIEGSZEIT
t_F	FALL TIME TEMPS DE DESCENTE ABFALLZEIT

**SILICON SIGNAL TRANSISTORS
GENERAL PURPOSE AMPLIFIERS
TO-92 PACKAGE**

TRANSISTORS AMPLIFICATEURS
- PETITS SIGNAUX AU SILICIUM
BOITIER TO-92

SILIZIUM-SIGNAL-TRANSISTOREN
ALLGEMEINE VERSTÄRKER-TYPEN
TO-92 GEHÄUSE

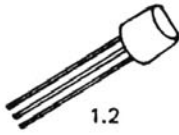

1.2

Device	Type	BV _{CEO} @ 10mA (V)		h _{FE}		V _{CE(sat)}			f _T Typical (MHz)	C _{cb} @ 10V 1 MHz Typical (P _F)	I _C Continuous (mA)	P _T @ 25°C (mW)	
		Min.	Max.	Max. @ I _C (mA)	V _{CE} (V)	Max. @ I _C (mA)	I _B (mA)						
2N3903	NPN	40	50	150	10	1	.3	50	5	300	2.5	200	350
2N3904	NPN	40	100	300	10	1	.3	50	5	350	2.5	200	350
2N3905	PNP	40	50	150	10	1	.4	50	5	250	2.5	200	350
2N3906	PNP	40	100	300	10	1	.4	50	5	300	2.5	200	350
2N4123	NPN	30	50	150	2	1	.3	50	5	300	2.5	200	350
2N4124	NPN	25	120	360	2	1	.3	50	5	350	2.5	200	350
2N4125	PNP	30	50	150	2	1	.4	50	5	250	2.5	200	350
2N4126	PNP	25	120	360	2	1	.4	50	5	300	2.5	200	350
2N4400	NPN	40	50	150	150	1	.4	150	15	225	3.5	600	350
2N4401	NPN	40	100	300	150	1	.4	150	15	275	3.5	600	350
2N4402	PNP	40	50	150	150	2	.4	150	15	300	5.0	600	350
2N4403	PNP	40	100	300	150	2	.4	150	15	350	5.0	600	350
2N4409	NPN	50	60	400	10	1	.2	1	.1	100	5.0	250	625
2N4410	NPN	80	60	400	10	1	.2	1	.1	100	5.0	250	625
2N5088	NPN	30	300	900	.1	5	.5	10	1	75	2.0	50	350
2N5089	NPN	25	400	1200	.1	5	.5	10	1	75	2.0	50	350
2N5219	NPN	15	35	500	2	10	.4	10	1	200	2.0	100	350
2N5220	NPN	15	30	600	50	10	.5	150	15	125	5.0	500	350
2N5221	PNP	15	30	600	50	10	.5	150	15	125	7.0	500	350
2N5223	NPN	20	50	800	2	10	.7	10	1	200	2.0	100	350
2N5225	NPN	25	30	600	50	10	.8	100	10	75	6.0	200	350
2N5226	PNP	25	30	600	50	10	.8	100	10	100	7.0	500	350
2N5227	PNP	30	50	700	2	10	.4	10	1	125	4.0	50	350
GES929	NPN	50	60	120	.01	5	.125	10	1	100	2.0	100	360
GES930	NPN	50	100	300	.01	5	.125	10	1	100	2.0	100	360
GES2221	NPN	30	40	120	150	10	.3	150	15	275	3.5	400	360
GES2221A	NPN	40	40	120	150	10	.3	150	15	275	3.5	400	360
GES2222	NPN	30	100	300	150	10	.3	150	15	275	3.5	400	360
GES2222A	NPN	40	100	300	150	10	.3	150	15	325	3.5	400	360
GES2483	NPN	60	75	-	.1	5	.125	10	1	100	2.0	100	360
GES2906	PNP	40	40	120	150	10	.4	150	15	225	3.0	350	360
GES2907	PNP	40	100	300	150	10	.4	150	15	225	3.0	350	360
GES5305	NPN	25	2K	20K	2	5	1.4	200	.2	50	3.5	300	400
GES5306	NPN	25	7K	70K	2	5	1.4	200	.2	50	3.5	300	400
GES5307	NPN	40	2K	20K	2	5	1.4	200	.2	50	3.5	300	400
GES5308	NPN	40	7K	70K	2	5	1.4	200	.2	50	3.5	300	400
GES5368	NPN	30	60	200	150	10	.3	150	15	200	3.5	500	360
GES5369	NPN	30	100	300	150	10	.3	150	15	200	3.5	500	360
GES5370	NPN	30	200	600	150	10	.3	150	15	200	3.5	500	360
GES5371	NPN	30	60	600	150	10	.3	150	15	200	3.5	500	360
GES5372	PNP	30	40	200	150	10	.3	150	15	200	4.0	500	360
GES5373	PNP	30	100	300	150	10	.3	150	15	200	4.0	500	360
GES5374	PNP	30	200	400	150	10	.3	150	15	200	4.0	500	360

SILICON SIGNAL TRANSISTORS
GENERAL PURPOSE AMPLIFIERS
TO-92 PACKAGE

TRANSISTORS AMPLIFICATEURS
PETITS SIGNAUX AU SILICIUM
BOITIER TO-92

SILIZIUM-SIGNAL-TRANSISTOREN
ALLGEMEINE VERSTÄRKER-TYPEN
TO-92 GEHÄUSE

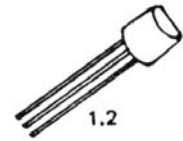

Device	Type	BV _{CEO} @ 10mA		h _{FE}		V _{CE(sat)}			f _T	C _{cb} @ 10V	I _C	P _T	
		(V)	Min.	Max. @ I _C (mA)			V _{CE} (V)	Max. @ I _C (mA)	I _B (mA)	Typical (MHz)	1 MHz Typical (P _F)	Continuous (mA)	@ 25°C (mW)
GES5822	NPN	60	100	200	2	2	.75	500	50	150	6.0	750	500
GES5823	PNP	60	100	200	2	2	.75	500	50	150	8.0	750	500
GES5824	NPN	40	60	120	2	5	.125	10	1	100	2.0	100	360
GES5825	NPN	40	100	200	2	5	.125	10	1	100	2.0	100	360
GES5826	NPN	40	150	300	2	5	.125	10	1	100	2.0	100	360
GES5827	NPN	40	250	500	2	5	.125	10	1	100	2.0	100	360
GES5828	NPN	40	400	800	2	5	.125	10	1	10	2.0	100	360
GES6000	NPN	25	100	300	10	1	.2	100	10	150	6.0	500	400
GES6001	PNP	25	100	300	10	1	.4	100	10	250	8.0	500	400
GES6002	NPN	25	200	500	10	1	.2	100	10	170	6.0	500	400
GES6003	PNP	25	200	500	10	1	.4	100	10	250	8.0	500	400
GES6004	NPN	40	100	300	10	1	.2	100	10	150	6.0	500	400
GES6005	PNP	40	100	300	10	1	.4	100	10	250	8.0	500	400
GES6006	NPN	40	200	500	10	1	.2	100	10	170	6.0	500	400
GES6007	PNP	40	200	500	10	1	.4	100	10	250	8.0	500	400
GES6010	NPN	40	100	300	10	1	.5	500	50	125	6.0	800	500
GES6011	PNP	40	100	300	10	1	.75	500	50	100	8.0	800	500
GES6012	NPN	40	200	500	10	1	.5	500	50	150	6.0	800	500
GES6013	PNP	40	200	500	10	1	.75	500	50	125	8.0	800	500
GES6014	NPN	60	100	300	10	1	.5	500	50	125	6.0	800	500
GES6015	PNP	60	100	300	10	1	.75	500	50	100	8.0	800	500
GES6016	NPN	60	200	500	10	1	.5	500	50	150	6.0	800	500
GES6017	PNP	60	200	500	10	1	.75	500	50	125	8.0	800	500
GES6218	NPN	300	20	—	20	10	1.0	10	1	65	4.0	50	500
GES6219	NPN	350	20	—	20	10	1.0	10	1	65	4.0	50	500
GES6220	NPN	200	20	—	20	10	2.0	20	2	65	4.0	50	500
GES6221	NPN	150	20	—	20	10	2.3	20	2	65	4.0	50	500
GES6222	NPN	60	75	200	2	5	.125	10	1	100	2.0	100	360
GES6224	NPN	60	150	300	2	5	.125	10	1	100	2.0	100	360
GES5375	PNP	30	40	400	150	10	.3	150	15	200	4.0	500	360
GES5447	PNP	25	60	300	50	5	.25	50	5	150	5.0	200	360
GES5448	PNP	30	30	150	50	5	.25	50	5	150	5.0	200	360
GES5449	NPN	30	100	300	50	2	.6	100	5	100	6.0	800	360
GES5450	NPN	30	50	150	50	2	.8	100	5	100	6.0	800	360
GES5451	NPN	20	30	600	50	2	1.0	100	5	100	6.0	800	360
GES5810	NPN	25	60	200	2	2	.75	500	50	125	6.0	750	500
GES5811	PNP	25	60	200	2	2	.75	500	50	125	8.0	750	500
GES5812	NPN	25	150	500	2	2	.75	500	50	150	6.0	750	500
GES5813	PNP	25	150	500	2	2	.75	500	50	150	8.0	750	500
GES5814	NPN	40	60	160	2	2	.75	500	50	125	6.0	750	500
GES5815	PNP	40	60	160	2	2	.75	500	50	125	8.0	750	500
GES5816	NPN	40	100	200	2	2	.75	500	50	150	6.0	750	500
GES5817	PNP	40	100	200	2	2	.75	500	50	150	8.0	750	500
GES5818	NPN	40	150	300	2	2	.75	500	50	150	6.0	750	500

**SILICON SIGNAL TRANSISTORS
GENERAL PURPOSE AMPLIFIERS
TO-92 PACKAGE**

TRANSISTORS AMPLIFICATEURS
PETITS SIGNAUX AU SILICIUM
BOITIER TO-92

SILIZIUM-SIGNAL-TRANSISTOREN
ALLGEMEINE VERSTÄRKER-TYPEN
TO-92 GEHÄUSE

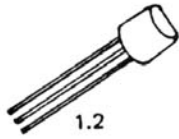

Device	Type	BV _{CEO} @ 10mA (V)		h _{FE}		V _{CE(sat)}			f _T	C _{cb} @ 10V	I _C	P _T	
		Min.	Max.	Max. @ I _C (mA)	V _{CE} (V)	Max. @ I _C (mA)	I _B (mA)	Typical (MHz)	1 MHz Typical (P _F)	Continuous (mA)	@ 25°C (mW)		
GES5819	PNP	40	150	300	2	2	.75	500	50	150	8.0	750	500
GES5820	NPN	60	60	160	2	2	.75	500	50	125	6.0	750	500
GES5821	PNP	60	60	160	2	2	.75	500	50	125	8.0	750	500
MPSA05	NPN	60	50	—	100	1	.25	100	10	100	7.0	500	625
MPSA06	NPN	80	50	—	100	1	.25	100	10	100	7.0	500	625
MPSA12	NPN	20	20,000	—	10	5	1.0	10	.01	50	4.0	500	625
MPSA13	NPN	30	10,000	—	100	5	1.5	100	.1	50	4.0	500	625
MPSA14	NPN	30	20,000	—	100	5	1.5	100	.1	50	4.0	500	625
MPSA20	NPN	40	40	400	5	10	.25	10	1	140	2.0	100	350
MPSA55	PNP	60	50	—	100	1	.25	100	10	100	11.0	500	625
MPSA56	PNP	80	50	—	100	1	.25	100	10	100	11.0	500	625
MPSA65	PNP	30	50,000	—	10	5	1.5	10	.1	100	6.0	300	625
MPSA66	PNP	30	75,000	—	10	5	1.5	10	.1	100	6.0	300	625
MPSA70	PNP	40	40	400	5	10	.25	10	1	150	3.5	100	350
MPS3638	PNP	25	30	—	50	1	.25	50	2.5	125	5.0	500	350
MPS3638A	PNP	25	100	—	50	1	.25	50	2.5	175	5.0	500	350
MPS3702	PNP	25	60	300	50	5	.25	50	5	150	5.0	200	360
MPS3703	PNP	30	30	150	50	5	.25	50	5	150	5.0	200	360
MPS3704	NPN	30	100	300	50	2	.6	100	5	100	6.0	800	360
MPS3705	NPN	30	50	150	50	2	.8	100	5	100	6.0	800	360
MPS3706	NPN	20	30	600	50	2	1.0	100	5	100	6.0	800	360
MPS5172	NPN	25	100	500	10	10	.25	10	1	100	5.0	100	360
MPS6076	PNP	25	100	500	10	10	.25	10	1	100	5.0	100	360
MPS6512	NPN	30	50	100	2	10	.5	50	5	275	2.0	100	350
MPS6513	NPN	30	90	180	2	10	.5	50	5	275	2.0	100	350
MPS6514	NPN	25	150	300	2	10	.5	50	5	425	2.0	100	350
MPS6516	PNP	40	50	100	2	10	.5	50	5	225	2.5	100	350
MPS6517	PNP	40	90	180	2	10	.5	50	5	225	2.5	100	350
MPS6518	PNP	40	150	300	2	10	.5	50	5	350	2.5	100	350
MPS6530	NPN	40	25	—	500	10	.5	100	10	250	3.5	600	350
MPS6531	NPN	40	50	—	500	10	.3	100	10	250	3.5	600	350
MPS6532	NPN	30	30	—	100	1	.5	100	10	250	3.5	600	350
MPS6533	PNP	40	25	—	500	10	.5	100	10	350	5.0	600	350
MPS6534	PNP	40	50	—	500	10	.3	100	10	350	5.0	600	350
MPS6535	PNP	30	30	—	100	1	.5	100	10	350	5.0	600	350
MPS6565	NPN	45	40	160	10	10	.4	10	1	225	2.0	200	350
MPS6566	NPN	45	100	100	400	10	.4	10	1	225	2.0	200	350
D39C1-6	PNP	25/40	2,000	70,000	—	2	1.5	500	.5	90	5.0	500	500
D38H1-6	NPN	60/80	60	500	10	1	.125	100	10	100	7.0	500	500
D39J1-6	PNP	60/80	60	500	10	1	.26	100	10	80	10.0	500	500
D38L1-6	NPN	25/40	2,000	70,000	2	5	1.75	500	.5	90	5.0	500	500
D38S1-10	NPN	30/60	400	3,000	.10	5	.1	10	.5	200	2.0	100	400
D38Y1-3	NPN	200/300	30	—	20	10	1.0	40	4	100	5.0	100	500
D38W5-11	NPN	80	150	1,200	.1	5	.1	10	1	250	2.0	100	400

**SILICON SIGNAL TRANSISTORS
COMPLEMENTARY PAIRS
TO-92 PACKAGE**

TRANSISTORS COMPLEMENTAIRES
AU SILICIUM
BOITIER TO-92

SILIZIUM-SIGNAL-TRANSISTOREN
KOMPLEMENTÄRTYPEN
TO-92 GEHÄUSE

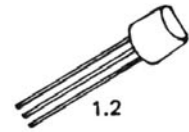

DEVICE		BV _{CEO} (V)	h _{FE}		V _{CE(SAT)}		COMPLEMENT
NPN	PNP		MIN.-MAX.	@ I _C , V _{CE} (V)	(V) MAX.	@ I _C , I _B	
2N3903		40	50-150	10mA, 1	0.3	50mA, 5mA	2N3905
2N3904		40	100-300	10mA, 1	0.3	50mA, 5mA	2N3906
	2N3905	40	50-150	10mA, 1	0.4	50mA, 5mA	2N3903
	2N3906	40	100-300	10mA, 1	0.4	50mA, 5mA	2N3904
2N4400		40	50-150	150mA, 1	0.4	150mA, 15mA	2N4402
2N4401		40	100-300	150mA, 1	0.4	150mA, 15mA	2N4403
	2N4402	40	50-150	150mA, 2	0.4	150mA, 15mA	2N4400
	2N4403	40	100-300	150mA, 2	0.4	150mA, 15mA	2N4401
2N4123		30	50-150	2mA, 1	0.3	50mA, 5mA	2N4125
2N4124		25	120-360	2mA, 1	0.3	50mA, 5mA	2N4126
	2N4125	30	50-150	2mA, 1	0.4	50mA, 5mA	2N4123
	2N4126	25	120-360	2mA, 1	0.4	50mA, 5mA	2N4124
GES5368		30	60-200	150mA, 10	0.3	150mA, 15mA	GES5372
GES5369		30	100-300	150mA, 10	0.3	150mA, 15mA	GES5373
GES5370		30	200-600	150mA, 10	0.3	150mA, 15mA	GES5374
GES5371		30	60-600	150mA, 10	0.3	150mA, 15mA	GES5375
	GES5372	30	40-200	150mA, 10	0.3	150mA, 15mA	GES5368
	GES5373	30	100-300	150mA, 10	0.3	150mA, 15mA	GES5369
	GES5374	30	200-400	150mA, 10	0.3	150mA, 15mA	GES5370
	GES5375	30	40-400	150mA, 10	0.3	150mA, 15mA	GES5371
	GES5447	25	60-300	50mA, 5	0.25	50mA, 5mA	GES5449
	GES5448	30	30-150	50mA, 5	0.25	50mA, 5mA	GES5450
GES5449		30	100-300	50mA, 2	0.6	100mA, 5mA	GES5447
GES5450		30	50-150	50mA, 2	0.8	100mA, 5mA	GES5448
GES5451		20	30-600	50mA, 2	1.0	100mA, 5mA	GES5447
GES5810		25	60-200	2mA, 2	0.75	500mA, 50mA	GES5811
	GES5811	25	60-200	2mA, 2	0.75	500mA, 50mA	GES5810
GES5812		25	150-500	2mA, 2	0.75	500mA, 50mA	GES5813
	GES5813	25	150-500	2mA, 2	0.75	500mA, 50mA	GES5812
GES5814		40	60-160	2mA, 2	0.75	500mA, 50mA	GES5815
	GES5815	40	60-160	2mA, 2	0.75	500mA, 50mA	GES5814
GES5816		40	100-200	2mA, 2	0.75	500mA, 50mA	GES5817
	GES5817	40	100-200	2mA, 2	0.75	500mA, 50mA	GES5816
GES5818		40	150-300	2mA, 2	0.75	500mA, 50mA	GES5819
	GES5819	40	150-300	2mA, 2	0.75	500mA, 50mA	GES5818
GES5820		60	60-160	2mA, 2	0.75	500mA, 50mA	GES5821
	GES5821	60	60-160	2mA, 2	0.75	500mA, 50mA	GES5820
GES5822		60	100-200	2mA, 2	0.75	500mA, 50mA	GES5823
	GES5823	60	100-200	2mA, 2	0.75	500mA, 50mA	GES5822
GES6000		25	100-300	10mA, 1	0.2	100mA, 30mA	GES6001
	GES6001	25	100-300	10mA, 1	0.4	100mA, 10mA	GES6000
GES6002		25	200-500	10mA, 1	0.2	100mA, 10mA	GES6003
	GES6003	25	200-500	10mA, 1	0.4	100mA, 10mA	GES6002
GES6004		40	100-300	10mA, 1	0.2	100mA, 10mA	GES6005
	GES6005	40	100-300	10mA, 1	0.4	100mA, 10mA	GES6004
GES6006		40	200-500	10mA, 1	0.2	100mA, 10mA	GES6007
	GES6007	40	200-500	10mA, 1	0.4	100mA, 10mA	GES6006
GES6010		40	100-300	10mA, 1	0.5	500mA, 50mA	GES6011
	GES6011	40	100-300	10mA, 1	0.75	500mA, 50mA	GES6010
GES6012		40	200-500	10mA, 1	0.5	500mA, 50mA	GES6013
	GES6013	40	200-500	10mA, 1	0.75	500mA, 50mA	GES6012
GES6014		60	100-300	10mA, 1	0.5	500mA, 50mA	GES6015
	GES6015	60	100-300	10mA, 1	0.75	500mA, 50mA	GES6014
GES6016		60	200-500	10mA, 1	0.5	500mA, 50mA	GES6017
	GES6017	60	200-500	10mA, 1	0.75	500mA, 50mA	GES6016
GES2221		30	40-120	150, 10	0.3	150mA, 15mA	GES2906
GES2222		30	100-300	150, 10	0.3	150mA, 15mA	GES2907
	GES2906	40	40-120	150, 10	0.4	150mA, 15mA	GES2221
	GES2907	40	100-300	150, 10	0.4	150mA, 15mA	GES2222

**SILICON SIGNAL TRANSISTORS
COMPLEMENTARY PAIRS
TO-92 PACKAGE**

TRANSISTORS COMPLEMENTAIRES
AU SILICIUM
BOITIER TO-92

SILIZIUM-SIGNAL-TRANSISTOREN
KOMPLEMENTÄRTYPEN
TO-92 GEHÄUSE

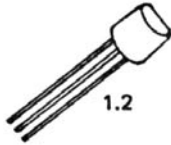

DEVICE		BV _{CEO} (V)	h _{FE}		V _{CE(SAT)}		COMPLEMENT
NPN	PNP		MIN.-MAX.	@ I _C , V _{CE} (V)	(V) MAX.	@ I _C , I _B	
MPS A05		60	50-	100mA, 1	0.25	100mA, 10mA	MPS A55
MPS A06		80	50-	100mA, 1	0.25	100mA, 10mA	MPS A56
	MPS A55	60	50-	100mA, 1	0.25	100mA, 10mA	MPS A05
	MPS A56	80	50-	100mA, 1	0.25	100mA, 10mA	MPS A06
	MPS3702	25	60-300	50mA, 5	0.25	50mA, 5mA	MPS3704
	MPS3703	30	30-150	50mA, 5	0.25	50mA, 5mA	MPS3705
MPS3704		30	100-300	50mA, 2	0.6	100mA, 5mA	MPS3702
MPS3705		30	50-150	50mA, 2	0.8	100mA, 5mA	MPS3703
MPS3706		20	30-600	50mA, 2	1.0	100mA, 5mA	MPS3702
MPS6512		30	50-100	2mA, 10	0.5	50mA, 5mA	MPS6516
MPS6513		30	90-180	2mA, 10	0.5	50mA, 5mA	MPS6517
MPS6514		25	150-300	2mA, 10	0.5	50mA, 5mA	MPS6518
	MPS6516	40	50-100	2mA, 10	0.5	50mA, 5mA	MPS6512
	MPS6517	40	90-180	2mA, 10	0.5	50mA, 5mA	MPS6513
	MPS6518	40	150-300	2mA, 10	0.5	50mA, 5mA	MPS6514
MPS6530		40	40-120	100mA, 1	0.5	100mA, 10mA	MPS6533
MPS6531		40	90-270	100mA, 1	0.3	100mA, 10mA	MPS6534
MPS6532		30	30-	100mA, 1	0.5	100mA, 10mA	MPS6535
	MPS6533	40	40-120	100mA, 1	0.5	100mA, 10mA	MPS6530
	MPS6534	40	90-270	100mA, 1	0.3	100mA, 10mA	MPS6531
	MPS6535	30	30-	100mA, 1	0.5	100mA, 10mA	MPS6532
MPS5172		25	100-500	10mA, 10	0.25	10mA, 1mA	MPS6076
	MPS6076	25	100-500	10mA, 10	0.25	10mA, 1mA	MPS5172
D38H1-3		60	60-500	10mA, 1	0.125	100mA, 10mA	D39J1-3
	D39J1-3	60	60-500	10mA, 1	0.260	100mA, 10mA	D38H1-3
D38H4-6		80	60-500	10mA, 1	0.125	100mA, 10mA	D39J4-6
	D39J4-6	80	60-500	10mA, 1	0.260	100mA, 10mA	D38H4-6
D38L1-3		40	2K-70K	2mA, 5	1.5	500mA, .5mA	D39C1-3
	D39C1-3	40	2K-70K	2mA, 5	1.75	500mA, .5mA	D38L1-3
D38L4-6		25	2K-70K	2mA, 5	1.5	500mA, .5mA	D39C4-6
	D39C4-6	25	2K-70K	2mA, 5	1.75	500mA, .5mA	D38L4-6

**SILICON SIGNAL
LOW NOISE AMPLIFIERS
TO-92 PACKAGE**

TRANSISTORS AU SILICIUM
AMPLIFICATEURS FAIBLE BRUIT
BOITER TO-92

SILIZIUM-SIGNAL-TRANSISTOREN
RAUSCHARME VERSTÄRKER
TO-92 GEHÄUSE

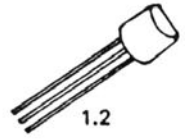

Device	Type	BV _{CEO} (V)	h _{FE}		NF (db)	Conditions
			Min.-Max.	@ I _C , V _{CE} (V)		
GES5827A	NPN	40	250-500	2mA, 5	5	V _{CE} = 5V, I _C = 100μA, R _g = 5K, BW = 15.7KHz
GES5828A	NPN	40	400-800	2mA, 5	5	V _{CE} = 5V, I _C = 100μA, R _q = 5K, BW = 15.7KHz
GES6000	NPN	25	100-300	10mA, 1	3	V _{CE} = 5V, I _E = 100μA, R _s = 5K, BW = 15.7KHz
GES6001	PNP	25	100-300	10mA, 1	3	V _{CE} = 5V, I _E = 100μA, R _s = 5K, BW = 15.7KHz
GES6004	NPN	40	100-300	10mA, 1	3	V _{CE} = 5V, I _E = 100μA, R _s = 5K, BW = 15.7KHz
GES6005	PNP	40	100-300	10mA, 1	3	V _{CE} = 5V, I _E = 100μA, R _s = 5K, BW = 15.7KHz
GES6010	NPN	40	100-300	10mA, 1	5	V _{CE} = 5V, I _E = 100μA, R _s = 5K, BW = 15.7KHz
GES6011	PNP	40	100-300	10mA, 1	3	V _{CE} = 5V, I _E = 100μA, R _s = 5K, BW = 15.7KHz
GES6014	NPN	60	100-300	10mA, 1	5	V _{CE} = 5V, I _E = 100μA, R _s = 5K, BW = 15.7KHz
GES6015	PNP	60	100-300	10mA, 1	3	V _{CE} = 5V, I _E = 100μA, R _s = 5K, BW = 15.7KHz
GES929	NPN	50	60-120	10 μA, 5	4	V _{CE} = 5V, I _C = 10μA, R _s = 10K, BW = 15.7KHz, f = 10Hz to 10KHz
GES930	NPN	50	100-300	10 μA, 5	3	V _{CE} = 5V, I _C = 10μA, R _s = 10K, BW = 15.7KHz, f = 10Hz to 10KHz
GES5306A	NPN	25	7K-70K	2mA, 5	5	V _{CE} = 5V, I _C = 600μA, R _g = 160K, BW = 15.7KHz, f = 10Hz to 10KHz
GES5308A	NPN	10	7K-70K	2mA, 5	5	V _{CE} = 5V, I _C = 600μA, R _g = 160K, BW = 15.7KHz, f = 10Hz to 10KHz
D38S1-4	NPN	30	400-3K	100 μA, 5	Typ 1.3	V _{CE} = 5V, I _C = 100μA, R _g = 100K, F = 1KHz
D38S7	NPN	45	400-2K	100 μA, 5	Typ 1.3	V _{CE} = 5V, I _C = 100μA, R _g = 100K, F = 1KHz
D38S8-10	NPN	60	250-1.2K	100 μA, 5	Typ 1.3	V _{CE} = 5V, I _C = 100μA, R _g = 100K, F = 1KHz
D38W8-10	NPN	80	150-1.2K	100 μA, 5	2	V _{CE} = 5V, I _C = 100μA, R _g = 10K, BW = 15.7KHz, f = 10Hz to 10KHz
D38W13-14	NPN	100	150-800	100 μA, 5	2	V _{CE} = 5V, I _C = 100μA, R _g = 10K, BW = 15.7KHz, f = 10Hz to 10KHz
GES6012	NPN	40	200-500	10mA, 1	3	V _{CE} = 5V, I _E = 100μA, R _s = 5K, BW = 15.7KHz
GES6013	PNP	40	200-500	10mA, 1	2	V _{CE} = 5V, I _E = 100μA, R _s = 5K, BW = 15.7KHz
GES6016	NPN	60	200-500	10mA, 1	3	V _{CE} = 5V, I _E = 100μA, R _s = 5K, BW = 15.7KHz
GES6017	PNP	60	200-500	10mA, 1	2	V _{CE} = 5V, I _E = 100μA, R _s = 5K, BW = 15.7KHz

**SILICON SIGNAL TRANSISTORS
SWITCHES
TO-92 PACKAGE**
TRANSISTORS DE COMMUTATION
AU SILICIUM
BOITIER TO-92
**SILIZIUM-SIGNAL-TRANSISTOREN
FÜR SCHALTANWENDUNGEN
TO-92 GEHÄUSE**

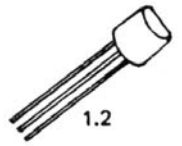

Device	Type	BV_{CEO}	T_{ON} (n sec.)	T_{OFF} (n sec.)	I_C (mA)	I_B (mA)	I_{B2} (T_{OFF}) (mA)	V_{CE} (V)	$V_{EB(OFF)}$ (T_{ON}) (V)
2N3903	NPN	40	70	225	10	1	1	3	0.5
2N3904	NPN	40	70	250	10	1	1	3	0.5
2N3905	PNP	40	70	260	10	1	1	3	0.5
2N3906	PNP	40	70	300	10	1	1	3	0.5
2N4400	NPN	40	35	255	150	15	15	30	2.0
2N4401	NPN	40	35	255	150	15	15	30	2.0
2N4402	PNP	40	35	255	150	15	15	30	2.0
2N4403	PNP	40	35	255	150	15	15	30	2.0
GES5368	NPN	30	40	350	150	15	15	30	—
GES5369	NPN	30	40	350	150	15	15	30	—
GES5370	NPN	30	40	400	150	15	15	30	—
GES5371	NPN	30	40	400	150	15	15	30	—
GES5372	PNP	30	50	150	150	15	15	30	—
GES5373	PNP	30	50	150	150	15	15	30	—
GES5374	PNP	30	50	175	150	15	15	30	—
GES5375	PNP	30	50	175	150	15	15	30	—
GES6000	NPN	25	20	205	150	15	15	30	—
GES6002	NPN	25	20	250	150	15	15	30	—
GES6004	NPN	40	20	180	150	15	15	30	—
GES6006	NPN	40	20	240	150	15	15	30	—
GES6001	PNP	25	20	155	150	15	15	30	—
GES6003	PNP	25	20	200	150	15	15	30	—
GES6005	PNP	40	20	155	150	15	15	30	—
GES6007	PNP	40	20	200	150	15	15	30	—
GES6010	NPN	40	40	400	150	15	15	30	—
GES6012	NPN	40	40	500	150	15	15	30	—
GES6014	NPN	60	40	400	150	15	15	30	—
GES6016	NPN	60	40	500	150	15	15	30	—
GES6011	PNP	40	40	425	150	15	15	30	—
GES6013	PNP	40	40	525	150	15	15	30	—
GES6015	PNP	60	40	425	150	15	15	30	—
GES6017	PNP	60	40	525	150	15	15	30	—
GES2221A	NPN	40	35	285	150	15	15	30	—
GES2222A	NPN	40	35	285	150	15	15	30	—
GES2906	PNP	40	50	110	150	15	15	30	—
GES2907	PNP	40	50	110	150	15	15	30	—
MPS3638	PNP	25	75	170	300	30	30	10	3.1
MPS3638A	PNP	25	75	170	300	30	30	10	3.1

**SILICON SIGNAL
DARLINGTON TRANSISTORS**
TRANSISTORS DARLINGTON
AU SILICIUM
**SILIZIUM-SIGNAL-TRANSISTOREN
IN DARLINGTONSCHALTUNG**

TO-92 PACKAGE

Device	Type	BV _{CEO} (V)	Min.-Max.	h _{FE}		V _{CE(SAT)}	
				@ I _C , V _{CE} (V)	(V) Max. @	I _C , I _B	
GES5305	NPN	25	2K-20K	2mA, 5	1.4	200mA, 200μA	
GES5306	NPN	25	7K-70K	2mA, 5	1.4	200mA, 200μA	
GES5306A	NPN	25	7K-70K	2mA, 5	1.4	200mA, 200μA	
GES5307	NPN	40	2K-20K	2mA, 5	1.4	200mA, 200μA	
GES5308	NPN	40	7K-70K	2mA, 5	1.4	200mA, 200μA	
GES5308A	NPN	40	7K-70K	2mA, 5	1.4	200mA, 200μA	
D38L1-3	NPN	40	2K-70K	2mA, 5	1.5	500mA, 500μA	
D39C1-3	PNP	40	2K-70K	2mA, 5	1.75	500mA, 500μA	
D39C4-6	PNP	25	2K-70K	2mA, 5	1.75	500mA, 500μA	

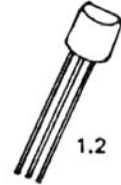

TO-98 PACKAGE

Device	Type	BV _{CEO} (V)	Min.-Max.	h _{FE}		V _{CE(SAT)}	
				@ I _C , V _{CE} (V)	(V) Max. @	I _C , I _B	
2N5305	NPN	25	2K-20K	2mA, 5	1.4	200mA, 200μA	
2N5306	NPN	25	7K-70K	2mA, 5	1.4	200mA, 200μA	
2N5306A	NPN	25	7K-70K	2mA, 5	1.4	200mA, 200μA	
2N5307	NPN	40	2K-20K	2mA, 5	1.4	200mA, 200μA	
2N5308	NPN	40	7K-70K	2mA, 5	1.4	200mA, 200μA	
2N5308A	NPN	40	7K-70K	2mA, 5	1.4	200mA, 200μA	
D16P1	NPN	12	2K-70K	2mA, 5	1.4	200mA, 200μA	



**SILICON SIGNAL
HIGH VOLTAGE TYPES**
TRANSISTORS AU SILICIUM
HAUTE TENSION
**SILIZIUM-SIGNAL-TRANSISTOREN
FÜR HÖHERE SPANNUNGEN**

TO-92 PACKAGE

Device	BV _{CEO} (V)	Min.-Max.	h _{FE}		I _{CBO}		V _{CE(SAT)}	
			@ I _C , V _{CE} (V)	(V) Max. @	I _C , I _B			
GES6218	300	20	20mA, 10	500nA	250	1.0	10mA, 1mA	
GES6219	250	20	20mA, 10	1μA	200	1.0	10mA, 1mA	
GES6220	200	20	20mA, 10	1μA	150	2.0	20mA, 2mA	
GES6221	150	20	20mA, 10	10μA	100	2.3	20mA, 2mA	

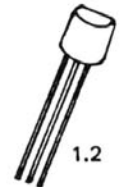

TO-98 PACKAGE

Device	BV _{CEO} (V)	Min.-Max.	h _{FE}		I _{CBO}		V _{CE(SAT)}	
			@ I _C , V _{CE} (V)	(V) Max. @	I _C , I _B			
2N3877	70	20	2mA, 5	100nA*	40	.125	10mA, 1mA	
2N3877A	85	20	2mA, 5	100nA*	40	.125	10mA, 1mA	
2N5174	75	40-600	10mA, 5	500nA	60	.950	10mA, 1mA	
2N5175	100	55-160	10mA, 5	500nA	60	.950	10mA, 1mA	
2N5176	100	140-300	10mA, 5	500nA	60	.950	10mA, 1mA	



**PROELECTRON SILICON SIGNAL TRANSISTORS
TO-92 PACKAGE**

TRANSISTORS DE SIGNAL AU SILICIUM – TYPE PROELECTRON
BOITIER TO-92

PROELECTRON SILIZIUM-SIGNAL-TRANSISTOREN
TO-92 GEHÄUSE

Device	Type	BV _{CEO} (V)	I _C (mA)	h _{FE}		V _{CE(SAT)}	
				Min. - Max.	@ I _C , V _{CE} (V)	(V) Max.	@ I _C , I _B
BC170	NPN	20	100	36 -600	1mA, 1	0.4	30mA, 3.0mA
BC171	NPN	45	100	230 -typ.	2mA, 5	0.6	100mA, 5.0mA
BC237	NPN	45	100	125*-	2mA, 5	0.25	10mA, 0.5mA
BC237A	NPN	45	100	110 -220	2mA, 5	0.25	10mA, 0.5mA
BC237B	NPN	45	100	200 -450	2mA, 5	0.25	10mA, 0.5mA
BC307	PNP	45	100	75*-	2mA, 5	0.3	10mA, 0.5mA
BC307A	PNP	45	100	125*-	2mA, 5	0.6	100mA, 5.0mA
BC308	PNP	25	100	75*-	2mA, 5	0.3	10mA, 0.5mA
BC308A	PNP	25	100	125*-	2mA, 5	0.3	10mA, 0.3mA
BC309	PNP	20	100	70 -460	2mA, 5	0.3	10mA, 0.5mA
BC309A	PNP	20	100	125*-	2mA, 5	0.3	10mA, 0.5mA
BC327A (16)	PNP	45	500	100 -250	100mA, 1	0.7	500mA, 50 mA
BC327 (25)	PNP	45	800	160 -400	100mA, 1	0.7	500mA, 50 mA
BC337 (16)	NPN	45	500	100 -250	100mA, 1	0.7	500mA, 50 mA
BC337 (25)	NPN	45	800	160 -400	100mA, 1	0.7	500mA, 50 mA
BC182A	NPN	50	200	125*-	2mA, 5	0.6	100mA, 5.0mA
BC212	PNP	50	200	60 -300	2mA, 5	0.6	100mA, 5.0mA
BC212A	PNP	50	200	100*-	2mA, 5	0.6	100mA, 5.0mA
BC238	NPN	20	100	125*	2mA, 5	0.25	10mA, 0.5mA
BC238A	NPN	20	100	110 -220	2mA, 5	0.25	10mA, 0.5mA
BC238B	NPN	20	100	200 -450	2mA, 5	0.25	10mA, 0.5mA
BC328C	NPN	20	100	420 -800	2mA, 5	0.25	10mA, 0.5mA
BC239	NPN	20	100	240*-	2mA, 5	0.25	10mA, 0.5mA
BC239B	NPN	20	100	200 -450	2mA, 5	0.25	10mA, 0.5mA
BC239C	NPN	20	100	420 -800	2mA, 5	0.25	10mA, 0.5mA
BC547	NPN	45	100	125*-	2mA, 5	0.6	100mA, 5.0mA
BC547B	NPN	45	100	200 -450	2mA, 5	0.6	100mA, 5.0mA
BC547C	NPN	45	100	420 -800	2mA, 5	0.77	10mA, 5.0mA
BC548	NPN	20	100	125*-	2mA, 5	0.6	100mA, 5.0mA
BC548B	NPN	20	100	200 -450	2mA, 5	0.6	100mA, 5.0mA
BC548C	NPN	20	100	420 -800	2mA, 5	0.6	100mA, 5.0mA
BC549	NPN	20	100	240*-	2mA, 5	0.6	100mA, 5.0mA
BC549B	NPN	20	100	200 -450	2mA, 5	0.6	100mA, 5.0mA
BC549C	NPN	20	100	420 -800	2mA, 5	0.6	100mA, 5.0mA

*h_{fe} – Dynamic Forward Current Transfer Ratio

SILICON POWER DARLINGTON TRANSISTORS
 TRANSISTORS DARLINGTON DE PUISSANCE AU SILICIUM
 SILIZIUM-LEISTUNGSTRANSISTOREN IN DARLINGTONSCHALTUNG,

NPN HIGH GAIN
NPN GRAND GAIN
NPN, MIT HÖHERER STROMVERSTÄRKUNG

GE Type	P_T $T_C = 25^\circ\text{C}$ Max. (W)	V_{CE0} Min. (V)	I_C Cont. (A)	h_{FE} @ 5V, 200 mA		f_t Typical (MHz)	Package Type	Package Outline No.
				Min.	Max.			
D40C1	6.25	30	.5	10,000	60,000	75	BROWN Power Tab	198
D40C2	6.25	30	.5	40,000	—	75	BROWN Power Tab	198
D40C3	6.25	30	.5	90,000	—	75	BROWN Power Tab	198
D40C4	6.25	30	.5	10,000	60,000	75	BROWN Power Tab	198
D40C5	6.25	30	.5	40,000	—	75	BROWN Power Tab	198
D40C7	6.25	30	.5	10,000	60,000	75	BROWN Power Tab	198
D40C8	6.25	30	.5	40,000	—	75	BROWN Power Tab	198

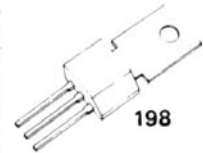

COMPLEMENTARY – 2 AMPERES
 COMPLEMENTAIRES 2A
 2A – KOMPLEMENTÄRTYPEN

GE Type	NPN	PNP	P_T $T_C = 25^\circ\text{C}$ Min. (W)	V_{CE0} Min. (V)	I_C Cont. (A)	h_{FE} @ 5V, 200 mA		f_t Typical (MHz)	Package Type	Package Outline No.
						Min.	Max.			
D40K1	—	—	10	30	2	10,000	—	75	BROWN Power Tab	198
—	D41K1	—	10	-30	-2	10,000	—	75	BLACK Power Tab	198
D40K2	—	—	10	50	2	10,000	—	75	BLACK Power Tab	198
—	D41K2	—	10	-50	-2	10,000	—	75	BLACK Power Tab	198
—	D41K3	—	10	-30	-2	10,000	—	75	BLACK Power Tab	198
—	D41K4	—	10	-50	-2	10,000	—	75	BLACK Power Tab	198

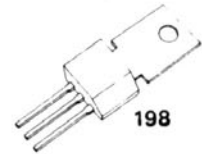

COMPLEMENTARY – 4 AMPERES
 COMPLEMENTAIRES 4A
 4A – KOMPLEMENTÄRTYPEN

GE Type	NPN	PNP	P_T $T_C = 25^\circ\text{C}$ Max. (W)	V_{CE0} Min. (V)	I_C Cont. (A)	h_{FE} @ 2V, 1A		Package Type	Package Outline No.
						Min.	Max.		
D42D1	—	—	12.5	40	4.0	5,000	—	RED Power Tab	198A
—	D43D1	—	12.5	-40	-4.0	5,000	—	GREEN Power Tab	198A
D42D2	—	—	12.5	40	4.0	5,000	—	RED Power Tab	198A
—	D43D2	—	12.5	-40	-4.0	5,000	—	GREEN Power Tab	198A
D42D3	—	—	12.5	60	4.0	5,000	—	RED Power Tab	198A
—	D43D3	—	12.5	-60	-4.0	5,000	—	GREEN Power Tab	198A
D42D4	—	—	12.5	60	4.0	5,000	—	RED Power Tab	198A
—	D43D4	—	12.5	-60	-4.0	5,000	—	GREEN Power Tab	198A
D42D5	—	—	12.5	80	4.0	5,000	—	RED Power Tab	198A
—	D43D5	—	12.5	-80	-4.0	5,000	—	GREEN Power Tab	198A
D42D6	—	—	12.5	80	4.0	5,000	—	RED Power Tab	198A
—	D43D6	—	12.5	-80	-4.0	5,000	—	GREEN Power Tab	198A

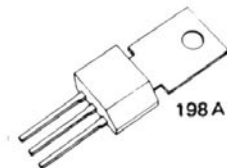

COMPLEMENTARY – 6 AMPERES
COMPLEMENTAIRES 6A
6A – KOMPLEMENTÄRTYPEN

GE Type		P_T Max. (W)	V_{CE0} Min. (V)	I_C Cont. (A)	h_{FE} @ 2V, 1A		Package Type	Package Outline No.
NPN	PNP				Min.	Max.		
D44D1	–	30.0	40	6.0	5,000	–	RED Power Tab	229
–	D45D1	30.0	–40	–6.0	5,000	–	GREEN Power Tab	229
D44D2	–	30.0	40	6.0	5,000	–	RED Power Tab	229
–	D45D2	30.0	–40	–6.0	5,000	–	GREEN Power Tab	229
D44D3	–	30.0	60	6.0	5,000	–	RED Power Tab	229
–	D45D3	30.0	–60	–6.0	5,000	–	GREEN Power Tab	229
D44D4	–	30.0	60	6.0	5,000	–	RED Power Tab	229
–	D45D4	30.0	–60	–6.0	5,000	–	GREEN Power Tab	229
D44D5	–	30.0	80	6.0	5,000	–	RED Power Tab	229
–	D45D5	30.0	–80	–6.0	5,000	–	GREEN Power Tab	229
D44D6	–	30.0	80	6.0	5,000	–	RED Power Tab	229
–	D45D6	30.0	–80	–6.0	5,000	–	GREEN Power Tab	229

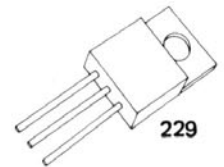

COMPLEMENTARY – 10 AMPERES
COMPLEMENTAIRES 10A
10A – KOMPLEMENTÄRTYPEN

GE Type		P_T Max. (W)	V_{CE0} Min. (V)	I_C Cont. (A)	h_{FE} @ 5V, 5A		Package Type	Package Outline No.
NPN	PNP				Min.	Max.		
D44E1	–	50	40	10	1,000	–	RED Power Pac	229
–	D45E1	50	–40	–10	1,000	–	GREEN Power Pac	229
D44E2	–	50	60	10	1,000	–	RED Power Pac	229
–	D45E2	50	–60	–10	1,000	–	GREEN Power Pac	229
D44E3	–	50	80	10	1,000	–	RED Power Pac	229
–	D45E3	50	–80	–10	1,000	–	GREEN Power Pac	229

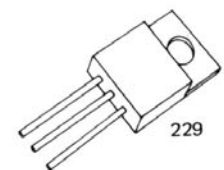

SILICON POWER TRANSISTORS NPN HIGH VOLTAGE

TRANSISTORS NPN DE PUISSANCE AU SILICIUM
HAUTE TENSION

SILIZIUM-NPN-LEISTUNGS-TRANSISTOREN
FÜR HÖHERE SPANNUNGEN

GE Type	P_T $T_C = 25^\circ\text{C}$ Max. (W)	V_{CE0} Min. (V)	I_C Cont. (A)	h_{FE} @ 10V, 20 mA		h_{FE} @ 10V, 500 mA		f_t Typical (MHz)	Package Type	Package Outline No.
				Min.	Max.	Min.	Max.			
D40V1	9.0	250	0.1	30	90	—	—	80	BROWN Power Tab	198
D40V2	9.0	250	0.1	60	180	—	—	80	BROWN Power Tab	198
D40V3	9.0	300	0.1	30	90	—	—	80	BROWN Power Tab	198
D40V4	9.0	300	0.1	60	180	—	—	80	BROWN Power Tab	198
D40V5	9.0	350	0.1	30	90	—	—	80	BROWN Power Tab	198
D40V6	9.0	350	0.1	60	180	—	—	80	BROWN Power Tab	198
D40P1	6.2	120	0.5	40 ¹	—	20 ²	—	—	BROWN Power Tab	198
D40P3	6.2	180	0.5	40 ¹	—	20 ²	—	—	BROWN Power Tab	198
D40P5	6.2	225	0.5	40 ¹	—	20 ²	—	—	BROWN Power Tab	198
D42T1	15.0	250	2.0	—	—	30	90	45	RED Power Tab	198A
D42T2	15.0	250	2.0	—	—	75	175	45	RED Power Tab	198A
D42T3	15.0	300	2.0	—	—	30	90	45	RED Power Tab	198A
D42T4	15.0	300	2.0	—	—	75	175	45	RED Power Tab	198A
D42T5	15.0	250	2.0	—	—	30	—	45	RED Power Tab	198A
D42T6	15.0	300	2.0	—	—	30	—	45	RED Power Tab	198A
D42T7	15.0	250	2.0	—	—	150	300	45	RED Power Tab	198A
D42T8	15.0	300	2.0	—	—	150	300	45	RED Power Tab	198A
D44Q1	31.2	125	4.0	30 ³	—	20 ⁴	—	50	RED Power Pac	229
D44Q3	31.2	175	4.0	30 ³	—	20 ⁴	—	50	RED Power Pac	229
D44Q5	31.2	225	4.0	30 ³	—	20 ⁴	—	50	RED Power Pac	229
D44T1	31.2	250	2.0	—	—	30	90	45	RED Power Pac	229
D44T2	31.2	250	2.0	—	—	75	175	45	RED Power Pac	229
D44T3	31.2	300	2.0	—	—	30	90	45	RED Power Pac	229
D44T4	31.2	300	2.0	—	—	75	175	45	RED Power Pac	229
D44T5	31.2	250	2.0	—	—	30	—	45	RED Power Pac	229
D44T6	31.2	300	2.0	—	—	30	—	45	RED Power Pac	229
D44T7	31.2	250	2.0	—	—	150	300	45	RED Power Pac	229
D44T8	31.2	300	2.0	—	—	150	300	45	RED Power Pac	229

¹ Measured at 80mA

² Measured at 2mA

³ Measured at 200mA

⁴ Measured at 2A

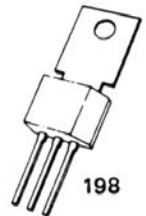

198

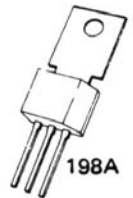

198A

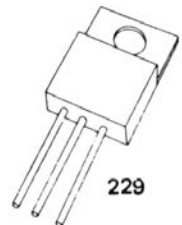

229

**SILICON POWER TRANSISTORS
COMPLEMENTARY – 1 AMPERE**
TRANSISTORS DE PUISSANCE AU SILICIUM
COMPLEMENTAIRES – 1 AMPERE
SILIZIUM – LEISTUNGSTRANSISTOREN
1A – KOMPLEMENTÄRTYPEN

GE Type NPN	Type PNP	P _t T _C = 25°C Max. (W)	V _{CEO} Min. (V)	I _C Cont. (A)	h _{FE} @ 2V, 100mA		h _{FE} @ 2V, 1A	Package Type	Package Outline No.
					Min.	Max.	Min.		
D40D1	—	6.25	30	1.0	50	150	10	BROWN Power Tab	198
—	D41D1	6.25	-30	-1.0	50	150	10	BLACK Power Tab	198
D40D2	—	6.25	30	1.0	120	360	20	BROWN Power Tab	198
—	D41D2	6.25	-30	-1.0	120	360	20	BLACK Power Tab	198
D40D3	—	6.25	30	1.0	290	—	10	BROWN Power Tab	198
D40D4	—	6.25	45	1.0	50	150	10	BROWN Power Tab	198
—	D41D4	6.25	-45	-1.0	50	150	10	BLACK Power Tab	198
D40D5	—	6.25	45	1.0	120	360	10	BROWN Power Tab	198
—	D41D5	6.25	-45	-1.0	120	360	10	BLACK Power Tab	198
D40D7	—	6.25	60	1.0	50	150	10	BROWN Power Tab	198
—	D41D7	6.25	-60	-1.0	50	150	10	BLACK Power Tab	198
D40D8	—	6.25	60	1.0	120	360	10	BROWN Power Tab	198
—	D41D8	6.25	-60	-1.0	120	360	10	BLACK Power Tab	198
D40D10	—	6.25	75	1.0	50	150	10	BROWN Power Tab	198
—	D41D10	6.25	-75	-1.0	50	150	10	BLACK Power Tab	198
D40D11	—	6.25	75	1.0	120	360	10	BROWN Power Tab	198
—	D41D11	6.25	-75	-1.0	120	360	10	BLACK Power Tab	198
D40D13	—	6.25	75	1.0	50	150	—	BROWN Power Tab	198
—	D41D13	6.25	-75	-1.0	50	150	—	BLACK Power Tab	198
D40D14	—	6.25	75	1.0	120	360	—	BROWN Power Tab	198
—	D41D14	6.25	-75	-1.0	120	360	—	BLACK Power Tab	198

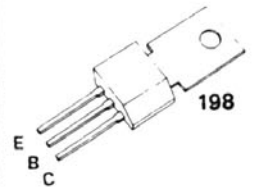

**SILICON POWER TRANSISTORS
COMPLEMENTARY – 2 AMPERES**
TRANSISTORS DE PUISSANCE AU SILICIUM
COMPLEMENTAIRES – 2 AMPERES
SILIZIUM – LEISTUNGSTRANSISTOREN
2A – KOMPLEMENTÄRTYPEN

GE Type NPN	Type PNP	P _t T _C = 25°C Max. (W)	V _{CEO} Min. (V)	I _C Cont. (A)	h _{FE} @ 2V, 100Ma		h _{FE} @ 2V, 1A	Package Type	Outline No.
					Min.	Max.	Min.		
D40E1	—	8	30	2	50	—	10	BROWN Power Tab	198
—	D41E1	8	-30	2	50	—	10	BLACK Power Tab	198
D40E5	—	8	60	2	50	—	10	BROWN Power Tab	198
—	D41E5	8	-60	2	50	—	10	BLACK Power Tab	198
D40E7	—	8	80	2	50	—	10	BROWN Power Tab	198
—	D41E7	8	-80	2	50	—	10	BLACK Power Tab	198

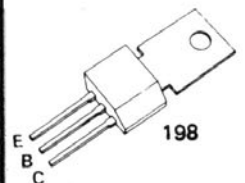

**SILICON POWER TRANSISTORS
COMPLEMENTARY – 3 AMPERES**

TRANSISTORS DE PUISSANCE AU SILICIUM
COMPLEMENTAIRES – 3 AMPERES

SILIZIUM – LEISTUNGSTRANSISTOREN
3A – KOMPLEMENTÄRTYPEN

GE Type	NPN	PNP	P_T $T_C = 25^\circ\text{C}$ Max. (W)	V_{CE0} Min. (V)	I_C Cont. (A)	h_{FE} @ 1V, 200mA		h_{FE} @ 1V, 1A Min.	Package Type	Package Outline No.
						Min.	Max.			
D42C1	–		12.5	30	3.0	25	–	10	RED Power Tab	198A
–	D43C1		12.5	–30	–3.0	25	–	10	GREEN Power Tab	198A
D42C2	–		12.5	30	3.0	40	120	20	RED Power Tab	198A
–	D43C2		12.5	–30	–3.0	40	120	20	GREEN Power Tab	198A
D42C3	–		12.5	30	3.0	40	120	20 ¹	RED Power Tab	198A
–	D43C3		12.5	–30	–3.0	40	120	20 ¹	GREEN Power Tab	198A
D42C4	–		12.5	45	3.0	25	–	10	RED Power Tab	198A
–	D43C4		12.5	–45	–3.0	25	–	10	GREEN Power Tab	198A
D42C5	–		12.5	45	3.0	40	120	20	RED Power Tab	198A
–	D43C5		12.5	–45	–3.0	40	120	20	GREEN Power Tab	198A
D42C6	–		12.5	45	3.0	40	120	20 ¹	RED Power Tab	198A
–	D43C6		12.5	–45	–3.0	40	120	20 ¹	GREEN Power Tab	198A
D42C7	–		12.5	60	3.0	25	–	10	RED Power Tab	198A
–	D43C7		12.5	–60	–3.0	25	–	10	GREEN Power Tab	198A
D42C8	–		12.5	60	3.0	40	120	20	RED Power Tab	198A
–	D43C8		12.5	–60	–3.0	40	120	20	GREEN Power Tab	198A
D42C9	–		12.5	60	3.0	40	120	20 ¹	RED Power Tab	198A
–	D43C9		12.5	–60	–3.0	40	120	20 ¹	GREEN Power Tab	198A
D42C10	–		12.5	80	3.0	25	–	10	RED Power Tab	198A
–	D43C10		12.5	–80	–3.0	25	–	10	GREEN Power Tab	198A
D42C11	–		12.5	80	3.0	40	120	20	RED Power Tab	198A
–	D43C11		12.5	–80	–3.0	40	120	20	GREEN Power Tab	198A
D42C12	–		12.5	80	3.0	40	120	20 ¹	RED Power Tab	198A
–	D43C12		12.5	–80	–3.0	40	120	20 ¹	GREEN Power Tab	198A

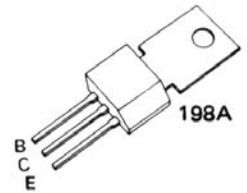

¹ h_{FE} measured at $I_C = 2A$.

**SILICON POWER TRANSISTORS
COMPLEMENTARY – 4 AMPERES**

TRANSISTORS DE PUISSANCE AU SILICIUM
COMPLEMENTAIRES – 3 AMPERES

SILIZIUM – LEISTUNGSTRANSISTOREN
4A – KOMPLEMENTÄRTYPEN

GE Type NPN	PNP	P _T T _C = 25°C Max. (W)	V _{CEO} Min. (V)	I _C Cont. (A)	h _{FE} @ 1V, 200mA		h _{FE} @ 1V, 1A	Package Type	Package Outline No.
					Min.	Max.	Min.		
D44C1	–	30.0	30	4.0	25	–	10	RED Power Pac	229
–	D45C1	30.0	–30	–4.0	25	–	10	GREEN Power Pac	229
D44C2	–	30.0	30	4.0	40	120	20	RED Power Pac	229
–	D45C2	30.0	–30	–4.0	40	120	20	GREEN Power Pac	229
D44C3	–	30.0	30	4.0	40	120	20 ¹	RED Power Pac	229
–	D45C3	30.0	–30	–4.0	40	120	20 ¹	GREEN Power Pac	229
D44C4	–	30.0	45	4.0	25	–	10	RED Power Pac	229
–	D45C4	30.0	–45	–4.0	25	–	10	GREEN Power Pac	229
D44C5	–	30.0	45	4.0	40	120	20	RED Power Pac	229
–	D45C5	30.0	–45	–4.0	40	120	20	GREEN Power Pac	229
D44C6	–	30.0	45	4.0	40	120	20 ¹	RED Power Pac	229
–	D45C6	30.0	–45	–4.0	40	120	20 ¹	GREEN Power Pac	229
D44C7	–	30.0	60	4.0	25	–	10	RED Power Pac	229
–	D45C7	30.0	–60	–4.0	25	–	10	GREEN Power Pac	229
D44C8	–	30.0	60	4.0	40	120	20	RED Power Pac	229
–	D45C8	30.0	–60	–4.0	40	120	20	GREEN Power Pac	229
D44C9	–	30	60	4.0	40	120	20 ¹	RED Power Pac	229
–	D45C9	30	–60	–4.0	40	120	20 ¹	GREEN Power Pac	229
D44C10	–	30	80	4.0	25	–	10	RED Power Pac	229
–	D45C10	30	–80	–4.0	25	–	10	GREEN Power Pac	229
D44C11	–	30	80	4.0	40	120	20	RED Power Pac	229
–	D45C11	30	–80	–4.0	40	120	20	GREEN Power Pac	229
D44C12	–	30	80	4.0	40	120	20 ¹	RED Power Pac	229
–	D45C12	30	–80	–4.0	40	120	20 ¹	GREEN Power Pac	229

¹ h_{FE} measured at I_C = 2A

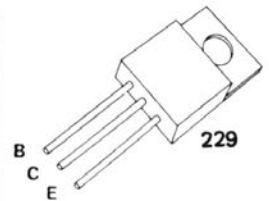

**SILICON POWER TRANSISTORS
COMPLEMENTARY – 10 AMPERES**

TRANSISTORS DE PUISSANCE AU SILICIUM
COMPLEMENTAIRES – 10 AMPERES

SILIZIUM – LEISTUNGSTRANSISTOREN
10A – KOMPLEMENTÄRTYPEN

GE Type	NPN	PNP	P_T $T_C = 25^\circ\text{C}$ Max. (W)	V_{CE0} Min. (V)	I_C Cont. (A)	h_{FE} h_{FE}		Package Type	Package Outline No.
						@1V, 2A Min.	@1V, 4A Min.		
D44H1	–		50	30	10	35	20	RED Power Pac	229
–	D45H1		50	–30	–10	35	20	GREEN Power Pac	229
D44H2	–		50	30	10	60	40	RED Power Pac	229
–	D45H2		50	–30	–10	60	40	GREEN Power Pac	229
D44H4	–		50	45	10	35	20	RED Power Pac	229
–	D45H4		50	–45	–10	35	20	GREEN Power Pac	229
D44H5	–		50	45	10	60	40	RED Power Pac	229
–	D45H5		50	–45	–10	60	40	GREEN Power Pac	229
D44H7	–		50	60	10	35	20	RED Power Pac	229
–	D45H7		50	–60	–10	35	20	GREEN Power Pac	229
D44H8	–		50	60	10	60	40	RED Power Pac	229
–	D45H8		50	–60	–10	60	40	GREEN Power Pac	229
–	D45H9		50	–60	–10	60	40	GREEN Power Pac	229
D44H10	–		50	80	10	35	20	RED Power Pac	229
–	D45H10		50	–80	–10	35	20	GREEN Power Pac	229
D44H11	–		50	80	10	60	40	RED Power Pac	229
–	D45H11		50	–80	–10	60	40	GREEN Power Pac	229
–	D45H12		50	–80	–10	60	40	GREEN Power Pac	229

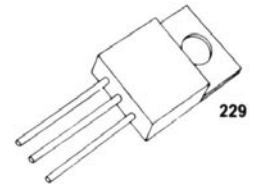

229

HIGH VOLTAGE POWER TRANSISTORS

TRANSISTORS DE PUISSANCE HAUTE TENSION
LEISTUNGSTRANSISTOREN FÜR HÖHERE SPANNUNGEN



TO-3

GE TYPE	V_{CE0} (SUS)	I_C PEAK (A)	h_{FE} @ I_C, V_{CE}	$V_{CE(SAT)}$ @ I_C, I_B	P_d (W)
			MIN.	MAX. (V)	
NPN FAST SWITCHING TRANSISTORS					
D64TS3 D64TS5	300 400	30	12 @ 5A, 2V 6 @ 10A, 2V	1.5 @ 10A, 2A 5.0 @ 15A, 3A	175
NPN DARLINGTONS					
GE5060 GE5061 GE5062	300 350 400	25	100 @ 10A, 5V 40 @ 15A, 5V 15 @ 20A, 5V	1.4 @ 10A, 2A 1.5 @ 10A, 1A 2.0 @ 20A, 2A	125
NPN FAST SWITCHING DARLINGTONS					
GE6060 GE6061 GE6062	300 350 400	25	100 @ 10A, 5V 40 @ 15A, 5V 15 @ 20A, 5V	1.4 @ 10A, 2A 1.5 @ 10A, 1A 2.0 @ 20A, 2A	125

PRO ELECTRON POWER TRANSISTORS
TRANSISTORS DE PUISSANCE – TYPE PROELECTRON
PROELECTRON LEISTUNGS-TRANSISTOREN

Device	Type	P _T (N)	V _{CEO}	I _C (A)	h _{FE}		V _{CE(SAT)}		f _T Typical MHz	Package
					Min. - Max.	@ I _C , V _{CE} (V)	Max.	@ I _C , I _B		
BD135G	NPN	12.5	45	2	40 -250	0.15A, 2	—	—	—	198A
BD136G	PNP	12.5	45	2	40 -250	0.15A, 2	—	—	—	198A
BD137G	NPN	12.5	60	2	40 -160	0.15A, 2	—	—	—	198A
BD138G	PNP	12.5	60	2	40 -160	0.15A, 2	—	—	—	198A
BD139G	NPN	12.5	80	2	40 -160	0.15A, 2	0.5	0.5A, 50mA	—	198A
BD140G	PNP	12.5	80	2	40 -160	0.15A, 2	0.5	0.5A, 50mA	—	198A
BD232G	NPN	15.0	300	1	25 -150	0.05A, 5	1.0	0.3A, 30mA	55	198A
BD233G	NPN	30.0	45	4	40 -250	0.15A, 2	0.5	1.0A, 100mA	50	229
BD234G	PNP	30.0	45	4	40 -250	0.15A, 2	0.5	1.0A, 100mA	40	229
BD235G	NPN	30.0	60	4	40 -250	0.15A, 2	0.5	1.0A, 100mA	50	229
BD236G	PNP	30.0	60	4	40 -250	0.15A, 2	0.5	1.0A, 100mA	40	229
BD237G	NPN	30.0	80	4	40 -250	0.15A, 2	0.5	1.0A, 100mA	50	229
BD238G	PNP	30.0	80	4	40 -250	0.15A, 2	0.5	1.0A, 100mA	40	229
BD279	NPN	10.0	40	2	10K-	0.2 A, 5	1.5	1.0A, 2.0mA	75	198A
BD280	PNP	10.0	40	2	10K-	0.2 A, 5	1.5	1.0A, 2.0mA	100	198A
BD401	NPN	50.0	45	10	35K-	2.0 A, 2	1.0	8.0A, 800mA	50	229
BD402	PNP	50.0	45	10	35K-	2.0 A, 2	1.0	8.0A, 800mA	40	229
BD403	NPN	50.0	60	10	35K-	2.0 A, 2	1.0	8.0A, 800mA	50	229
BD404	PNP	50.0	60	10	35K-	2.0 A, 2	1.0	8.0A, 800mA	40	229
BD566	PNP	50.0	60	3	1K-	5.0 A, 5	1.5	5.0A, 10mA	—	229
BD566A	PNP	50.0	80	3	1K-	5.0 A, 5	1.5	5.0A, 10mA	—	229
BD567	NPN	50.0	60	3	1K-	5.0 A, 5	1.5	5.0A, 10mA	—	229
BD567A	NPN	50.0	80	3	1K-	5.0 A, 5	1.5	5.0A, 10mA	—	229
BD833	NPN	12.5	45	3	40 -250	0.15A, 2	0.5	1.0A, 100mA	50	198A
BD834	PNP	12.5	45	3	40 -250	0.15A, 2	0.5	1.0A, 100mA	40	198A
BD835	NPN	12.5	60	3	40 -250	0.15A, 2	0.5	1.0A, 100mA	50	198A
BD836	PNP	12.5	60	3	40 -250	0.15A, 2	0.5	1.0A, 100mA	40	198A
BD837	NPN	12.5	80	3	40 -250	0.15A, 2	0.5	1.0A, 100mA	50	198A
BD838	PNP	12.5	80	3	40 -250	0.15A, 2	0.5	1.0A, 100mA	40	198A

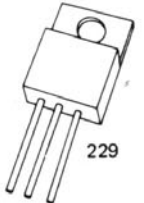
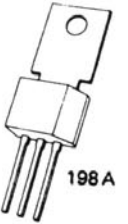

SILICON SIGNAL DIODES
DIODES SIGNAL AU SILICIUM
SILIZIUM-KLEIN-DIODEN

BV	BLOCKING VOLTAGE TENSION INVERSE MAX. MAX. SPERRSPANNUNG
I_R	REVERSE LEAKAGE CURRENT COURANT DE FUITE NEGATIVER LECKSTROM
V_R	REVERSE VOLTAGE TENSION INVERSE SPERRSPANNUNG
V_F	FORWARD VOLTAGE CHUTE DE TENSION DIRECTE DURCHLASS-SPANNUNG
t_{rr}	RECOVERY TIME TEMPS DE RECOUVREMENT SPERR-VERZUGSZEIT
C_O	CAPACITANCE CAPACITE KAPAZITÄT

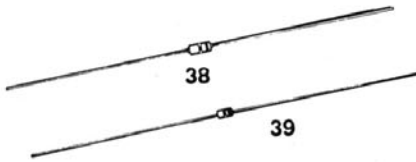

SILICON SIGNAL DIODES
DIODES DE SIGNAL AU SILICIUM
SILIZIUM-KLEIN-DIODEN

100 mA TYPES

Part Number	BV @ 100 μ A Min. (V)	I _R @ 25°C Max.		V _F Max.		C _O @ DV (pf)	t _{rr} (τ SEC)	Package Outline	Package Outline Number
		(nA)	@ V _R (V)	(V)	@ I _F (mA)				
1N914	100	25	30	1.00	10	4	4	D035	38
1N914A	100	25	20	1.00	20	4	4	D035	38
1N914B	100	25	20	1.00	100	4	4	D035	38
1N916	100	25	20	1.00	10	2	4	D035	38
1N916A	100	25	20	1.00	20	2	4	D035	38
1N916B	100	25	20	1.00	30	2	4	D035	38
1N4148*	100	25	20	1.00	10	4	4	D035	38
1N4149	100	25	20	1.00	10	2	4	D035	38
1N4151	75 ¹	50	50	1.00	50	2	2	D035	38
1N4152	40	50	30	.880	20	2	2	D035	38
1N4153*	75	50	50	.880	20	2	2	D035	38
1N4154	35	100	25	1.00	30	4	2	D035	38
1N4305	75	100	50	.850	10	2	2	D035	38
1N4444	70	50	50	1.00	100	2	7	D035	38
1N4446	100	25	20	1.00	20	4	4	D035	38
1N4447	100	25	20	1.00	20	2	4	D035	38
1N4448	100	25	20	1.00	100	4	4	D035	38
1N4449	100	25	20	1.00	30	2	4	D035	38
1N4454*	75	100	50	1.00	10	2	2	D035	38
1N4531*	100	25	20	1.00	10	4	4	D034	39
1N4532	75	100	50	1.00	10	2	2	D034	39
1N4533	40	50	30	.880	20	2	2	D034	39
1N4534	75	50	50	.880	20	2	2	D034	39
1N4536	35	100	25	1.00	30	4	2	D034	39
1N4727	30	100	20	.850	10	4	4	D035	38
1N4863	70	50	50	1.20	100	2	7	D035	38
DA1701	100	30	30	1.00	50	1	4	D035	38
DA1702	75	30	30	1.00	50	1	4	D035	38
DA1703	40	50	30	1.00	50	2	4	D035	38
DA1704	25	100	20	1.00	30	3	4	D035	38
MA1701	100	30	30	1.00	50	1	4	D034	39
MA1702	75	30	30	1.00	50	1	4	D034	39
MA1703	40	50	30	1.00	50	2	4	D034	39
MA1704	25	100	20	1.00	30	3	4	D034	39
DZ800	2	2000	2	.800	10	—	—	D035	38
DZ805	15	2000	12	.80	10	—	—	D035	38
DZ806	25	2000	22	.800	10	—	—	D035	38

¹ Measured at 5 μ A * JAN and JANTX types available

100-200 mA TYPES

Part Number	BV @ 100 μ A Min. (V)	I _R @ 25°C Max.		V _F Max.		C _O @ DV (pf)	t _r (nsec)	Package Type	Package Outline No.
		(nA)	@ V _R (V)	(V)	@ I _F (mA)				
1N4150 *	50	100	50	1.00	200	2.5	4	D035	38
1N4450	30	50	30	1.00	200	4	4	D035	38
1N4606	85	100	50	1.00	200	2.5	4	D035	38

* JAN and JANTX types available

200-400 mA TYPES

38

Part Number	BV @ 100 μ A Min. (V)	I _R @ 25°C Max.		V _F Max.		C _o @ DV (pf)	t _{rr} (nsec)	Package Type	Package Outline No.
		(nA)	@ V _R (V)	(V)	@ I _F (mA)				
1N4451	40	50	30	1.00	300	6	10	D035	38
1N4607	85	100	50	1.00	400	4	10	D035	38
1N4608	85	100	50	.96	400	4	10	D035	38
DT230C	300	1000	300	1.20	250	5	300	D035	38
DT230H	250	1000	250	1.00	200	5	300	D035	38
DT230HI	250	1000	250	1.10	250	5	300	D035	38
DT230B	200	1000	200	1.10	250	5	300	D035	38
DT230G	150	1000	150	1.10	250	5	300	D035	38
DT230A	100	1000	100	1.10	250	5	300	D035	38
DT230F	50	1000	50	1.10	250	5	300	D035	38

LOW LEAKAGE DIODES

DIODES A FAIBLE COURANT DE FUITE
DIODEN MIT NIEDRIGEM LECKSTROM

Part Number	BV @ 100 μ A Min. (V)	I _R @ 25°C Max.		V _F Max.		C _o @ DV (pf)	t _{rr} (nSEC)	Package Outline	Package Outline Number
		(nA)	@ V _R (V)	(V)	@ I _F (mA)				
DE104	40	.02	20	.890	10	4	200	D035	38
DE110	40	2	30	.880	10	4	200	D035	38
DE111	40	.2	20	.880	10	4	200	D035	38
DE112	40	.1	20	1.0	50	6	200	D035	38
DE113	40	.25	20	1.0	50	6	200	D035	38
DE114	40	1	30	.880	10	4	200	D035	38
DE115	40	2	50	.880	10	4	200	D035	38

UNIUNCTIONS, SWITCHES AND TRIGGERS
 UNIUNCTIONS ET DISPOSITIFS DE DECLENCHEMENT
 UNIUNCTIONS, SCHALTER UND TRIGGER

I_S	SWITCHING CURRENT COURANT DE DECLENCHEMENT SCHALTSTROM
I_B	FORWARD BLOCKING CURRENT COURANT DE FUITE LECKSTROM
V_F	FORWARD VOLTAGE CHUTE DE TENSION DIRECTE DURCHLASS-SPANNUNG
V_O	PEAK PULSE VOLTAGE TENSION D'IMPULSION CRETE IMPULS-SPITZENSPANNUNG
V_{ACR}	REVERSE VOLTAGE MAX. TENSION INVERSE MAX. MAX. NEGATIVE SPERRSPANNUNG
$I_{F \text{ MAX.}}$	PEAK RECURRENT FORWARD CURRENT COURANT MAX. DIRECT REPETITIF. PERIODISCHER SPITZEN-DURCHLASS-STROM
I_F	CONTINUOUS FORWARD CURRENT COURANT DIRECT CONTINU DAUER-DURCHLASS-STROM
P_r	DISSIPATION PUISSANCE DISSIPEE VERLUSTLEISTUNG
T_C	TEMPERATURE COEFFICIENT OF SWITCHING CURRENT COEFFICIENT DE TEMPERATURE DU COURANT DE DECLENCHEMENT TEMPERATUR-KOEFFIZIENT DES SCHALTSTROMS
V_S	SWITCHING VOLTAGE SEUIL DE DECLENCHEMENT SCHALTSPANNUNG
I_F	PEAK POINT EMITTER CURRENT COURANT PIC D'EMETTEUR EMITTER-SPITZEN-STROM
R_{BBO}	INTERBASE RESISTANCE RESISTANCE INTERBASE BASIS/BASIS-WIDERSTAND
η	INTRINSIC STAND-OFF RADIO RAPPORT INTRINSEQUE VERHÄLTNIS DER BASISSPANNUNGEN
I_V	VALLEY CURRENT COURANT DE VALLEE TAL-STROM
I_{EO}	EMITTER REVERSE CURRENT COURANT INVERSE D'EMETTEUR NEG. EMITTER-SPERRSTROM

UNIUNCTIONS, TRIGGERS AND SWITCHES
UNIUNCTIONS ET DISPOSITIFS DE DECLENCHEMENT
UNIUNCTIONS, SCHALTER UND TRIGGER

CONVENTIONAL UNIUNCTIONS:

- 2N489-494 - PROVED RELIABILITY, MIL SPEC VERSION.
- 2N2646-47 - LOW COST, PROVED HERMETIC SEALED DEVICE.

TRANSISTORS UNIUNCTIONS CONVENTIONNELS:

- 2N489-494 - FIABILITE EPROUVEE, VERSION MILITAIRE
- 2N2646-47 - FAIBLE PRIX, BOITIER HERMETIQUE

KONVENTIONELLE UNIUNCTIONS:

- 2N489-494 - ERWIESENE ZUVERLÄSSIGKEIT, MIL-SPEC-AUSFÜHRUNGEN LIEFERBAR
- 2N2646-47 - PREISGÜNSTIG, HERMETISCH GEKAPSELT.

PROGRAMMABLE UNIUNJECTION TRANSISTOR (PUT):

- VARIABLE THRESHOLD, LOW COST, FAST SWITCHING SPEED, AND CIRCUIT ADJUSTABLE ELECTRICAL CHARACTERISTICS.

TRANSISTOR UNIUNJECTION PROGRAMMABLE (PUT):

- FAIBLE PRIX. COMMUTATION RAPIDE ET CARACTERISTIQUES ELECTRIQUES PROGRAMMABLES.

PROGRAMMIERBARER UNIUNJECTION-TRANSISTOR (PUT):

- PREISGÜNSTIG, VARIABLER SCHWELLENWERT, HOHE SCHALTGESCHWINDIGKEIT, SOWIE DEM JEWEILIGEN SCHALTKREIS ANPASSBARE ELEKTRISCHE WERTE.

COMPLEMENTARY UNIUNJECTION TRANSISTOR:

- ULTIMATE IN TEMPERATURE STABILITY FOR TIMING AND OSCILLATOR APPLICATIONS.

TRANSISTORS UNIUNCTIONS COMPLEMENTAIRES:

- HAUTE STABILITE EN TEMPERATURE - RECOMMANDES POUR TEMPORISATEURS ET OSCILLATEURS.

KOMPLEMENTÄRE UNIUNJECTION-TRANSISTOREN:

- HOHE TEMPERATURSTABILITÄT, FÜR TAKTGEBER- UND OSZILLATORANWENDUNGEN.

SILICON UNILATERAL SWITCH (SUS):

- A STABLE FIXED LOW VOLTAGE THRESHOLD, LOW COST, HIGH PERFORMANCE "FOUR-LAYER DIODE."

DISPOSITIF DE DECLENCHEMENT UNILATERAL AU SILICIUM (SUS):

- SEUIL DE TENSION FAIBLE ET STABLE, BAS PRIX.
- HAUTES PERFORMANCES.

SILIZIUM-UNILATERALSCHALTER (SUS):

- EINE PREISGÜNSTIGE HOCHLEISTUNGS- "VIERSCHICHTDIODE" MIT STABLEM, NIEDRIGEM- SPANNUNGS-SCHWELLENWERT.

SILICON BILATERAL SWITCH (SBS):

- LOW VOLTAGE TRIAC TRIGGER, TWO SILICON UNILATERAL SWITCHES CONNECTED BACK TO BACK.

DISPOSITIF DE DECLENCHEMENT BILATERAL AU SILICIUM (SBS):

- CONSTITUE DE 2 SUS MONTES EN ANTIPARALLELE.

SILIZIUM-BILATERALSCHALTER (SBS):

- EIN NIEDERSPANNUNGS- TRIGGER FÜR TRIACS, BESTEHEND AUS ZWEI GEGENPARALLELEN SILIZIUM-UNILATERALSCHALTERN.

SILICON CONTROLLED SWITCH (SCS):

- HIGH TRIGGERING SENSITIVITY, FOUR-LEAD CAPABILITY FOR MULTIPLE LOADS OR DV/DT SUPPRESSION.

DISPOSITIFS DE DECLENCHEMENT CONTROLES AU SILICIUM (SCS):

- TRES SENSIBLE. BOITIER A 4 SORTIES OFFRANT DE MULTIPLES POSSIBILITES DE CHARGES DIFFERENTES ET D'AMORTISSEMENT DU DV/DT.

SILIZIUM-STEUERSCHALTER (SCS):

- HOHE SCHALTEMPFINDLICHKEIT, 4 ANSCHLUSSMÖGLICHKEITEN FÜR MEHRADRIGE LAST-SCHALTUNGEN ODER DU/DT - DÄMPFUNG.

CONVENTIONAL UNIJUNCTIONS

TRANSISTORS UNIJONCTIONS CONVENTIONNELS

KONVENTIONELLE UNIJUNCTION – TRANSISTOREN

GENERAL ELECTRIC PRODUCES A VERY BROAD LINE OF STANDARD UJT'S. THE TO-5 CERAMIC DISC BAR STRUCTURE DEVICE HAS BEEN THE WORKHORSE OF THE UNIJUNCTION INDUSTRY FOR OVER TEN YEARS. MIL VERSIONS ARE AVAILABLE ON THE 2N489-494 SERIES.

THE PLANAR STRUCTURE TO-18 SERIES OFFERS EXCELLENT VALUE FOR THOSE REQUIRING PROVED, LOW COST UNITS.

GENERAL ELECTRIC OFFRE UNE LARGE GAMME DE TRANSISTORS UNIJONCTIONS CONVENTIONNELS, L'ELEMENT EN BOITIER TO5 SUR SUPPORT CERAMIQUE EN FORME DE DISQUE A ETE APPRECIÉ PENDANT PLUS DE DIX ANS. LA SERIE 2N489-494 EST DISPONIBLE EN VERSION MILITAIRE.

LA STRUCTURE PLANAR DES SERIES EN BOITIER TO18 OFFRE UN BON RAPPORT QUALITE-PRIX.

GENERAL ELECTRIC FABRIZIERT EIN BREITES PROGRAMM VON STANDARD-UNIJUNCTION-TRANSISTOREN. DIE SCHEIBEN-BAUFORM AUF KERAMIK-SUBSTRAT IM TO5 – GEHÄUSE WAR WÄHREND 10 JAHREN DIE AM MEISTEN VERWANDTE. DIE SERIE 2N489-494 IST AUCH IN MILITÄRISCHER AUSFÜHRUNG ERHÄLTICH. DANEBEN STEHT EINE PREISWERTE PLANAR-SERIE IM TO18 – GEHÄUSE ZUR VERFÜGUNG.

APPLICATIONS

- OSCILLATORS
- TIMERS
- SAWTOOTH GENERATORS
- SCR TRIGGERS
- FREQUENCY DIVIDER
- STABLE VOLTAGE SENSING

APPLICATIONS

- OSCILLATEURS
- TEMPORISATEURS
- GENERATEURS DE DENTS DE SCIE
- DISPOSITIFS DE DECLenchEMENT POUR THYRISTORS
- DIVISEURS DE FREQUENCE
- DETECTEUR DE SEUIL

ANWENDUNGEN

- OSZILLATOREN
- ZEITSCHALTUNGEN
- SÄGEZAHNGENERATOREN
- THYRISTORZÜNDSCHALTUNGEN
- FREQUENZTEILER
- SCHWELLWERT-DETEKTOREN

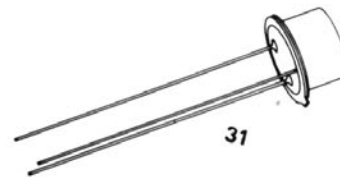
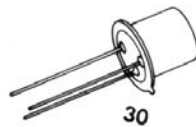

	GE Type	R _{BO} Interbase Resistance @ V _{BB} = 3V I _E = 0 (K Ω)	η Intrinsic Standoff Ratio @ V _{BB} = 10V	I _V Valley Current Min. (mA)	I _P Peak Point Emitter Current Max. (μ A)	I _{EO} Emitter Reverse Current		V _{OB1} Base One Peak Pulse Voltage Min. (V)	Comments	Package
						Max. (μ A)	T _J = 25°C @ V _{BB} E			
TO-5 Bar Structure	2N489	4.7- 6.8	.51-.62	8	12	2	60	—	"A" versions are guaranteed in recommended circuit to trigger GE SCR's over range T _A = -55°C to 125°C.	31
	2N489A *				12	2	60	3		
	2N489B				6	0.2	30	3		
	2N490	6.2- 9.1	.51-.62	8	12	2	60	—		
	2N490A *				12	2	60	3		
	2N490B				6	0.2	30	3		
	2N490C				2	.02	30	3		
	2N491	4.7- 6.8	.56-.68	8	12	2	60	—		
	2N491A *				12	2	60	3		
	2N491B				6	0.2	30	3		
	2N492	6.2- 9.1	.56-.68	8	12	2	60	—		
	2N492A *				12	2	60	3		
	2N492B				6	0.2	30	3		
	2N492C				2	.02	30	3		
2N493	4.7- 6.8	.62-.75	8	12	2	60	—			
2N493A *				12	2	60	3			
2N493B				6	0.2	30	3			
2N494	6.2- 9.1	.62-.75	8	12	2	60	—			
2N494A *				12	2	60	3			
2N494B				6	0.2	30	3			
2N494C				2	.02	30	3			
2N1671	4.7- 9.1	.47-.62	8	25	12	30	—	Industrial types.	31	
2N1671A				25	12	30	3			
2N1671B				6	0.2	30	3			
2N1671C				2	.02	30	3			
2N2160	4.0-12.0	.47-.80	8	25	12	30	3	General purpose—low cost.	31	
TO-18 Cube Structure	2N2646	4.7- 9.1	.56-.75	4	5	12	30	3	General purpose.	30
	2N2647	4.7- 9.1	.68-.82	8	2	0.2	30	6	For long timing periods and triggering high current SCR's.	30
	D5J-43	4.7- 9.1	.68-.82	6	2	1	30	5	General purpose.	30
	D5J-44	4.7- 9.1	.68-.82	4	5	12	30	4	General purpose—low cost.	30
	2N2840	4.7- 9.1 ²	.62 Typical	.2	10	1	30	—	For 1.5 volt applications.	30

* JAN & JANTX types available

² V_{BB} = 1.5V

PROGRAMMABLE UNIJUNCTIONS (PUT – D13T SERIES)

TRANSISTORS UNIJUNCTIONS PROGRAMMABLES (PUT SERIE 13T)

PROGRAMMIERBARE UNIJUNCTION TRANSISTOREN (TYPENREIHE D13T)

THE 2N6028 IS SPECIFICALLY CHARACTERIZED FOR LONG INTERVAL TIMERS AND OTHER APPLICATIONS REQUIRING LOW LEAKAGE AND LOW PEAK POINT CURRENT. THE 2N6027 HAS BEEN CHARACTERIZED FOR GENERAL USE WHERE THE LOW PEAK POINT CURRENT OF THE 2N6028 IS NOT ESSENTIAL.

LE 2N6028 EST CARACTERISE SPECIFIQUEMENT POUR LES TEMPORISATEURS A INTERVALLES LONGS ET POUR LES APPLICATIONS EXIGEANT UN FAIBLE COURANT DE FUITE ET UN FAIBLE COURANT DE PIC. LE 2N6027 EST CARACTERISE POUR UNE UTILISATION GENERALE OU LE FAIBLE COURANT DE FUITE DU 2N6028 N'EST PAS ESSENTIEL.

DER 2N6028 EIGNET SICH BESONDERS FÜR IMPULSGEBER MIT LÄNGEREN ZEITINTERVALLEN UND SOLCHEN MIT NIEDRIGEM LECK- UND SCHEITELSTROM. DER 2N6027 EIGNET SICH FÜR SOLCHE ANWENDUNGEN, WO DER NIEDRIGE SCHEITELSTROM DES 2N6028 NICHT ERFORDERLICH IST.

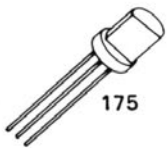

JEDEC Types	Gate to Anode Reverse Voltage Max. (V)	DC Anode Current Max. (mA)	Peak Anode Current 20 μ sec. 1% D.C. Max. (A)	I_{GAO} Leakage Current @ 40V Max. (nA)	Pk. Point Current Max.		I_V Valley Current Min. @ $R_G = 10\text{ k}$ (μ A)	V_O Output Voltage Min. (V)	t_r Pulse Rate of Rise Max. (nsec.)	Package
					@ $R_G = 10\text{ k}$ (μ A)	@ $R_G = 1\text{ Meg.}$ (μ A)				
2N6027	40	150	2	10	5	2	70	6	80	175
2N6028	40	150	2	10	1	.15	25	6	80	175

COMPLEMENTARY UNIJUNCTIONS (D5K SERIES)

UNIJUNCTIONS COMPLEMENTAIRES (SERIE D5K)

KOMPLEMENTÄRE UNIJUNCTIONS (TYPENREIHE D5K)

THE D5K OFFERS THE ULTIMATE IN UNIJUNCTION STABILITY AND UNIFORMITY. LOW FREQUENCY OSCILLATORS AND TIMERS CAN BE BUILT USING THE D5K WITH BETTER THAN 1.0% ACCURACY OVER EXTENDED TEMPERATURE RANGES. THE D5K HAS CHARACTERISTICS LIKE THOSE OF A STANDARD UNIJUNCTION EXCEPT THE CURRENTS AND VOLTAGES APPLIED TO IT ARE OF OPPOSITE POLARITY THAN THOSE OF THE STANDARD DEVICES.

LES UNIJUNCTIONS DE LA SERIE D5K OFFRENT LES MEILLEURES CARACTERISTIQUES DU POINT DE VUE STABILITE ET UNIFORMITE. LES OSCILLATEURS DE TRES BASSE FREQUENCE ET LES TEMPORISATEURS UTILISANT CES DISPOSITIFS ONT UNE STABILITE DE L'ORDRE DE 1% SUR UNE LARGE GAMME DE TEMPERATURE (DE -55 A +150°C). CES ELEMENTS ONT DES CARACTERISTIQUES SIMILAIRES A CELLES DES TRANSISTORS UNIJUNCTIONS CONVENTIONNELS, A CETTE DIFFERENCE PRES QUE TENSION ET COURANT APPLIQUES SONT DE POLARITE INVERSE.

DIE D5K – TYPEN SIND DIE NEUESTE ENTWICKLUNG HINSICHTLICH STABILITÄT UND GERINGER FERTIGUNGSSTREUUNG. NIEDERFREQUENZ-OSZILLATOREN UND ZEITSCHALTUNGEN KÖNNEN MIT DEM D5K MIT EINEM GENAUIGKEITSFAKTOR VON BESSER ALS 1.0% ÜBER EINEN WEITEN TEMPERATURBEREICH BESTÜCKT WERDEN. DIE D5K – TYPEN WEISEN DIE GLEICHEN MERKMALE WIE STANDARDTYPEN AUF, NUR DASS STROM UND SPANNUNG UMGEKEHRTER POLARITÄT SIND.

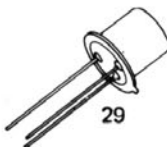

GE Type	R_{EO} Interbase Resistance @ $I_{B2} = 0.1\text{ mA}$ k Ω	η Intrinsic Standoff Ratio	I_V Valley Current Min. (mA)	I_P Peak Point Emitter Current Max. (μ A)	I_{EO} Emitter Reverse Current Max. (nA)	V_O Peak Pulse Voltage Min. (V)	Operating Temp. Range Top ($^{\circ}$ C)	Frequency Stability from 25 $^{\circ}$ C -55 to +150 $^{\circ}$ C %	Package
D5K1	5.5-8.2	.58-.62	1	5	10	3.5	-55 to +150	1.0	29
D5K2	5-15	.58-.62	1	15	10	3.5	-55 to +100	2.0	29

SILICON CONTROL SWITCHES
 DISPOSITIFS DE DECLENCHEMENT AU SILICIUM
 SILIZIUM-STEUERSCHALTER

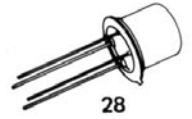

GE Type	V _{AK} Anode Voltage Blocking (V)	I _F Continuous DC Forward Current (mA)	Peak Recurrent Forward Current @ 100μsec (A)	Cathode Gate Peak Current (mA)	P _T (mW)	Cutoff Charac- teristics		Con- ducting Charac- teristics		Max. Gate Ratings		Gate triggering Characteristics			Package
						I _S @ V _{AK} R _{GK} = 10KΩ, 150°C (μA)	I _H R _{GK} = 10KΩ, (mA)	V _{GK} I _{GK} = 20μA (V)	V _{GA} I _{GA} = 1μA (V)	I _{GK} @ V _{AK} =40V, R _L =800Ω, R _{GA} =∞ (μA)	V _{GK} (V)	I _{STA} @ V _{AK} =40V, R _L =800Ω, R _{GK} =10K (mA)	V _{GTA} (V)		
3N81	65	200	1.0	500	400	20	1.5	5	65	1.0	.4 to .65	1.5	-.4 to -.8	28	
3N82	100	200	1.0	500	400	20	1.5	5	100	1.0	.4 to .65	1.5	-.4 to -.8	28	
3N83	70	50	0.1	50	200	20 *	4.0 †	5	70	150 †	.4 to .80	—	—	28	
3N84	40	175	0.5	100	320	20 *	2.0	5	40	10	.4 to .65	—	—	28	
3N85	100	175	0.5	100	320	20 *	2.0	5	100	10	.4 to .65	—	—	28	
3N86	65	200	1.0	500	400	20	0.2	5	65	1.0	.4 to .65	0.1	-.4 to -.8	28	

* Measured @125°C. † Measured in special test circuit (See specification sheet).

SILICON UNILATERAL AND BILATERAL SWITCHES
 DISPOSITIFS DE DECLENCHEMENT UNILATERAL ET BILATERAL AU SILICIUM
 SILIZIUM-UNILATERAL- UND BILATERAL-SCHALTER

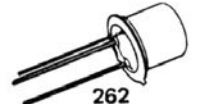
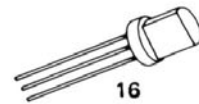

GE Type	V _{ACR} Reverse Voltage Max. (V)	I _F Continuous Forward Current Max. (mA)	I _F Peak Recurrent Forward Current @ 100°C, 10 μs, 1% duty cycle (A)	P _T Dissipation (mW)	T _C Temperature Coefficient of Switching Voltage (%/°C)	V _S Switching Voltage		I _S Switching Current Max. (μA)	I _B Forward Blocking Current @ 5V (μA)	V _F Forward Voltage @ 200mA (V)	I _H Holding Current (mA)	V _O Peak Pulse Voltage Min. (V)	Package	
						Min. (V)	Max. (V)							
Unilateral	2N4987	30	175	1.0	300	—	6	10	500	1.0	1.5	1.5	3.5	16
	2N4988	30	200	1.0	350	±.05	7.5	9	150	0.1	1.5	.5	3.5	
	2N4989	30	200	1.0	350	±.02	7.5	8.2	300	0.01	1.5	1.0	3.5	H
	2N4990	30	175	1.0	300	—	7	9	200	0.1	1.5	.75	3.5	
	2N4983	30	175	1.0	300	—	6	10	500	1.0	1.5	1.5	3.5	G
	2N4984	30	200	1.0	350	±.05	7.5	9	150	0.1	1.5	.5	3.5	
	2N4985	30	200	1.0	350	±.02	7.5	8.2	300	0.01	1.5	1.0	3.5	
	2N4986	30	175	1.0	300	—	7	9	200	0.1	1.5	.75	3.5	
Bilateral	2N4991	—	175	1.0	300	—	6	10	500	1.0	1.7	1.5	3.5	16
	2N4992	—	200	1.0	350	±.05	7.5	9	120	0.1	1.7	.5	3.5	
	2N4993	—	175	1.0	300	—	6	10	500	1.0	1.7	1.5	3.5	262

OPTOELECTRONICS
OPTO ELECTRONIQUE
OPTO-ELEKTRONIK

CTR	CURRENT TRANSFER RATIO. RAPPORT DE TRANSFERT DE COURANT. STROM-ÜBERTRAGUNGSVERHÄLTNIS.
di/dt	CRITICAL RATE-OF-RISE OF CURRENT RATING OF A THYRISTOR. HIGHER RATES MAY CAUSE CURRENT CROWDING AND DEVICE DAMAGE. VOIR CHAPITRE SCR. KRIT. STROMSTIELHEIT.
dv/dt	CRITICAL RATE-OF-RISE OF VOLTAGE PARAMETER OF A THYRISTOR. HIGHER RATES MAY CAUSE DEVICE TURN-ON VIA JUNCTION CAPACITANCE CHARGING CURRENTS PROVIDING GATE SIGNAL. VOIR CHAPITRE SCR. KRIT. SPANNUNGSSTIELHEIT.
H_E	EFFECTIVE IRRADIANCE. THE IRRADIANCE PERCEIVED BY A GIVEN RECEIVER, USUALLY IN EFFECTIVE WATTS PER UNIT AREA. IRRADIANCE EFFECTIVE. EFFEKTIVER STRAHLUNGSFLUSS.
I_L	LIGHT CURRENT. THE CURRENT THROUGH AN ILLUMINATED PHOTODETECTOR AT SPECIFIED BIAS CONDITIONS. COURANT DETECTE, DU A L'ILLUMINATION. HELLSTROM.
I_F	FORWARD BIAS CURRENT, USUALLY OF I_{RED}. SUBSCRIPTS DENOTE MEASUREMENT OR STRESS BIAS CONDITION. IF REQUIRED. COURANT DIRECT DANS LA DIODE. DURCHLASS-STROM.
I_D	DARK CURRENT. THE LEAKAGE CURRENT OF AN UNILLUMINATED PHOTODETECTOR. COURANT D'OBSCURITE. DUNKELSTROM.
W (λ)	WAVELENGTH OF RADIATION. LONGUEUR D'ONDE D'IRRADIATION WELLENLÄNGE DER STRAHLUNG

INFRARED EMITTERS
 EMETTEURS INFRAROUGES
 INFRAROT-SENDER

GE TYPE	MIN. P _O @ I _F = 100mA	MAX. V _F @ I _F = 100mA	PEAK EMISSION WAVE LENGTH TYP. η . METERS	RISE TIME TYP. η . SEC.	FALL TIME TYP. η . SEC.	MAX. P _D mW	MAX. I _F CONT. mA
LED55C	5.4mW	1.7V	940	300	200	1300	100
LED55B	3.5mW	1.7V	940	300	200	1300	100
LED56	1.5mW	1.7V	940	300	200	1300	100
1N6264	6.0mW	1.7V	940	300	200	1300	100
1N6266	*	1.7V	940	300	200	1300	100
1N6265	6.0mW	1.7V	940	300	200	1300	100
LED55CF	5.4mW	1.7V	940	300	200	1300	100
LED55BF	3.5mW	1.7V	940	300	200	1300	100
LED56F	1.5mW	1.7V	940	300	200	1300	100

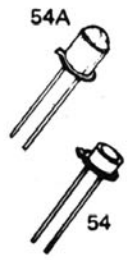

*25 Min./St. Min.

DETECTORS
 DETECTEURS
 EMPFÄNGER

PHOTO TRANSISTORS
 PHOTO TRANSISTORS
 FOTOTRANSISTOREN

GE TYPE	SENSITIVITY (ma/mw/cm ²)		BV _{CEO} (V)	BV _{BCO} (V)	I _D (nA) MAX.	SWITCHING TYP.		TYP. V _{CE(SAT)}
	MIN.	MAX.				t _r (μ SEC.)	t _f (μ SEC.)	
L14G1	.6	—	45	45	100	5	5	.4
L14G2	.3	—	45	45	100	5	5	.4
L14G3	1.2	—	45	45	100	5	5	.4
L14H1	.05	—	60	60	100	5	5	.4
L14H2	.2	—	30	30	100	5	5	.4
L14H3	.2	—	60	60	100	5	5	.4
L14H4	.05	—	30	30	100	5	5	.4



PHOTO DARLINGTONS
 PHOTO DARLINGTONS
 FOTODARLINGTONS

2N5777	.25	—	25	25	100	75	50	.8
2N5778	.25	—	40	40	100	75	50	.8
2N5779	1.0	—	25	25	100	75	50	.8
2N5780	1.0	—	40	40	100	75	50	.8
L14F1	15.0	—	25	25	100	75	50	.8
L14F2	5.0	—	25	25	100	75	50	.8



PHOTO SWITCHES
 PHOTO THYRISTORS
 FOTOTHYRISTOREN

GE TYPE	IRRADIANCE TO TRIGGER (mw/cm ²)		BLOCKING VOLTAGE	I _D (nA) MAX.	V _r (V)
L8	—	10	25-200	10 μ A	1.4
L9	—	4.2	25-200	10 μ A	1.4

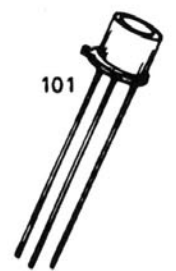

OPTO COUPLERS
PHOTO COUPLEURS
OPTOKOPPLER

WITH PHOTO TRANSISTOR OUTPUT
AVEC PHOTO TRANSISTOR EN SORTIE
MIT FOTO-TRANSISTOR-AUSGANG

GE TYPE	ISOLATION VOLTAGE (V _{pk}) MIN.	CURRENT TRANSFER RATIO MIN.	I _D (nA) MAX.	BV _{CEO} (VOLTS) MIN.	TYPICAL (μSEC.)		V _{CE(SAT)} MAX.
					T _R	T _F	
H11A1	2500	50%	50	30	2	2	.4
H11A2	1500	20%	50	30	2	2	.4
H11A3	2500	20%	50	30	2	2	.4
H11A4	1500	10%	50	30	2	2	.4
H11A5	1500	30%	100	30	2	2	.4
H11A520	5656	20%	50	30	2	2	.4
H11A550	5656	50%	50	30	2	2	.4
H11A5100	5656	100%	50	30	2	2	.4
H15A1	4000 V _{RMS}	20%	100	30	3	3	.4
H15A2	4000 V _{RMS}	10%	100	30	3	3	.4
4N25	2500	20%	50	30	3	3	.5
4N25A	1775 V _{RMS}	20%	50	30	3	3	.5
4N26	1500	20%	50	30	3	3	.5
4N27	1500	10%	50	30	3	3	.5
4N28	500	10%	50	30	3	3	.5
4N35	2500 V _{RMS}	100%	50	30	5	5	.3
4N36	1750 V _{RMS}	100%	50	30	5	5	.3
4N37	1050 V _{RMS}	100%	50	30	5	5	.3
H74A1	1500		100	15			

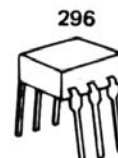
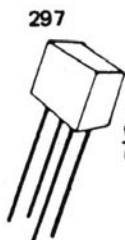

WITH PHOTO SCR OUTPUT
AVEC PHOTOTHYRISTOR EN SORTIE
MIT FOTO-THYRISTOR-AUSGANG

GE TYPE	ISOLATION VOLTAGE MIN.	I _F TRIGGER (MAX.)	I _D 100°C (MAX.) μA	BLOCKING VOLTAGE (MIN.)	TYPICAL TON (μSEC.)	V _F (MAX.)
H11C1	2500	20mA	50	200	1	1.5
H11C2	1500	20mA	50	200	1	1.5
H11C3	1500	30mA	50	200	1	1.5
H11C4	2500	20mA	100	400	1	1.5
H11C5	1500	20mA	100	400	1	1.5
H11C6	1500	30mA	100	400	1	1.5
4N39	1500	14mA	50	200	1	1.5
4N40	1500	14mA	150	400	1	1.5
H74C1	1500			200		
H74C2	1500			400		



PHOTON COUPLED INTERRUPTER MODULE
MODULE INTERRUPTEUR
GABEL-KOPPLER

GE TYPE	OUTPUT CURRENT		I _D (nA)	BV _{ECO} (V)	TYPICAL		V _{CE(SAT)} MAX.
					TON (μSEC)	t _f (μSEC)	
H13A1	I _F = 20mA	200μA	100	30	5	5	.4
H13A2	I _F = 20mA	50μA	100	30	5	5	.4
H13B1	I _F = 20mA	2500μA	100	25	150	150	1.2
H13B2	I _F = 20mA	1000μA	100	25	150	150	1.2
H20A1	I _F = 20mA	200μA	100	30	5	5	.4
H20A2	I _F = 20mA	50μA	100	30	5	5	.4
H20B1	I _F = 20mA	2500μA	100	25	150	150	1.2
H20B2	I _F = 20mA	1000μA	100	25	150	150	1.2

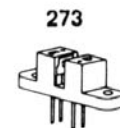

MATCHED EMITTER DETECTOR PAIRS
EMETTEURS-RECEPTEURS APPAIRES
GEPAAARTE SENDER/EMPFÄNGER

H17A1	I _F = 20mA	50μA	100	30	5	5	.4
H17B1	I _F = 20mA	1000μA	100	25	150	150	1.2

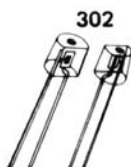

PROGRAMMABLE THRESHOLD COUPLER

PHOTO-COUPLEUR A SEUIL PROGRAMMABLE

PROGRAMMIERBARE SCHWELLENWERT-KOPPLER

GE TYPE	ISOLATION VOLTAGE (V _{pk}) MIN.	CURRENT TRANSFER RATIO MIN.	I _D (nA) MAX.	BV _{CEO} (VOLTS) MIN.	TYPICAL (μSEC.)		V _{CE(SAT)} MAX.
					T _R	T _F	
H11A10	1500	10%	50	30	2	2	.4

296



AC INPUT COUPLER

PHOTO-COUPLEURS A ENTREE SINU SOIDALE

FOTO-KOPPLER MIT WECHSELSTROM-EINGANG

H11AA1	1500	20%	100	30	2	2	.4
H11AA2	1500	10%	200	30	2	2	.4



296

HIGH VOLTAGE COUPLER

PHOTO-COUPLEURS HAUTE TENSION

FOTO-KOPPLER FÜR HÖHERE SPANNUNGEN

H11D1	2500	20%	100	300	5	5	.4
H11D2	1500	20%	100	300	5	5	.4
H11D3	1500	20%	100	200	5	5	.4
H11D4	1500	10%	100	200	5	5	.4
4N38	1500	10%	50	80	5	5	1.0
4N38A	1775 V _{RMS}	10%	50	80	5	5	1.0

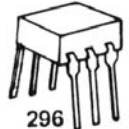

296

WITH PHOTO DARLINGTON OUTPUT

AVEC PHOTO DARLINGTON EN SORTIE

MIT FOTO-DARLINGTON-AUSGANG

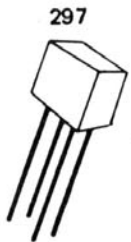

297

H11B1	2500	500%	100	25	125	100	1.0
H11B2	1500	200%	100	25	125	100	1.0
H11B3	1500	100%	100	25	125	100	1.0
H11B255	1500	100%	100	55	125	100	1.0
H15B1	4000 V _{RMS}	400%	100	25	125	100	1.4
H15B2	4000 V _{RMS}	200%	100	25	125	100	1.4
4N29	2500	100%	100	30	5	40	1.0
4N29A	1775 V _{RMS}	100%	100	30	5	40	1.0
4N30	1500	100%	100	30	5	40	1.0
4N31	1500	50%	100	30	5	40	1.2
4N32	2500	500%	100	30	5	100	1.0
4N32A	1775 V _{RMS}	500%	100	30	5	100	1.0
4N33	1500	500%	100	30	5	100	1.0



296



296

BILATERAL ANALOG FET OUTPUT

SORTIE PAR EFFET DE CHAMP

BILATERALER ANALOG-FET-AUSGANG

GE TYPE	ISOLATION VOLTAGE MIN.	ON-STATE RESISTANCE MAX. OHMS	OFF-STATE RESISTANCE MIN. MEGOHMS	BREAKDOWN VOLTAGE ± VOLTS	MAX.		RESISTANCE NON-LINEARITY
					t _{ON} μSEC.	t _{OFF} μSEC.	
H11F1	2500	200	300	30	15	15	0.1%
H11F2	2500	330	300	30	15	15	0.1%
H11F3	1500	470	300	15	15	15	0.1%



296

PRO-ELECTRON OPTOELECTRONIC COUPLERS

COUPLEURS OPTOELECTRONIQUES – SERIE PROELECTRON
PROELECTRON-OPTOKOPPLER

Type	Isolation Voltage (V _{pk}) Min.	Current Transfer Ratio %		I _D (nA)		Comment	Package
		Min. - Max. @ I _f (mA)	V _{CE} (V)	Max. @ V _{CE} , V _{CEO} (V)			
CNY17 I	4000	40- 80	10mA, 5.0	50	10, 70	Tran. Output	296
CNY17 II	4000	63-125	10mA, 5.0	50	10, 70	Tran. Output	296
CNY17 III	4000	100-200	10mA, 5.0	100	10, 70	Tran. Output	296
CNY17 IV	4000	160-320	10mA, 5.0	100	10, 70	Tran. Output	296
CNY47	2800	20- 60	10mA, 0.4	100	10, 30	Tran. Output	296
CNY47A	2800	40-	10mA, 0.4	100	10, 30	Tran. Output	296
CNY51	5000	100-	10mA, 10.0	50	10, 70	Tran. Output	296
CNY48	2100	600-	10mA, 1.0	100	10, 30	Darlington Output	296
CNY35	950	10-	±10mA, 10.0	200	10, 30	AC Input – Tran. Output	296
CNY33	1500	20-	10mA, 10.0	100	200, 300	Hi Volt – Tran. Output	296
CNY28	—	1-	20mA, 10.0	100	10, 30	Tran. Output	273
CNY29	—	12.5-	20mA, 5.0	100	10, 25	Darlington Output	273
CNY32	3500	20-	10mA, 10.0	100	10, 30	Tran. Output	297
CNY31	3500	400-	5mA, 5.0	100	10, 30	Darlington Output	297

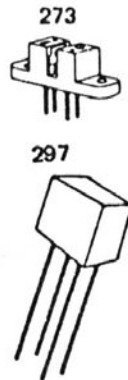

PRO-ELECTRON PHOTO SCR OUTPUT COUPLERS

COUPLEURS OPTOELECTRONIQUES – SERIE PROELECTRON
AVEC THYRISTOR EN SORTIE
PROELECTRON-OPTOKOPPLER MIT THYRISTORAUSGANG

Type	Isolation Voltage (V _{pk}) Min. (10 ms)	I _f Trigger Max. (mA)	I _{DM} , I _{RM} @ 100°C Max.	Blocking Voltage (Min.)	Comment	Package
CNY30	2500	20	50	200	SCR Output	296
CNY34	2500	20	150	400	SCR Output	296

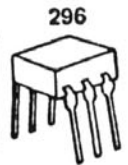

PRO-ELECTRON EMITTERS

PHOTO EMETTEURS – SERIE PROELECTRON
PROELECTRON FOTO-SENDER

Device	Min. P _O (mW) at I _F = 100 mA	Max. V _F at I _F = 100 mA	Typical Peak Emission		Rise Time	Fall Time	Max. P _D	Max. I _F	Package
			WA Length (nm)	Typ. (nS)					
CQX14	5.4mA	1.7V	940	300	200	170	100	54A	
CQX15	5.4mA	1.7V	940	300	200	170	100	54	
CQX16	1.5mA	1.7V	940	300	200	170	100	54A	
CQX17	1.5mA	1.7V	940	300	200	170	100	54	

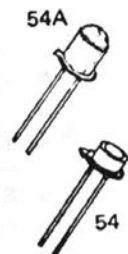

PRO-ELECTRON DETECTORS

PHOTO DETECTEURS – SERIE PROELECTRON
PROELECTRON FOTO-EMPFÄNGER

Device	I _L at	V _{CE} (V)	H (mW/cm sq)	V _{CEO}	I _D (nA)		I _C	I _B	Comment	Package
					Max. @ V _{CE} , V _{CE(SAT)}					
BPW36	6mA, Min.	5V	10.0	45V	100	10V, 0.4V	10mA, 1mA	—	Photo-Transistor	28
BPW37	3mA, Min.	5V	10.0	45V	100	10V, 0.4V	10mA, 1mA	—	Photo-Transistor	28
BPW38	3mA, Min.	5V	0.2	25V	100	12V, —	—	—	Photo-Darlington	28



A NEW OPTOELECTRONICS MANUAL
NOUVEAU MANUEL D'OPTO-ELECTRONIQUE
DAS NEUE OPTOELEKTRONIK-HANDBUCH

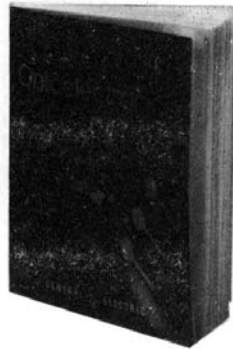

192 PAGE MANUAL, WRITTEN BY GENERAL ELECTRIC APPLICATION ENGINEERS, CONTAINS SEVEN BASIC SELECTIONS OF PRACTICAL, USER-ORIENTED INFORMATION RELATING TO EMITTERS, DETECTORS AND COUPLERS –

CE MANUEL, ECRIT PAR DES INGENIEURS D'APPLICATION, SE DIVISE EN SEPT PARTIES ET TRAITE DE L'UTILISATION PRATIQUE DES EMETTEURS, DETECTEURS ET PHOTOCOUPLEURS:

192 SEITEN, VERFASST VON GE APPLIKATIONSINGENIEUREN, ENTHÄLT IN SIEBEN KAPITELN PRAKTISCHES, ANWENDUNGSORIENTIERTES WISSEN ÜBER SENDER, EMPFÄNGER UND KOPPEL-ELEMENTE IN:

■ THEORY	■ RELIABILITY	■ CIRCUITS
■ THEORIE	■ FIABILITE	■ EXEMPLES D'APPLICATIONS
■ THEORIE	■ VERLÄSSLICHKEIT	■ SCHALTUNGSENTWURF
■ SYSTEM DESIGN	■ MEASUREMENTS	■ SYSTEMS & TERMS
■ CONSIDERATIONS DIVERSES	■ PROCEDES DE MESURES	■ TERMINOLOGIE
■ SYSTEMENTWICKLUNG	■ MESSVERFAHREN	■ SYMBOLE UND BEGRIFFE
	■ SPECIFICATIONS	
	■ SPECIFICATIONS	
	■ DATEN	

AVAILABLE FROM SALES OFFICES AND DISTRIBUTORS LISTED ON THE INSIDE BACK COVER.

S'ADRESSER AUX BUREAUX DE VENTE OU AUX DISTRIBUTEURS GE MENTIONNES AU DOS DU CATALOGUE.

FORDERN SIE EIN EXEMPLAR VON EINEM DER AUF DER RÜCKSEITE AUFGEFÜHRTEN VERKAUFSBÜROS ODER DISTRIBUTOREN.

RECTIFIERS
DIODES DE REDRESSEMENT
GLEICHRICHTER

$I_{F(AV)}$	AVERAGE ON-STATE CURRENT COURANT DIRECT MOYEN DAUERGRENZSTROM
V_{RRM}	MAX. REPETITIVE PEAK REVERSE VOLTAGE TENSION CRETE REPETITIVE HÖCHSTZULÄSSIGE NEGATIVE PERIODISCHE SPITZENSPERRSPANNUNG
$I_{FM(Surge)}$	MAX. PEAK NON-REPETITIVE FORWARD CURRENT COURANT DE SURCHARGE NON-REPETITIF HÖCHSTZULÄSSIGER NICHT-PERIODISCHER STOSS-STROM
I^2T	MAX. NON-REPETITIVE FOR 8.3 ms. VALEUR DE LA CONSTANCE I^2T POUR DUREE DE 8,3 ms. GRENZLASTINTEGRAL, T = 8,3 ms.
T_j	OPERATING JUNCTION TEMPERATURE RANGE GAMME DE TEMPERATURE DE JONCTION EN FONCTIONNEMENT SPERRSCHICHT-TEMPERATURBEREICH
T_{stg}	STORAGE TEMPERATURE RANGE GAMME DE TEMPERATURE DE STOCKAGE LAGER-TEMPERATURBEREICH
V_{FM}	MAX. PEAK FORWARD VOLTAGE CHUTE DE TENSION DIRECTE MAX. DURCHLASS-SPANNUNG
t_{rr}	REVERSE RECOVERY TIME TEMPS DE RECOUVREMENT SPERRERHOLZEIT

FAST RECOVERY RECTIFIER SELECTOR GUIDE
 GUIDE DE SELECTION DES DIODES RAPIDES
 SCHNELLE GLEICHRICHTER – AUSWAHLTABELLE

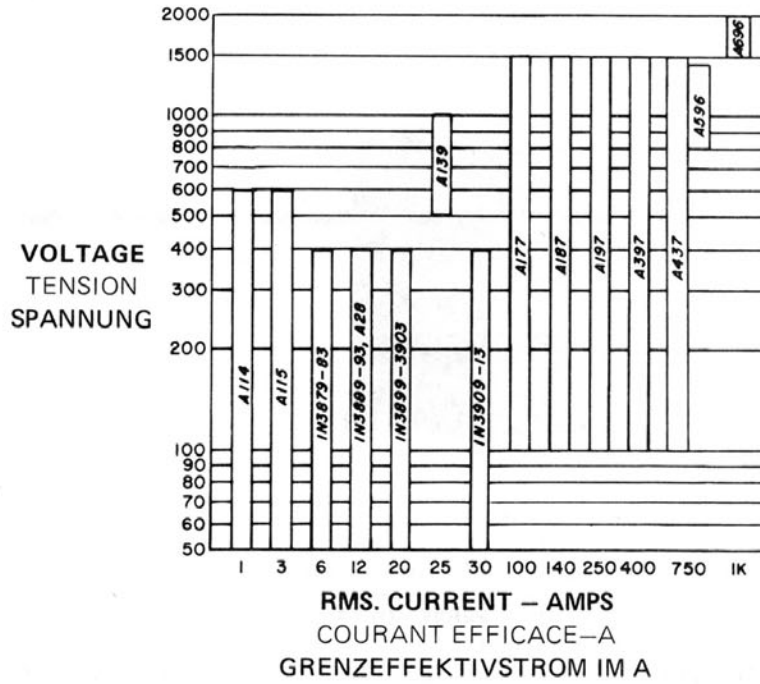

STANDARD RECTIFIER SELECTOR GUIDE
 GUIDE DE SELECTION DES DIODES STANDARDS
 STANDARDMÄSSIGE GLEICHRICHTER – AUSWAHLTABELLE

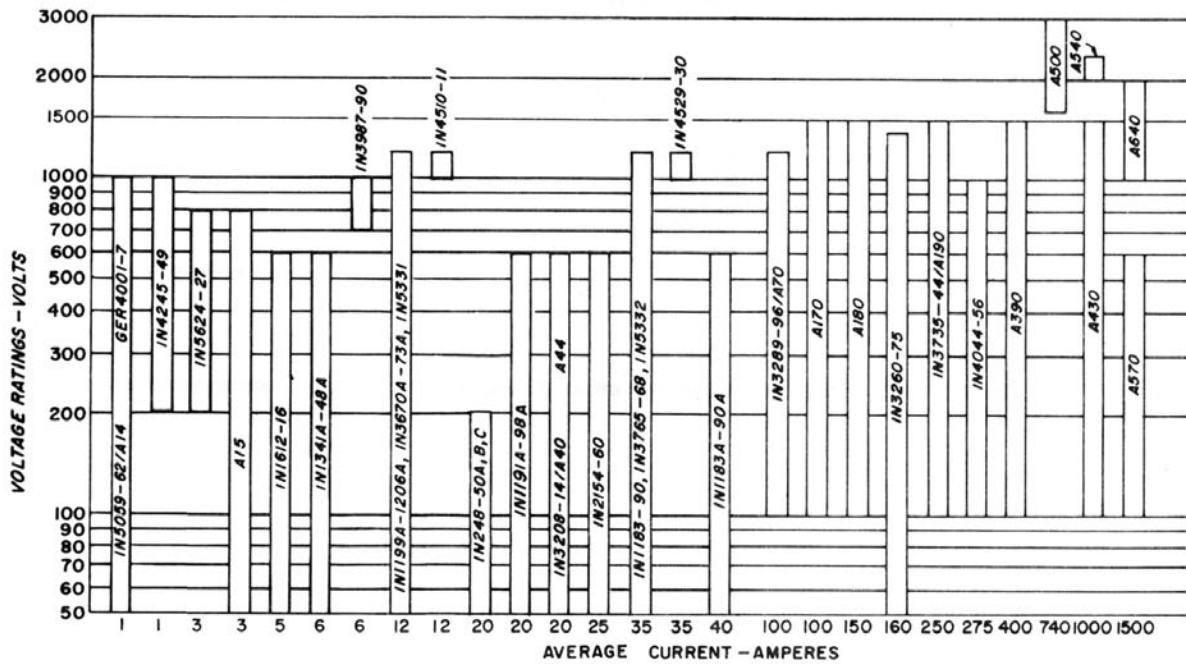

RECTIFIERS DIODES DE REDRESSEMENT GLEICHRICHTER

THE INDUSTRY'S BROADEST LINE OF POWER RECTIFIERS – .250 TO 1500 AMPERES, UP TO 3000 VOLTS

LA PLUS LARGE GAMME DE REDRESSEURS DE PUISSANCE: 250A A 1500A, JUSQU'À, 3000V

UMFANGREICHSTES PROGRAMM VON LEISTUNGSGLEICHRICHTERN: 0,25 – 1500A, BIS ZU 3000V

- | | |
|--|--|
| <ul style="list-style-type: none"> ■ CURRENT/VOLTAGE RATINGS ■ EN COURANT ET TENSION ■ STROM- UND SPANNUNGSWERTE | <ul style="list-style-type: none"> ■ HIGH-SPEED FAST RECOVERY ■ RECOUVREMENT RAPIDE ■ KURZE FREIWERDEZEITEN |
| <ul style="list-style-type: none"> ■ PACKAGING ■ BOITIERS ■ BAUFORMEN | <ul style="list-style-type: none"> ■ TRANSIENT SELF-PROTECTION ■ PROTEGES CONTRE LES TRANSISTOIRES ■ UNEMPFINDLICH GEGEN SPANNUNGSSPITZEN |
| <ul style="list-style-type: none"> ■ MOUNTING AND COOLING ■ MONTAGE ET REFRROIDISSEMENT ■ EINBAU- UND KÜHLUNGS-VORSCHLÄGE | <ul style="list-style-type: none"> ■ GENERAL PURPOSE ■ USAGE GENERAL ■ ALLGEMEINE ANWENDUNGEN |

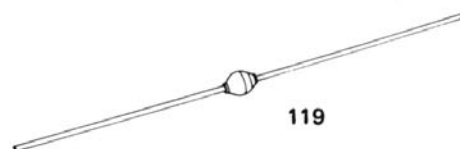
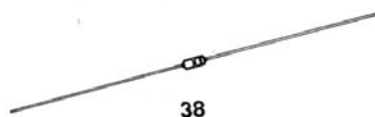
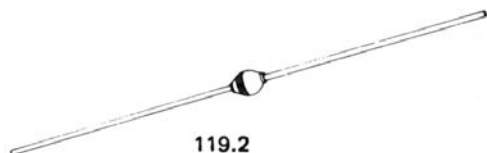

0.25 TO 3 AMPERES

JEDEC		— 1N5059-62 1N4245-49 —			— 1N5624-27 —				
GE TYPE		DT230	A14A-P	—	GER4001-7	A114A-M	—	A15A-N	A115A-M
SPECIFICATIONS									
$I_{FM(AV)}$ (A)		.25	1	1	1	1	3	3	3
	@ $T_A(^{\circ}C)$	50	100	55	75	55	70	70	55
$V_{RM(rep)}$ — Max. repetitive peak reverse voltage (V)									
	50	DT230F	A14F	—	GER4001	A114F	—	A15F	A115F
	100	DT230A	A14A	—	GER4002	A114A	—	A15A	A115A
	150	DT230G	—	—	—	—	—	—	—
	200	DT230B	1N5059	1N4245 *	GER4003	A114B	1N5624	A15B	A115B
	250	DT230H	—	—	—	—	—	—	—
	300	—	A14C	—	—	A114C	—	A15C	A115C
	400	—	1N5060	1N4246 *	GER4004	A114D	1N5625	A15D	A115D
	500	—	A14E	—	—	A114E	—	A15E	A115E
	600	—	1N5061	1N4247 *	GER4005	A114M	1N5626	A15M	A115M
	800	—	1N5062	1N4248 *	GER4006	—	1N5627	A15N	—
	1000	—	A14P ¹	1N4249	GER4007	—	—	—	—
$I_{FM(surge)}$	Max. peak one cycle, non-recurrent surge current (60 Hz sine wave, 1 phase operation) @ max. rated load conditions (A)	5	50	25	30	40	125	125	110
I^2t	Max. non-repetitive for 8.3 msec. (A ² sec)	—	4	4	—	3.5	25	25	20
T_J	Operating junction temperature range (°C)	–65 to 150	–65 to 175 ¹	–65 to 160	–65 to 175	–65 to 125	–65 to 175	–65 to 175	–65 to 150
T_{stg}	Storage temperature range (°C)	–65 to 200	–65 to 175	–65 to 200	–65 to 175	–65 to 175	–65 to 200	–65 to 175	–65 to 175
V_{FM}	Max. peak forward voltage drop @ rated $I_{FM(AV)}$ (1 phase operation)	1.1	1.0	1.2@ +55°C	1.1	1.1	1.0	1.0	1.0
t_{rr}	Max. reverse recovery time (μsec)	0.3	6	5	—	0.2	5	5	0.2
PACKAGE OUTLINE NO.		38	119	119	119	119	119.2	119.2	119.2

NOTE:
¹ Average forward current 1 amp. @ $T_A=90^{\circ}C$. Junction, operating and storage temperature range –65 to +165°C.
 * JAN & JANTX types available

RECTIFIERS DIODES DE REDRESSEMENT GLEICHRICHTER

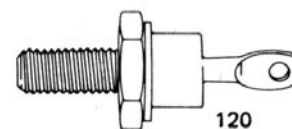

5 TO 12 AMPERES

JEDEC	1N1612-16	1N1341A-48A	1N3987-90	1N3879-83	1N1199A-1206A 1N3670A-73A 1N5331	1N3889-93	1N4510-11	
GE TYPES	-	-	-	-	-	-	A28**	
SPECIFICATIONS								
$I_{FM(AV)}$ (A) @ $T_C = (^\circ C)$	5 150	6 150	6 150	6 100	12 150	12 100	12 135	12 135
$V_{RM(rep)}$ Max. repetitive peak reverse voltage (V)	-	-	-	-	-	-	-	-
50	1N1612	1N1341A	-	1N3879	1N1199A	1N3889	A28F	-
100	1N1613	1N1342A	-	1N3880	1N1200A	1N3890*	A28A	-
150	-	1N1343A	-	-	1N1201A	-	-	-
200	1N1614*	1N1344A	-	1N3881	1N1202A*	1N3891*	A28B	-
300	-	1N1345A	-	1N3882	1N1203A	1N3892	A28C	-
400	1N1615*	1N1346A	-	1N3883	1N1204A*	1N3893*	A28D	-
500	-	1N1347A	-	-	1N1205A	-	-	-
600	1N1616*	1N1348A	-	-	1N1206A*	-	-	-
700	-	-	1N3987	-	1N3670A	-	-	-
800	-	-	1N3988	-	1N3671A*	-	-	-
900	-	-	1N3989	-	1N3672A	-	-	-
1000	-	-	1N3990	-	1N3673A*	-	-	1N4510
1200	-	-	-	-	1N5331	-	-	1N4511
$I_{FM(surge)}$ Max. peak one-cycle, non-recurrent surge current (60 Hz sine wave, 1/ phase operation) @ max. rated load conditions (A)	150	150	150	75	240	150	240	240
$I^2 t$ Max. non-repetitive for 1.0 msec ($A^2 sec$)	25	25	25	-	60	-	67	67
T_J Operating junction temperature range ($^\circ C$)	-65 to +190	-65 to +200	-65 to +200	-65 to +150	-65 to +200	-65 to +150	-65 to +175	-65 to +175
T_{stg} Storage temperature range ($^\circ C$)	-65 to +200	-65 to +200	-65 to +200	-65 to +175	-65 to +200	-65 to +200	-65 to +175	-65 to +200
$R\theta_{JC}$ Max. thermal resistance, junction-to-case ($^\circ C/W$)	7.0	4.25	4.25	2.5	2.5	2.0	2.0	2.0
V_{FM} Max. peak forward voltage drop @ rated $I_{F(AV)}$ (1 phase operation) (V) @ $T_C = (^\circ C)$	1.1 150	1.1 25	1.1 25	1.4 25	1.1 25	1.4 25	1.1 25	1.4 135
T_{rr} Max. reverse recovery time (nsec)	-	-	-	200	-	200	100	-
PACKAGE OUTLINE NO.	120	120	120	120	120	120	120	120

* JAN & JANTX types available.

** A28 reverse polarity is an A29.

RECTIFIERS DIODES DE REDRESSEMENT GLEICHRICHTER

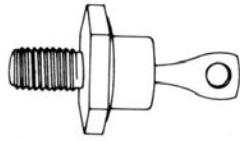

123

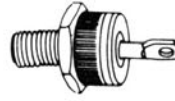

125



126

20 TO 25 AMPERES

JEDEC	1N248B-50B	1N1195A-98A	1N2154-60	1N1183-90 1N3765-68 1N5332	1N4529-30	1N1183A-90A	1N3899-3903	1N3909-13	1N3208-14				
GE TYPE										A40F	A44F	A139	
SPECIFICATIONS													
$I_{FM(AV)}$	Max. average forward current (1 phase operation) (A)		20	20	25	35	35	40	20	30	20	20	25
	@ $T_C = (^{\circ}C)$		150	150	145	140	115	150	100	100	110	110	75
$V_{RM(rep)}$	Max. repetitive peak reverse voltage (V)												
	50	1N248B	1N1191A	1N2154	1N1183	—	1N1183A	1N3899*	1N3909*	1N3208 A40F	A44F	—	
	100	1N249B	1N1192A	1N2155	1N1184*	—	1N1184A	1N3900*	1N3910*	1N3209 A40A	A44A	—	
	150	—	1N1193A	—	1N1185	—	1N1185A	—	—	—	—	—	
	200	1N250B	1N1194A	1N2156	1N1186*	—	1N1186A	1N3901*	1N3911*	1N2110 A40B	A44B	—	
	300	—	1N1195A	1N2157	1N1187	—	1N1187A	1N3902*	1N3912*	1N3211 A40C	A44C	—	
	400	—	1N1196A	1N2158	1N1188*	—	1N1188A	1N3903*	1N3913*	1N3212 A40D	A44D	—	
	500	—	1N1197A	1N2159	1N1189	—	1N1189A	—	—	1N3213 A40E	A44E	A139E	
	600	—	1N1198A	1N2160	1N1190*	—	1N1190A	—	—	1N3214 A40M	A44M	A139M	
	700	—	—	—	1N3765	—	—	—	—	—	—	—	
	800	—	—	—	1N3766	—	—	—	—	—	—	A139N	
	900	—	—	—	1N3767	—	—	—	—	—	—	—	
	1000	—	—	—	1N3768	1N4529	—	—	—	—	—	A139P	
	1200	—	—	—	1N5332	1N4530	—	—	—	—	—	—	
$I_{FM(surge)}$	Max. peak one cycle, non-recurrent surge current (60 Hz sine wave, 1 phase operation) @ max. rated load conditions (A)		350	350	400	500	500	800	225	300	300	300	400
$I^2 t$	Max. $I^2 t$ rating (non-repetitive for 8.3 msec) $A^2 \text{ sec}$		—	—	250	500	500	—	—	—	100	100	500
T_J	Operating junction temperature range ($^{\circ}C$)		-65 to +175	-65 to +175	-65 to +200	-65 to +200	-65 to +175	-65 to +200	-65 to +150	-65 to +150	-65 to +175	-65 to +175	-40 to +125
T_{stg}	Storage temperature range ($^{\circ}C$)		-65 to +175	-65 to +175	-65 to +200	-65 to +200	-65 to +200	-65 to +200	-65 to +175	-65 to +175	-65 to +175	-65 to +175	-40 to +200
$R_{\theta JC}$	Max. thermal resistance, junction-to-case ($^{\circ}C/W$)		1.2	1.2	1.4	1.0	1.0	1.0	1.5	1.0	1.5 Typical	1.5 Typical	1.0
V_{FM}	Max. peak forward voltage drop @ rated $I_{F(AV)}$ (1 phase operation) (V)		1.5	1.2	1.2	1.8	1.4	1.3	1.4	1.4	1.00 Typical	1.00 Typical	1.85
	@ $T_C = (^{\circ}C)$		25	25	145	140	115	25	25	25	25	25	75
T_{rr}	Max. reverse recovery time (nsec)		—	—	—	—	—	—	200	200	—	—	500
PACKAGE OUTLINE NO.			123	123	123	123	123	123	123	125	126	123	

* JAN & JANTX types available.

RECTIFIERS
DIODES DE REDRESSEMENT
GLEICHRICHTER

100 TO 160 AMPERES

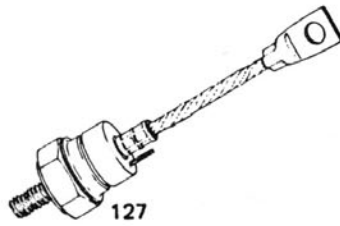

127

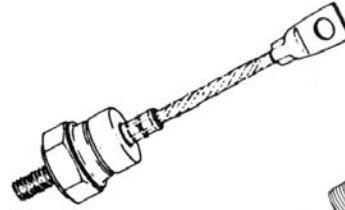

127.1

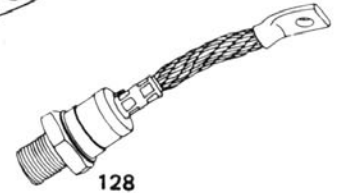

128

JEDEC TYPE		1N3289-96			1N3260-75			
GE TYPE		A70	A170	A177	—	A180	A187	
SPECIFICATIONS								
$I_{FM(AV)}$	Max. average forward current (1 phase operation)	100	100	100	160	150	150	
	$T_C = (^\circ C)$	130	130	130	125	143	110	
V_{RM} (surge)	Max. repetitive peak reverse voltage (V)	—	—	—	—	—	—	
		50	—	—	1N3260	—	—	
		100	A70A	A170A	A177A	1N3261	A180A	A187A
		150	—	—	—	1N3262	—	—
		200	A70B 1N3289	A170B	A177B	1N3263	A180B	A187B
		250	—	—	—	1N3264	—	—
		300	A70C 1N3290	A170C	A177C	1N3265	A180C	A187C
		350	—	—	—	1N3266	—	—
		400	A70D 1N3291	A170D	A177D	1N3267	A180D	A187D
		500	A70E 1N3292	A170E	A177E	1N3268	A180E	A187E
		600	A70M 1N3293	A170M	A177M	1N3269	A180M	A187M
		700	A70S	A170S	A177S	1N3270	A180S	A187S
		800	A70N 1N3294	A170N	A177N	1N3271	A180N	A187N
		900	A70T	A170T	A177T	1N3272	A180T	A187T
		1000	A70P 1N3295	A170P	A177P	1N3273	A180P	A187P
		1100	A70PA	A170PA	A177PA	—	A180PA	A187PA
		1200	A70PB 1N3296	A170PB	A177PB	1N3274	A180PB	A187PB
		1300	—	A170PC	A177PC	—	A180PC	A187PC
		1400	—	A170PD	A177PD	1N3275	A180PD	A187PD
		1500	—	A170PE	A177PE	—	A180PE	A187PE
I_{FM} (surge)	Max. peak one cycle, non-recurrent surge current (60 Hz sine wave, 1 phase operation) @ max. rated load conditions (A)	1600	2500	2500	2000	3400	2800	
I^2t	Max. non-repetitive for 8.3 msec (A^2 sec)	10,000	28,000	23,500	16,000	46,000	33,000	
T_J	Operating junction temperature range ($^\circ C$)	-40 to +200	-40 to +200	-40 to +125	-55 to +190	-40 to +200	-40 to +125	
T_{stg}	Storage temperature range ($^\circ C$)	-40 to +200	-40 to +200	-40 to +200	-55 to +190	-40 to +200	-40 to +200	
$R_{\theta JC}$	Max. thermal resistance, junction-to-case ($^\circ C/W$)	.4	.4	.4	.3	.3	.3	
V_{FM}	Max. Peak forward voltage drop @ rated $I_{F(AV)}$ (1 phase operation)	1.15	1.3	1.3	1.6	1.3	1.7	
	@ $T_C = (^\circ C)$	25	130	25	125	143	25	
Q_{rr}	Max. reverse recovered charge, $T_J = 25^\circ C$	—	—	25	—	—	15	
PACKAGE OUTLINE NO.		127	127.1	127.1	128	127.1	127.1	

RECTIFIERS
DIODES DE REDRESSEMENT
GLEICHRICHTER

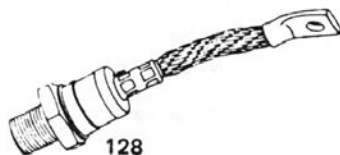

128



109.1



182

250 TO 740 AMPERES

JEDEC	—	1N3735-44	—	1N4044-56	—	—	—
GE TYPE	A190	—	A197	—	A390	A397	A500

SPECIFICATIONS

$I_{FM(AV)}$ Max. average forward current (1 phase operation) (A) @ $T_C = (^\circ C)$	250	250	250	275	400	400	740
$V_{FM(rep)}$ Max. repetitive peak reverse voltage (V)	144	130	110	120	145	110	100
100	A190A	1N3735	A197A	1N4045	A390A	A397A	—
200	A190B	1N3736	A197B	1N4047	A390B	A397B	—
300	A190C	1N3737	A197C	1N4049	A390C	A397C	—
400	A190D	1N3738	A197D	1N4050	A390D	A397D	—
500	A190E	1N3739	A197E	1N4051	A390E	A397E	—
600	A190M	1N3740	A197M	1N4052	A390M	A397M	—
700	A190S	—	A197S	1N4053	A390S	A397S	—
800	A190N	1N3741	A197N	1N4054	A390N	A397N	—
900	A190T	—	A197T	1N4055	A390T	A397T	—
1000	A190P	1N3742	A197P	1N4056	A390P	A397P	—
1100	A190PA	—	A197PA	—	A390PA	A397PA	—
1200	A190PB	1N3743	A197PB	—	A390PB	A397PB	—
1300	A190PC	—	A197PC	—	A390PC	A397PC	—
1400	A190PD	1N3744	A197PD	—	A390PD	A397PD	—
1500	A190PE	—	A197PE	—	A390PE	A397PE	—
1600	—	—	—	—	—	—	A500PM
1700	—	—	—	—	—	—	A500PS
1800	—	—	—	—	—	—	A500PN
1900	—	—	—	—	—	—	A500PT
2000	—	—	—	—	—	—	A500L
2100	—	—	—	—	—	—	A500LA
2200	—	—	—	—	—	—	A500LB
2300	—	—	—	—	—	—	A500LC
2400	—	—	—	—	—	—	A500LD
2500	—	—	—	—	—	—	A500LE
2600	—	—	—	—	—	—	A500LM
2700	—	—	—	—	—	—	A500LS
2800	—	—	—	—	—	—	A500LN
2900	—	—	—	—	—	—	A500LT
3000	—	—	—	—	—	—	A500LP
I_{FM} (surge) Max. peak one cycle, non-recurrent surge current (60 Hz sine wave, 1 phase operation) @ max. rated load conditions (A)	6500	4500	5000	5000	7000	5000	10,000
I^2t Max. non-repetitive for 8.3 msec (A^2 sec)	160,000	84,000	100,000	100,000	200,000	95,000	415,000
T_J Operating junction temperature range ($^\circ C$)	-40 to +200	-40 to +200	-40 to +125	-65 to +190	-40 to +200	-40 to +125	-40 to +175
T_{stg} Storage temperature range ($^\circ C$)	-40 to +200	-40 to +200	-40 to +200	-65 to +200	-40 to +200	-40 to +200	-40 to +200
$R_{\theta JC}$ Max. thermal resistance, junction-to-case ($^\circ C/W$)	.18	.18	.18	.18	.15	.095	.05
V_{FM} Max. peak forward voltage drop @ rated $I_{F(AV)}$ (1 phase operation) @ $T_C = (^\circ C)$	1.3	1.3	1.5	1.35	1.4	1.25	1.25
Q_{rr} Max. reverse recovered charge @ $T_J = 25^\circ C$	—	—	60	—	—	60	—
PACKAGE NO.	128	128	128	128	109.1	109.1	182

RECTIFIERS
DIODES DE REDRESSEMENT
GLEICHRICHTER



182



183
306

750 TO 1500 AMPERES

GE TYPE	A437	A596	A430	A540	A696	A570	A640
JEDEC	-	-	-	-	-	-	-
SPECIFICATIONS							
$I_{FM(AV)}$ Max. average forward current (1 phase operation) (A) @ $T_C = (^\circ C)$	750 65	750 65	1000 126	1000 100	1000 -	1500 80	1500 80
$V_{FM(rep)}$ Max. repetitive peak reverse voltage (V)							
100	A437A	-	A430A	-	-	A570A	-
200	A437B	-	A430B	-	-	A570B	-
300	A437C	-	A430C	-	-	A570C	-
400	A437D	-	A430D	-	-	A570D	-
500	A437E	-	A430E	-	-	A570E	-
600	A437M	-	A430M	-	-	A570M	-
700	A437S	-	A430S	-	-	-	-
800	A437N	A596N	A430N	-	-	-	-
900	A437T	A596T	A430T	-	-	-	-
1000	A437P	A596P	A430P	-	-	-	A640P
1100	A437PA	A596PA	A430PA	-	-	-	A640PA
1200	A437PB	A596PB	A430PB	-	-	-	A640PB
1300	A437PC	A596PC	A430PC	-	-	-	A640PC
1400	A437PD	A596PD	A430PD	-	-	-	A640PD
1500	A437PE	-	A430PE	-	A696PE	-	A640PE
1600	-	-	-	-	A696PM	-	A640PM
1700	-	-	-	-	A696PS	-	A640PS
1800	-	-	-	-	A696PM	-	A640PM
1900	-	-	-	-	A696PT	-	A640PT
2000	-	-	-	A540L	A696L	-	A640L
2100	-	-	-	A540LA	-	-	-
2200	-	-	-	A540LB	-	-	-
2300	-	-	-	A540LC	-	-	-
2400	-	-	-	A540LD	-	-	-
2500	-	-	-	-	-	-	-
2600	-	-	-	-	-	-	-
2700	-	-	-	-	-	-	-
2800	-	-	-	-	-	-	-
2900	-	-	-	-	-	-	-
3000	-	-	-	-	-	-	-
$I_{FM(surge)}$ Max. peak one cycle, non-recurrent surge current (60 Hz sine wave, 1 phase operation) @ max. rated load conditions (A)	10,000	10,000	10,000	12,000	14,000	18,000	16,000
I^2t Max. non-repetitive for 8.3 msec (A^2 sec)	415,000	415,000	415,000	597,000	-	1,300,000	1,062,000
T_J Operating junction temperature range ($^\circ C$)	-40 to +175	-40 to +175	-40 to +200	-40 to +200	-40 to +150	-40 to +200	-40 to +200
T_{stg} Storage temperature range ($^\circ C$)	-40 to +200	-40 to +200	-40 to +200	-40 to +200	-40 to +150	-40 to +200	-40 to +200
$R_{\theta JC}$ Max. thermal resistance, junction-to-case ($^\circ C/W$)	.057	.05	.06	.05	.036	.05	.038
V_{FM} Max. peak forward voltage drop @ rated $I_{F(AV)}$ (1 phase operation) @ $T_C = (^\circ C)$	2.0 25	2.3 125	1.55 25	1.15 150	- -	1.0 25	1.0 25
Q_{rr} Max. reverse recovered charge @ $T_J = 25^\circ C$	100	300	-	-	500	-	-
PACKAGE NO.	183	182	183	182	306	182	306

THYRISTORS
THYRISTORS
THYRISTOREN

$I_{T(RMS)}$	MAX. FORWARD CONDUCTION SINUSOIDAL COURANT EFFICACE A L'ETAT PASSANT GRENZEFFEKTIVSTROM
I_{TSM}	MAX. PEAK ONE CYCLE NON-REPETITIVE SURGE CURRENT (A) COURANT DE SURCHARGE NON REPETITIF HÖCHSTZULÄSSIGER STOSS-STROM
I^2T	MAX. I^2T FOR FUSING FOR 8.3 msec. (A^2 SEC.) VALEUR MAX. DE LA CONSTANTE I^2T POUR 8,3 msec. (A^2 SEC.) GRENZLASTINTEGRAL, T = 8,3 ms.
$I_{T(AV)}$	MAX. AVERAGE ON-STATE CURRENT AT 180° CONDUCTION (A) AT T_C COURANT DIRECT MOYEN EN CONDUCTION A 180° A T_C DAUERGRENZSTROM
V_{TM}	PEAK ON-STATE VOLTAGE AT 125°C, 180° CONDUCTION, RATED $I_{T(AV)}$ (V) CHUTE DE TENSION DIRECTE MAXIMALE DURCHLASS-SPANNUNG
$R_{\theta JC}$	MAX. INTERNAL THERMAL RESISTANCE, DC, JUNCTION-TO-CASE IMPEDANCE THERMIQUE, JONCTION-BOITIER WÄRMEWIDERSTAND SPERRSCHICHT/GEHAUSE
t_q	TYPICAL TURN-OFF TIME (μSEC.) TEMPS DE DESAMORCAGE (μ SEC) FREIWERDEZEIT
$t_d + t_r$	TYPICAL TURN-ON TIME (μSEC.) TEMPS D'ALLUMAGE TYPIQUE (μ SEC) ZÜNDVERZUGSZEIT (TYP. WERT)
DI/DT	RATE-OF-RISE OF TURN-ON CURRENT (A/μSEC.) VITESSE DE CROISSANCE DU COURANT A L'ETAT PASSANT (A/μ SEC) KRITISCHE STROMSTEILHEIT (A/μ S)
T_J	JUNCTION OPERATING TEMPERATURE RANGE GAMME DE TEMPERATURE DE JONCTION SPERRSCHICHT-TEMPERATURBEREICH
DV/DT	MIN. CRITICAL RATE-OF-RISE OF OFF-STATE VOLTAGE VITESSE DE CROISSANCE CRITIQUE DE LA TENSION A L'ETAT BLOQUE MIN. KRITISCHE SPANNUNGS-STEILHEIT
V_{GT}	MAX. REQUIRED GATE VOLTAGE TO TRIGGER TENSION MAX. DE GACHETTE A L'AMORÇAGE OBERE ZÜNDSPANNUNG
I_{GT}	MAX. REQUIRED GATE CURRENT TO TRIGGER COURANT MAX. DE GACHETTE A L'AMORÇAGE OBERER ZÜNDSTROM
I_H	HOLDING CURRENT COURANT DE MAINTIEN HALTESTROM
V_{DRM}	REPETITIVE FORWARD OFF-STATE VOLTAGE TENSION DIRECTE DE CRETE A L'ETAT BLOQUE PERIODISCHE SPITZENPERRSPANNUNG IN VORWARTSRICHTUNG
V_{RRM}	REPETITIVE REVERSE BLOCKING VOLTAGE TENSION INVERSE DE CRETE A L'ETAT BLOQUE PERIODISCHE SPITZENPERRSPANNUNG RUCKWARTSRICHTUNG

PHASE CONTROL SCR'S SELECTOR GUIDE

GUIDE DE SELECTION POUR LES THYRISTORS DE CONTROLE DE PHASE

AUSWAHLTABELLE FÜR NETZGEFÜHRTE THYRISTOREN

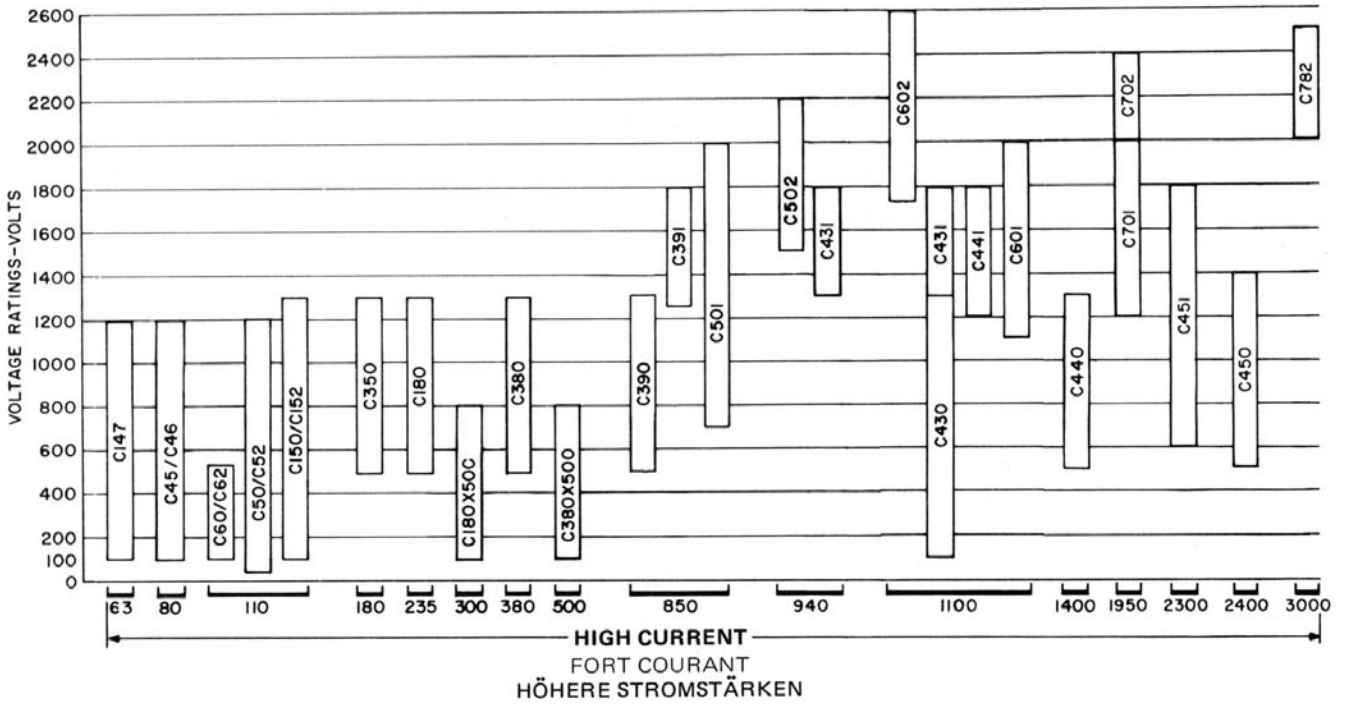
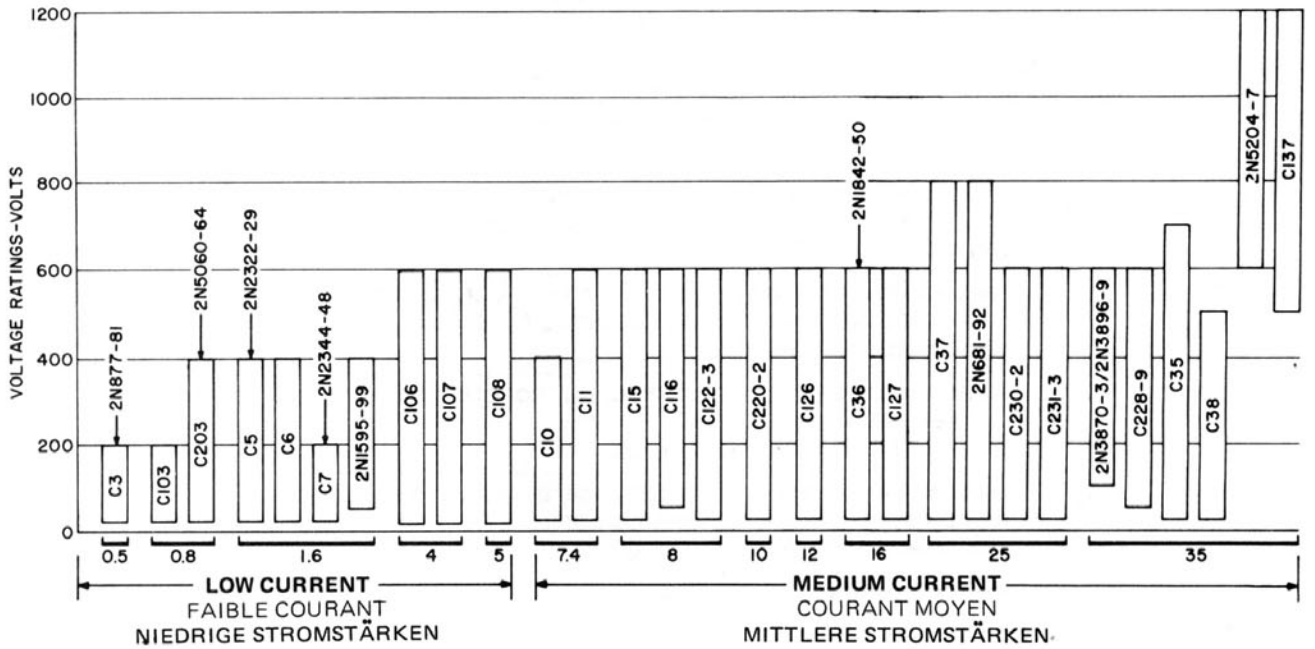

PHASE CONTROL SCR'S
THYRISTORS POUR CONTROLE DE PHASE
NETZGEFÜHRTE THYRISTOREN

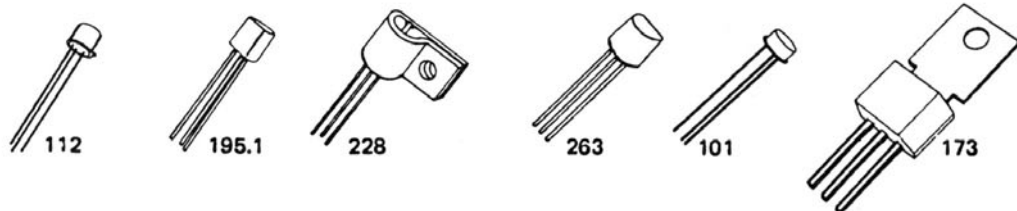

0.5 TO 5 AMPERES

GE TYPE	C3	C103	C203	C5	C6	C7	-	C106	C107	C108
JEDEC	2N877-81 ⁽¹⁾	-	2N5060-64	2N2322-29	-	2N2344-48	2N1595-99, A	-	-	-
ELECTRICAL SPECIFICATIONS										
VOLTAGE RANGE	30-200	30-200	30-400	25-400	25-400	25-200	50-400	15-600	15-600	15-600
FORWARD CONDUCTION										
$I_{T(RMS)}$ Max. RMS on-state current (A)	0.5	0.8	0.8	1.6	1.6	1.6	1.6	4.0	4.0	5.0
$I_{T(AV)}$ Max. average on-state current @ 180° conduction (A) @ T_C	0.32 @ 85° C	0.50 @ 25° C	0.50 @ 25° C	1.0 @ 85° C	1.0 @ 85° C	1.0 @ 55° C	1.0 @ 110° C	2.5 @ 30° C	2.5 @ 20° C	3.75 @ 30° C
I_{TSM} Max. peak one cycle, non-repetitive surge current (A)	7	8	8	15	10	15	15	20	15	30
I^2t Max. I^2t for fusing for > 1.5 msec (A ² sec)	-	-	-	0.5	0.5	-	0.5	0.5	0.5	1
V_{TM} Max. peak on-state voltage @ 25° C, 180° conduction, rated $I_{T(AV)}$ (V)	1.6	1.5	1.5	2.2	1.4	2	2	2.2	2.5	1.35
$R_{\theta JC}$ Max. internal thermal resistance, dc junction-to-case (°C/W)	80	125	75	10	10	-	-	10	10	10
I_H Max. holding current @ 25° C (mA)	5	5	5	2	5	1	-	3	6	3
t_q Typical turn-off time (µsec) @ max. T_J	15	15	15	40	40	20	40	40	40	40
	Maximum turn-off time (µsec @ 110° C)	-	-	-	-	-	-	100	100	100
$t_d + t_r$ Typical turn-on time (µsec @ 110° C)	1	1.4	1.4	1.4	1.4	1.4	1.2	1	1	1
di/dt Max. rate-of-rise of turned-on current (A/µsec)	-	-	-	50	-	-	-	50	50	50
T_J Junction operating temperature range (°C)	-65 to 125	-65 to 125	-65 to 125	-65 to 125	-40 to 125	-65 to 100	-65 to 150	-40 to 110	-40 to 110	-40 to 110
BLOCKING										
dv/dt Typical critical rate-of-rise of off-state voltage, exponential to rated V_{DRM} @ max. rated T_J (V/µsec)	40	20	20	20	20	20	20	8	8	8
FIRING										
I_{GT} Max. required gate current to trigger (µA) @ -65° C	300	500	500	350	-	75	-	-	-	-
	@ -40° C	-	-	-	-	-	-	500	-	500
	@ 25° C	200	200	200	200	1000	20	10,000	200	500
V_{GT} Max. required gate voltage to trigger (V) @ -65° C	-	1	1	1	1	1	-	-	-	-
	@ -40° C	-	-	-	-	1	-	1	-	1
	@ 25° C	0.8	0.8	0.8	0.8	0.8	3	0.8	0.8	0.8
V_{GT} Min. required gate voltage to trigger (V) @ 110° C	-	-	-	-	-	-	-	0.2	0.2	0.2
	@ 125° C	0.05	0.1	0.1	0.1	0.1	-	-	-	-
VOLTAGE TYPES										
Repetitive Peak Forward and Reverse Voltages										
15	-	-	-	-	-	-	-	C106Q1	C107Q1	C108Q1
25	-	-	-	2N2322 C5U	C6U	2N2344	-	-	-	-
30	2N877	C103Y	2N5060 C203Y	-	-	-	-	C106Y1	C107Y1	C108Y1
50	-	-	-	2N2323* C5F	C6F	2N2345	2N1595, A	C106F1	C107F1	C108F1
60	2N878	C103YY	2N5061 C203YY	-	-	-	-	-	-	-
100	2N879	C103A	2N5062 C203A	2N2324* C5A	C6A	2N2346	2N1596, A	C106A1	C107A1	C108A1
150	2N880	-	2N5063	2N2325 C5G	C6G	2N2347	-	-	-	-
200	2N881	C103B	2N5064 C203B	2N2326* C5B	C6B	2N2348	2N1597, A	C106B1	C107B1	C108B1
250	-	-	-	2N2327 C5H	-	-	-	-	-	-
300	-	-	C203C	2N2328* C5C	C6C	-	2N1598, A	C106C1	C107C1	C108C1
400	-	-	C203D	2N2329* C5D	C6D	-	2N1599, A	C106D1	C107D1	C108D1
500	-	-	-	-	-	-	-	C106E1	C107E1	C108E1
600	-	-	-	-	-	-	-	C106M1	C107M1	C108M1
PACKAGE OUTLINE NO.	112	195.1, 228	263	101	101	101	101	173	173	173

*JAN & JANTX types available.
 1. 2N885-89 available 20 mA max. I_{GT} .
 2. 2N2322A-28A available 20 mA max. I_{GT} .

PHASE CONTROL SCRS
THYRISTORS POUR CONTROLÉ DE PHASE
NETZGEFÜHRTE THYRISTOREN

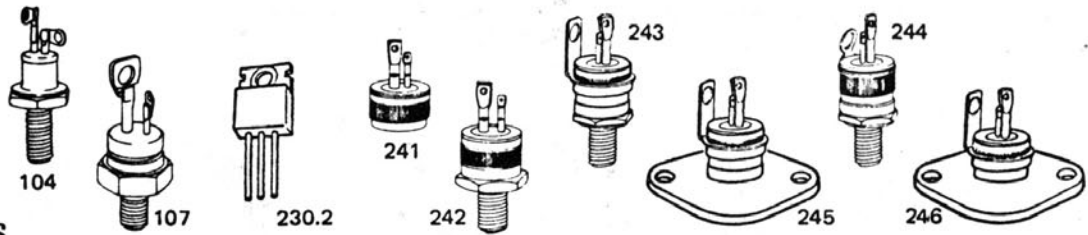

7.4 TO 25 AMPERES

GE TYPE	C10	C11	C15	C122	C220-2	C126	C36	C127	C37
JEDEC	2N1770A-77A	2N1770-78	-	-	-	-	2N1842-50	2N6400-04	-

ELECTRICAL SPECIFICATIONS									
VOLTAGE RANGE	25-400	25-600	25-600	25-600	25-600	25-600	25-600	50-600	25-800

FORWARD CONDUCTION										
$I_{T(RMS)}$	Max. RMS on-state current (A)	7.4	7.4	8	8	10	12	16	16	25
$I_{T(AV)}$	Max. average on-state current @ 180° conduction (A) @ T_C (°C)	4.7 @ 106° C	4.7 @ 105° C	5.1 @ 50° C	5.2 @ 78° C	6.3 @ 68° C	7.8 @ 78° C	10.0 @ 35° C	10.2 @ 100° C	16.0 @ 35° C
I_{TSM}	Max. peak one cycle, non-repetitive surge current (A)	60	60	60	80	90	120	125	160	125
I^2t	Max. I^2t for fusing for ≥ 1.5 msec (A^2 sec)	.5	.5	-	27	27	-	-	100	40
V_{TM}	Max. peak on-state voltage @ 25° C, 180° conduction, rated $I_{T(AV)}$ (V)	1.8	1.8	1.85	2.2	2.0	1.82	2.9	1.7	2.25
$R_{\theta JC}$	Max. internal thermal resistance, dc, junction-to-case (°C/W)	3.1	3.1	3.1	2.0	-	1.8	2.5	1.5	1.0
I_H	Max. holding current @ 25° C (mA)	25	-	30	30	30	30	20	40	10
t_q	Typical turn-off time (μ sec)	-	-	-	-	-	-	50	-	-
	@ 100° C	-	-	-	-	-	-	-	-	-
	@ 125° C	40	40	-	-	-	-	-	-	-
$t_d + t_r$	Typical turn-on time (μ sec)	1.0	1.0	1.0	-	2.5	-	3	-	3
di/dt	Max. rate-of-rise turned-on current (A/μ sec)	60	40	40	100	100	100	20	125	20
T_J	Junction operating temperature range (°C)	-65 to 150	-65 to 125	-65 to 105	-40 to 100	-40 to 100	-40 to 110	-40 to 100	-40 to 125	-40 to 105

BLOCKING										
dv/dt	Typical critical rate-of-rise of off-state voltage. Exponential @ max. rated T_J (V/μ sec)	20	50	50	50	50	50	100	125	100

FIRING										
I_{GT}	Max. required gate current to trigger (mA) @ -65° C	30	30	50	-	-	-	-	-	-
	@ -40° C	-	-	-	40	40	40	150	60	150
	@ 25° C	15	15	35	25	25	25	80	30	80
V_{GT}	Max. required gate voltage to trigger (V) @ -65° C	2	2	2.5	-	-	-	-	-	-
	@ -40° C	-	-	-	2.0	2.0	2.0	3.5	2.5	3.5
	@ 25° C	1.35	1.35	-	1.5	1.5	1.5	-	1.5	-
V_{GT}	Min. required gate voltage to trigger (V) @ 100° C	-	-	0.3	0.2	0.2	-	0.3	-	0.25
	@ 110° C	-	-	-	-	-	0.2	-	-	-
	@ 125° C	-	0.3	-	-	-	-	-	0.2	-
	@ 150° C	0.2	-	-	-	-	-	-	-	-

VOLTAGE TYPES									
Repetitive Peak Forward and Reverse Voltages									
25	2N1770A C10U	2N1770 C11U	C15U	-	C220U C222U	-	2N1842 C36U	-	C37U
50	2N1771A C10F	2N1771 C11F	C15F	C122F	C220F C222F	C126F	2N1843 C36F	2N6400 C127F	C37F
100	2N1772A C10A	2N1772 C11A	C15A	C122A	C220A C222A	C126A	2N1844 C36A	2N6401 C127A	C17A
150	2N1773A C10G	2N1773 C11G	C15G	-	-	-	2N1845 C36G	-	-
200	2N1774A C10B	2N1774 C11B	C15B	C122B	C220B C222B	C126B	2N1846 C36B	2N6402 C127B	C37B
250	2N1775A C10H	2N1775 C11H	C15H	-	-	-	2N1847 C36H	-	-
300	2N1776A C10C	2N1776 C11C	C15C	C122C	C220C C222C	C126C	2N1848 C36C	C127C	C37C
400	2N1777A C10D	2N1777 C11D	C15D	C122D	C220D C222D	C126D	2N1849 C36D	2N6403 C127D	C37D
500	-	2N1778 C11E	C15E	C122E	C220E C222E	C126E	2N1850 C36E	C127E	C37E
600	-	2N2619 C11M	C15M	C122M	C220M C222M	C126M	C36M	2N6404 C127M	C37M
700	-	-	-	-	-	-	C26S	-	C37S
800	-	-	-	-	-	-	C26N	-	C37N
PACKAGE OUTLINE NO.	104	104	104	230, 2	241 (C222) 242, 3, 4, 5, & 6 (C220)	230, 2	107	230, 2	107

PHASE CONTROL SCR'S
THYRISTORS POUR CONTROLE DE PHASE
NETZGEFÜHRTE THYRISTOREN

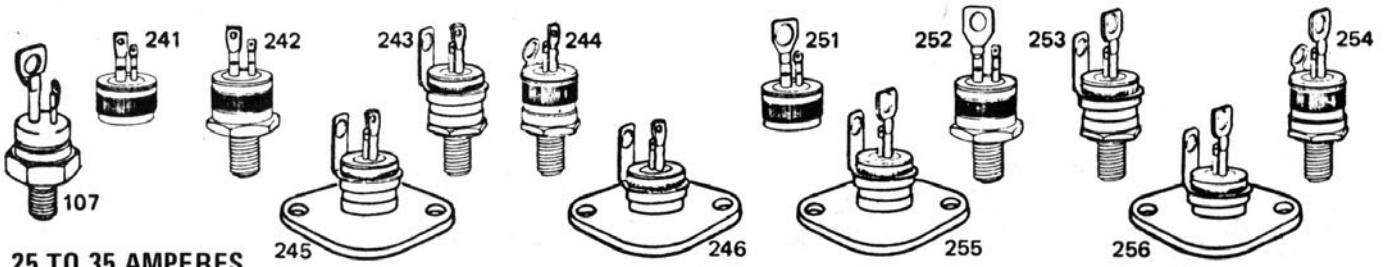

25 TO 35 AMPERES

GE TYPE	-	C230-2	C231-3	-	C228-9	C35	C38	-	C137
JEDEC	2N681-92*	-	-	2N3870-3 2N3896-9	-	-	-	2N5204-7	-

ELECTRICAL SPECIFICATIONS									
VOLTAGE RANGE	25-800	25-600	25-600	100-600	50-600	25-700	25-500	600-1200	500-1200

FORWARD CONDUCTION									
$I_{T(RMS)}$	Max. RMS on-state current (A)	25	25	25	35	35	35	35	35
$I_{T(AV)}$	Max. average on-state current @ 180° conduction (A) @ T_C (°C)	16 @ 65°C	16 @ 70°C	16 @ 70°C	22.5 @ 65°C	20 @ 73°C	22.3 @ 35°C	22.5 @ 70°C	22.3 @ 40°C
I_{TSM}	Max. peak one cycle, non-repetitive surge current (A)	150	300	300	350	300	150	150	300
I^2t	Max. I^2t for fusing for ≥ 1.5 msec. (A ² sec)	75	260	260	260	260	75	75	260
V_{TM}	Peak on-state voltage @ 25°C, 180° conduction, rated $I_{T(AV)}$ (V)	2.0	1.5	1.5	1.85	1.5	1.6	1.6	1.8
$R_{\theta JC}$	Max. internal thermal resistance, dc, junction-to-case (°C/W)	1.7	1.0	1.0	.9	1.7	1.7	1.5	1.5
I_H	Max. holding current @ 25°C (mA)	100	50	50	70	75	100	80	100
t_q	Typical turn-off time (µsec) at rated T_J (max.)	-	-	-	40	-	-	25	-
$t_d + t_r$	Typical turn-on time (µsec)	1.6	3	3	2	-	1.6	1.6	1.6
di/dt	Max. rate-of-rise turned-on current (A/µsec)	80	20	20	100	-	80	80	150
T_J	Junction operating temperature range (°C)	-65 to 125	-40 to 100	-40 to 100	-40 to 100	-40 to 125	-65 to 125	-65 to 150	-40 to 125

BLOCKING									
dv/dt	Typical critical rate-of-rise of off-state voltage. Exponential @ max. rated T_J (V/µsec)	50	100	100	50	50	50	20	200

FIRING										
I_{GT}	Max. required gate current to trigger (mA) @ -65°C	80	-	-	-	-	80	80	-	80
	@ -40°C	-	40	20	80	80	-	-	80	-
	@ 25°C	40	25	9	40	40	40	40	40	40
V_{GT}	Max. required gate voltage to trigger (V) @ -65°C	3.0	-	-	-	-	3.0	3.0	-	3.0
	@ -40°C	-	2.0	2.0	3.0	3.0	-	-	3.0	-
	@ 25°C	3.0	1.5	1.5	2.0	2.5	3.0	3.0	3.0	3.0
V_{GT}	Min. required gate voltage to trigger @ 100°C	-	0.2	0.2	0.2	-	-	-	-	-
	@ 125°C	0.25	-	-	-	0.2	0.25	-	0.25	0.25
	@ 150°C	-	-	-	-	-	-	0.15	-	-

VOLTAGE TYPES

Repetitive Peak Forward and Reverse Voltages									
25	2N681	C230/2U	C231/3U	-	C228/9U	C35U	C38U	-	-
50	2N682*	C230/2F	C231/3F	-	C228/9F	C35F	C38F	-	-
100	2N683*	C230/2A	C231/3A	2N3870 2N3896	C228/9A	C35A	C38A	-	-
150	2N684	-	-	-	-	C35G	C38G	-	-
200	2N685*	C230/2B	C231/3B	2N3871 2N3897	C228/9B	C35B	C38B	-	-
250	2N686*	-	-	-	-	C35H	C38H	-	-
300	2N687*	C230/2C	C231/3C	-	C228/9C	C35C	C38C	-	-
400	2N688*	C230/2D	C231/3D	2N3872 2N3898	C228/9D	C35D	C38D	-	-
500	2N689*	C230/2E	C231/3E	-	C228/9E	C35E	C38E	-	C137E
600	2N690	C230/2M	C231/3M	2N3873 2N3899	C228/9M	C35M	-	2N5204	C137M
700	2N691	-	-	-	-	C35S	-	-	C137S
800	2N692	-	-	-	-	-	-	2N5205	C137N
900	-	-	-	-	-	-	-	-	C137T
1000	-	-	-	-	-	-	-	2N5206	C137P
1100	-	-	-	-	-	-	-	-	C137PA
1200	-	-	-	-	-	-	-	2N5207	C137PB
PACKAGE OUTLINE NO.	107	241 (C232) 2, 3, 4, 5 & 6 (C230)	241 (C233) 2, 3, 4, 5 & 6 (C231)	241 242	251 (C229) 2, 3, 4, 5 & 6 (C228)	107	107	107	107

*JAN & JANTX types available.

PHASE CONTROL SCR'S

THYRISTORS POUR CONTROLE DE PHASE

NETZGEFÜHRTE THYRISTOREN

63 TO 190 AMPERES



108



108.1

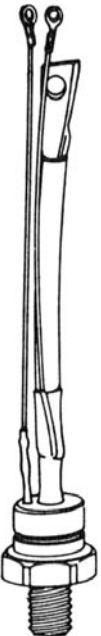

109

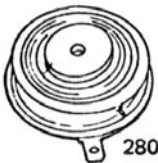

280

GE TYPE	C45, 46	C147	C50, 52	C50X500 C52X500	C150, 152	C60, 62	C350	
JEDEC			2N1909-16 2N1792-98			2N2023-30		
ELECTRICAL SPECIFICATIONS								
VOLTAGE RANGE	25-1200	25-1200	25-1200	100-700	500-1300	25-500	500-1300	
FORWARD CONDUCTION								
I_T (RMS) Max. RMS on-state current (A)	80	63	110	110	110	110	190	
I_T (AV) Max. average on-state current @ 180° conduction (A) @ T _C	52 @ 75°C	40 @ 102°C	70 @ 62°C	70 @ 95°C	70 @ 80°C	70 @ 88°C	110 @ 90°C	
I_T (AV) Max. average on-state current for 3 _v conduction (A) @ T _C	42 @ 35°C	36 @ 101°C	62 @ 65°C	59 @ 95°C	59 @ 87°C	59 @ 90°C	95 @ 85°C	
I_{TSM} Max. peak one cycle, non-repetitive surge current (A)	800	1000	1000	1500	1600	1000	1600	
i^2t Max. I^2t for fusing for 5 to 8.3 msec (A ² sec)	2600	4150	4150	9340	7000	4000	10,600	
V_{TM} Peak on-state voltage @ 125°C, 180° conduction rated I_T (AV) (V)	2.1	1.4	1.8	1.3	2.0	2.0	2.2	
$R_{\theta JC}$ Max. internal thermal resistance, dc, junction-to-case (°C/W)	.4	.35	.4	.3	.3	.4	.135	
t_d Typical turn-off time (μsec)	80	125	80	—	100	80	125	
t_d t_r Typical turn-on time (μsec)	5	5	5	—	8	5	8	
di/dt Rate-of-rise turned-on current (A/μsec)	100	100	100	—	200	30	200	
T _J Junction operating temperature range (°C)	-40 to 125°C	-40 to 125°C	-40 to 125°C	-40 to 125°C	-40 to 125°C	-65 to 150°C	-40 to 125°C	
BLOCKING								
dv/dt Min. critical rate-of-rise of off-state voltage, exponential @ max. rated T _J (V/μsec)	100	200	200	200	200	30 TYP.	200	
FIRING								
I_{GT} Max. required gate current to trigger (mA) @ -40°C	130	300	130	300	200	125	200	
@ 125°C	40	150	40	125	125	40	125	
V_{GT} Max. required gate voltage to trigger (V) @ -40°C	3	3.5	3	3.5	3	3	3	
@ 125°C	.25	.25	.25	.25	.15	.25	.15	
VOLTAGE TYPES								
Repetitive Peak Forward and Reverse Voltages								
25	C45U C46U	C147U	2N1909 C52U	—	CONSULT FACTORY	2N2023 C62U	—	
50	C45F C46F	C147F	2N1910 2N1792	—		2N2024 C62F	—	
100	C45A C46A	C147A	2N1911 2N1793	C50AX500 C52AX500		2N2025 C62A	—	
150	C45G C46G	C147G	2N1912 2N1794	—		2N2026 C62G	—	
200	C45B C46B	C147B	2N1913 2N1795	C50BX500 C52BX500		2N2027 C62B	—	
250	C45H C46H	C147H	2N1914 2N1796	—		2N2028 C62H	—	
300	C45C C46C	C147C	2N1915 2N1797	C50CX500 C52CX500		2N2029 C62C	—	
400	C45D C46D	C147D	2N1916 2N1798	C50DX500 C52DX500		2N2030 C62D	—	
500	C45E C46E	C147E	C50E C52E	C50EX500 C52EX500		C150E C152E	C60E C62E	C350E
600	C45M C46M	C147M	C50M C52M	C50MX500 C52MX500		C150M C152M	—	C350M
700	C45S C46S	C147S	C50S C52S	C50SX500 C52SX500		C150S C152S	—	C350S
800	C45N C46N	C147N	C50N C52N	—		C150N C152N	—	C350N
900	C45T C46T	C147T	C50T C52T	—		C150T C152T	—	C350T
1000	C45P C46P	C147P	C50P C52P	—	C150P C152P	—	C350P	
1100	C45PA C46PA	C147PA	C50PA C52PA	—	C150PA C152PA	—	C350PA	
1200	C45PB C46PB	C147PB	C50PB C52PB	—	C150PB C152PB	—	C350PB	
1300	—	—	—	—	C150PC C152PC	—	C350PC	
PACKAGE TYPE	½" STUD	¼" STUD	½" STUD	½" STUD	½" STUD	½" STUD	½" PRESS PAK	
PACKAGE OUTLINE NO.	108, 109	108.1	109, 108	109, 108	109, 108	109, 108	280	

PHASE CONTROL SCR'S
THYRISTORS POUR CONTROLE DE PHASE
NETZGEFÜHRTE THYRISTOREN

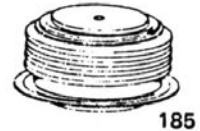
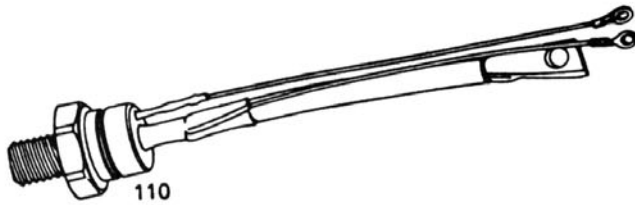

235 TO 850 AMPERES

GE TYPE	C180	C180X500	C380	C380X500	C390	C391	C501	C502
ELECTRICAL SPECIFICATIONS								
VOLTAGE RANGE	500-1300	100-800	100-1300	100-800	500-1300	1300-1800	700-2000	1500-2200
FORWARD CONDUCTION								
$I_{T(RMS)}$ Max. RMS On-State Current (A)	235	300	380	500	800	800	850	850
$I_{T(AV)}$ Max. average on-state current @ 180°C conduction (A) @ T_C	150 @ 88°C	255 @ 70°C	235 @ 80°C	375 @ 70°C	500 @ 50°C	480 @ 65°C	550 @ 67°C	475 @ 67°C
$I_{T(AV)}$ Max. average on-state current for 3 ϕ conduction (A) @ T_C	135 @ 80°C	225 @ 70°C	180 @ 80°C	320 @ 70°C	440 @ 50°C	420 @ 65°C	525 @ 70°C	400 @ 60°C
I_{TSM} Max. peak one cycle, non-repetitive surge current (A)	3500	5500	3500	5500	8000	8000	8000	8000
I^2t Max. I^2t for fusing for 8.3 msec (A ² Sec)	50,000	125,000	50,000	125,000	265,000	265,000	265,000	265,000
V_{TM} Peak on-state voltage @ 125°C, 180° conduction, rated $I_{T(AV)}$ (V)	1.7	1.35	1.8	1.45	2.0	1.9	1.9	1.9
$R_{\theta JC}$ Max. internal thermal resistance, dc, junction-to-case (°C/W)	.14	.14	.095	.095	.06	.06	.06	.06
t_q Typical turn-off time (μsec)	250	250	250	150	125	200	300	125
$t_d + t_r$ Typical turn-on time (μsec)	8	8	8	8	1	1.5	1.5	1.5
di/dt Rate-of-rise of turned-on current (A/μsec)	200	200	200	200	500	150	30-75	100
T_J Junction operating temperature range (°C)	-40 to 125°C	-40 to 125°C	-40 to 125°C	-40 to 125°C	-40 to 125°C	-40 to 125°C	-40 to 125°C	-40 to 125°C
BLOCKING								
dv/dt Min. critical rate-of-rise of off-state voltage, exponential @ max. rated T_J (V/μsec)	200	200	200	200	200	200	(0.8 V_{DRM}) 100	(0.8 V_{DRM}) 500
FIRING								
I_{GT} Max. required gate current to trigger (mA) @ -40°C	200	200	200	200	300	300	225	275
I_{GT} @ 125°C	125	125	125	125	125	125	75	50
V_{GT} Max. required gate voltage to trigger (V) @ -40°C	3	3	3	3	5	5	6.5	4.5
V_{GT} Min. required gate voltage to trigger (V) @ 125°C	.15	.15	.15	.15	.25	.15	.15	.3
VOLTAGE TYPES								
Repetitive Peak Forward and Reverse Voltage								
100		C180AX500	C380A	C380AX500				
200	CONSULT	C180BX500	C380B	C380BX500	CONSULT		CONSULT	
300	FACTORY	C180CX500	C380C	C380CX500	FACTORY		FACTORY	
400		C180DX500	C380D	C380DX500				
500	C180E	C180EX500	C380E	C380EX500	C390E			
600	C180M	C180MX500	C380M	C380MX500	C390M			
700	C180S	C180SX500	C380S	C380SX500	C390S		C501S	
800	C180N	C180NX500	C380N	C380NX500	C390N		C501N	
900	C180T		C380T		C390T		C501T	
1000	C180P		C380P		C390P		C501P	
1100	C180PA		C380PA		C390PA		C501PA	
1200	C180PB		C390PB		C390PB		C501PB	
1300	C180PC		C380PC		C390PC	C391PC	C501PC	
1400						C391PD	C501PD	
1500						C391PE	C501PE	C502PE
1600						C391PM	C105PM	C502PM
1700						C391PS	C501PS	C502PS
1800						C391PN	C501PN	C502PN
1900							C501PT	C502PT
2000							C501L	C502L
PACKAGE TYPE	3/8" STUD	3/8" STUD	1/2" PRESS PAK	1/2" PRESS PAK	PRESS PAK	PRESS PAK	PRESS PAK	PRESS PAK
PACKAGE OUTLINE NO.	110	110	280	280	276	276	185	185

PHASE CONTROL SCR'S
THYRISTORS POUR CONTROLE DE PHASE
NETZGEFÜHRTE THYRISTOREN

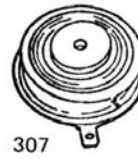
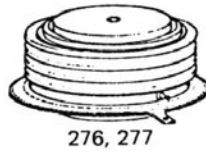

940 TO 1400 AMPERES

GE TYPE	C602	C430	C431	C601	C441	C440
ELECTRICAL SPECIFICATIONS						
VOLTAGE RANGE	1700-2600	500-1300	1300-1800	1100-2000	1300-1800	500-1300
FORWARD CONDUCTION						
$I_{T(RMS)}$ Max. RMS on-state current (A)	940	1000	940	1100	1100	1400
$I_{T(AV)}$ Max. Average on-state current @ 180° conduction (A) @ T_C	600 @ 72° C	700 @ 65° C	670 @ 65° C	750 @ 72° C	800 @ 65° C	850 @ 75° C
$I_{T(AV)}$ Max. average on-state current for 3 ϕ conduction (A) @ T_C	510 @ 80° C	550 @ 65° C	525 @ 65° C	620 @ 80° C	575 @ 80° C	650 @ 80° C
I_{TSM} Max. peak one cycle, non-repetitive surge current (A)	10,000	8,000	8,000	11,000	11,000	13,000
I^2t Max. I^2t for fusing for 8.3 msec. (A ² Sec.)	415,000	265,000	265,000	516,000	500,000	700,000
V_{TM} Peak on-state voltage @ 125° C, 180° conduction, rated $I_{T(AV)}$ (V)	1.9	2.15	2.3	1.5	1.8	1.6
$R_{\theta JC}$ Max. internal thermal resistance, dc, junction-to-case (°C/W)	.036	.04 (2000 lbs.)	.04 (2000 lbs.)	.041	.04	.04
t_q Typical turn-off time (μ sec)	125	125	150	175	125	125
$t_d + t_r$ Typical turn-on time (μ sec)	1.5	1.0	1.0	1.5	1.5	1.5
di/dt Rate-of-rise of turned-on current (A/ μ sec)	35-75	500	150	80-150	150	800
T_J Junction operating temperature range (°C)	-40 to 125° C ←					-40 to 125° C
BLOCKING						
dv/dt Min. critical rate-of-rise of off-state voltage. Exponential @ rated T_J (V/ μ sec)	500 (.67 V_{DRM})	200	200	200	200	200
FIRING						
I_{GT} Max. required gate current to trigger (mA) @ -40° C	275	300	300	275	300	300
I_{GT} @ 125° C	75	125	125	75	125	125
V_{GT} Max. required gate voltage to trigger (V) @ -40° C	4.5	5.0	5.0	4.5	5.0	5.0
V_{GT} Min. required gate voltage to trigger (V) @ 125° C	.2	.35	.35	.2	.15	.15
VOLTAGE TYPES						
Repetitive Peak Forward and Reverse Voltages						
500	—	C430E	—	—	—	C440E
600	—	C430M	—	—	—	C440M
700	—	C430S	—	—	—	C440S
800	—	C430N	—	—	—	C440N
900	—	C430T	—	—	—	C440T
1000	—	C430P	—	—	—	C440P
1100	—	C430PA	—	C601PA	—	C440PA
1200	—	C430PB	—	C601PB	—	C440PB
1300	—	C430PC	C431PC	C601PC	C441PC	C440PC
1400	—	—	C431PD	C601PD	C441PD	—
1500	—	—	C431PE	C601PE	C441PE	—
1600	—	—	C431PM	C601PM	C441PM	—
1700	C602PS	—	C431PS	C601PS	C441PS	—
1800	C602PN	—	C431PN	C601PN	C441PN	—
1900	C602PT	—	—	C601PT	—	—
2000	C602L	—	—	C601L	—	—
2100	C602LA	—	—	—	—	—
2200	C602LB	—	—	—	—	—
2300	C602LC	—	—	—	—	—
2400	C602LD	—	—	—	—	—
2500	C602LE	—	—	—	—	—
2600	C602LM	—	—	—	—	—
PACKAGE TYPE	PRESS PAK	PRESS PAK	PRESS PAK	PRESS PAK	PRESS PAK	PRESS PAK
PACKAGE OUTLINE NO.	277	307	307	277	276	276

PHASE CONTROL SCR'S
THYRISTORS POUR CONTROLE DE PHASE
NETZGEFÜHRTE THYRISTOREN



276.1, 308, 315

1950 TO 3000 AMPERES

GE TYPE	C701	C702	C451	C450	C782	
ELECTRICAL SPECIFICATIONS						
VOLTAGE RANGE	1100-2000	2000-2400	500-1800	500-1400	2000-2400	
FORWARD CONDUCTION						
$I_{T(RMS)}$ Max. RMS on-state current (A)	1950	1950	2300	2400	3000	
$I_{T(AV)}$ Max. average on-state current @ 180° conduction (A) @ T_C	1250 @ 70°C	1250 @ 70°C	1100 @ 80°C	1250 @ 80°C	1875 @ 70°C	
$I_{T(AV)}$ Max. average on-state current for 3 ϕ conduction (A) @ T_C	1000 @ 70°C	1040 @ 80°C	1000 @ 74°C	1075 @ 80°C	1600 @ 70°C	
I_{TSM} Max. peak one cycle, non-repetitive surge current (A)	20,000	15,000	21,280	28,500	31,500	
$I^2 t$ Max. $I^2 t$ for fusing for 8.3 msec. (A ² Sec.)	1,660,000	933,000	1,880,000	3,370,000	2,550,000	
V_{TM} Peak on-state voltage @ 125°C, 180° conduction, rated $I_{T(AV)}$ (V)	2.0	2.0	1.35	1.55	2.3	
$R_{\theta JC}$ Max. internal thermal resistance, dc, junction-to-case (°C/W)	.023	.023	.025	.025	.012	
t_q Typical turn-off time (μ sec.)	125	125	150	150	200	
$t_d + t_r$ Typical turn-on time (μ sec.)	1.5	—	0.7	—	—	
di/dt Rate-of-rise of turned-on current (A/ μ sec)	100	125	75	500	—	
T_J Junction operating temperature range (°C)	-40 to 125°C ←				→ -40 to 125°C	
BLOCKING						
dv/dt Min. critical rate-of-rise of off-state voltage. Exponential @ rated T_J (V/ μ sec.)	200	200	400	200	300	
FIRING						
I_{GT} Max. required gate current to trigger (mA) @ -40°C	275	275	300	300	200	
	@ 125°C	50	35	125	125	35
V_{GT} Max. required gate voltage to trigger (V) @ -40°C	5.5	4.5	5.0	5.0	6.0 @ 0°C	
V_{GT} Min. required gate voltage to trigger (V) @ 125°C	.3	.3	.15	.35	.5	
VOLTAGE TYPES						
Repetitive Peak Forward and Reverse Voltages						
500	—	—	C451E	C450E	—	
600	—	—	C451M	C450M	—	
700	—	—	C451S	C450S	—	
800	—	—	C451N	C450N	—	
900	—	—	C451T	C450T	—	
1000	—	—	C451P	C450P	—	
1100	C701PA	—	C451PA	C450PA	—	
1200	C701PB	—	C451PB	C450PB	—	
1300	C701PC	—	C451PC	C450PC	—	
1400	C701PD	—	C451PD	C450PD	—	
1500	C701PE	—	C451PE	—	—	
1600	C701PM	—	C451PM	—	—	
1700	C701PS	—	C451PS	—	—	
1800	C701PN	—	C451PS	—	—	
1900	C701PT	—	C451PN	—	—	
2000	C701L	C702L	—	—	C782L	
2100	—	C702LA	—	—	C782LA	
2200	—	C702PB	—	—	C782LB	
2300	—	C702LC	—	—	C782LC	
2400	—	C702LD	—	—	C782LD	
2500	—	—	—	—	—	
2600	—	—	—	—	—	
PACKAGE TYPE	PRESS PAK	PRESS PAK	PRESS PAK	PRESS PAK	PRESS PAK	
PACKAGE OUTLINE NO.	276.1	276.1	276.1	308	315	

INVERTER SCR'S SELECTOR GUIDE
 GUIDE DE SELECTION DES THYRISTORS RAPIDES
 FREQUENZ-THYRISTOREN-AUSWAHLTABELLE

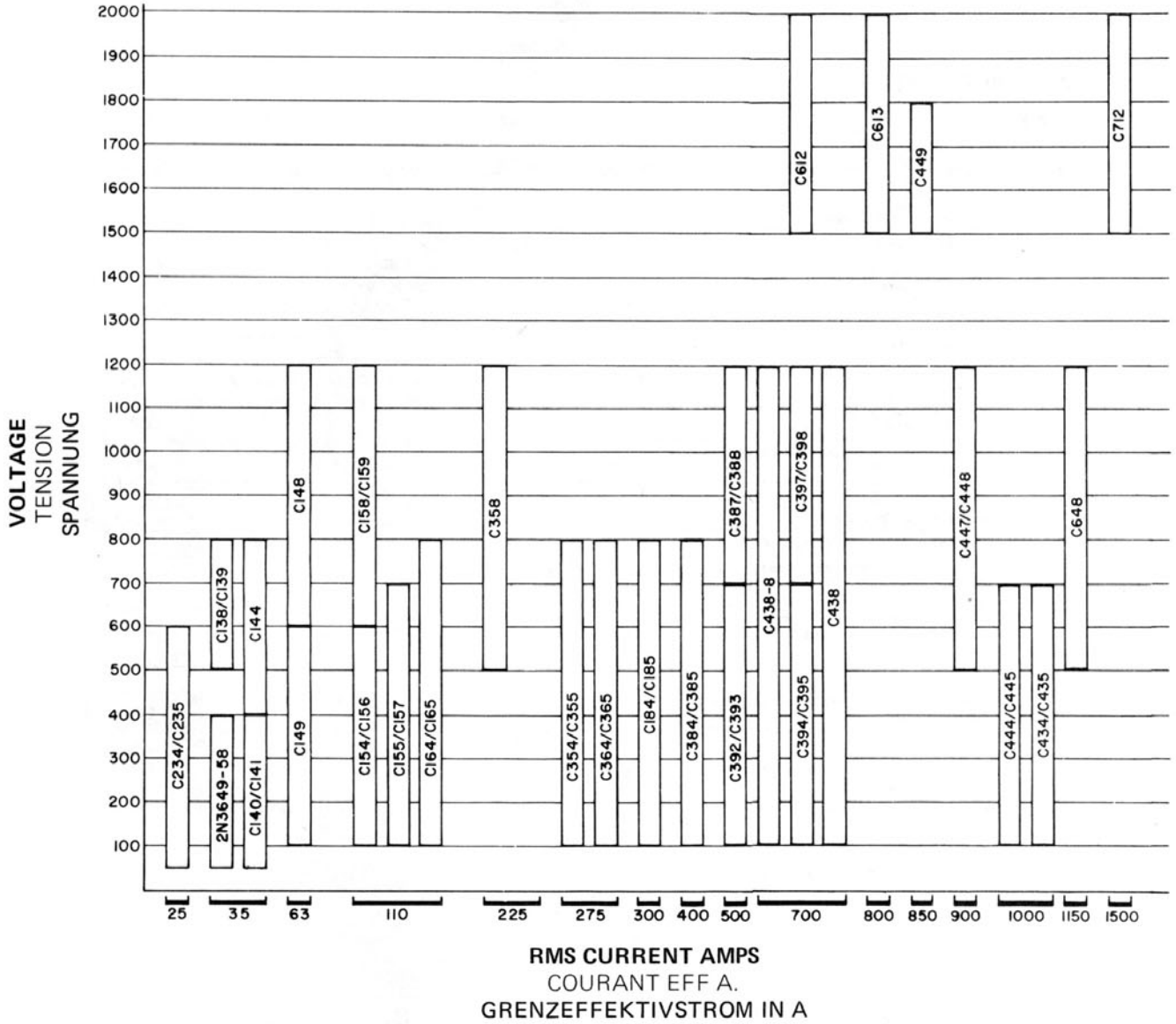

INVERTER SCR'S
THYRISTORS RAPIDES
FREQUENZ-THYRISTOREN

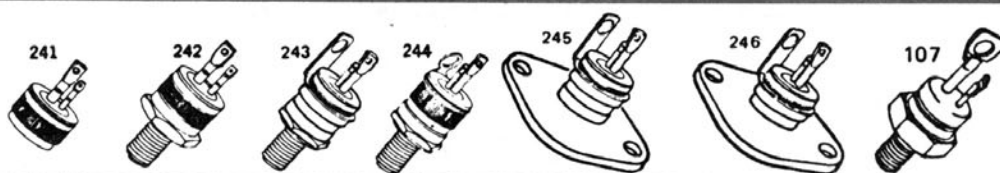

25 TO 35 AMPERES

GE TYPE	C234, C235	C138 ⁽¹⁾	C139	C140	C141	C144
JEDEC	-	-	-	2N3649-53	2N3654-58	-

ELECTRICAL SPECIFICATIONS

VOLTAGE RANGE	50-600	500-800	500-800	50-400	50-400	500-800
----------------------	--------	---------	---------	--------	--------	---------

FORWARD CONDUCTION

$I_{T(RMS)}$	Max. RMS on-state current @ $T_C = 65^\circ C$, 50% duty (A)	25	35	35	35	35	35
	1 KHz	25	26	26	26	26	35
	5 KHz	-	22	22	26	26	32
	10 KHz	-	18	18	20	20	30
I_{TSM}	Max. peak one cycle, non-repetitive surge current (A)	250	200	200	200	200	200
I^2t	Max. I^2t for fusing @ < 1.5 msec. (A ² Sec.)	220	165	165	165	165	165
$R_{\theta JC}$	Max. internal thermal resistance, dc, junction-to-case ($^\circ C/W$)	1.0	1.0	1.0	1.7	1.7	1.0
$t_d + t_r$	Typical turn-on time (μsec)	3.0	3.1	3.1	3.1	3.1	3.1
t_q	Max. turn-off time @ rated voltage and T_J (μsec)	20	-	-	-	-	-
	20V/ μsec reapplied @ 200V/ μsec reapplied	-	10	10	15	10	15
di/dt	Critical rate-of-rise of on-state current (A/ μsec)	40	100	100	400	400	100
T_J	Junction operating temperature range ($^\circ C$)	-40 to 100	-65 to 125	-65 to 125	-65 to 125	-65 to 125	-65 to 125

BLOCKING

dv/dt	Min. critical rate-of-rise of off-state voltage exponential to rated V_{DRM} @ Max. rated T_J (V/ μsec)	20	200	200	200	200	200
---------	---	----	-----	-----	-----	-----	-----

FIRING

I_{GT}	Max. required gate current to trigger (mA) @ $-65^\circ C$	-	500	500	500	500	450
	@ $-40^\circ C$	80	-	-	-	-	-
	@ $25^\circ C$	40	180	180	180	180	150
V_{GT}	Max. required voltage to trigger (V) @ $-65^\circ C$	-	4.5	4.5	4.5	4.5	4.0
	@ $-40^\circ C$	2.0	-	-	-	-	-
	@ $25^\circ C$	1.5	3.0	3.0	3.0	3.0	2.5
V_{GT}	Min. required voltage to trigger (V) @ $100^\circ C$	0.2	-	-	-	-	-
	@ $125^\circ C$	-	0.25	0.25	0.25	0.25	.03

VOLTAGE TYPES

Repetitive Peak Forward and Reverse Voltages						
50	C234F C235F			C140F 2N3649	C141F 2N3654	
100	C234A C235A			C140A 2N3650	C141A 2N3655	
200	C234B C235B			C140B 2N3651	C141B 2N3656	
300	C234C C235C			C140C 2N3652	C141C 2N3657	
400	C234D C235D			C140D 2N3653	C141D 2N3658	
500	C234E C235E	C138E10 C138E20	C139E10 C139E20			C144E15 C144E30
600	C234M C235M	C138M10 C138M20	C139M10 C139M20			C144M15 C144M30
700		C138S10 C138S20	C139S10 C139S20			C144S15 C144S30
800		C138N10 C138N20	C139N10 C139N20			C144N15 C144N30
PACKAGE OUTLINE NO.	241 (C235) 242, 3, 4, 5, & 6 (C234)	107	107	107	107	107

(1) $V_{RRM} = 50V$

INVERTER SCR'S THYRISTORS RAPIDES FREQUENZ-THYRISTOREN

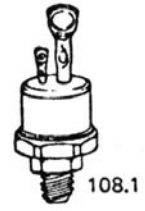
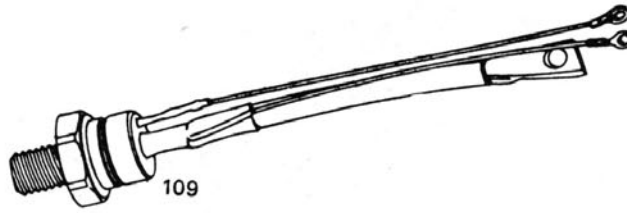

63 TO 270 AMPERES

GE TYPE	C48/C148	C49/C149	C154/C156	C155/C157	C158/C159	C164/C165	C354/C355	C358
CONSTRUCTION	ALL DIFFUSED	ALL DIFFUSED	AMPLIFYING GATE	AMPLIFYING GATE	AMPLIFYING GATE	AMPLIFYING GATE	AMPLIFYING GATE	AMPLIFYING GATE
ELECTRICAL SPECIFICATIONS								
VOLTAGE RANGE	600-1200	100-600	100-600	100-600	500-1200	600/800	100-600	500-1200
FORWARD CONDUCTION								
I_T(RMS) Max. forward conduction sinusoidal @ T _C = 65°C, 50% duty (A)								
@ 60 Hz	110/63	110/63	110	110	110	110	270	225
@ 600 Hz	110/63	110/63	110	110	110	110	250	225
@ 1200 Hz	110/63	110/63	110	110	110	110	225	225
@ 2500 Hz	70/63	110/63	80	80	100	110	150	175
@ 5000 Hz	55/63	65/63	—	110	90	110	—	100
I_{TSM} Max. peak one cycle, non-repetitive surge current (A)	700	1000	1800	1800	1600	1800	1800	1600
I_{2t} Max. I _{2t} for fusing for 8.3 msec. (A ² sec)	2000	4150	13,500	13,500	10,500	13,500	13,500	10,500
R_{θJC} Max. thermal impedance (°C)	.35	.35	.3	.3	.3	.3	.13	.135
t_d + t_r Typical turn-on time (μsec)	2	2	2	2	5	2.0	2	5
t_q Turn-off time @ rated voltage and T _J V _R = 50V min. (μsec)	30/40	10/20	10	20	30	—	10/20	30
@ 20V/μsec reapplied	—	—	—	—	40	—	—	40
@ 100V/μsec reapplied	—	—	—	—	35	—	—	35
@ 200V/μsec reapplied	—	—	—	—	40	10/20	—	40
di/dt Critical rate-of-rise of on-state current (A/μsec)	100	100	100	100	500	500	100	500
T_J Junction operating temperature range (°C)	← -40 to 125°C →							
BLOCKING								
dv/dt Critical rate-of-rise off-state voltage exponential to rated V _{DRM} @ Max. T (V/μsec)	200	200	200	100	200	200	200, 100	200
FIRING								
I_{GT} Max. required gate current to trigger (mA)	300	300	200	200	300	400	200	300
@ -40°C								
@ 125°C	125	125	120	120	125	175	120	125
V_{GT} Max. required voltage to trigger (V)	3.5	3.5	5	5	5	5	5	5
@ -40°C								
@ 125°C (Min.)	.25	.25	.15	.15	.15	.15	.25	.15
VOLTAGE TYPES								
Repetitive Peak Forward and Reverse Voltages								
100		C49A C149A	C154A C156A	C155A C157A		C164A C165A	C354A C355A	
150		C49G C149G	C154G C156G	C155G C157G			C354G C355G	
200		C49B C149B	C154B C156B	C155B C157B		C164B C165B	C354B C355B	
300		C49C C149C	C154C C156C	C155C C157C		C164C C165C	C354C C355C	
400		C49D C149D	C154D C156D	C155D C157D		C164D C165D	C354D C355D	
500		C49E C149E	C154E C156E	C155E C157E	C158E C159E	C164E C165E	C354E C355E	C358E
600	C48M C148M	C49M C149M	C154M C156M	C155M C157M	C158M C159M	C164M C165M	C354M C355M	C358M
700	C48S C148S				C158S C159S	C165S		C358S
800	C48N C148N				C158N C159N	C165N		C358N
900	C48T C148T				C158T C159T			C358T
1000	C48P C148P				C158P C159P			C358P
1100	C48PA C148PA				C158PA C159PA			C358PA
1200	C48PB C148PB				C158PB C159PB			C358PB
PACKAGE TYPE	½" / ¼" STUD	½" / ¼" STUD	½" STUD	½" STUD	½" STUD	½" STUD	½" PRESS PAK	½" PRESS PAK
PACKAGE OUTLINE NO.	109/108.1	109/108.1	109, 108	109, 108	109, 108	109	280	280

INVERTER SCR'S
THYRISTORS RAPIDES
FREQUENZ-THYRISTOREN

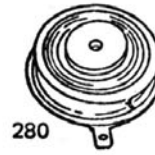
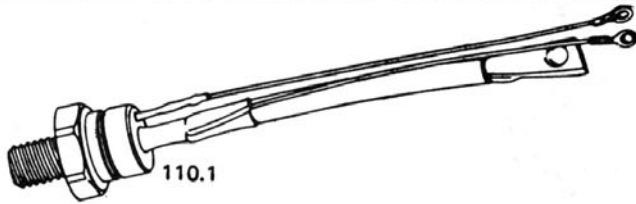

275 TO 400 AMPERES

GE TYPE	C184/C185	C364	C365	C384/C385
CONSTRUCTION	AMPLIFYING GATE	AMPLIFYING GATE	AMPLIFYING GATE	AMPLIFYING GATE
ELECTRICAL SPECIFICATIONS				
VOLTAGE RANGE	600/800	100-600	100-800	100-800
FORWARD CONDUCTION				
I_T (RMS)	Max. forward conduction sinusoidal @ $T_C = 65^\circ\text{C}$, 50% duty (A)			
@ 60 Hz	300	275	275	400
@ 600 Hz	250	275	275	300
@ 1200 Hz	190	270	270	275
@ 2500 Hz	—	200	200	—
@ 5000 Hz	—	140	140	—
I_{TSM}	Max. peak one cycle, non-repetitive surge current (A)			
	3500	1800	1800	3500
I_2t	Max. I_2t for fusing for 8.3 msec. (A ² sec)			
	50,000	13,500	13,500	50,000
$R_{\theta JC}$	Max. thermal impedance ($^\circ\text{C}/\text{W}$)			
	.15	.135	.135	.095
$t_d + t_r$	Typical turn-on time (μsec)			
	2	2	2	2
t_q	Turn-off time @ rated voltage and $T_J V_R = 50$ volts min. (μsec)			
@ 20V/ μsec reapplied				
@ 100V/ μsec reapplied				
@ 200V/ μsec reapplied	10-20	10	20	10-20
di/dt	Critical rate-of-rise of on-state current (A/ μsec)			
	800	800	800	800
T_J	Junction operating temperature range ($^\circ\text{C}$)			
	-40 to 125 $^\circ\text{C}$	-40 to 125 $^\circ\text{C}$	-40 to 125 $^\circ\text{C}$	-40 to 125 $^\circ\text{C}$
BLOCKING				
dv/dt	Min. critical rate-of-rise off-state voltage exponential to rated V_{DRM} @ Max. T_J (V/ μsec)			
	200	200	200	200
FIRING				
I_{GT}	Max. required gate current to trigger (mA)			
@ -40 $^\circ\text{C}$	500	400	400	500
@ 125 $^\circ\text{C}$	250	175	175	250
V_{GT}	Max. required voltage to trigger (V)			
@ -40 $^\circ\text{C}$	5	5	5	5
@ 125 $^\circ\text{C}$ (Min.)	.15	.15	.15	.15
VOLTAGE TYPES				
Repetitive Peak Forward and Reverse Voltages				
100	C184A/C185A	C364A	C365A	C384A/C385A
200	C184B/C185B	C364B	C365B	C384B/C385B
300	C184C/C185C	C364C	C365C	C384C/C385C
400	C184D/C185D	C364D	C365D	C384D/C385D
500	C184E/C185E	C364E	C365E	C384E/C385E
600	C184M/C185M	C364M	C365M	C384M/C385M
700	C185S		C365S	C385S
800	C185N		C365N	C385N
900				
1000				
1100				
1200				
PACKAGE TYPE	3/4" STUD	1/2" PRESS PAK	1/2" PRESS PAK	1/2" PRESS PAK
PACKAGE OUTLINE NO.	110.1	280	280	280

INVERTER SCR'S
THYRISTORS RAPIDES
FREQUENZ-THYRISTOREN

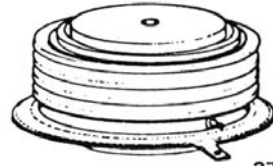

276

490 TO 650 AMPERES

GE TYPE	C387	C388	C397	C398	C392	C393
CONSTRUCTION	AMPLIFYING GATE	AMPLIFYING GATE	AMPLIFYING GATE	AMPLIFYING GATE	AMPLIFYING GATE	AMPLIFYING GATE
ELECTRICAL SPECIFICATIONS						
VOLTAGE RANGE	500-1200	500-1200	500-1200	500-1200	100-700	100-600
FORWARD CONDUCTION						
$I_{T(RMS)}$	Max. forward conduction sinusoidal @ $T_C = 65^\circ C$, 50% duty (A)					
	@ 60 Hz	490	490	650	650	490
	@ 600 Hz	440	440	610	610	440
	@ 1200 Hz	250	250	400	400	250
	@ 2500 Hz	175	175	250	250	110
	@ 5000 Hz	60	60	150	150	—
I_{TSM}	Max. peak one cycle, non-repetitive surge current (A)					
		5500	5500	7500	7500	5500
I_{2t}	Max. I_{2t} for fusing for 8.3 msec. ($A^2 \text{ sec}$)					
		120,000	120,000	230,000	230,000	100,000
$R_{\theta JC}$	Max. thermal impedance ($^\circ C/W$)					
		.06	.06	.06	.06	.06
$t_d + t_r$	Typical turn-on time (μsec)					
		2	2	2	2	2
t_q	Turn-off time @ rated voltage and $T_J V_R = 50 \text{ V min.}$ (μsec) @ $20V/\mu\text{sec}$ reapplied					
		30 Typ.	20 Typ.	40 Typ.	30 Typ.	10 Typ.
	@ $100V/\mu\text{sec}$ reapplied	35	25	50	35	12
	@ $200V/\mu\text{sec}$ reapplied	40	30	60	40	14
di/dt	Critical rate-of-rise of on-state current ($A/\mu\text{sec}$)					
		500	500	800	800	800
T_J	Junction operating temperature range ($^\circ C$)					
		-40 to +125 $^\circ C$	-40 to +125 $^\circ C$	-40 to +125 $^\circ C$	-40 to +125 $^\circ C$	-40 to +125 $^\circ C$
BLOCKING						
dv/dt	Min. critical rate-of-rise off-state voltage exponential to rated V_{DRM} @ Max. T_J ($V/\mu\text{sec}$)					
		200	200	200	200	200
FIRING						
I_{GT}	Max. required gate current to trigger (mA)					
	@ -40 $^\circ C$	300	300	300	300	400
	@ 125 $^\circ C$	125	125	125	125	150
V_{GT}	Max. required voltage to trigger (V)					
	@ -40 $^\circ C$	5	5	5	5	5
	@ 125 $^\circ C$ (Min.)	.15	.15	.15	.15	.15
VOLTAGE TYPES						
Repetitive Peak Forward and Reverse Voltages						
	100				C392A	C393A
	200				C392B	C393B
	300				C392C	C393C
	400				C392D	C393D
	500	C387E	C388E	C397E	C398E	C392E
	600	C387M	C388M	C397M	C398M	C392M
	700	C387S	C388S	C397S	C398S	C393M
	800	C387N	C388N	C397N	C398N	
	900	C387T	C388T	C397T	C398T	
	1000	C387P	C388P	C397P	C398P	
	1100	C387PA	C388PA	C397PA	C398PA	
	1200	C387PB	C388PB	C397PB	C398PB	
PACKAGE TYPE	1" PRESSPAK	1" PRESSPAK	1" PRESSPAK	1" PRESSPAK	1" PRESSPAK	1" PRESSPAK
PACKAGE OUTLINE NO.	276	276	276	276	276	276

INVERTER SCR'S
THYRISTORS RAPIDES
FREQUENZ-THYRISTOREN

575 TO 1000 AMPERES

GE TYPE	C394/C395	C434/C435	C438/C438-8	C444/C445	C447/C448
CONSTRUCTION	AMPLIFYING GATE	AMPLIFYING GATE	AMPLIFYING GATE	AMPLIFYING GATE	AMPLIFYING GATE
ELECTRICAL SPECIFICATIONS					
VOLTAGE RANGE	100-700	100-700	500-1200	100-700	500-1200
FORWARD CONDUCTION					
$I_{T(RMS)}$	Max. forward conduction sinusoidal @ $T_C = 65^\circ C$, 50% duty (A)				
@ 60 Hz	700	975	750/575	1000	900
@ 600 Hz	700	1050	585/400	1000	900
@ 1200 Hz	650	800	425/275	1000	900
@ 2500 Hz	450	500	200/150	1000	850
@ 5000 Hz	300	270	—	850	615
I_{TSM}	Max. peak one cycle, non-repetitive surge current (A)				
	8,000	8,000	7,500/5,500	12,000	10,000
I^2t	Max. I^2t for fusing for 8.3 msec. ($A^2 \text{ sec}$)				
	250,000	250,000	230,000/120,000	600,000	415,000
$R_{\theta JC}$	Max. thermal impedance ($^\circ C/W$)				
	.06	.04	.04	.04	.04
$t_d + t_r$	Typical turn-on time (μsec)				
	2.0	2.0	2.0	2.0	2.0
t_q	Turn-off time @ rated voltage and T_J $V_R = 50 \text{ V min.}$ (μsec) @ $20 \text{ V}/\mu\text{sec}$ reapplied				
	10/15 Typical	10/15	30/20	—	—
	@ $200 \text{ V}/\mu\text{sec}$ reapplied	14	14/20	40/30	10/20
	@ $400 \text{ V}/\mu\text{sec}$ reapplied	—	—	—	15
					40/25
di/dt	Critical rate-of-rise of on-state current ($A/\mu\text{sec}$)				
	800	500	500	800	800
T_J	Junction operating temperature range ($^\circ C$)				
	-40 to $125^\circ C$	-40 to $125^\circ C$	-40 to $125^\circ C$	-40 to $125^\circ C$	-40 to $125^\circ C$
BLOCKING					
dv/dt	Min. critical rate-of-rise of off-state voltage, exponential to rated V_{DRM} @ Max. T_J ($V/\mu\text{sec}$)				
	200	200	200	200	400
FIRING					
I_{GT}	Max. required gate current to trigger (mA) @ $-40^\circ C$				
	400	400	400	400	400
	@ $125^\circ C$	150	150	150	150
V_{GT}	Max. required voltage to trigger (V) @ $-40^\circ C$				
	5	5	5	5	5
	@ $125^\circ C$ (Min.)	.15	.15	.15	.25
				.25	.25
VOLTAGE TYPES					
Repetitive Peak Forward and Reverse Voltages					
100	C394/C395A	C434/C435A		C444/C445A	
200	C394/C395B	C434/C435B		C444/C445B	
300	C394/C395C	C434/C435C		C444/C445C	
400	C395/C395D	C434/C435D		C444/C445D	
500	C394/C395E	C434/C435E	C438/C438E8	C444/C445E	C447/C448E
600	C394/C395M	C434/C435M	C438/C438M8	C444/C445M	C447/C448M
700	C394/C395S	C434/C435S	C438/C438S8	C444/C445S	C447/C448S
800			C438/C438N8		C447/C448N
900			C438/C438T8		C447/C448T
1000			C438/C438P8		C447/C448P
1100			C438/C438PA8		C447/C448PA
1200			C438/C438PB8		C447/C448PB
1300					
1400					
1500					
1600					
1700					
1800					
PACKAGE TYPE	1" PRESS PAK	½" PRESS PAK	½" PRESS PAK	1" PRESS PAK	1" PRESS PAK
PACKAGE OUTLINE NO.	276	276	276	276	276

INVERTER SCR'S
THYRISTORS RAPIDES
FREQUENZ-THYRISTOREN

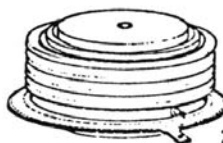

276
277



276.1

800 TO 1500 AMPERES

GE TYPE	C648	C612	C613	C712	
CONSTRUCTION	AMPLIFYING GATE	AMPLIFYING GATE	AMPLIFYING GATE	AMPLIFYING GATE	
ELECTRICAL SPECIFICATIONS					
VOLTAGE RANGE	500-1200	1500-1800	1500-2000	1500-2000	
FORWARD CONDUCTION					
$I_{T(RMS)}$	Max. forward conduction sinusoidal @ $T_C = 65^\circ C$, 50% duty (A)				
	@ 60 Hz	1150	1000	800	1500
	@ 600 Hz	1150	1000	800	1500
	@ 1200 Hz	1150	1000	800	1500
	@ 2500 Hz	1100	1000	750	1500
@ 5000 Hz	950	—	675	1100	
I_{TSM}	Max. peak one cycle, non-repetitive surge current (A)	10,000	9000	6500	20,000
I^2t	Max. I^2t for fusing for 8.3 msec. ($A^2 \text{ sec}$)	415,000	310,000	170,000	1,660,000
$R_{\theta JC}$	Max. thermal impedance ($^\circ C/W$)	.04	.04	.04	.023
$t_d + t_r$	Typical turn-on time (μsec)	2.5	2.0	—	—
t_q	Turn-off time @ rated voltage and T_J $V_R = 50V$ min. (μsec) @ 20V/ μsec	—	—	—	—
	@ 200V/ μsec reapplied	—	—	40	50
	@ 400V/ μsec reapplied	40	60	40	—
di/dt	Critical rate-of-rise of on-state current ($A/\mu\text{sec}$)	800	500	500	800
T_J	Junction operating temperature range ($^\circ C$)	-40 to 125 $^\circ C$	-40 to 125 $^\circ C$	-40 to 125 $^\circ C$	-40 to 125 $^\circ C$
BLOCKING					
dv/dt	Min. critical rate-of-rise of off-state voltage exponential to rated V_{DRM} @ Max. T_J ($V/\mu\text{sec}$)	400	200	400	500
FIRING					
I_{GT}	Max. required gate current to trigger (mA) @ -40 $^\circ C$	350	200	200	200
	@ 125 $^\circ C$	100	125	30	30
V_{GT}	Max. required voltage to trigger (V) @ -40 $^\circ C$	5	5	5	5
	@ 125 $^\circ C$ (Min.)	.15	.3	.3	.3
VOLTAGE TYPES					
Repetitive Peak Forward and Reverse Voltages					
100	—	—	—	—	
200	—	—	—	—	
300	—	—	—	—	
400	—	—	—	—	
500	C648E	—	—	—	
600	C648M	—	—	—	
700	C648S	—	—	—	
800	C648N	—	—	—	
900	C648T	—	—	—	
1000	C648P	—	—	—	
1100	C648PA	—	—	—	
1200	C648PB	—	—	—	
1300	—	—	—	—	
1400	—	—	—	—	
1500	—	C612PE	C613PE	C712PE	
1600	—	C612PM	C613PM	C712PM	
1700	—	C612PS	C613PS	C712PS	
1800	—	C612PN	C613PN	C712PN	
1900	—	—	C613PT	C712PT	
2000	—	—	C613L	C712L	
PACKAGE TYPE	1" PRESS PAK	1" PRESS PAK	1" PRESS PAK	1" PRESS PAK	
PACKAGE OUTLINE NO.	276	277	277	276.1	

HEAT EXCHANGER MODULES FOR HIGH CURRENT RECTIFIERS & SCR'S
ASSEMBLAGES A REFROIDISSEMENT PAR EAU POUR THYRISTORS ET DIODES DE PUISSANCE
WÄRMEAUSTAUSCHER FÜR HOCHLEISTUNGSGLEICHRICHTER UND -THYRISTOREN

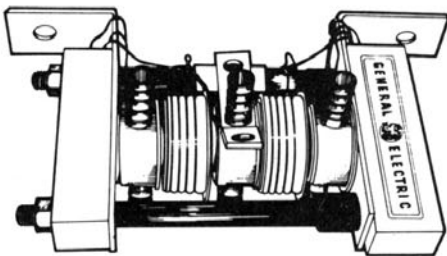

G6/G14/G15

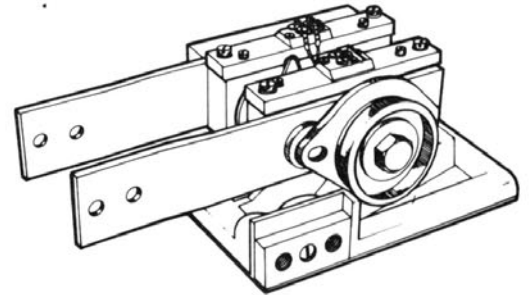

G9/G10/3N221/3N222

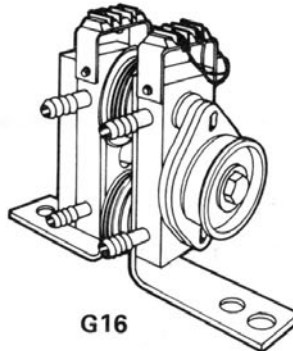

G16

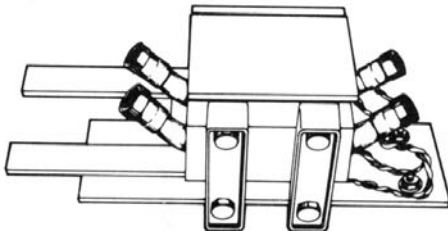

G11

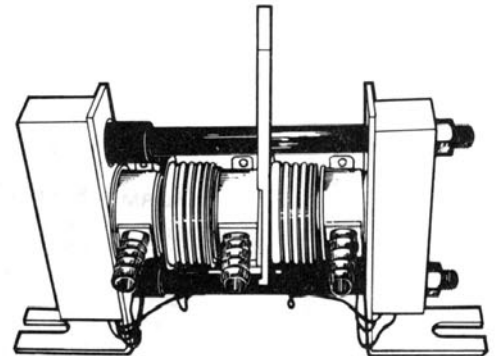

G18

CELL DATA			180° CONDUCTION, LIQUID COOLED AT 40°C			
CELL NO.	MAX. VOLTS PER CELL	SINGLE SURGE AMPS	AVERAGE CURRENT PER CELL			RMS CURRENT FOR SWITCH
			G6/G14/G15 (1 GPM)	G11 (1 GPM)	G18 (2 GPM)	G9/G10/3N221/3N222/G16 (1 GPM)
A390	1500	7,000	600	—	—	—
A430	1500	10,000	1100	—	—	—
A540	2400	12,000	1150	—	—	—
A570	600	18,000	1500	—	—	—
C350	1300	1,600	190	190	—	—
C380	1300	3,500	260	260	—	—
C390	1300	8,000	500	—	—	—
C391	1800	8,000	450	—	—	—
C398	1200	7,500	450	—	—	—
C440	1300	13,000	760	—	840	—
C441	1800	11,000	640	—	700	—
C444/5	600	12,000	—	—	540*	—
C447/8	1200	10,000	—	—	445*	—
C450	1300	28,500	—	—	1470	—
C451	1800	20,000	—	—	1140	—
C458	1400	18,700	—	—	1110*	—
C501	1700	8,000	550	—	—	1500
C502	2000	8,000	475	—	—	—
C602	2600	10,000	525	—	590	1600
C613	2000	6,500	—	—	510*	—
C648	1200	10,000	—	—	680*	—
C701	2000	18,000	—	—	—	3000
C702	2400	16,000	—	—	900	2500
C712	2000	18,000	—	—	950*	—

*1 KHz, 50% Duty Cycle.

TRIACS
TRIACS
TRIACS

V_{DRM}	REPETITIVE PEAK OFF-STATE VOLTAGE TENSION DE CRETE A L'ETAT BLOQUE PERIODISCHE SPITZEN-SPERRSPANNUNG
I_{DRM}	MAXIMUM LEAKAGE CURRENT AT T_C = 25°C COURANT DE FUITE A 25°C MAX. LECKSTROM BEI T _C = 25°C
I_L	MAXIMUM DC LATCHING CURRENT COURANT D'ACC ROCHAGE MAX. EINRAST-STROM
T_C	MAXIMUM CASE TEMPERATURE AT RATED RMS CURRENT TEMPERATURE DE BOITIER AU COURANT NOMINAL MAX. GEHÄUSETEMPERATUR BEI GRENZEFFEKTIVSTROM

TRIAC SELECTOR GUIDE
GUIDE DE SELECTION DES TRIACS
AUSWAHLTABELLE FÜR TRIAC

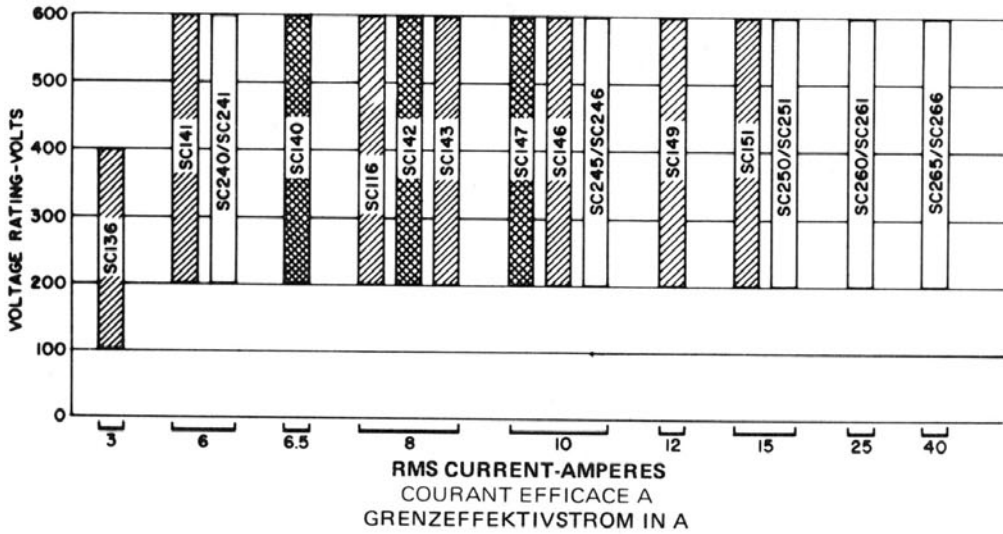

ALL WITH GLASS PASSIVATION
 TOUTES LES PASTILLES SONT PASSIVEES AU VERRE
 ALLE TYPEN MIT POWER-GLAS-PASSIVIERUNG

- ISOLATED PLASTIC**
 PLASTIQUE ISOLE
 PLASTIK-ISOLIERTE AUSFÜHRUNG
- NON-ISOLATED PLASTIC**
 PLASTIQUE NON ISOLE
 PLASTIK-UNISOLIERTE AUSFÜHRUNG
- HERMETIC METAL**
 METALLIQUES
 HERMETISCHES METALLEGEHÄUSE

TRIAC TRIGGERS
CIRCUITS INTEGRES DE DECLENCHEMENT DES TRIACS
TRIGGER FÜR TRIACS

THE ST2 (DIAC) IS A SILICON BI-DIRECTIONAL DIODE WHICH MAY BE USED FOR TRIGGERING TRIACS OR SCR'S. IT HAS A THREE-LAYER STRUCTURE WITH NEGATIVE RESISTANCE SWITCHING CHARACTERISTICS IN BOTH DIRECTIONS.

THE ST4 IS AN ASYMMETRICAL AC TRIGGER INTEGRATED CIRCUIT FOR USE IN TRIAC PHASE CONTROL APPLICATIONS. THIS DEVICE REDUCES THE SNAP-ON EFFECTS THAT ARE PRESENT IN CONVENTIONAL TRIGGER CIRCUITS BY ELIMINATING CONTROL CIRCUIT HYSTERESIS. THIS PERFORMANCE IS POSSIBLE WITH A SINGLE RC TIME CONSTANT WHERE AS A SYMMETRICAL CIRCUIT OF COMPARABLE PERFORMANCE WOULD REQUIRE AT LEAST THREE MORE PASSIVE COMPONENTS.

LE ST2 EST UNE DIODE BI-DIRECTIONNELLE AU SILICIUM QUI PEUT ETRE UTILISEE POUR LE DECLENCHEMENT DE TRIACS OU DE THYRISTORS. CE COMPOSANT EST CONSTITUE PAR UNE STRUCTURE A 3 COUCHES ET A LA PARTICULARITE DE COMMUTER DANS LES 2 SENS AVEC UNE RESISTANCE NEGATIVE.

LE ST4 EST UN DISPOSITIF DE DECLENCHEMENT ASYMETRIQUE DESTINE AUX CIRCUITS DE CONTROLE DE PHASE A TRIAC. L'ELIMINATION DE L'EFFET HYSTERESIS (SNAP-ON) A L'AMORÇAGE DU TRIAC EST SA PARTICULARITE.

DER DIAC ST2 IST EINE BIDIREKTIONALE SI-DIODE ZUM TRIGGERN VON TRIACS UND THYRISTOREN. ER IST EINE DREISCHICHT-DIODE MIT NEGATIVER WIDERSTANDS-SCHALTCHARAKTERISTIK IN BEIDEN RICHTUNGEN.

DER ST4 IST EIN ASYMMETRISCHER TRIGGER FÜR TRIACS IN PHASENSCHNITT-STEUERUNGEN. DURCH VERMINDERUNG DER SCHALTHYSTERESE REDUZIERT ER DEN BEI KONVENTIONELLEN ZUNDSCHALTUNGEN ZU BEOBACHTENDEN SPRUNGEFFEKT.

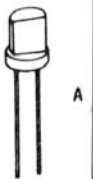

A



B

GE Type	V _{S2} Switching Voltage		V _{S1} Switching Voltage		I _{S2} , I _{S1} Switching Current Max. (μA)	Pulse Output Min. (V)	Package Outline No.
	Min. (V)	Max. (V)	Min. (V)	Max. (V)			
ST2	28 ¹	36 ¹	28 ¹	36 ¹	200	3.0	B
ST4	7	9	14	18	80	3.5	A

¹ For ST2, V_{S2} = V_{S1} ± 10%

**TRIACS – ENCAPSULATED PACKAGE
POWER GLAS PASSIVATED PELLETS**

TRIACS – BOITIERS PLASTIQUES
PASTILLES PASSIVEES AU VERRE

TRIACS – GEKAPSELTES PLASTIKGEHÄUSE
POWER GLAS – PASSIVIERTE CHIPS

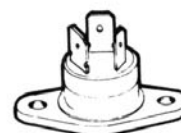
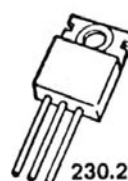
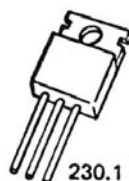
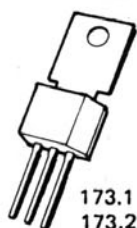

316

ISOLATED
WITH QUICK
DISCONNECT
TERMINALS

GE TYPE	POWER TAB™		ISOLATED POWER PACT™			NON-ISOLATED POWER PACT™						
	SC136	SC116	SC140	SC142	SC147	SC141	SC143	SC146	SC149	SC151	SC160	
ELECTRICAL SPECIFICATIONS												
VOLTAGE CHARACTERISTICS												
V_{DRM}	Repetitive Peak Off-State Voltage @ $T_C = -40^\circ\text{C}$ to $+100^\circ\text{C}$											
	100 V	SC136A	—	—	—	—	—	—	—	—	—	
	200 V	SC136B	SC116B	SC140B	SC142B	SC147B	SC141B	SC143B	SC146B	SC149B	SC151B	SC160B
	400 V	SC136D	SC116D	SC140D	SC142D	SC147D	SC141D	SC143D	SC146D	SC149D	SC151D	SC160D
	500 V	—	SC116E	SC140E	SC142E	SC147E	SC141E	SC142E	SC146E	SC149E	SC151E	SC160E
600 V	—	SC116M	SC140M	SC142M	SC147M	SC141M	SC142M	SC146M	SC149M	SC151M	SC160M	
V_{TM}	Max. On-State Voltage at Peak of RMS Current Rating (V)	1.8	1.63	1.85	1.75	1.50	1.83	1.55	1.65	1.65	1.52	1.58
CURRENT CHARACTERISTICS												
$I_{T(RMS)}$	Max. RMS On-State Current (A)	3	8	6.5	8	10	6	8	10	12	15	25
$T_{C(MAX)}$	Max. Case Temperature at Rated RMS Current ($^\circ\text{C}$)	65	32	80	75	80	80	80	80	75	80	65
I_{TSM}	Max. Peak One Cycle Non-Repetitive Surge Current (A):											
	@ 50 Hz	—	90	74	104	104	74	110	110	110	110	230
	@ 60 Hz	30	100	80	110	110	80	120	120	120	120	250
I_{DRM}	Max. Leakage Current at $T_C = 25^\circ\text{C}$ (mA)	.01	0.1	0.1	0.1	0.1	0.1	0.1	0.1	0.1	0.1	0.2
I_H	Max. DC Holding Current (mA _{dc})											
	@ $+25^\circ\text{C}$	50	50	50	50	50	50	50	50	50	50	75
	@ -40°C	100	100	100	100	100	100	100	100	100	100	150
I_L	Max. DC Latching Current (mA _{dc})											
	@ $T_C = +25^\circ\text{C}$											
	MT2 + Gate +	50	100	100	100	100	100	100	100	100	100	100
	MT2 - Gate -	50	100	100	100	100	100	100	100	100	100	100
	MT2 + Gate -	100	200	200	200	200	200	200	200	200	200	200
	@ $T_C = -40^\circ\text{C}$											
MT2 + Gate +	100	200	200	200	200	200	200	200	200	200	200	
MT2 - Gate -	100	200	400	400	400	400	400	400	400	400	400	
MT2 + Gate -	200	400	400	400	400	400	400	400	400	400	400	
BLOCKING												
dv/dt	Typical Static dv/dt at Rated V_{DRM} , Gate Open Circuited (V/ μsec)											
	@ $T_C = 100^\circ\text{C}$	—	150	100	150	150	100	150	150	200	200	—
	@ $T_C = 110^\circ\text{C}$	50	—	—	—	—	—	—	—	—	—	150@115 $^\circ\text{C}$
dv/dt _(c)	Min. Commutating dv/dt at Rated V_{DRM} and di/dt = (0.54) $I_{T(RMS)}$ A/msec. Gate Open Circuited, (V/ μsec).	5	4	4	4	4	4	4	4	4	4	5
TRIGGERING												
I_{GT}	Max. Required DC Gate Current (mA _{dc}) to Trigger, @ $V_D = 12\text{Vdc}$											
	@ $T_C = +25^\circ\text{C}$											
	MT2 + Gate +	25	50	50	50	50	50	50	50	50	50	50
	MT2 - Gate -	25	50	50	50	50	50	50	50	50	50	50
	MT2 + Gate -	25	80	50	50	50	50	50	50	50	50	50
	@ $T_C = -40^\circ\text{C}$											
MT2 + Gate +	50	80	80	80	80	80	80	80	80	80	80	
MT2 - Gate -	50	80	80	80	80	80	80	80	80	80	80	
MT2 + Gate -	50	130	80	80	80	80	80	80	80	80	80	
V_{GT}	Max. Required DC Gate Voltage to Trigger, MT2+ Gate+, MT2- Gate-, MT2+ Gate-. @ $V_D = 12\text{Vdc}$, (V).											
	@ $T_C = +25^\circ\text{C}$	2.0	2.5	2.5	2.5	2.5	2.5	2.5	2.5	2.5	2.5	2.5
	@ $T_C = -40^\circ\text{C}$	3.0	3.5	3.5	3.5	3.5	3.5	3.5	3.5	3.5	3.5	3.5
MECHANICAL SPECIFICATIONS												
PACKAGE OUTLINE NO.												
Non-Isolated Tab		173.1	173.2	—	—	—	230.2	230.2	230.2	230.2	230.2	—
Isolated Tab		—	—	230.1	230.1	230.1	—	—	—	—	—	316

**TRIACS – HERMETIC PACKAGES
POWER GLAS PASSIVATED PELLETS**

TRIACS – BOITIERS METALLIQUES
PASTILLES PASSIVEES AU VERRE

TRIACS – HERMETISCHES METALLGEHÄUSE
POWER-GLAS-PASSIVIERTE CHIPS

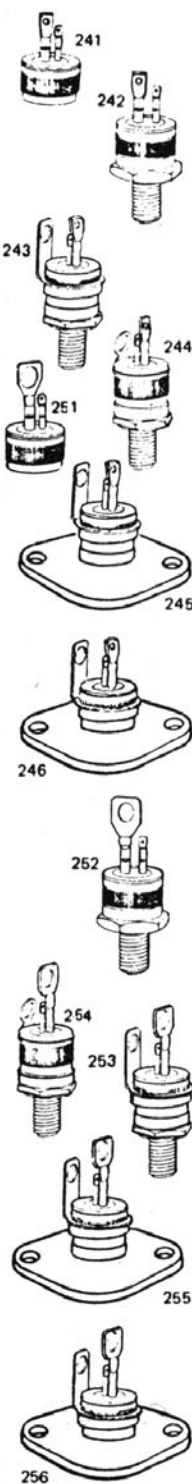

GE TYPE	STUD/TO-3 FLANGE	SC240	SC245	SC250	SC260	SC265
	PRESS-FIT	SC241	SC246	SC251	SC261	SC266
ELECTRICAL SPECIFICATIONS						
VOLTAGE CHARACTERISTICS						
V_{DRM}	Repetitive Peak Off-State Voltage @ $T_C = -40^\circ C$ to $+100^\circ C$					
	200 V	SC240/1B	SC245/6B	SC250/1B	SC260/1B	SC265/6B
	400 V	SC240/1D	SC245/6D	SC250/1D	SC260/1D	SC265/6D
	500 V	SC240/1E	SC245/6E	SC250/1E	SC260/1E	SC265/6E
	600 V	SC240/1M	SC245/6M	SC250/1M	SC260/1M	SC265/6M
V_{TM}	Max. On-State Voltage at Peak of RMS Current Rating (V)	1.83	1.65	1.65	1.58	1.38
CURRENT CHARACTERISTICS						
$I_{T(RMS)}$	Max. RMS On-State Current (A)	6	10	15	25	40
$T_{C(MAX)}$	Max. Case Temperature at Rated RMS Current ($^\circ C$) for Non-Isolated Stud/Press-Fit	82	80	86	80	81
	Isolated Stud/Non-Isolated TO-3 Flange	80	78	83	75	74
	Isolated TO-3 Flange	79	76	80	71	68
I_{TSM}	Max. Peak One Cycle Non-Repetitive Surge Current (A) @ 50 Hz	74	90	90	230	275
	@ 60 Hz	80	100	100	250	300
I_{DRM}	Max. Leakage Current at $T_C = 25^\circ C$ (mA)	0.1	0.1	0.1	0.2	0.2
I_H	Max. DC Holding Current (mAdc) @ $T_C = +25^\circ C$	50	50	50	75	75
	@ $T_C = -40^\circ C$	100	100	100	150	150
I_L	Max. DC Latching Current (mAdc) @ $T_C = +25^\circ C$ MT2+ Gate+	100	100	100	100	100
	MT2- Gate-	100	100	100	100	100
	MT2+ Gate-	200	200	200	200	200
	@ $T_C = -40^\circ C$ MT2+ Gate+	200	200	200	200	200
	MT2- Gate-	200	200	200	200	200
	MT2+ Gate-	400	400	400	400	400
BLOCKING						
dv/dt	Typical Static dv/dt at Rated V_{DRM} Gate Open Circuited (V/ μ sec)	100	150	250	150	150
dv/dt _(c)	Min. Commutating dv/dt at Rated V_{DRM} and di/dt = (0.54) $I_{T(RMS)}$ A/ μ sec, Gate Open Circuited (V/ μ sec)	4	4	4	5	5
TRIGGERING						
I_{GT}	Max. Required DC Gate Current to Trigger, MT2+ Gate+, MT2- Gate-, MT2+ Gate-, @ $V_D = 12 V_{dc}$ (mAdc)					
	@ $T_C = +25^\circ C$	50	50	50	50	80
	@ $T_C = -40^\circ C$	80	80	80	80	120
V_{GT}	Max. Required DC Gate Voltage to Trigger, MT2+ Gate+, MT2- Gate- MT2+ Gate-, @ $V_D = 12 V_{dc}$					
	@ $T_C = +25^\circ C$	2.5	2.5	2.5	2.5	2.5
	@ $T_C = -40^\circ C$	3.5	3.5	3.5	3.5	3.5
MECHANICAL SPECIFICATIONS						
PACKAGE OUTLINE NUMBER		241 (SC241) 242, 3, 4, 5, & 6 (SC240)	241 (SC241) 242, 3, 4, 5, & 6 (SC240)	241 (SC241) 242, 3, 4, 5, & 6 (SC240)	251 (SC261) 252, 3, 4, 5 & 6 (SC260)	251 (SC261) 252, 3, 4, 5 & 6 (SC260)

GE-MOV® GLOSSARY
GLOSSAIRE GE-MOV®
VARISTOR-BEZEICHNUNGEN

V_{ACM}	MAXIMUM APPLIED VOLTAGE:	AC RMS D.C.
	TENSION MAXIMALE APPLIQUEE:	TENSION ALTERNATIVE, VOLTS EFFICACE TENSION CONTINUE
	MAX.; BETRIEBSSPANNUNG:	WECHSELSPANNUNGS-EFFEKTIVWERT GLEICHSPANNUNG
W_{TM}	MAXIMUM ENERGY (JOULES)	
	ENERGIE MAXIMALE (JOULES)	
	MAX. ENERGIE-AUFNAHME (JOULE)	
I_{TM}	MAXIMUM NON-REPETITIVE PEAK PULSE CURRENT ($t_p \leq 6\mu s$)	
	AMPLITUDE MAXIMALE NON-REPETITIVE DE L'IMPULSION DE COURANT ($t_p \leq 6\mu s$)	
	MAX. NICHTPERIODISCHER SPITZEN-STOSS-STROM ($t_p \leq 6\mu s$)	
P_{TAM}	MAXIMUM AVERAGE POWER DISSIPATION	
	PUISSANCE MOYENNE ADMISE (WATTS)	
	MAX. VERLUSTLEISTUNG	
V_X	MAXIMUM VARISTOR VOLTAGE AT:	10 AMPS PEAK 1 AMP PEAK
	TENSION MAXIMALE DE LA VARISTANCE:	10 AMPERES 1 AMPERE
	MAX. VARISTORSPANNUNG BEI:	10A 1A

® REGISTERED TRADEMARK GENERAL ELECTRIC CO.

**FROM GENERAL ELECTRIC
NEW TRANSIENT PROTECTION MANUAL**

VOICI LE NOUVEAU MANUEL SUR LA PROTECTION
DES CIRCUITS CONTRE LES TRANSITOIRES

DAS NEUE HANDBUCH UBER TRANSIENTEN -
SCHUTZ VON GENERAL ELECTRIC

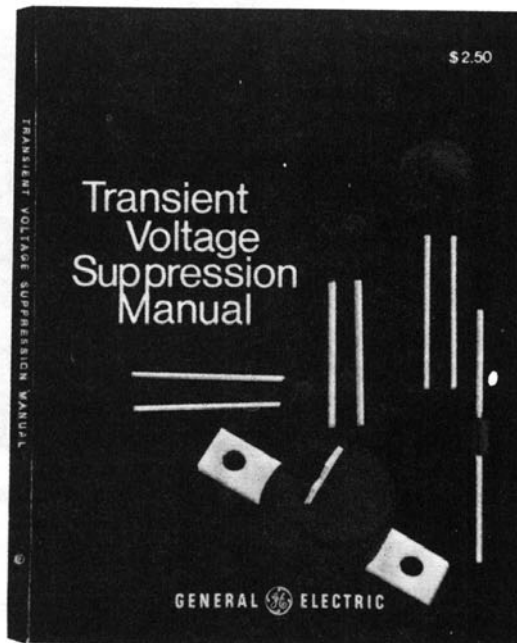

NEW MANUAL COMBINES, IN ONE PUBLICATION THEORY, KNOWLEDGE AND EXPERIENCE RELATING TO TRANSIENT CAUSE, DETECTION AND PROTECTION ACCUMULATED BY GENERAL ELECTRIC SCIENTISTS AND ENGINEERS... INCLUDES A COMPREHENSIVE SELECTION GUIDE AND PRODUCT SPECIFICATION SHEETS FOR DETERMINING THE OPTIMUM GE-MOV® VARISTOR.

COPIES ARE AVAILABLE FROM OEM SALES OFFICES AND DISTRIBUTORS LISTED ON THE INSIDE BACK COVER.

LE NOUVEAU MANUEL EXPOSE EN UNE SEULE PUBLICATION LA THEORIE, ET LES CONNAISSANCES ACQUISES PAR LES INGENIEURS DE GENERAL ELECTRIC DANS LE DOMAINE DES TRANSITOIRES. UN GUIDE DE SELECTION ET DES NOTES D'APPLICATIONS PERMETTENT UNE BONNE OPTIMISATION DES SOLUTIONS CHOISIES.

CE MANUEL EST A VOTRE DISPOSITION AUPRES DES BUREAUX DE VENTE ET DES DISTRIBUTEURS CITES A LA FIN DE CE CATALOGUE.

DIESES NEUE HANDBUCH (IN ENGL. SPRACHE) VERBINDET IN EINEM BAND DIE THEORETISCHEN GRUNDLAGEN, VIEL WISSENSWERTES UND ERFAHRUNGSWERTE ÜBER ENTSTEHUNG, ERKENNUNG UND VERMEIDUNG VON SCHÄDLICHEN SPANNUNGSPITZEN, ZUSAMMENGESTELLT VON GENERAL ELECTRIC - WISSENSCHAFTLERN UND TECHNIKERN. ES ENTHÄLT FERNER EINE ÜBERSICHTSTABELLE UND HINWEISE FÜR DIE AUSWAHL DES RICHTIGEN GE-MOV® VARISTORS.

SIE KÖNNEN IHR EXEMPLAR VON JEDER GENERAL ELECTRIC. NIEDERLASSUNG ODER VON JEDEM GENERAL ELECTRIC - DISTRIBUTOR ANFORDERN (S. HINTERE UMSCHLAGESEITE INNEN).

GE-MOV™ VARISTORS

GENERAL ELECTRIC ZINC OXIDE VARISTORS ARE VOLTAGE DEPENDENT, SYMMETRICAL RESISTORS WHICH PERFORM IN A MANNER SIMILAR TO BACK-TO-BACK ZENER DIODES IN CIRCUIT PROTECTIVE FUNCTIONS AND OFFER ADVANTAGES IN PERFORMANCE AND ECONOMICS. WHEN EXPOSED TO HIGH ENERGY VOLTAGE TRANSIENTS, THE VARISTOR IMPEDANCE CHANGES FROM A VERY HIGH STANDBY VALUE TO A VERY LOW CONDUCTING VALUE THUS CLAMPING THE TRANSIENT VOLTAGE TO A SAFE LEVEL. THE DANGEROUS ENERGY OF THE INCOMING HIGH VOLTAGE PULSE IS ABSORBED BY THE GE-MOV® VARISTOR, THUS PROTECTING VOLTAGE SENSITIVE CIRCUIT COMPONENTS.

LES VARISTANCES A OXYDE DE ZINC FABRIQUEES PAR GENERAL ELECTRIC ONT UNE CARACTERISTIQUE V-I SIMILAIRE A CELLE PRESENTEE PAR LES DIODES ZENER MONTEES EN OPPOSITION ET QUE L'ON TROUVE DANS CERTAINS CIRCUITS DE PROTECTION. CEPENDANT LES VARISTANCES GENERAL ELECTRIC SONT BEAUCOUP PLUS ECONOMIQUES ET PERFORMANTES. EN EFFET, EN PRESENCE D'UN TRANSITOIRE, L'IMPEDANCE DE LA VARISTANCE PASSE D'UNE TRES FORTE VALEUR A UNE VALEUR TRES FAIBLE CE QUI PERMET AINSI UN ECURETAGE EFFICACE DU TRANSISTOIRE. L'ENERGIE REPRESENTEE PAR CE TRANSITOIRE EST ENTIEREMENT ABSORBEE PAR LA VARISTANCE PROTEGEANT AINSI LES COMPOSANTS ENVIRONNANTS.

GENERAL ELECTRIC-ZINKOXYD-VARISTOREN SIND SPANNUNGSABHÄNGIGE, SYMMETRISCHE WIDERSTÄNDE, DIE ÄHNLICHE EIGENSCHAFTEN AUFWEISEN WIE IN ANTISERIE GESCHALTETE ZENERDIODEN UND DIE DAHER ZUM SCHUTZ VON SCHALTKREISEN DIENEN. BEIM AUFTRETEN ENERGIEREICHER SPANNUNGSSPITZEN VERÄNDERT DER VARISTOR SEINEN BISHERIGEN HOHEN WIDERSTANDSWERT UND GEHT IN DEN LEITENDEN ZUSTAND ÜBER, BIS DIE SPANNUNGSSPITZE AUF EINEN GEFÄHRLOSEN WERT ABGESUNKEN IST. DIE GEFÄHRLICHE ENERGIE DER ANKOMMENDEN SPANNUNGSPULSE WIRD VON DEN GE-MOV'S ABSORBIERT, WODURCH SPANNUNGSEMPFINDLICHE BAUELEMENTE VOR ZERSTÖRUNG GESCHÜTZT WERDEN.

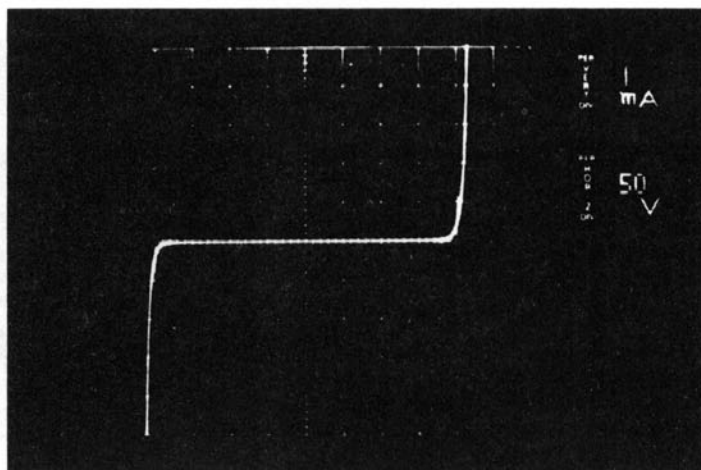

I-V Oscillograph (Actual Photo)

SELECTOR GUIDE
GUIDE DE SELECTION
AUSWAHL DES GEEIGNETEN GE-MOV® TYP.

1. **DETERMINE MAXIMUM (STEADY-STATE) VOLTAGE APPEARING ACROSS THE VARISTOR WHEN NO TRANSIENTS ARE PRESENT. INCLUDE ANY HIGH LINE CONDITIONS THAT MAY OCCUR. FOR EXAMPLE: 117 V_{RMS} - 10% HIGH LINE = 129 V_{RMS}. LOCATE VOLTAGE ON HORIZONTAL SCALE. DROP DOWN TO APPROPRIATE GE-MOV® VARISTOR SERIES (I.E., MA, L AND PA SERIES).**
 2. **LOCATE LEVEL OF ENERGY TRANSIENT ON THE LEFT-MOST VERTICAL SCALE. MATCH WITH SERIES DETERMINED IN STEP NO. 1. EXAMPLE: 129 V_{RMS}, 20 JOULES (L AND PA SERIES). FOR UNKNOWN ENERGY LEVEL, ESTIMATE BY TYPE OF APPLICATION. LESS THAN 20 AMPS. MAX. TRANSIENT CURRENT, STORED ENERGY IS LOW (E.G., RELAY CONTACT PROTECTION). OR IF VARISTOR IS PLACED AFTER A TRANSIENT-ABSORBING COMPONENT (I.E., TRANSFORMER, INDUCTOR, CAPACITOR), THEN THE MA SERIES (1.7 JOULES) IS A GOOD CHOICE. FOR HIGHER PEAK PULSE CURRENT REQUIREMENTS, CHECK THE ZA, L, OR PA SERIES, DEPENDING ON VOLTAGE.**
 3. **AFTER ENERGY AND APPLIED VOLTAGE LEVEL CONSIDERATIONS, AVERAGE POWER DISSIPATION NEEDS MUST BE CONSIDERED. FOR INFREQUENT TRANSIENTS (ONCE/HOUR, ONCE/DAY), ANY SERIES IS ADEQUATE. FOR FREQUENT TRANSIENTS, OR WHERE RIGID MOUNTING IS REQUIRED, USE THE PA SERIES. FOR SPECIFIC SELECTION, REFER TO INDIVIDUAL SPEC SHEETS AND APPLICATION NOTES.**
-
1. DETERMINER LA TENSION MAXIMALE AUX BORNES DE LA VARISTANCE EN ABSENCE DE SURTENSION. INCLURE TOUTES CONDITIONS. PAR EXEMPLE 220 VOLTS EFFICACES + 10% DE TOLERANCE = 242 VOLTS EFFICACES. REPERER LA TENSION SUR L'ECHELLE HORIZONTALE POUR TROUVER LA SERIE DE GE-MOV APPROPRIEE (PAR EXEMPLE LES SERIES MA, L OU PA) ET SE DEPLACER VERTICALEMENT.
 2. REPERER LE NIVEAU D'ENERGIE INSTANTANEE SUR L'ECHELLE VERTICALE A L'EXTREMITE GAUCHE. FAIRE CORRESPONDRE AVEC LA SERIE CHOISIE AU PARAGRAPHE 1. PAR EXEMPLE 242 VOLTS EFFICES, 20 JOULES (SERIES L ET PA). IL FAUDRA ESTIMER LES NIVEAUX D'ENERGIE INCONNUS SELON L'APPLICATION. EN DESSOUS D'UN COURANT INSTANTANE DE 20A; MAXIMUM, L'ENERGIE EMMAGASINEE EST FAIBLE (PAR EXEMPLE: CONTACT DE PROTECTION DE RELAIS. SI LA VARISTANCE EST PLACEE APRES UN DISPOSITIF QUI ABSORBE LES VARIATIONS INSTANTANEEES (TRANSFORMATEUR, SELF, CAPACITE) ALORS LA SERIE MA (1,7 JOULES) EST UN BON CHOIX. POUR LES IMPULSIONS DE COURANT PLUS ELEVEES, VOIR DANS LES SERIES ZA, L, OU PA.
 3. APRES AVOIR ESTIME L'ENERGIE ET LE NIVEAU DE TENSION APPLIQUEE, IL FAUT CONSIDERER LA PUISSANCE MOYENNE DISSIPEE.
 POUR DES TRANSITOIRES OCCASIONNELS (UNE FOIS PAR HEURE, PAR JOUR ETC. . .), TOUTES LES SERIES GE-MOV SONT ADEQUATES. LES SERIES PA SONT RECOMMANDEES DANS LE CAS DES TRANSITOIRES FREQUENTS ET DES MONTAGES EXIGEANT UNE FIXATION PAR VIS.
 POUR UNE SELECTION SPECIFIQUE, VEUILLEZ VOUS REFERER AUX FEUILLES DE SPECIFICATIONS ET NOTES D'APPLICATIONS PARTICULIERES.
-
1. MAXIMALE DAUERENDE BETRIEBSSPANNUNG OHNE STÖRSPITZEN FESTLEGEN, HIERBEI MÖGLICHE NETZ-DAUER-ÜBERSPANNUNGEN BERÜCKSICHTIGEN, Z.B. $220 V_{eff} + 10\% = 242 V_{eff}$. DIESEN WERT AUF DER WAAGERECHTEN SKALA BESTIMMEN, DANN SENKRECHT DARUNTER DIE ENTSPRECHENDEN GE-MOV®-SERIEN ABLESEN (D.H., MA, L UND PA).
 2. ENERGIE DER STÖRSPITZE ENTSPRECHEND DER ÄUSSERN LINKEN SPALTE FESTLEGEN UND DANN DIE IM SCHRITT 1 ERMITTELTEN GE-MOV®-SERIEN BESTIMMEN. BEISPIEL: $242 V_{eff}$, 20 JOULE = L- UND PA-SERIE BEI ENERGIEN UNBEKANNTER GROSSE DIESE ENTSPRECHEND DEN ANWENDUNGSBEDINGUNGEN ÜBERSCHLÄGRÄ ERMITTELN. BEI WENIGER ALS 20A MAXIMALEM IMPULSSPITZENSTROM IST DIE ZUR ENTLADUNG KOMMENDE ENERGIE GERING (Z.B. RELAIS-KONTAKTSCHUTZ). WENN DER VARISTOR EINEM ÜBERSPANNUNGSABSORBIERENDEN BAUTEIL (Z.B. TRANSFORMATOR, KONDENSATOR) NACHGESCHALTET IST, GENÜGT DIE MA-SERIE (0,1-0,7 J). FÜR HÖHERE IMPULSSPITZENSTRÖME KOMMEN – JE NACH SPANNUNGSWERT – DIE SERIEN ZA, L ODER PA IN BETRACHT.
 3. AUSSER DER STÖRSPITZENENERGIE UND DER BETRIEBSSPANNUNG IST NOCH DIE DURCHSCHNITTLLICHE VERLUSTLEISTUNG ZU BEACHTEN. FÜR WENGER HÄUFIGE STÖRSPITZEN (1 x PRO STUNDE) REICHT JEDE GE-MOV®-SERIE AUS. BEI SEHR HÄUFIGEN STÖRSPITZEN ODER IN FÄLLEN, WO BESONDERS FESTE MONTAGE UNENTBEHRLICH IST, KOMMT NUR DIE PA-SERIE IN BETRACHT.

		MAXIMUM STEADY-STATE APPLIED VOLTAGE																
		TENSION MAXIMALE APPLIQUEE																
		MAXIMALE BETRIEBSSPANNUNG																
E (Joules)	P (Watts)	VOLTS – AC RMS											PACKAGES					
		15	35	75	95	130	150	275	290	420	480	550		575	1000			
		VOLTS – DC																
		20	40	60	80	100	120	140	160	180	200	300	400	500	600	700	800	
.7	0.2	MA SERIES 18-264 VRMS 23-365 VDC											MPPC 10-20A					
.6-15	.17-.55	ZA SERIES 10-115 VRMS 14-153 VDC											MPPC 1000-2000A 250-500A					
1-160	.24-13	L SERIES 95-1000 VRMS 130-1200 VDC											MPPC 4000A 400A 2000A					
10-80	3-15	PA SERIES 130-575 VRMS 170-750 VDC											MPPC 4000A					
150-320		HE SERIES 130-660 VRMS 175-850 VDC											MPPC 10,000A					

MPPC = MAX. PEAK PULSE CURRENT
 = AMPLITUDE MAXIMUM DE L'IMPULSION DE COURANT
 = MAX. SPITZENSTROMWERT

P = AVERAGE POWER DISSIPATION
 = PUISSANCE MOYENNE DISSIPÉE
 = DURCHSCHNITTLICHE VERLUSTLEISTUNG

E = ENERGY
 = ENERGIE
 = ENERGIE

THE CASE FOR GE-MOV™ VARISTORS

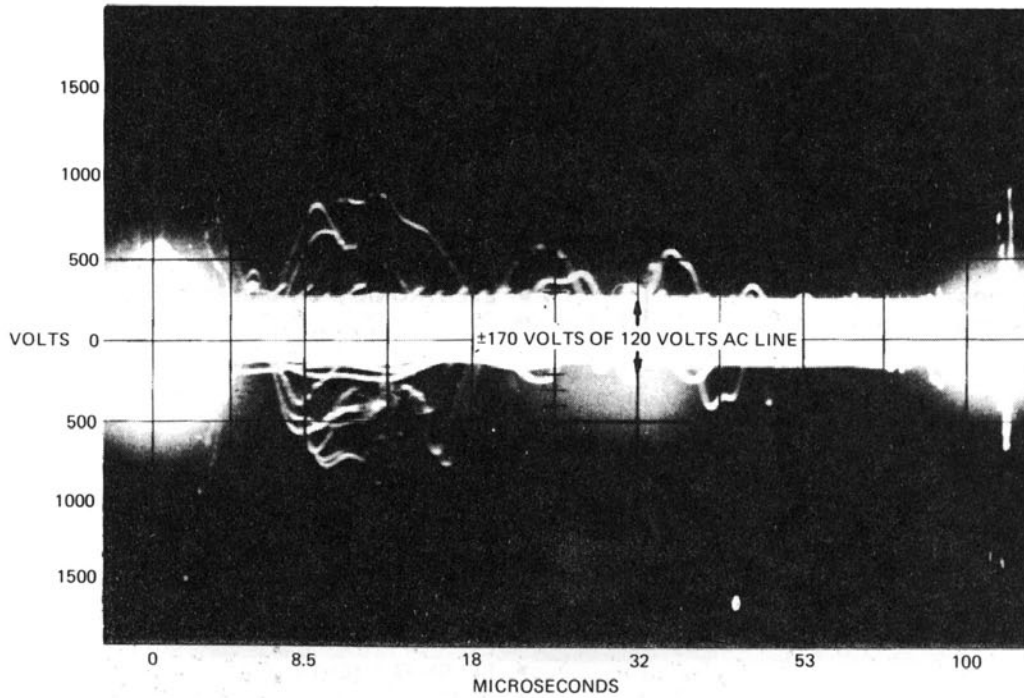

ACTUAL PHOTOGRAPH OF OSCILLOSCOPE RECORDING OF A HOUSEHOLD POWER LINE INPUT (24 HOURS).

ENREGISTREMENT SUR 24 H – EFFECTUE SUR SECTEUR 110V. (U.S.A.).

OSZILLOGRAMM DES SPANNUNGSVERLAUFS WÄHREND 24 STUNDEN IN EINEM 220V-NETZ

VOLTAGE TRANSIENT PROBLEMS CAN BE CAUSED BY:
DES TRANSITOIRES PEUVENT ETRE PRODUITS PAR:
ÜBERSpannungSSPITZEN KÖNNEN ENTSTEHEN DURCH:

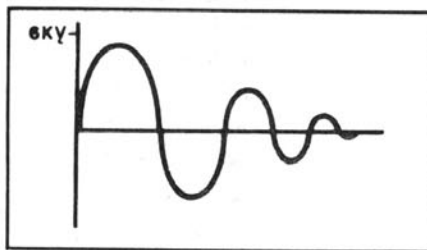

LIGHTNING
FOUDRE
BLITZSCHLAG

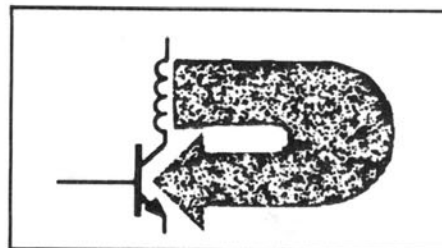

TURNING OFF INDUCTIVE COMPONENTS
BLOCAGE D'UNE CHARGE INDUCTIVE
ABSCHALTEN INDUKTIVER LASTEN

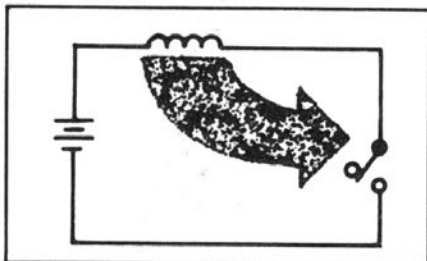

CONTACT
COMMUTATION MECANIQUE
SCHALTvorgÄNGE

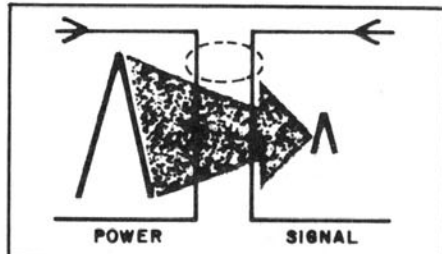

ELECTROMAGNETIC COUPLING (NOISE)
COUPLAGE ELECTROMAGNETIQUE
ELEKTROMAGNETISCHE KOPPLING

GE-MOV® VARISTOR CLAMP DANGEROUS VOLTAGE TRANSIENTS AND DISSIPATE THEM AS HARMLESS HEAT ENERGY.

LES VARISTANCES GE-MOV ECRETENT LES TRANSITOIRES DE TENSION DANGEREUX EN LES DISSIPANT SOUS FORME D ENERGIE THERMIQUE.
 GE-MOV-VARISTOREN BEGRENZEN GEFÄHRliche ÜBERSpannungSSPITZEN UND WANDELN SIE UM IN HARMLOSE HITZE-ENERGIE.

ZA SERIES
SERIES ZA
ZA-SERIE

APPLICATIONS

- SOLID STATE MOTOR CONTROL
- SOLID STATE RELAYS/TIMERS
- AC LINE CORD PROTECTION
- CONTROL ARC SUPPRESSION
- TRAFFIC CONTROLLERS
- COMMUNICATION EQUIPMENT
- AUTOMOBILES
- CALCULATORS
- SMOKE DETECTORS
- INSTRUMENTATION

APPLICATIONS

- COMMANDE ELECTRONIQUE DE MOTEUR
- RELAIS ET TEMPORISATEURS ELECTRONIQUES
- SUPPRESSION D'ARC
- PROTECTION DE CONTACTS
- AUTOMOBILES
- CALCULATEURS
- DETECTEURS DE FUMEE
- INSTRUMENTATION
- TELEPHONES ET RELAIS

ANWENDUNGEN

- ELEKTRONISCHE ANTRIEBE
- ELEKTRONISCHE RELAIS/ZEITSCHALTER
- NETZKABELZUFÜHRUNGEN
- KONTAKTSCHUTZ
- TELEFON/TELEX
- AUTOMOBILE
- RAUCHGASMELDER
- MESS- UND ANZEIGEGERATE

REPLACEMENT FOR THE FOLLOWING WHEN USED AS TRANSIENT SUPPRESSOR:

- SELENIUM TRYECTORS
- ZENER DIODES
- SILICON CARBIDE
- GAS DISCHARGE TUBES
- R-C NETWORKS (NON DV/DT)
- NEON BULBS
- ELECTRONIC CROWBAR CIRCUITS

EN REPLACEMENT DES DISPOSITIFS SUIVANTS

- CELLULES AU SELENIUM
- DIODES ZENER
- TUBES A DECHARGE
- RESEAUX R-C (NON DV/DT)
- LAMPES NEON
- ELECTRONIQUE DE COURT-CIRCUIT

ALS AUSTAUSCH FÜR

- SELEN-ELEMENTE
- ZENERDIODEN
- SIC-VARISTOREN
- ENTLADUNGSRÖHREN
- R-C – GLIEDER (AUSSER FÜR DV/DT)
- "CROWBAR" – SCHALTUNGEN

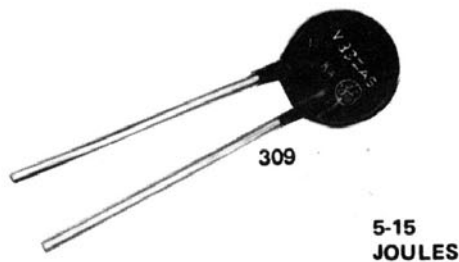
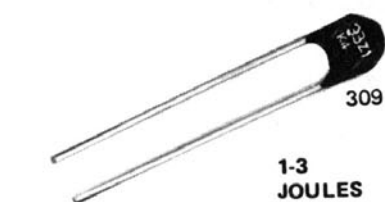

MODEL NUMBER	MAXIMUM APPLIED VOLTAGE			MAXIMUM ENERGY JOULES (WATT-SECS)	MAXIMUM NON-REPETITIVE PEAK PULSE CURRENT $t_p \leq 6 \mu S$ AMPS	MAXIMUM AVERAGE POWER DISSIPATION WATTS	MAXIMUM VARISTOR VOLTAGE AT 1 AMP/ PEAK VOLTS
	AC-RMS	AC-PEAK 50-60Hz	DC				
	VOLTS	VOLTS	VOLTS				
V18ZA1 V18ZA3	10	14	14	0.5 3.0	250 1000	0.18 0.40	35 32
V22ZA1 V22ZA3	14	19	18	0.6 3.0	250 1000	0.17 0.40	46 43
V24ZA1 V24ZA4	15	21	20	0.8 4.0	250 1000	0.18 0.40	46 43
V27ZA1 V27ZA4	17	24	22	0.8 4.0	250 1000	0.18 0.40	54 52
V33ZA1 V33ZA5	20	28	26	1.0 5.0	250 1000	0.19 0.40	60 58
V39ZA1 V39ZA6	25	35	31	1.2 6.0	250 1000	0.20 0.45	70 65
V47ZA1 V47ZA7	30	42	38	1.4 7.0	250 1000	0.21 0.45	82 76
V56ZA2 V56ZA8	35	49	45	1.7 8.0	250 1000	0.22 0.45	86 91
V68ZA2 V68ZA10	40	57	56	2.0 10.0	250 1000	0.24 0.50	112 108
V82ZA2 V82ZA12	50	71	66	2.5 12.0	250 1000	0.25 0.50	135 130
V100ZA3 V100ZA15	60	85	81	3.0 15.0	250 1000	0.26 0.55	160 154
V120ZA1 V120ZA6	75	106	102	1.0 6.0	500 2000	0.20 0.45	200 190
V150ZA1 V150ZA8	85	134	127	1.2 8.0	500 2000	0.20 0.45	245 240
V180ZA1 V180ZA10	115	163	153	1.5 10.0	500 2000	0.20 0.45	285 290

PA SERIES
SERIES PA
PA-SERIE

RIGID MOUNTING • UP TO 15W DISSIPATION •
VOLTAGE RANGE 130-575 VRMS, 170-750 VDC • PEAK PULSE CURRENT TO 4000A •
MEETS EMA CREEP AND STRIKE DISTANCE

ROBUSTESSE DE MONTAGE • DISSIPATION JUSQU'À 15W •
GAMME DE TENSION: 130-575 V_{eff} , 170-750 V. CONTINU • AMPLITUDE
MAXIMALE D'IMPULSION EN COURANT: JUSQU'À 4000A
CONFORME AUX NORMES AFNOR EN CE QUI CONCERNE SA LIGNE DE FUITE

SCHRAUBBAR FÜR BESONDERS FESTE MONTAGE •
BIS ZU 15 W VERLUSTLEISTUNG • WECHSELSPANNUNG 130-575 VOLT •
GLEICHSPANNUNGEN 170-750 VOLT • IMPULSSPITZENSTRÖME BIS 4000 A •
ENTSPRICHT DEN VDE-VORSCHRIFTEN ÜBER KRIECH- UND
LUFTSTRECKEN (VDE 0110)

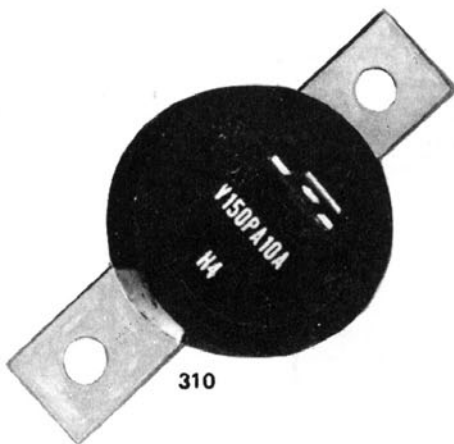

MODEL NUMBER	MAXIMUM APPLIED VOLTAGE			MAXIMUM ENERGY JOULES (WATT-SEC)	MAXIMUM NON-REPETITIVE PEAK PULSE CURRENT $t_p \leq 6 \mu S$ AMPS	MAXIMUM AVERAGE POWER DISSIPATION WATTS	MAXIMUM VARISTOR VOLTAGE AT 10 AMP/PEAK VOLTS
	AC-RMS	AC-PEAK 50-60Hz	DC				
	VOLTS	VOLTS	VOLTS				
V130PA10A	130	184	170	10	4000	8	350
V130PA20A				20		15	350
V130PA20B				20		15	340
V130PA20C				20		15	320
V150PA10A	150	212	195	10		8	410
V150PA20A				20		15	410
V150PA20B				20		15	390
V150PA20C				20		15	360
V250PA10A	250	354	330	10		4	670
V250PA20A				20		7	670
V250PA40A				40		13	670
V250PA40B				40		13	640
V250PA40C	40	13	600				
V275PA10A	275	389	360	10		4	740
V275PA20A				20		7	740
V275PA40A				40		13	740
V275PA40B				40	13	700	
V275PA40C	40	13	650				
V320PA40A	320	452	415	40	12	850	
V320PA40B				40	12	810	
V320PA40C				40	12	780	
V420PA20A	420	595	540	20	5	1120	
V420PA40A				40	10	1120	
V420PA40B				40	10	1090	
V420PA40C				40	10	1000	
V460PA20A	460	650	600	20	5	1280	
V460PA40A				40	10	1280	
V460PA40B				40	10	1200	
V460PA40C				40	10	1120	
V480PA20A	480	679	625	20	3	1320	
V480PA40A				40	5	1320	
V480PA80A				80	10	1320	
V480PA80B				80	10	1250	
V480PA80C	80	10	1180				
V510PA20A	510	721	655	20	3	1400	
V510PA40A				40	5	1400	
V510PA80A				80	10	1400	
V510PA80B				80	10	1310	
V510PA80C	80	10	1280				
V550PA20A	550	778	720	20	3	1500	
V550PA40A				40	5	1500	
V550PA80A				80	9	1500	
V550PA80B				80	9	1410	
V550PA80C	80	9	1340				
V575PA20A	575	813	750	20	3	1520	
V575PA40A				40	5	1520	
V575PA80A				80	9	1520	
V575PA80B				80	9	1460	
V575PA80C	80	9	1400				

MA SERIES
SERIES MA
MA-SERIE

LOW COST • DESIGNED FOR AUTOMATIC INSERTION • MOLDED AXIAL PACKAGE
• VOLTAGES 18-264 VRMS, 26-365 VDC • ENERGY ABSORPTION TO 700 MILLI
JOULES • PEAK PULSE CURRENT TO 20A

BAS PRIX • ADAPTE A L'INSERTION AUTOMATIQUE • BOITIER AXIAL MOULE
GAMME DE TENSION: 18-264 V_{eff}, 26-365 V. CONTINU • ABSORPTION
D'ENERGIE JUSQU'A 700 mJ • AMPLITUDE MAXIMALE D'IMPULSION
EN COURANT: JUSQU'A 20A

PREISGÜNSTIG • AUSGELEGT FÜR AUTOMATISCHE BESTÜCKUNG •
AXIALKONSTRUKTION • WECHSELSPANNUNG 18-264 V_{eff}, GLEICHSPANNUNG
23-365 VOLT • ENERGIEAUFNAHME BIS 700 mJ • SPITZENIMPULSSTRÖME BIS 20A



MODEL NUMBER	MAXIMUM APPLIED VOLTAGE			MAXIMUM ENERGY JOULES (WATT-SECS)	MAXIMUM NON-REPETITIVE PEAK PULSE CURRENT $t_p \leq 6 \mu S$ AMPS	MAXIMUM AVERAGE POWER DISSIPATION M-WATTS	MAXIMUM VARISTOR VOLTAGE AT 1 AMP/PEAK VOLTS
	AC-RMS	AC-PEAK 50-60Hz	DC				
	VOLTS	VOLTS	VOLTS				
NOTE: GE-MOV® Varistor MA Series Models from 20-75 V_{RMS}, 26-102 V_{DC} are available.							
V150MA1A	88	124	121	10	10	200	280
V150MA2B	92	130	137	20	20		250
V180MA1A	105	148	144	15	10	200	350
V180MA3B	110	156	152	30	20		320
V220MA2A	132	187	181	20	10	200	420
V220MA4B	138	195	191	40	20		390
V270MA2A	163	230	224	20	10	200	530
V270MA4B	171	242	235	40	20		460
V330MA2A	188	266	257	25	10	200	640
V330MA5B	200	283	274	50	20		560
V390MA3A	234	331	322	30	10	200	750
V390MA6B	242	342	334	60	20		700
V430MA3A	253	358	349	35	10	200	840
V430MA7B	264	373	365	70	20		750

L SERIES
SERIES L
L-SERIE

PROTECTION UP TO 95-1000 VRMS, 130-200 VDC • 4000A PEAK PULSE CURRENT CAPABILITY • ENERGY ABSORPTION TO 160 JOULES

PROTECTION JUSQU'A 95-1000 V_{eff}. 130-200V CONTINU. • AMPLITUDE MAXIMALE D'IMPULSION EN COURANT DE 4000A • ABSORPTION D'ENERGIE: JUSQU'A 160 JOULES

WECHSELSPANNUNG 95-1000 VOLT • GLEICHSPANNUNG 130-1200 VOLT, IMPULSSPITZENSTRÖME BIS 4000A • ENERGIEAUFNAHME BIS 160 JOULE

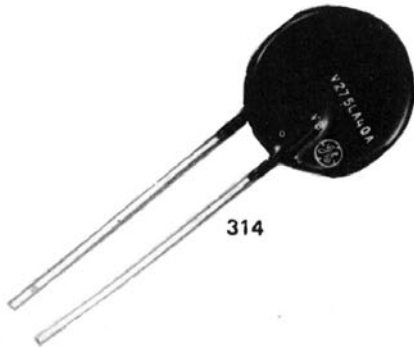

314



313



312

MODEL NUMBER	MAXIMUM APPLIED VOLTAGE			MAXIMUM ENERGY JOULES (WATT-SECS)	MAXIMUM NON-REPETITIVE PEAK PULSE CURRENT I _p ≤ 6 μS AMPS	MAXIMUM AVERAGE POWER DISSIPATION WATTS	MAXIMUM VARISTOR VOLTAGE AT 1 AMP/PEAK VOLTS
	AC-RMS	AC-PEAK 50-60Hz	DC				
	VOLTS	VOLTS	VOLTS				
V95LA7A V95LA7B	95	134	130	7	2000	0.45	245 220
V130LA1				1	400	.24	360
V130LA2				2	400	.24	360
V130LA10A	130	184	175	10	2000	.50	340
V130LA20A				20	4000	.85	340
V130LA20B				20	4000	.85	505
V150LA1				1	400	0.24	420
V150LA2				2	400	0.24	420
V150LA10A	150	212	200	10	2000	0.50	390
V150LA20A				20	4000	0.85	390
V150LA20B				20	4000	0.85	355
V250LA2				2	400	0.28	690
V250LA4				4	400	0.28	690
V250LA15A	250	354	330	15	2000	0.60	640
V250LA20A				20	2000	0.60	640
V250LA40A				40	4000	0.90	640
V250LA40B				40	4000	0.90	580
V275LA2				2	400	0.28	750
V275LA4				4	400	0.28	750
V275LA15A	275	389	369	15	2000	0.60	700
V275LA20A				20	2000	0.60	700
V275LA40A				40	4000	0.90	700
V275LA40B				40	4000	0.90	645
V300LA2	300	424	405	2	400	0.28	830
V300LA4				4	400	0.28	830
V320LA15A				15	2000	6	780
V320LA20A	320	452	420	20	2000	6	780
V320LA40A				40	4000	9	780
V320LA40B				40	4000	9	740
V420LB20A				20	2000	0.55	1050
V420LB40A	420	595	560	40	4000	0.90	1050
V420LB40B				40	4000	0.90	980
V460LB20A				20	2000	0.55	1180
V460LB40A	460	650	615	40	4000	0.90	1180
V460LB40B				40	4000	0.90	1080
V480LB20A				20	2000	0.55	1200
V480LB40A	480	679	640	40	2000	0.70	1200
V480LB80A				80	4000	1.00	1110
V480LB80B				80	4000	1.00	1110
V510LB20A				20	2000	0.55	1300
V510LB40A	510	721	675	40	2000	0.70	1300
V510LB80A				80	4000	1.00	1300
V510LB80B				80	4000	1.00	1200
V550LB20A				20	2000	0.60	1400
V550LB40A	550	778	700	40	2000	0.70	1400
V550LB80A				80	4000	1.00	1400
V550LB80B				80	4000	1.00	1300
V575LB20A				20	2000	0.65	1480
V575LB40A	575	813	730	40	2000	0.80	1480
V575LB80A				80	4000	1.10	1480
V575LB80B				80	4000	1.10	1340
V1000LB80A				80	2000	0.9	2500
V1000LB160A	1000	1414	1200	160	4000	1.3	2500
V1000LB160B				160	4000	1.3	2400

HE SERIES
SERIE HE
HE-SERIE

DESIGNED FOR HIGH ENERGY ABSORPTION: UP TO 320 JOULES •
PROTECTION UP TO 130-660 VRMS, 184-933 VDC •
PEAK PULSE CURRENT TO 10,000 AMPS

CONÇU POUR ABSORBER DES TRANSITOIRES DE TRES FORTE ENERGIE:
 JUSQU'A 320 JOULES • GAMME DE TENSION DE 130-660 VRMS, 184-933V.
 CONTINU. • AMPLITUDE DE COURANT JUSQU'A 10,000 A

WECHSELSPANNUNG 130-660V • GLEICHSPANNUNG 184-933V
 • IMPULSSPITZENSTRÖME BIS 10,000A • ENERGIEAUFNAHME BIS 320J



MAXIMUM RATINGS AND CHARACTERISTICS

MODEL NUMBER	MAXIMUM RATINGS					CHARACTERISTICS		
	STEADY STATE			TRANSIENT		VARISTOR PEAK VOLTAGE 1mA AC PEAK VOLTS (MAX.)	VARISTOR PEAK VOLTAGE @ 100A VOLTS (MAX.)	TYPICAL CAPACITANCE f = .1-1 MHz PICOFARADS
	RMS APPLIED VOLTAGE VOLTS	RECURRENT PEAK IDLE VOLTAGE VOLTS	DC APPLIED VOLTAGE VOLTS	ENERGY JOULES	PEAK PULSE CURRENT AMPS			
V130HE150	130	175	184	150	10,000	252	350	4700
V150HE150	150	200	212	150	10,000	292	420	4000
V250HE250	250	330	354	250	10,000	470	670	2500
V275HE250	275	370	389	250	10,000	514	740	2250
V320HE250	320	420	453	250	10,000	615	880	1900
V420HE250	420	560	594	250	10,000	817	1180	1400
V480HE300	480	640	679	300	10,000	898	1290	1300
V510HE300	510	675	721	300	10,000	941	1380	1200
V575HE320	575	750	813	320	10,000	1095	1570	1100
V660HE320	660	850	933	320	10,000	1265	1800	900

POWER MODULES

MODULES DE PUISSANCE

LEISTUNGS - MODULE

NEW GENERAL ELECTRIC POWER MODULES ARE MINIATURIZED, SELF-CONTAINED, EPOXY ENCAPSULATED MODULES CAPABLE OF PERFORMING BASIC AC TO DC CONVERSION FUNCTIONS. TYPICAL APPLICATIONS INCLUDE - DC POWER SUPPLIES, DC MOTOR CONTROLS, BATTERY CHARGERS, MAGNETIC CLUTCHES AND BRAKES.

ALL GENERAL ELECTRIC POWER MODULES INCORPORATE POWER GLAST™ PASSIVATED SEMICONDUCTORS WITH THE LATEST PELLET MOUNTDOWN AND INTERCONNECT TECHNIQUES, THEREBY ASSURING THE UTMOST IN RELIABILITY.

LES NOUVEAUX MODULES DE PUISSANCE FABRIQUES PAR GENERAL ELECTRIC SONT MINIATURISES ET MOULES AVEC DE L'EPOXYDE. ILS REMPLACENT LES MONTAGES CONVENTIONNELS A THYRISTORS DISCRETS.

LES PRINCIPALES APPLICATIONS EN SONT L'ALIMENTATION DE PUISSANCE EN COURANT CONTINU, COMMANDE DE MOTEURS A COURANT CONTINU, CHARGEURS DE BATTERIE, EMBRAYAGES ET FREINS ELECTROMAGNETIQUES. DANS CES MODULES DE PUISSANCE, GENERAL ELECTRIC UTILISE DES SEMICONDUCTEURS DE PUISSANCE PASSIVES AU VERRE MONTES ET CONNECTES SELON LES PLUS RECENTES TECHNIQUES. AFIN D'ASSURER UNE MEILLEURE FIABILITE.

DIE NEUEN GENERAL ELECTRIC POWER-MODULE SIND MINIATURISIERTE, IN EPOXIDHARZ VERGOSSENE, EINBAUFERTIGE BAUSTEINE, DIE HAUPTSÄCHLICH FÜR STROMRICHTER - ZWECHE VERWENDUNG FINDEN.

TYPISCHE ANWENDUNGEN SIND U.A. GLEICHSTROMNETZGERÄTE, GLEICHSTROM-MOTORSTEUERUNGEN, BATTERIELADGERÄTE. MAGNETKUPPLUNGEN UND -BREMSEN. ALLE GENERAL ELECTRIC POWER-MODULE ENTHALTEN POWER GLAST™ PASSIVIERTE HALBLEITERBAUELEMENTE, DIE DEM NEUESTEN STAND DER CHIP-BEFESTIGUNGS- UND -ANSCHLUSS-TECHNIK ENTSPRECHEN. HIERDURCH WIRD HÖCHSTE BETRIEBSZUVERLÄSSIGKEIT ERZIELT.

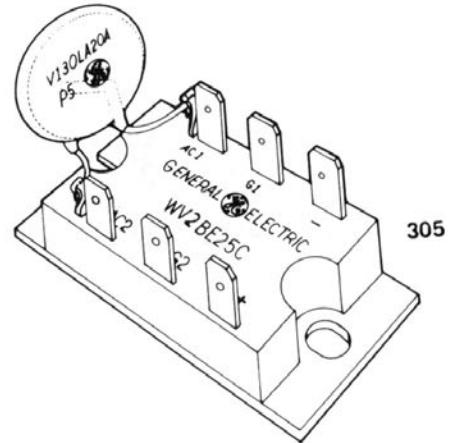

COMMON CHARACTERISTICS @ 25°C

Isolation Breakdown	2,500 V _{PEAK}
Surge, Peak One Cycle	300 A
Fusing, I ² t @ 8.3 msec	370 A ² SEC
Gate Current to Trigger (Max.)	40 mA
Gate Voltage to Trigger (Max.)	2.5 V
On-State Current Rate of Rise (di/dt)	100 A/μSEC
Off-State Voltage Rate of Rise (dv/dt)	20 V/μSEC
Operating Temperature	-40 to 125°C

BASIC CIRCUIT SCHEMATIC	I _O AVERAGE @ 85° (A)	V _{IN} (V)	GE TYPES			
			BASIC CIRCUIT	WITHOUT FREE WHEELING DIODE	WITHOUT GE-MOV® VARISTOR	WITHOUT EITHER DIODE OR VARISTOR
	25	120	WV2BE25C	WV2BC25C	W2BE25C	W2BC25C
		240	WV2BE25E	WV2BC25E	W2BE25E	W2BC25E
	25	120	WV2BJ25C	WV2BK25C	W2BJ25C	W2BK25C
		240	WV2BJ25E	WV2BK25E	W2BJ25E	W2BK25E
	25	120	WV2BA25C	—	W2BA25C	—
		240	WV2BA25E	—	W2BA25E	—

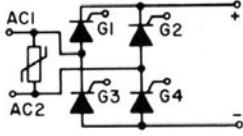
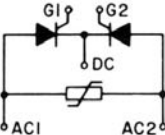
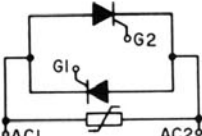
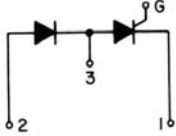
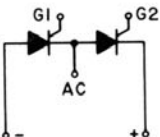
			GE TYPES	
BASIC CIRCUIT SCHEMATIC	I_O AVER. @ 85°C (A)	V_{IN} (V)	BASIC CIRCUIT	WITHOUT GE-MOV® VARISTOR
	25	120	WV2BH25C	W2BH25C
		240	WV2BH25E	W2BH25E
	25	120	WV2CA25C	W2CA25C
		240	WV2CA25E	W2CA25E
	50A RMS	120	WV2AA50C	W2AA50C
		240	WV2AA50E	W2AA50E
	<p align="center">BASIC BUILDING BLOCK MODULES</p> <p>FOR FURTHER INFORMATION ON THESE AND OTHER CUSTOM CIRCUIT TYPES, CONTACT:</p> <p>POUR TOUTE INFORMATION COMPLEMENTAIRE, CONTACTER:</p> <p>ZUSÄTZLICHE ANGABEN HIERÜBER UND ÜBER WEITERE LIEFERBARE AUSFUHRÜNGEN ERHALTEN SIE VON:</p> <p>ELECTRONICS TRADING COMPANY DUNDALK, IRELAND</p> <p>Phone: Dundalk 32371 thru 32380 Telex: 33816 Telegrams and Cables: ... E.T.C., Dundalk, Ireland</p>			
				

SUBSCRETE™ DEVICES POWER SERIES

PASTILLES POUR CIRCUITS HYBRIDES
PASTILLES DE PUISSANCE

"SUBSCRETE™" BAUTEILE
LEISTUNGSSERIE

- TRIACS
- TRIACS
- TRIACS

- SCR'S
- THYRISTORS
- THYRISTOREN

- RECTIFIERS
- REDRESSEURS
- GLEICHRICHTER

PACKAGE CONFIGURATION
0 = Step Lead
1 = Isolated Step Lead
2 = Sandwich

VOLTAGE GRADE
A = 100 D = 400
B = 200 E = 500
C = 300 M = 600

EXAMPLE: 6 amp, 400 volt,
Step Lead, Subscrete™
Triac is a MPA1060D.

CURRENT RATINGS (RMS)	GE TYPE	I _{FSM} PEAK ONE FULL CYCLE SURGE (NON-REP) ON-STATE CURRENT @ 60 Hz AMPERES (MAXIMUM)	I _{ORM} PEAK OFF-STATE CURRENT mA (MAXIMUM)	V _{TM} PEAK ON-STATE VOLTAGE VOLTS (MAXIMUM)	dv/dt (STATIC) CRITICAL RATE-OF-RISE OF OFF-STATE VOLTAGE T _J = 100°C VOLTS/μ SEC	dv/dt (COMMUTATING) CRITICAL RATE-OF-RISE OF OFF-STATE VOLTAGE T _J = 100°C, 60Hz @ RATED RMS CURRENT VOLTS/μ SEC (MINIMUM)	I _{GT} DC GATE TRIGGER CURRENT MT2+ GATE+ MT2- GATE- mAdc (MAXIMUM)	V _{GT} DC GATE TRIGGER VOLTAGE Vdc (MAXIMUM)	I _H HOLDING CURRENT mAdc (MAXIMUM)	I _L LATCHING CURRENT MT2+ GATE+ MT2- GATE- mAdc (MAXIMUM)	R _{θJC} MAXIMUM APPARENT THERMAL IMPEDANCE @ 60 Hz °C/WATT (MAX.)		T _J JUNCTION OPERATING TEMP. RANGE °C	
											NON-ISOL.	ISOL.		
TRIACS	6 Amperes	MPA106	80	0.1	1.83 @ I _{TM} = 8.5A pk.	25	4	50	2.5	50	200	2.2	3.4	-40 to +100
	10 Amperes	MPA110	100	0.1	1.65 @ I _{TM} = 14.0A pk.	50	4	50	2.5	50	200	1.5	2.7	-40 to +100
	15 Amperes	MPA115	120	0.1	1.52 @ I _{TM} = 21.0A pk.	100	4	50	2.5	50	200	1.3	2.5	-40 to +100
	25 Amperes	MPA125	250	0.2	1.58 @ I _{TM} = 35.0A pk.	25	4	50	2.5	75	200	1.2	1.9	-40 to +100
	40 Amperes	MPA140	300	0.2	1.38 @ I _{TM} = 56.0A pk.	25	4	80	2.5	75	200	0.8	1.2	-40 to +100
SCR'S	CURRENT RATINGS (RMS)	GE TYPE	I _{FSM} PEAK ONE FULL CYCLE SURGE (NON-REP) ON-STATE CURRENT @ 60 Hz AMPERES (MAXIMUM)	I _{ORM} /I _{RRM} PEAK OFF-STATE OR REVERSE CURRENT mA (MAXIMUM)	V _{TM} PEAK ON-STATE VOLTAGE VOLTS (MAXIMUM)	dv/dt (STATIC) CRITICAL RATE-OF-RISE OF OFF-STATE VOLTAGE T _J = 100°C VOLTS/μ SEC (TYPICAL)	t _q CIRCUIT COMMUTATED TURN-OFF TIME T _J = 100°C μ SEC (TYPICAL)	I _{GT} DC GATE TRIGGER CURRENT mAdc (MAXIMUM)	V _{GT} DC GATE TRIGGER VOLTAGE Vdc (MAXIMUM)	I _H HOLDING CURRENT mAdc (MAXIMUM)	I _L LATCHING CURRENT mAdc (MAXIMUM)	R _{θJC} STEADY-STATE THERMAL RESISTANCE °C/WATT (MAXIMUM)		T _J JUNCTION OPERATING TEMP. RANGE °C
			NON-ISOL.	ISOL.										
	10 Amperes	MPA210	90	0.1	1.95 @ I _{TM} = 20.0A pk.	50	50	25	1.5	30	60	1.8	4.0	-40 to +100
	25 Amperes	MPA225	250	0.2	1.5 @ I _{TM} = 50.0A pk.	50	50	25	1.5	50	100	1.7	2.5	-40 to +100
35 Amperes	MPA235	300	0.2	1.9 @ I _{TM} = 70.0A pk.	50	50	40	2.5	75	150	1.7	2.5	-40 to +100	
RECTIFIERS	CURRENT RATINGS (RMS)	GE TYPE	I _{FSM} PEAK ONE CYCLE SURGE (NON-REP) FORWARD CURRENT @ 60 Hz AMPERES (MAXIMUM)	I _{RRM} PEAK REVERSE CURRENT mA (MAXIMUM)	V _{FM} MAXIMUM PEAK FORWARD VOLTAGE VOLTS (MAXIMUM)	R _{θJC} STEADY-STATE THERMAL RESISTANCE °C/WATT (MAXIMUM)		T _J JUNCTION OPERATING TEMP. RANGE °C						
			NON-ISOL.	ISOL.										
30 Amperes	MPA330	300	0.2	1.5 @ I _{FM} = 60A pk.	1.7	2.5	-40 to +175							

- NOTES:**
- All characteristics given for T_J = 25°C unless otherwise stated.
 - R_{θJC} Definition:
 - For Non-Isolated Configurations: Thermal resistance from junction to geometric center of bottom plate.
 - For Isolated Configurations: Thermal resistance from junction to bottom of substrate under geometric center of chip.
 - Most maximum allowable ratings depend almost entirely on the quality and thermal characteristics of the bond when mounting the Subscrete™ Device. For this reason, normal ratings such as average current, surge current and operating temperature range, are obtainable when the solder thickness is limited to ≤ 3 mils and good wetting is achieved.

1

NOTE 1: Lead diameter is controlled in the zone between .070 and .250 from the seating plane. Between .250 and end of lead a max. of .021 is held.

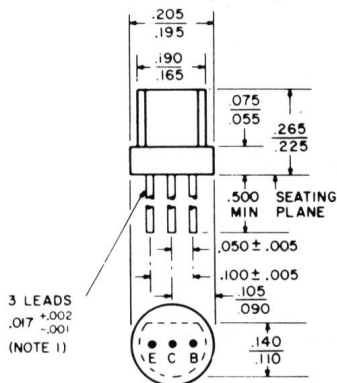

ALL DIMEN. IN INCHES AND ARE REFERENCE UNLESS TOLERANCED

1.2

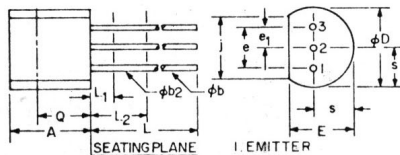

SYMBOL	MILLIMETERS		INCHES		NOTES
	MIN.	MAX.	MIN.	MAX.	
A	4.320	5.330	1.70	2.10	
phi b	4.07	5.50	0.16	0.22	1,3
phi b2	4.07	4.82	0.16	0.19	3
phi D	4.450	5.200	1.75	2.05	
E	3.180	4.190	1.25	1.65	
e	2.410	2.670	0.95	1.05	
e1	1.150	1.395	0.45	0.55	
L	3.430	4.320	1.35	1.70	
L1	12.700	—	5.00	—	1,3
L2	—	1.270	—	0.50	3
L2	6.350	—	2.50	—	3
Q	2.920	—	1.15	—	2
s	2.030	2.670	0.80	1.05	

NOTES:
 1. THREE LEADS
 2. CONTOUR OF PACKAGE UNCONTROLLED OUTSIDE THIS SIDE.
 3. (THREE LEADS) phi b2 APPLIES BETWEEN L1 AND L2. phi b APPLIES BETWEEN L2 AND 12.70 MM (.500") FROM THE SEATING PLANE. DIAMETER IS UNCONTROLLED IN L1 AND BEYOND 12.70 MM (.500") FROM SEATING PLANE.

16

DIMENSIONS WITHIN JEDEC OUTLINE TO-98

NOTE 1: Lead diameter is controlled in the zone between .070 and .250 from the seating plane. Between .250 and end of lead a max. of .021 is held.

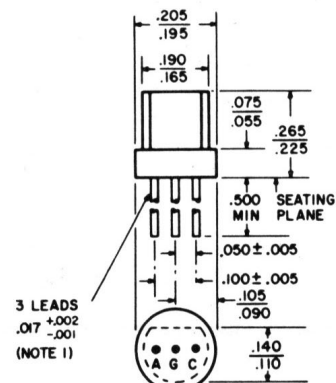

ALL DIMEN. IN INCHES AND ARE REFERENCE UNLESS TOLERANCED

28

DIMENSIONS WITHIN JEDEC OUTLINE TO-18 EXCEPT FOR LEAD CONFIGURATION

NOTE 1: Lead diameter is controlled in the zone between .050 and .250 from the seating plane. Between .250 and end of lead a max. of .021 is held.

NOTE 2: Leads having maximum diameter (.019) measured in gaging plane. 0.54 ± .001 below the seating plane of the device shall be within .007 of true position relative to a maximum width tab.

NOTE 3: Measured from max. diameter of the actual device.

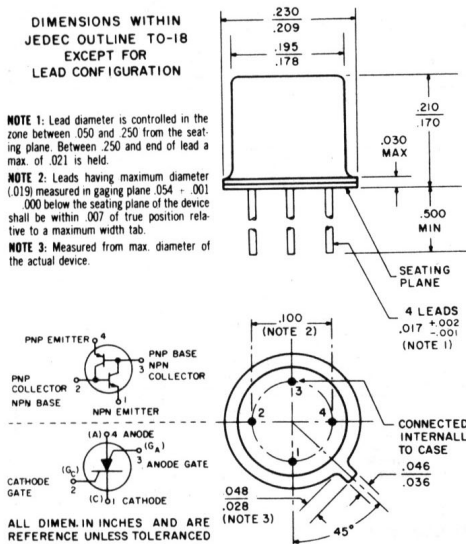

ALL DIMEN. IN INCHES AND ARE REFERENCE UNLESS TOLERANCED

29, 30

NOTE 1: Max diameter leads at a gaging plane .054 ± .001 below base seat to be within .007 of their true location relative to max. width tab and to the max. .230 diameter measured with a suitable gage. When gage is not used, measurement will be made at base seat.

NOTE 2: Lead diameter is controlled in the zone between .050 and .250 from the base seat. Between .250 and end of lead a max. of .021 is held.

NOTE 3: Calculated by measuring flange diameter, including tab and excluding tab and subtracting the smaller diameter from the larger diameter.

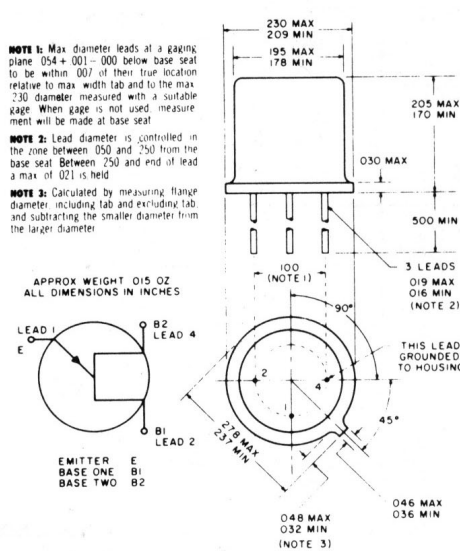

31

NOTE 1: This zone is controlled for automatic handling. The variation in actual diameter within this zone shall not exceed .010.

NOTE 2: Measured from max diameter of the actual device.

NOTE 3: The specified lead diameter applies in the zone between .050 and .250 from the base seat. Between .250 and 1.5 maximum of .021 diameter is held. Outside of these zones the lead diameter is not controlled.

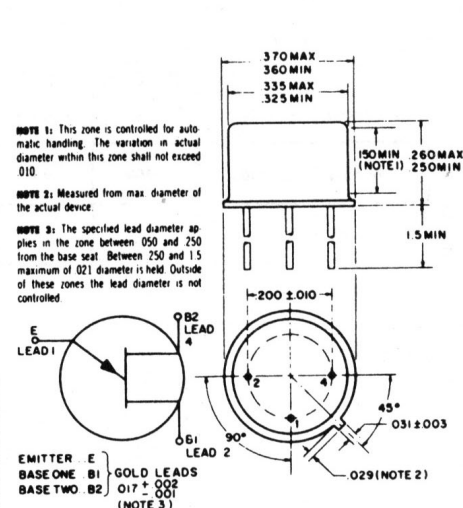

38, 39

1N4531, 1N4536

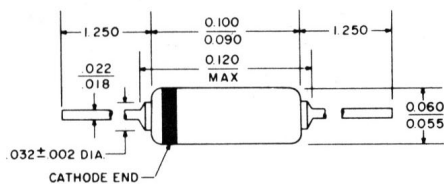

1N914, A, B, 1N916, A, B, 1N4148, 49, 54, 1N4446-49

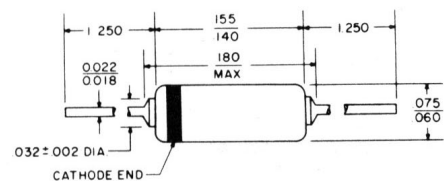

NOTE: ALL DIMENSIONS IN INCHES

40, 41, 42

1N5179 MPD400

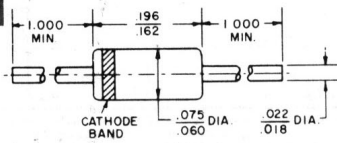

1N4830 1N4157 MPD300

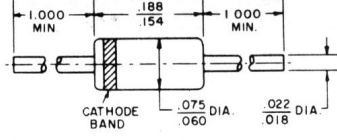

1N4829 1N4156 MPD200

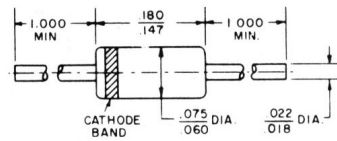

NOTES:
 1. ALL DIMENSIONS ARE IN INCHES AND ARE REFERENCE UNLESS TOLERANCED.
 2. LEAD DIAMETER NOT CONTROLLED WITHIN .050" OF THE BODY.
 3. BODY CONTOUR IS OPTIONAL WITHIN THE DIMENSIONS GIVEN. SLUGS, IF ANY, ARE INCLUDED WITHIN THIS CYLINDER AND ARE NOT SUBJECT TO THE MINIMUM BODY DIAMETER.
 4. NOMINAL LEAD LENGTH IS 1.250.

47

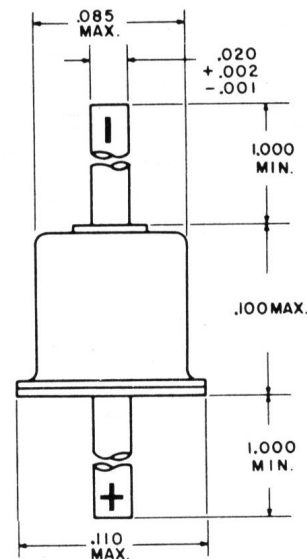

ALL DIMENSIONS IN INCHES. DIMENSIONS ARE REFERENCE UNLESS TOLERANCED.

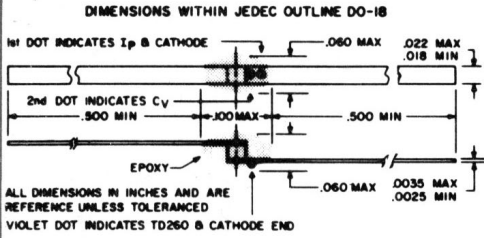

TD260 SERIES

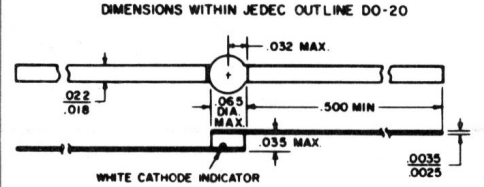

TD270 SERIES

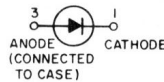
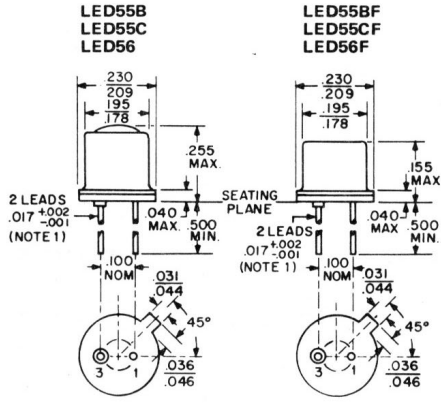
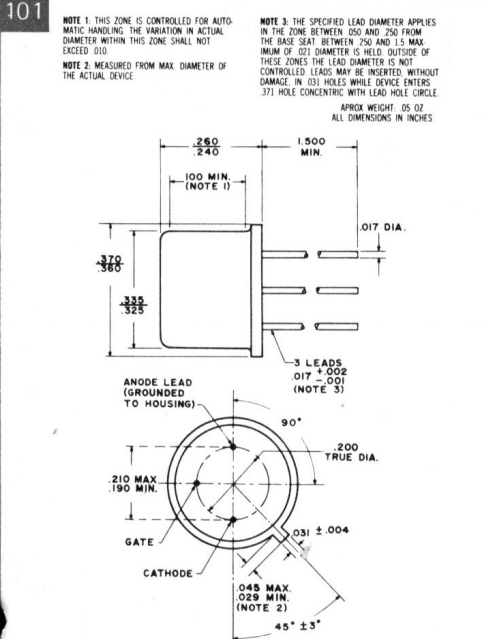

NOTE 1: LEAD DIAMETER IS CONTROLLED IN THE ZONE BETWEEN .050 AND .250 FROM THE SEATING PLANE. BETWEEN .250 AND END OF LEAD A MAX. OF .021 IS HELD.

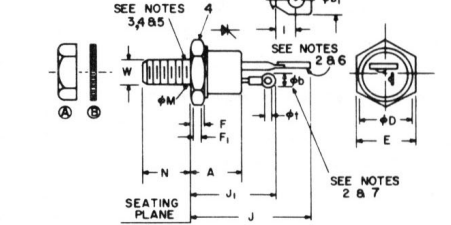
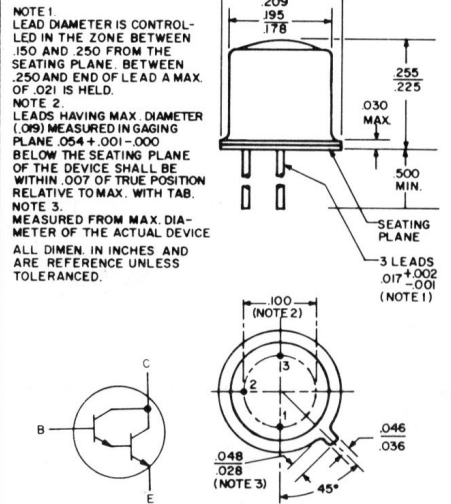

NOTES: 1. COMPLETE THREADS EXTEND TO WITHIN 2-1/2 THREADS OF HEAD. 2. DIAMETER OF UNTHREADED PORTION .190 MAX. 3. ANGULAR ORIENTATION OF THESE TERMINALS IS UNDEFINED. 4. CASE IS ANODE CONNECTION. 5. ALL DIMENSIONS IN INCHES.

- ① 10-32 STEEL NUT CADMIUM PLATED
- ② LOCKWASHER, CADMIUM PLATED STEEL

NOTES: 1. Complete threads to extend to within 2 1/2 threads of seating plane. Diameter of unthreaded portion .249" (6.32MM) Maximum, .220" (5.59MM) Minimum. 2. Angular orientation of these terminals is undefined. 3. 1/4-28 UNF-2A. Maximum pitch diameter of plated threads shall be basic pitch diameter. 2248" (5.76MM), minimum pitch diameter .2225" (5.66MM), reference screw thread standards for Federal Service 1957, Handbook H28, 1957, P1. 4. A chamfer (or undercut) on one or both ends of hexagonal portions is optional. 5. Case is anode connection. 6. Large terminal is cathode connection. 7. Small terminal is gate connection. 8. Insulating kit available upon request. A. 1/4-28 steel nut, Ni plated, 178 min. thk. B. Ext. tooth lockwasher, steel, Ni plated, 023 min. thk.

SYMBOL	INCHES		MILLIMETERS		NOTES
	MIN.	MAX.	MIN.	MAX.	
A	.330	.505	8.38	12.83	
gb	.115	.140	2.92	3.56	2
gb1	.210	.300	5.33	7.62	2
gd	.544		13.82		
E	.544	.562	13.82	14.27	
F	.113	.200	2.87	5.08	4
J	.060		1.52		
J1		1.193		30.30	
J2		.875		22.23	
J3	.120		3.05		
dm					1
N	.422	.453	10.72	11.51	
or	.060	.075	1.52	1.91	
o1	.125	.165	3.18	4.19	
w					3

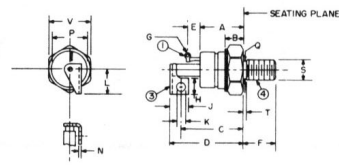

MODEL	TERMINAL ①	TERMINAL ③	TERMINAL ④	S THREAD SIZE
C152	GATE	CATHODE +	ANODE -	1/2-20 UNF-2A

- NOTES: 1. One nut and one lockwasher supplied with each unit. Material of hardware is steel, cad plated. 2. "T" dimension is area of unthreaded portion. Complete threads are within 2.5 threads of seating plane. 3. Angular orientation of terminals is undefined.

SYM	INCHES		METRIC MM		SYM	INCHES		METRIC MM		NOTES
	MIN	MAX	MIN	MAX		MIN	MAX	MIN	MAX	
A	1.020	1.140	25.90	28.96	L	.590	.640	14.98	16.26	
B	.390	.500	9.90	12.70						
C	1.460 REF	7.92 REF			N	.058	.070	1.47	1.78	
D	1.660	1.800	42.16	45.72						
E	.312 REF	7.92 REF			P	.840	.910	21.33	23.11	
F	.797	.827	20.24	21.01						
G	.060	.075	1.52	1.91	Q	.425	.499	10.79	12.67	
H	.385	.415	9.77	10.54	T	.060		1.52	2	
J	.445	.485	11.30	12.32	V	1.052	1.063	26.72	27.00	
K	.198	.212	5.02	5.38						

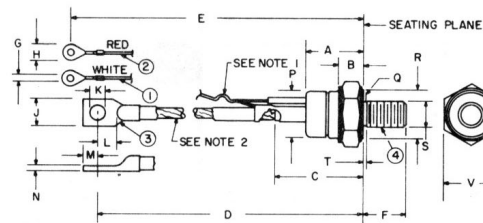

MODEL	TERMINAL ①	TERMINAL ②	TERMINAL ③	TERMINAL ④	S THREAD SIZE
C150	GATE	AUX CATHODE	CATHODE +	ANODE -	1/2 20UNF-2A

- NOTES: 1. Gate and auxiliary cathode leads supplied lightly twisted together. 2. Flexible copper lead. 3. One nut and one lockwasher supplied with each unit. Material of hardware is steel, cad plated. 4. "R" dimension is diameter of effective seating area. 5. "T" dimension is area of unthreaded portion. Complete threads are within 2.5 threads of seating plane. 6. Angular orientation of terminals is undefined.

108.1

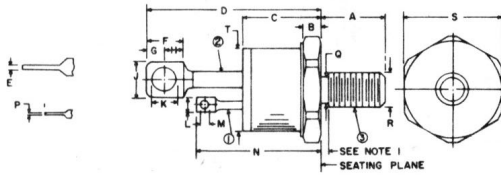

SYM	INCHES		METRIC M M		SYM	INCHES		METRIC M M	
	MIN.	MAX.	MIN.	MAX.		MIN.	MAX.	MIN.	MAX.
A	.422	.452	10.72	11.47	L	.090	.115	2.29	2.91
B	.120	.135	3.05	3.42	M	.055	.066	1.40	1.67
C	.534	.565	13.57	14.34	N	.831	.901	21.11	22.88
D	1.230	1.290	31.25	32.78	P	.012	—	.31	—
E	.029	.062	.74	1.56	Q	.220	—	.559	—
F	.258	REF	6.55	REF	S	.676	.684	17.18	17.36
G	.138	REF	3.50	REF	T	—	.597	—	15.15
H	.115	—	2.93	—	—	—	—	—	—
J	.240	.300	6.10	7.62	—	—	—	—	—
K	.169	.182	4.30	4.62	—	—	—	—	—

TERMINAL 1 GATE
TERMINAL 2 CATHODE
TERMINAL 3 ANODE
R THREAD SIZE 1/4-28 UNF-2A

NOTE: 1. COMPLETE THREADS TO WITHIN 1/2 THD OF SEATING PLANE.
2. ONE STEEL, CADMIUM PLATED NUT AND ONE STEEL, CADMIUM PLATED LOCKWASHER SUPPLIED WITH EACH DEVICE.

109.1

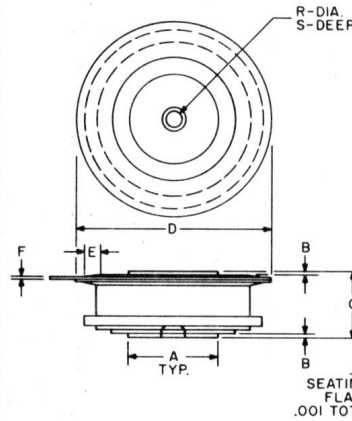
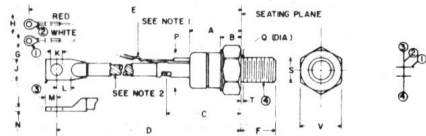

TABLE OF DIMENSIONS Conversion Table

SYM	DECIMAL INCHES		METRIC MM	
	MIN.	MAX.	MIN.	MAX.
A	.744	.752	18.897	19.101
B	.030	.060	.762	1.524
C	.515	.565	13.081	14.351
D	1.600	1.656	40.64	42.06
E	.110	—	2.794	—
F	.031	.017	.330	.432
R	.135	.145	3.429	3.683
S	.067	.083	1.701	2.108

110, 110.1



MODEL	TERMINAL 1	TERMINAL 2	TERMINAL 3	TERMINAL 4	S
C180 C185	GATE	AUX CATHODE	CATHODE	ANODE	—
C186	—	—	—	—	3/4-16 UNF-2A

NOTES:
1. Gate and auxiliary cathode leads supplied lightly twisted together.
2. Flexible copper lead.
3. One nut and one lockwasher supplied with each unit. Material of hardware is steel, cad plated.
4. "T" dimension is area of unthreaded portion. Complete threads are within 2.5 threads of seating plane.
5. Angular orientation of terminals is undefined.

SYM	INCHES		METRIC (MM)		NOTE	SYM	INCHES		METRIC (MM)		NOTE
	MIN.	MAX.	MIN.	MAX.			MIN.	MAX.	MIN.	MAX.	
A	1.450	1.550	36.83	39.37	—	L	.437	—	11.09	—	—
B	.500	.750	12.70	19.05	—	M	.325	.360	8.25	9.14	—
C	2.300	2.500	58.42	63.50	—	N	.093	.125	2.36	3.18	—
D	7.350	8.100	186.69	205.74	—	P	1.060	1.100	26.92	27.94	—
E	7.350	8.100	186.69	205.74	—	Q	.660	.749	16.76	19.02	—
F	1.047	1.077	26.59	27.36	—	—	—	—	—	—	—
G	.140	.150	3.55	3.81	—	T	—	.356	—	3.96	4
H	.215	.300	5.46	7.62	—	—	—	—	—	—	—
J	.530	.687	13.46	17.45	—	V	1.240	1.250	31.49	31.75	—
K	.322	.333	8.17	8.46	—	—	—	—	—	—	—

112

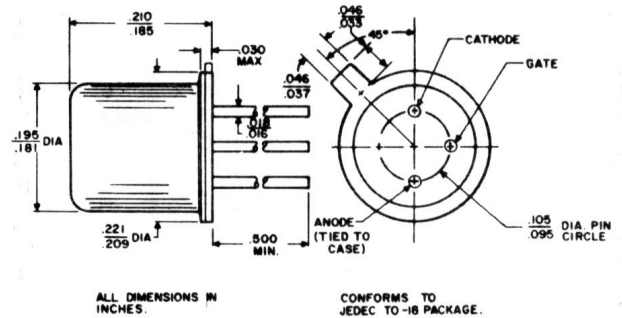

ALL DIMENSIONS IN INCHES.

CONFORMS TO JEDEC TO-18 PACKAGE.

119

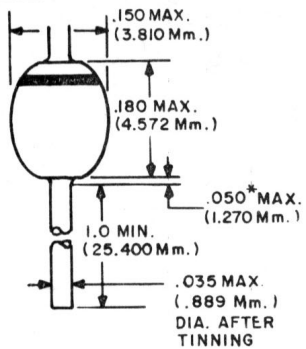

ALL DIMENSIONS ARE IN INCHES AND (METRIC)
* WELD AND SOLDER FLASH NOT CONTROLLED IN THIS AREA

119.2

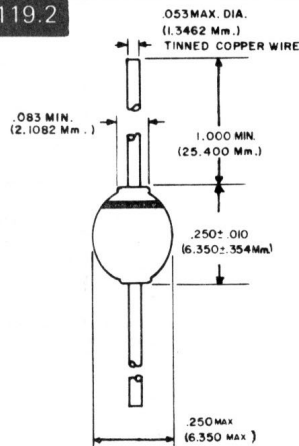

ALL DIMENSIONS ARE IN INCHES AND (METRIC)

120

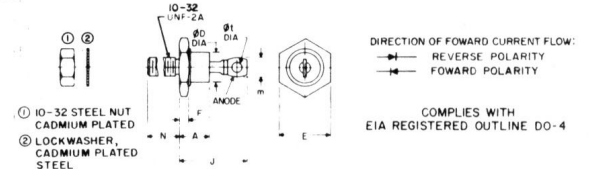

NOTES:
1. Angular orientation of this terminal is undefined.
2. 10-32 UNF-2A. Maximum pitch diameter of plated threads shall be basic pitch diameter (.1697", 4.29 MM). Ref. (Screw thread standards for Federal Services 1957) Handbook H28, P1

SYMBOL	INCHES		MILLIMETERS		NOTES
	MIN.	MAX.	MIN.	MAX.	
A	.405	.424	10.29	10.77	—
φD	.424	.437	10.77	11.10	—
E	.175	.175	4.45	4.45	—
F	.800	.800	20.32	20.32	—
J	.250	.250	6.35	6.35	1
m	.422	.453	10.72	11.51	—
φt	.060	.060	1.52	1.52	2
W	—	—	—	—	—

123

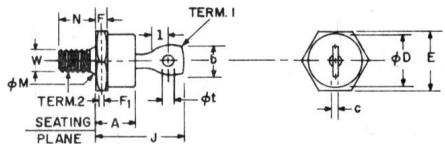

SYMBOL	INCHES		MILLIMETERS		NOTES
	MIN.	MAX.	MIN.	MAX.	
A	.450	.450	11.43	11.43	—
b	.375	.375	9.53	9.53	2
c	.080	.080	2.03	2.03	—
φD	.667	.667	16.94	16.94	—
E	.667	.687	16.94	17.45	—
F	.115	.200	2.92	5.08	—
F ₁	.060	.060	1.52	1.52	—
J	1.000	1.000	25.40	25.40	—
1	.156	.156	3.96	3.96	4
φM	.220	.249	5.59	6.32	1
N	.422	.453	10.72	11.51	—
φt	.140	.175	3.56	4.45	—
W	—	—	—	—	1,3

NOTES:
1. COMPLETE THREADS TO EXTEND TO WITHIN 2-1/2 THREADS OF SEATING PLANE.
2. ANGULAR ORIENTATION OF TERMINAL IS UNDEFINED.
3. 1/4-28 UNF-2A. MAXIMUM PITCH DIAMETER OF PLATED THREADS SHALL BE BASIC PITCH DIAMETER (.2268", 5.74 MM) REF. (SCREW THREAD STANDARDS FOR FEDERAL SERVICES 1957) HANDBOOK H28 1957 P1.
4. MINIMUM FLAT. EIA-NEMA STANDARD OUTLINE, NEMA SK-51-EIA RS-241. INSULATING HARDWARE IS AVAILABLE UPON REQUEST.
5. FOR REVERSE POLARITY TYPES ADD THE LETTER R, EXAMPLE: IN1183R.

125

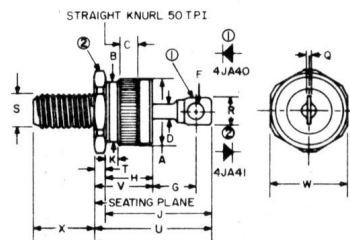

SYM	DECIMAL INCHES		METRIC MM	
	MIN.	MAX.	MIN.	MAX.
A	.501	.505	12.73	12.83
B	.467	.465	11.86	12.07
C	.177	REF	4.50	REF
D	.109	REF	2.77	REF
F	.104	.115	2.65	2.91
G	.285	.350	7.24	8.88
H	.330	.375	8.39	9.52
J	—	.810	—	20.56
K	.083	.097	2.11	2.46
Q	.034	REF	.86	REF
R	—	.250	—	6.34
S	THREAD SIZE-1/4"-28OUNF-2A			
T	.086	.098	2.18	2.49
U	—	.920	—	23.36
V	—	.485	—	12.31
W	.552	.562	14.02	14.27
X	.432	.442	10.97	11.23

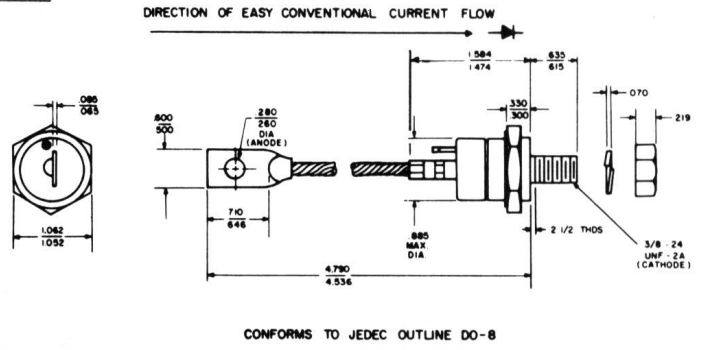
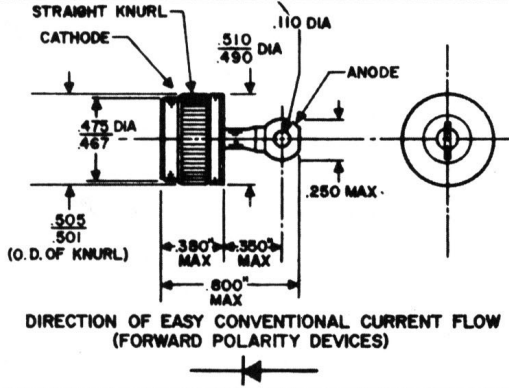

NOTE: FOR A170, A177 THE FOLLOWING DIM. APPLY.

D	4.345	4.745	110.36	120.52
J	.500	.625	12.70	13.20
K	.259	.281	6.57	7.14
N	.060	.090	1.52	2.29

TABLE OF DIMENSIONS Conversion Table

SYM.	DECIMAL INCHES		METRIC MM		NOTES
	MIN.	MAX.	MIN.	MAX.	
A	1.020	1.140	25.90	28.96	
B	.390	.500	9.90	12.70	
C	1.570	1.750	39.87	44.45	
D	4.750	5.150	120.65	130.81	
J	.520	.625	13.20	15.88	
K	.270	.291	6.85	7.39	
L	.320	—	8.12	—	
M	.280	.320	7.11	8.13	
N	.070	.110	1.77	2.79	
P	.840	.910	21.33	23.11	
T	.920	—	23.36	—	3
V	—	.060	—	1.52	4
V	1.052	1.063	26.72	27.00	

- NOTES:
1. Flexible Copper Lead, 9/32 Inch Nominal Diameter.
 2. One Nut and One Lockwasher Supplied With Each Unit. Material of Hardware is Steel Cad Plated.
 3. "R" Dimension is Diameter of Effective Seating Area.
 4. "T" Dimension is Area of Unthreaded Portion. Complete Threads are Within 2.5 Threads of Seating Plane.
 5. Angular Orientation of Terminals is Undefined.
 6. Approximate Weight: 105 Grams.

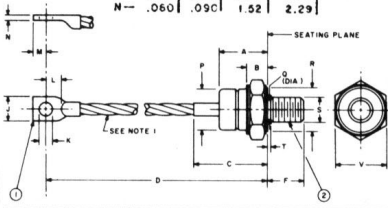

MODEL	TERMINAL 1	TERMINAL 2	S THREAD SIZE	F THREAD LENGTH	O RELIEF DIAMETER
FORWARD POLARITY	ANODE	CATHODE	3/8 - 24	.640 610 IN	.373 344 IN
REVERSE POLARITY	CATHODE	ANODE	UNF - 2A	16.26 MM 15.49 MM	9.47 MM 8.74 MM

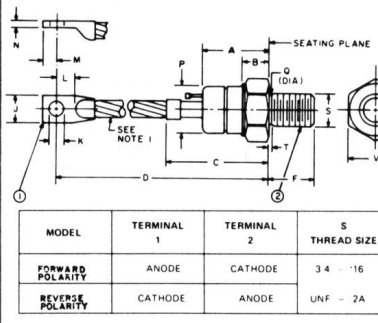

TABLE OF DIMENSIONS Conversion Table

SYM.	DECIMAL INCHES		METRIC MM		NOTES
	MIN.	MAX.	MIN.	MAX.	
A	1.450	1.550	36.83	39.37	
B	.500	.750	12.70	19.05	
C	2.300	2.500	58.42	63.50	
D	5.300	5.700	134.62	144.78	
F	.797	.827	20.24	21.01	
J	.665	.755	16.89	19.18	
K	.322	.333	8.17	8.46	
L	.437	—	11.99	—	
M	.325	.360	8.25	9.14	
N	.155	.170	—	—	
P	1.060	1.100	26.92	27.94	
Q	.660	.749	16.76	19.02	
T	—	.156	—	3.96	3
V	1.240	1.250	31.49	31.75	

- NOTES:
1. Flexible Copper Lead.
 2. One Nut and One Lockwasher Supplied With Each Unit. Material of Hardware is Steel Cad Plated.
 3. "T" Dimension is Area of Unthreaded Portion. Complete Threads are Within 2.5 Threads of Seating Plane.
 4. Angular Orientation of Terminals is Undefined.

C106 CONVERSIONS

INCHES	MILLIMETERS	INCHES	MILLIMETERS
.026	.660	.315	8.001
.019	.483	.285	7.239
.050	1.270	.320	8.128
.030	.761	.290	7.366
.054	1.372	.320	8.128
.046	1.168	.310	7.874
.070	1.778	.327	8.306
.105	2.667	.297	7.544
.095	2.412	.385	9.779
.127	3.226	.365	9.271
.123	3.124	.400	10.160
.135	3.429	.360	9.144
.115	2.920	.420	10.668
.190	4.826	.400	10.160
.170	4.318	.520	13.208
.260	6.604	.480	12.191
.240	6.095		
.272	6.908		
.232	5.892		

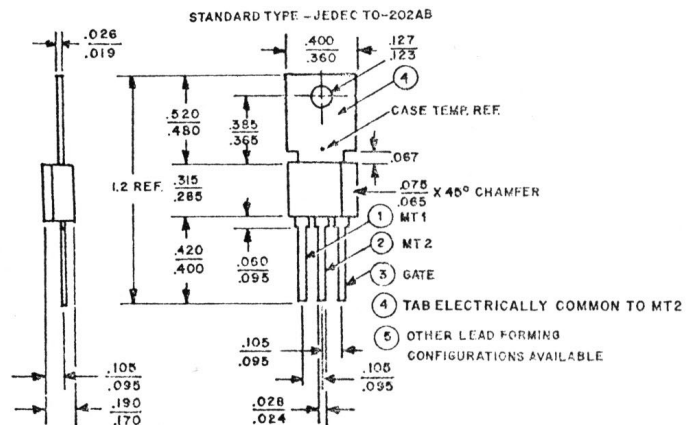
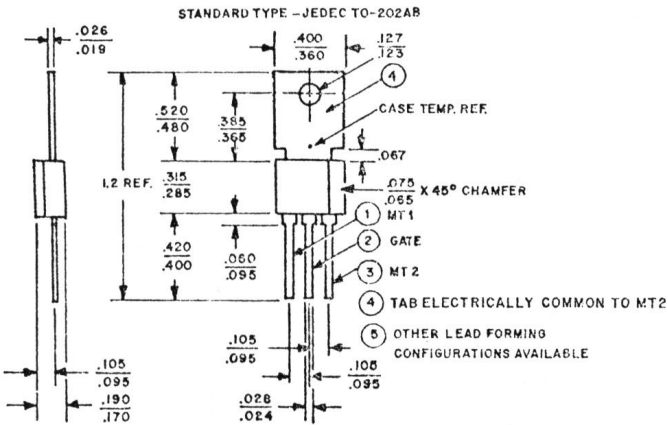
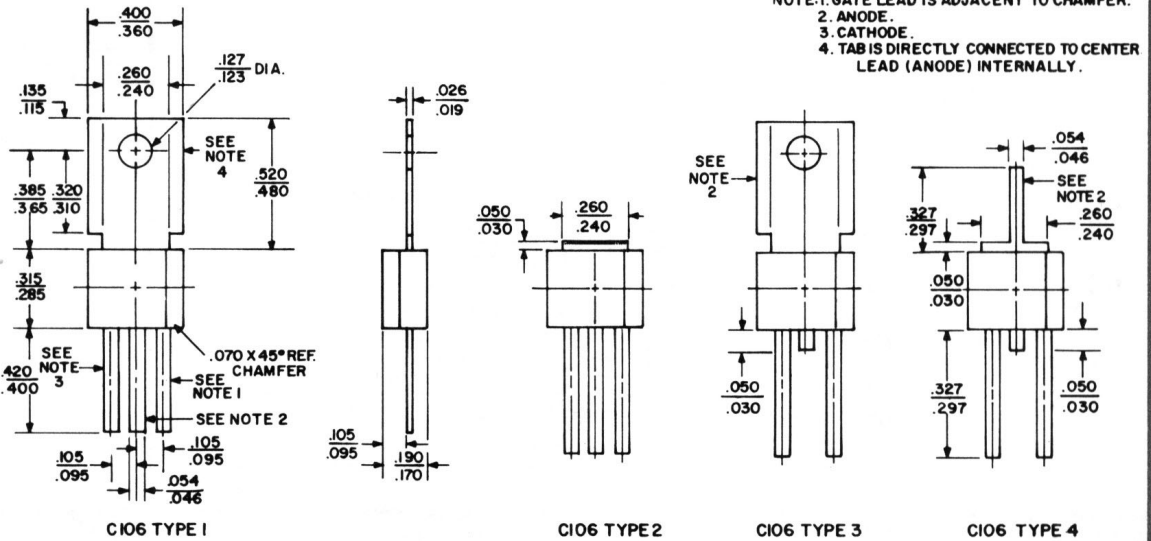

175

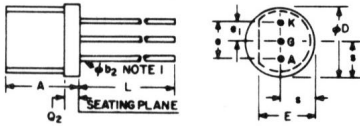

SYMBOL	INCHES		MILLIMETERS	
	MIN	MAX	MIN	MAX
A	.170	.265	4.32	6.73
φB ₂	.016	.019	406	483
D	.165	.205	4.19	5.21
E	.110	.155	2.79	3.94
e	.095	.105	2.41	2.67
e ₁	.045	.055	1.14	1.40
L	.500	—	12.70	—
Q ₂	—	.075	—	1.90
s	.080	.115	2.03	2.92

NOTE 1: LEAD DIAMETER IS CONTROLLED IN THE ZONE BETWEEN .070 AND .250 FROM THE SEATING PLANE BETWEEN .250 AND END OF LEAD A MAX OF .021 IS HELD.

182

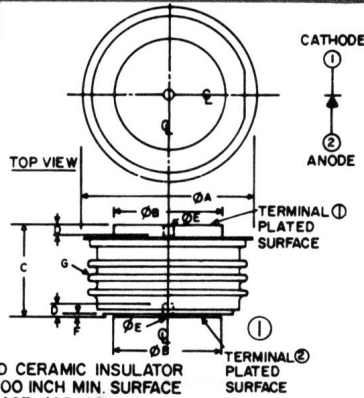

NOTE: 1. GLAZED CERAMIC INSULATOR WITH 1.00 INCH MIN. SURFACE CREEPAGE (25.40mm)

SYMBOL	INCHES		MILLIMETERS		NOTE
	MIN	MAX	MIN	MAX	
φA	—	2.000	—	50.80	
φB	1.240	1.260	31.50	32.00	
C	1.000	1.060	25.40	26.92	
D	.080	—	2.03	—	
φE	0.136	0.146	3.45	3.71	
F	.034	—	0.86	—	
G	—	—	—	—	1

183

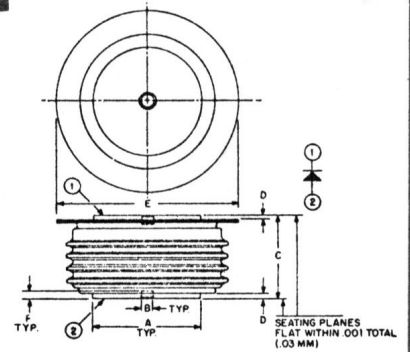

SYM	INCHES		METRIC MM	
	MIN	MAX	MIN	MAX
A	1.333	1.343	33.86	34.11
B	1.35	1.45	34.2	36.8
C	1.018	1.065	25.85	27.05
D	.030	.110	.76	—
E	2.240	2.300	56.89	58.42
F	.070	.090	3.55	4.06

185

NOTES:

1. Glazed Ceramic Insulator With 1.00 Inch Minimum Surface Creepage. (25.40 MM)

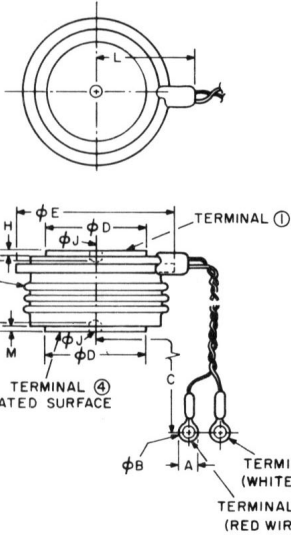
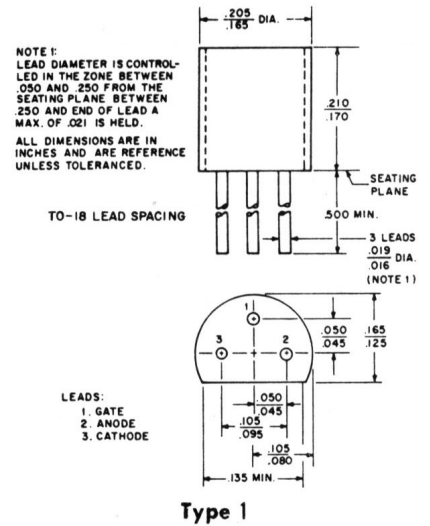

TABLE OF DIMENSIONS
Conversion Table

SYM.	DECIMAL INCHES		METRIC MM		NOTES
	MIN.	MAX.	MIN.	MAX.	
A	0.200	0.240	5.08	6.10	
φB	0.140	—	3.56	—	
C	16.000	20.000	406.40	508.00	
φD	1.240	1.260	31.50	32.00	
φE	—	2.000	—	50.80	
F	1.000	1.060	25.40	26.92	
G	—	—	—	—	1
H	.052	—	1.32	—	
φJ	0.136	0.146	3.45	3.71	
K	.080	—	2.03	—	
L	—	2.000	—	50.80	
M	.036	—	0.91	—	

195.1



NOTE 1: LEAD DIAMETER IS CONTROLLED IN THE ZONE BETWEEN .050 AND .250 FROM THE SEATING PLANE BETWEEN .250 AND END OF LEAD A MAX. OF .021 IS HELD. ALL DIMENSIONS ARE IN INCHES AND ARE REFERENCE UNLESS TOLERANCED.

Type 1

198, 198A

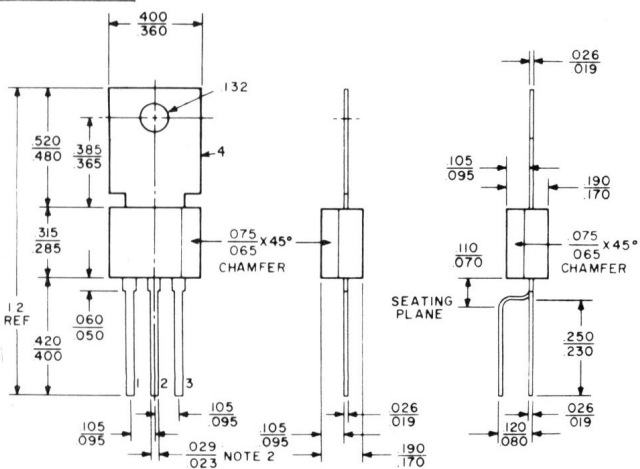

NOTES:

- ALL DIM. ARE IN INCHES AND ARE REF. UNLESS TOLERANCED.
- .043-.057 LEAD WIDTH WITHIN 0.100 OF BODY.

TYPE U
LEAD LABELS
1. EMITTER
2. BASE
3. COLLECTOR

228

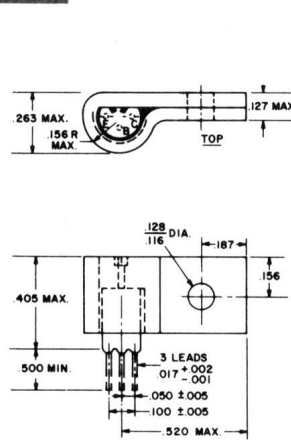

Type 2 (with P-Strap)

229

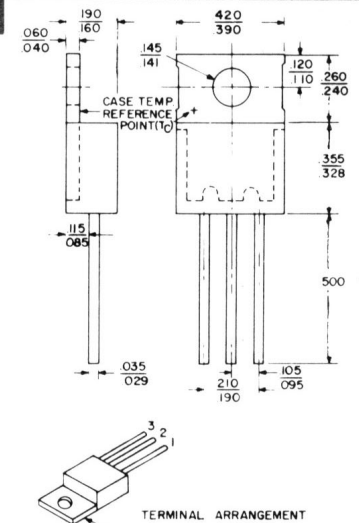

TERMINAL ARRANGEMENT
1. BASE
2. COLLECTOR
3. EMITTER
4. MOUNTING TAB (ELECTRICALLY COMMON TO COLLECTOR)

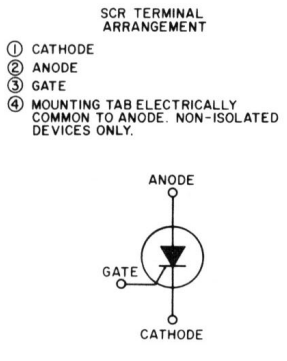
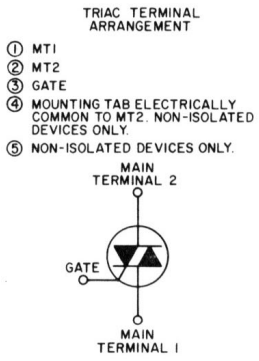
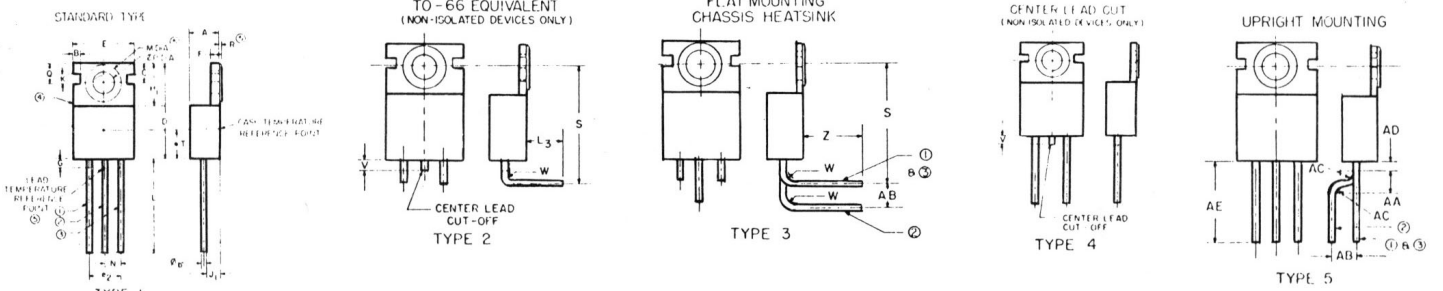

SYMBOL	INCHES		METRIC MM		SYMBOL	INCHES		METRIC MM	
	MIN	MAX	MIN	MAX		MIN	MAX	MIN	MAX
A	.160	.190	4.06	4.83	N	.095	1.05	2.41	2.67
B	.054 TYP.		1.37 TYP.		Ø P	.141	.145	3.58	3.68
Ø b	.029	.035	.73	.89	Q	.118 REF.		3.00 REF.	
C	.110	.120	2.79	3.05	R	.0015	.004	—	.10
D	.560	.650	14.23	16.51	S	.570	.590	14.47	14.99
E	.390	.420	9.90	10.67	T	—	.220	—	5.59
e ₂	.190	.210	4.82	5.33	V	.040	.070	1.01	1.78
F	.040	.055	1.01	1.39	W	.020	.030	.50	.76
G	—	.065	—	1.65	Z	.172	.202	4.36	5.13
H ₁	.240	.260	6.09	6.60	AA	.087	.097	2.20	2.46
J ₁	.085	.115	2.15	2.92	AB	.120	.130	3.04	3.30
K	.054 REF.		1.37 REF.		AC	.025	.035	.63	.89
L	.500	—	12.70	—	AD	.045	.055	1.14	1.40
L ₃	.360	—	9.14	—	AE	.353	.433	8.96	11.00
M	.232	.236	5.89	5.99					

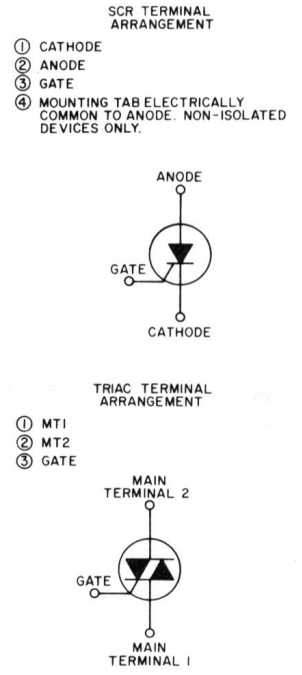
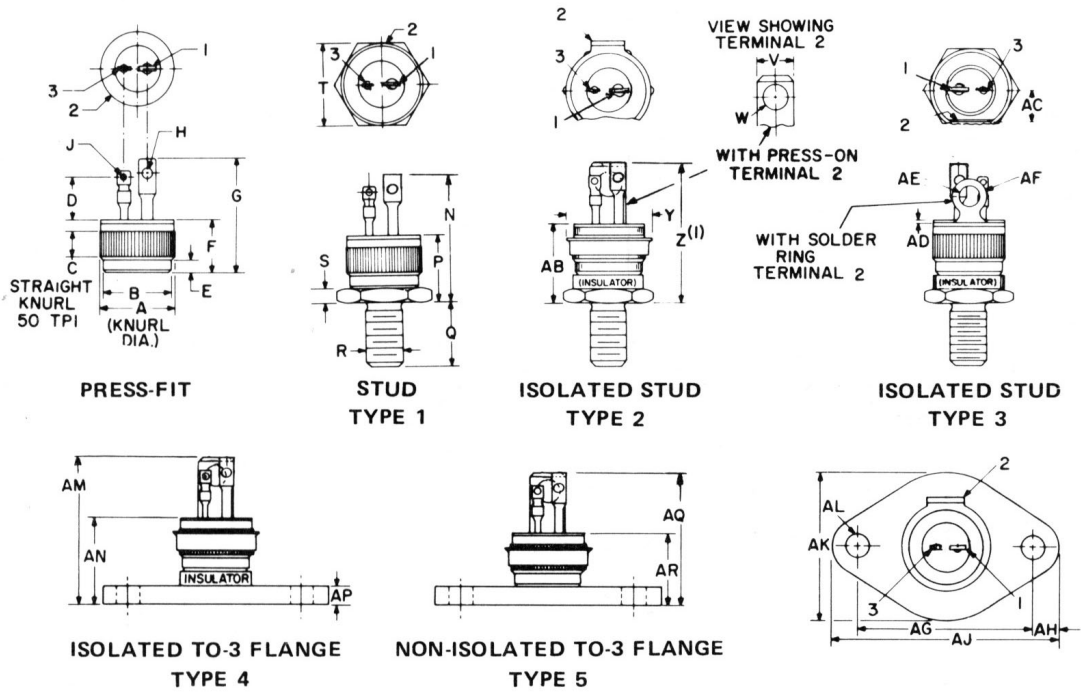

SYMBOL	INCHES		METRIC MM		SYMBOL	INCHES		METRIC MM	
	MIN	MAX	MIN	MAX		MIN	MAX	MIN	MAX
A	.501	.505	12.73	12.82	Y	.580	.610	14.74	15.49
B	.467	.475	11.87	12.06	Z	—	.978	—	24.84
C	.177 REF.		4.50 REF.		AB	—	.585	—	14.85
D	.260	.301	6.60	7.65	AC	.220 REF.		5.59 REF.	
E	.083	.097	2.11	2.46	AD	.012	.023	.31	.58
F	.340	.376	8.64	9.55	AE	.140	.150	3.56	3.81
G	—	.782	—	19.86	AF	.229	.251	5.82	6.37
H	.081	.089	2.06	2.26	AG	1.182	1.192	30.03	30.27
J	.060	.069	1.53	1.75	AH	.160	—	4.07	—
N	—	.868	—	22.04	AJ	1.507	1.567	38.28	39.80
P	—	.475	—	12.06	AK	.975	1.025	24.77	26.03
Q	.432	.442	10.98	11.22	AL	.150	.161	3.81	4.08
R(5)	1/4-28, UNF2A		—		AM	—	1.018	—	25.92
S	.086	.098	2.19	2.48	AN	—	.630	—	16.00
T	.552	.562	14.03	14.27	AP	.119	.131	3.03	3.32
V	.240	.260	6.10	6.60	AQ	—	.913	—	23.25
W	.145	.160	3.68	4.06	AR	—	.515	—	13.08

- NOTES:**
- Case temperature is measured for press-fit devices at the center of the base; for stud types 1, 2 and 3 at the center of any hex flat; for TO-3 outline mounting flange types 4 and 5 at the center of the bottom of the flange.
 - One external tooth lock washer and one nut (both steel, cadmium plated) are supplied with each stud and isolated stud unit.
 - Insulation hardware for stud devices consisting of solder terminal, mica washers and one nylon bushing are available at extra cost upon request.
 - Other standard package variations are available upon request.
 - Metric stud 8mm x 1.25 (.315 in. x .049 in.) is available upon request.

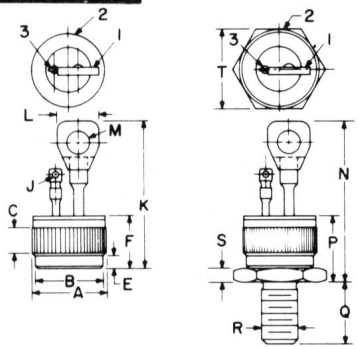

PRESS-FIT

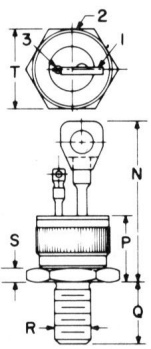

STUD TYPE 1

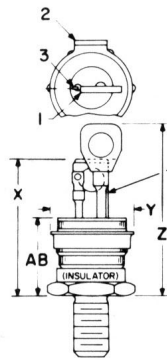

ISOLATED STUD TYPE 2

VIEW SHOWING TERMINAL 2

WITH PRESS-ON TERMINAL 2

WITH SOLDER RING TERMINAL 2

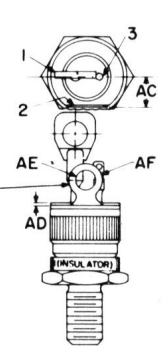

ISOLATED STUD TYPE 3

- SCR TERMINAL ARRANGEMENT
- ① CATHODE
 - ② ANODE
 - ③ GATE
 - ④ MOUNTING TAB ELECTRICALLY COMMON TO ANODE. NON-ISOLATED DEVICES ONLY.

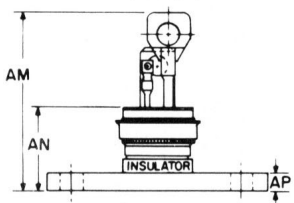
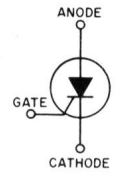

ISOLATED TO-3 FLANGE TYPE 4

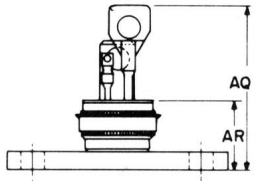

NON-ISOLATED TO-3 FLANGE TYPE 5

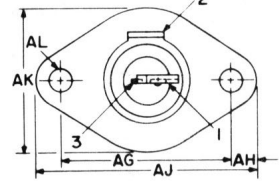

- TRIAC TERMINAL ARRANGEMENT
- ① MT1
 - ② MT2
 - ③ GATE

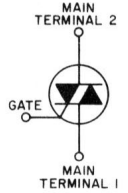

SYMBOL	INCHES		METRIC MM	
	MIN.	MAX.	MIN.	MAX.
A	.501	.505	12.73	12.82
B	.467	.475	11.87	12.06
C	.177 REF		4.50 REF	
D	.260	.301	6.60	7.65
E	.083	.097	2.11	2.46
F	.340	.376	8.64	9.55
G	—	.782	—	19.86
H	.081	.089	2.06	2.26
J	.060	.069	1.53	1.75
K	—	1.064	—	27.02
L	.284	.302	7.22	7.67
M	.146	.160	3.71	4.06
N	—	1.150	—	29.21
P	—	.475	—	12.06
Q	.432	.442	10.98	11.22
R(5)	1/4-28, UNF2A			
S	.086	.098	2.19	2.48
T	.552	.562	14.03	14.27
V	.240	.260	6.10	6.60
W	.145	.160	3.68	4.06

SYMBOL	INCHES		METRIC MM	
	MIN.	MAX.	MIN.	MAX.
X	—	.975	—	24.76
Y	.580	.610	14.74	15.49
Z	—	1.260	—	32.00
AB	—	.585	—	14.85
AC	.220 REF		5.59 REF	
AD	.012	.023	.31	.58
AE	.140	.150	3.56	3.81
AF	.229	.251	5.82	6.37
AG	1.182	1.192	30.03	30.27
AH	.160	—	4.07	—
AJ	1.507	1.567	38.28	39.80
AK	.975	1.025	24.77	26.03
AL	.150	.161	3.81	4.08
AM	—	1.300	—	33.02
AN	—	.630	—	16.00
AP	.119	.131	3.03	3.32
AQ	—	1.195	—	30.35
AR	—	.515	—	13.08

NOTES:

1. Case temperature is measured for press-fit devices at the center of the base; for stud types 1, 2 and 3 at the center of any hex flat; for TO-3 outline mounting flange types 4 and 5 at the center of the bottom of the flange.
2. One external tooth lock washer and one nut (both steel, cadmium plated) are supplied with each stud and isolated stud unit.
3. Insulation hardware for stud devices consisting of solder terminal, mica washers and one nylon bushing are available at extra cost upon request.
4. Other standard package variations are available upon request.
5. Metric stud 8mm x 1.25 (.315 in. x .049 in.) is available upon request.

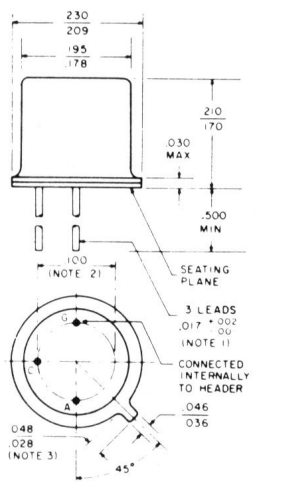

DIMENSIONS WITHIN JEDEC OUTLINE TO-18

- NOTE 1: Lead diameter is controlled in the zone between .050 and .250 from the seating plane. Between .250 and end of lead a max of .021 is held.
- NOTE 2: Leads having maximum diameter (.019) measured in gaging plane (.054 + .001) — .000 below the seating plane of the device shall be within .007 of true position relative to a maximum width tab.
- NOTE 3: Measured from max. diameter of the actual device.

ALL DIMEN IN INCHES AND ARE REFERENCE UNLESS TOLERANCED

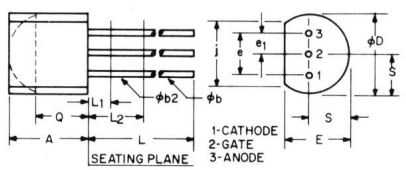

NOTES:

1. THREE LEADS.
2. CONTOUR OF THE PACKAGE BEYOND THIS ZONE IS UNCONTROLLED.
3. (THREE LEADS) phi b2 APPLIES BETWEEN L1 AND L2. phi b APPLIES BETWEEN L2 AND .5 INCH (12.70 MM) FROM SEATING PLANE. DIAMETER IS UNCONTROLLED IN L1 AND BEYOND .5 INCH (12.70 MM) FROM SEATING PLANE.

SYMBOL	INCHES		MILLIMETERS		NOTES
	MIN.	MAX.	MIN.	MAX.	
A	.170	.210	4.58	5.33	
phi b	.016	.021	.407	.533	1,3
phi b2	.016	.019	.407	.482	3
phi D	.175	.205	4.96	5.20	
E	.125	.165	3.94	4.19	
e	.095	.105	2.42	2.66	
e1	.045	.055	1.15	1.39	
J	.135	—	3.43	—	
L	.500	—	12.70	—	1,3
L1	—	.050	—	1.27	3
L2	.250	—	6.35	—	3
Q	.115	—	2.93	—	2
S	.080	.105	2.42	2.66	

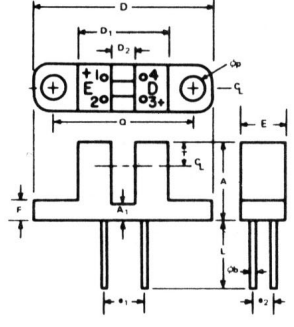

NOTES:

1. Four leads. Lead diameter controlled between .050" (1.27 MM) from the seating plane and the end of the leads.
2. The sensing area falls within a .060" (1.52 MM) square on this centerline.

SYMBOL	INCHES		MILLIMETERS		NOTES
	MIN.	MAX.	MIN.	MAX.	
A	.390	.400	9.91	10.16	
A1	.075	.085	1.91	2.15	
phi b	.016	.019	.407	.482	1
D	.954	.984	24.24	24.99	
D1	.475	.495	12.07	12.57	
D2	.120	.130	3.05	3.30	
e1	.206	.235	5.21	5.96	
e2	.090	.110	2.29	2.79	
E	.250	—	6.35	—	
F	.095	.105	2.42	2.66	
L	.300	—	7.62	—	1
phi p	.120	.130	3.05	3.30	
Q	.745	.755	18.93	19.17	
T	.110 NOM.	—	2.79 NOM.	—	2

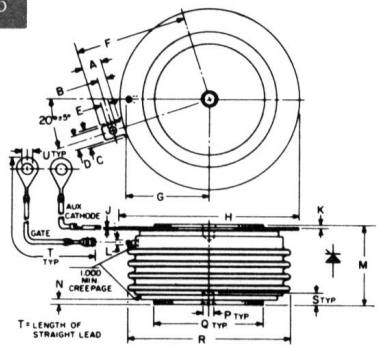

SYM	DECIMAL INCHES		METRIC		SYM	DECIMAL INCHES		METRIC	
	MIN.	MAX.	MIN.	MAX.		MIN.	MAX.	MIN.	MAX.
A	.240	.260	6.096	6.604	L	.056	.060	1.422	1.524
B	.110	.130	2.794	3.302	M	1.000	1.065	25.40	27.05
C	.245	—	6.223	—	N	.030	.096	.762	2.438
D	.186	.191	4.724	4.851	P	.130	.150	3.302	3.810
E	.060	.075	1.524	1.905	Q	1.300	1.345	33.02	34.16
F	—	1.430	—	36.32	R	—	2.150	—	54.61
G	—	1.065	—	27.051	S	.067	.083	1.702	2.11
H	2.200	2.500	55.88	63.50	T	12.200	12.360	309.9	313.9
J	.011	.019	2.794	3.483	U	.137	.153	3.480	3.886
K	.030	.130	.762	3.302					

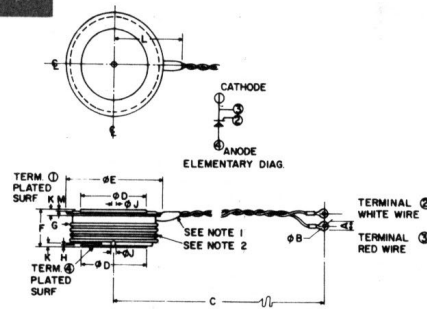

SYMBOL	INCHES		MILLIMETERS		NOTES
	MIN.	MAX.	MIN.	MAX.	
A	0.200	0.240	5.08	6.10	1
ΦB	0.140	—	3.56	—	
C	16.000	20.000	406.40	508.00	
ΦD	1.700	1.900	43.18	48.26	
ΦE	—	2.960	—	75.18	
F	1.000	1.070	25.40	27.18	
G	—	—	—	—	2
H	.005	.067	.013	1.70	
ΦJ	0.136	0.146	3.45	3.71	
K	.070	—	1.78	—	
L	—	2.500	—	63.50	
M	.030	—	0.76	—	

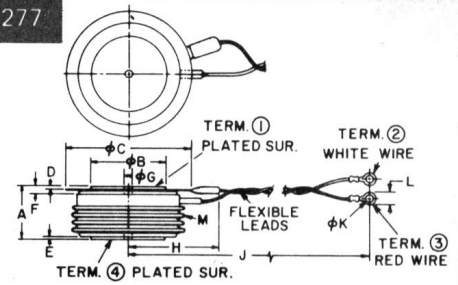

- NOTES:
 1. CONTOUR AND ORIENTATION OF TERMINAL LUGS IS UNDEFINED.
 2. GLAZED CERAMIC INSULATOR WITH 1.00 INCH (25.40MM) SURFACE CREEPAGE, MIN.

SYM.	INCHES		MILLIMETERS		NOTES
	MIN.	MAX.	MIN.	MAX.	
A	0.990	1.040	25.15	26.42	
ΦB	1.350	1.350	33.78	34.29	
ΦC	—	2.280	—	57.91	
D	0.040	0.090	1.02	2.29	
E	0.005	0.090	0.13	2.29	
F	0.070	—	1.78	—	
ΦG	0.136	0.146	3.45	3.71	
H	—	2.000	—	50.80	
J	18.000	20.000	457.20	508.00	
ΦK	0.140	—	3.56	—	1
L	0.200	0.240	5.08	6.10	1
M	—	—	—	—	2

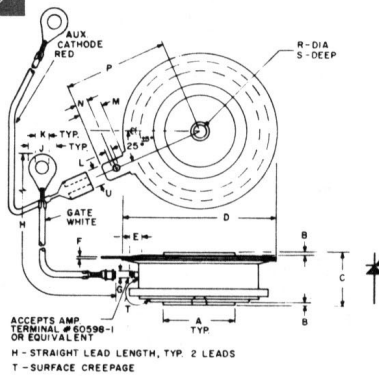
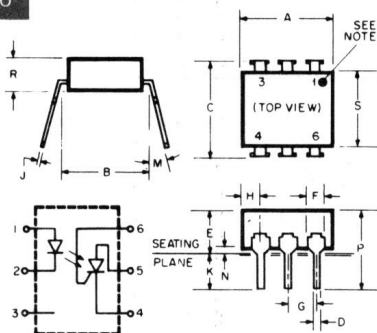

TABLE OF DIMENSIONS
Conversion Table

SYM	DECIMAL INCHES		METRIC MM.	
	MIN.	MAX.	MIN.	MAX.
A	.744	.752	18.897	19.101
B	.030	.060	.762	1.524
C	.515	.565	13.081	14.351
D	1.600	1.656	40.64	42.06
E	.110	—	2.794	—
F	.031	.017	.330	.432
G	.057	.059	1.447	1.499
H	7.980	8.115	202.70	206.11
J	—	.300	—	7.620
K	.137	.153	3.479	3.886
L	.065	.070	1.651	1.778
M	.245	.260	6.223	6.604
N	.120	.140	3.048	3.556
P	.1090	.1125	27.69	28.55
R	.135	.145	3.429	3.683
S	.067	.083	1.701	2.108
T	.340	—	8.636	—
U	.186	.189	4.724	4.801



SYMBOL	INCH		MILLIMETER		NOTES
	MIN.	MAX.	MIN.	MAX.	
A	.350	.350	8.89	8.89	
B	.300	REF	7.62	REF	2
C	.340	—	8.64	—	3
D	.016	.020	.406	.508	
E	.040	0.070	1.01	1.78	4
F	.090	.110	2.28	2.79	
G	—	.085	—	2.16	5
H	.008	.012	.203	.305	
J	.100	—	2.54	—	3
K	—	1.5°	—	1.5°	
N	.015	—	.381	—	3
P	—	.375	—	9.53	
R	.100	.185	2.54	4.70	
S	.225	.280	5.71	7.12	

- NOTES:
 1. There shall be a permanent indication of terminal orientation in the quadrant adjacent to terminal 1.
 2. Installed position lead centers.
 3. Overall installed dimension.
 4. These measurements are made from the seating plane.
 5. Four places.

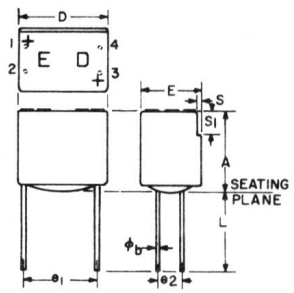

SYMBOL	INCHES		MILLIMETERS		NOTES
	MIN.	MAX.	MIN.	MAX.	
A	.350	—	8.89	—	
ΦB	.016	.019	.407	.482	1
D	—	.375	—	9.52	
Φ1	.285	.315	7.24	8.00	
Φ2	.090	.110	2.29	2.79	
E	—	.250	—	6.35	
L	.300	—	7.62	—	1
S	.010	.020	.26	.50	
S1	.085	.105	2.16	2.66	

- NOTES:
 1. FOUR LEADS. LEAD DIAMETER CONTROLLED BETWEEN .050" (1.27MM) FROM THE SEATING PLANE AND THE END OF THE LEADS.

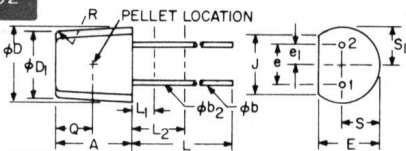

- NOTES:
 1. (TWO LEADS) Φb2 APPLIES BETWEEN L1 AND L2. Φb APPLIES BETWEEN L2 AND 5" (12.7MM) FROM SEATING PLANE. DIAMETER IS UNCONTROLLED IN L1 AND BEYOND. 5" (12.7MM) FROM SEATING PLANE.
 2. THE CENTER LINE OF THE ACTIVE ELEMENT IS LOCATED WITHIN ±.020" (.51 MM) OF THE POSITION SHOWN.
 3. AS MEASURED WITHIN .050" (1.27MM) OF THE SEATING PLANE

SYMBOL	INCHES		MILLIMETERS		NOTES
	MIN.	MAX.	MIN.	MAX.	
A	.170	.210	4.31	5.34	
Φb	.016	.021	.406	.534	1
Φb2	.016	.019	.406	.483	
ΦD	.170	.200	4.31	5.08	
ΦE	.160	.190	4.06	4.83	
D	.125	.155	3.17	3.94	
e	.095	.105	2.41	2.67	3
e1	.045	.055	1.14	1.40	3
J	.135	.170	3.42	4.32	
L	.500	—	12.70	—	1
L1	—	.050	—	1.27	1
L2	.250	—	6.35	—	1
Q	.095	REF.	2.29	REF.	2
R	.055	—	.12	—	
S	.080	.105	2.03	2.67	
S1	.090	REF.	2.29	REF.	

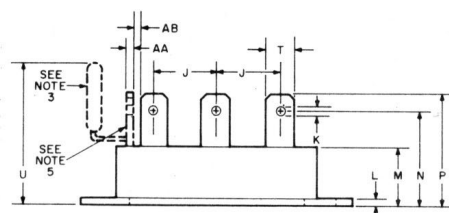
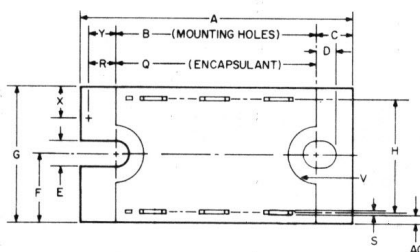

- NOTES:
 1. TERMINALS WILL ACCEPT .250 SERIES FAST-ON CONNECTORS.
 2. VIEW SHOWS TYPICAL LOCATIONS. SEE CIRCUIT SCHEMATICS AND TERMINAL POSITIONS FOR NUMBER OF TERMINALS AND THEIR LOCATIONS FOR SPECIFIC MODEL.
 3. U DIMENSION SHOW MAXIMUM HEIGHT OF VARISTOR. VIEW ONLY SHOWS TYPICAL LOCATION. VARISTOR APPEARS ONLY ON MODELS BEGINNING WITH LETTERS WV.
 4. POINTS (X-Y) ARE FOR THERMOCOUPLE PLACEMENT FOR BASE PLATE TEMPERATURE MEASUREMENT.
 5. TABS SHOWN ATTACHED TO AC TERMINALS ARE INTENDED FOR GE-MOV² VARISTOR ATTACHMENT.

SYM	INCHES		METRIC MM		NOTES
	MIN.	MAX.	MIN.	MAX.	
A	2.485	2.515	63.12	63.88	
B	1.890	1.910	48.01	48.51	
C	.290	.310	7.37	7.87	
D	.155	—	.394	—	
E	.200	.215	5.08	5.46	
F	.620	.630	15.75	16.00	
G	1.240	1.260	30.50	32.00	
H	1.07	REF	27.18	REF.	
J	.630	.660	15.87	16.76	
K	.057	.067	1.45	1.70	
L	.055	.070	1.40	1.78	
M	.523	.550	13.28	13.97	
N	.800	.850	20.32	21.59	
P	.965	1.025	24.51	26.04	
Q	—	.1915	—	.4864	
R	.285	—	.723	—	
S	.027	.037	.69	.94	
T	.245	.255	6.22	6.48	1 & 2
U	—	1.550	—	39.37	3
V	.230	—	.584	—	
X	—	.310	—	7.37	4
Y	—	.235	—	5.97	4
AA	.065	.085	1.65	2.16	
AB	.040	—	1.02	—	

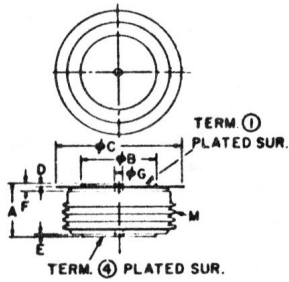

NOTES:
I. GLAZED CERAMIC INSULATOR WITH 1.00 INCH (25.40MM) SURFACE CREEPAGE, MIN.

SYM.	INCHES	MILLIMETERS	NOTES
	MIN.	MAX.	
A	0.990	1.040	25.15 26.42
φB	1.330	1.350	33.78 34.29
φC	—	2.280	57.91
D	0.040	0.090	1.02 2.29
E	0.005	0.090	0.13 2.29
F	0.070	—	1.78
φG	0.136	0.146	3.45 3.71

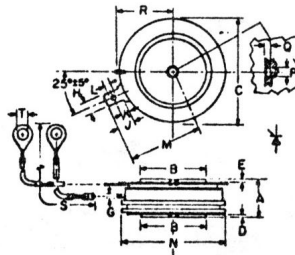

SYM.	INCHES		METRIC -MM	
	MIN.	MAX.	MIN.	MAX.
A	.560	.605	14.22	15.37
B	.985	.995	25.01	25.27
C	1.600	1.650	40.64	41.91
D	.030	—	.76	—
E	.040	—	1.01	—
G	.057	.059	1.44	1.50
H	.186	.191	4.72	4.85
J	.245	.255	6.22	6.48
K	.115	.130	2.92	3.30
L	.064	.070	1.62	1.78
M	—	1.120	—	28.45
N	—	1.585	—	40.26
P	.135	.145	3.42	3.68
Q	.070	.080	1.77	2.01
R	—	.875	—	22.23
S	1.219	1.2343	31.036	31.351
T	.137	.151	3.47	3.87

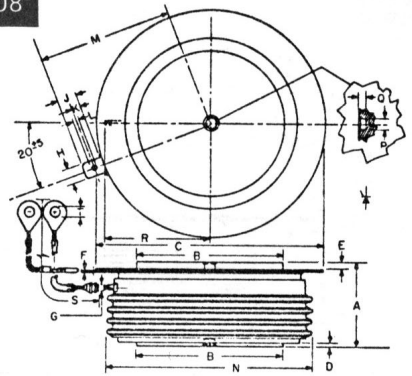

GENERAL (APPLIES TO ALL PARTS)				
SYM.	INCHES	MILLIMETERS	NOTES	
	MIN.	MAX.		
A	1.020	1.045	25.90 26.55	
B	1.845	1.955	46.86 49.72	
C	—	2.940	— 74.68	
D	.030	—	.76	
E	.050	—	1.27	
F	.017	.023	.43 .57	
G	.057	.059	1.44 1.50	
H	.186	.191	4.72 4.85	
J	.245	.255	6.22 6.48	
K	.115	.130	2.92 3.30	
L	.064	.070	1.62 1.78	
M	—	1.740	— 44.20	
N	—	2.650	— 67.31	
P	.135	.145	3.42 3.69	
Q	.070	.082	1.77 2.04	
R	—	1.355	— 34.42	
S	1.219	1.2343	31.036 31.351	
T	.137	.153	3.47 3.89	

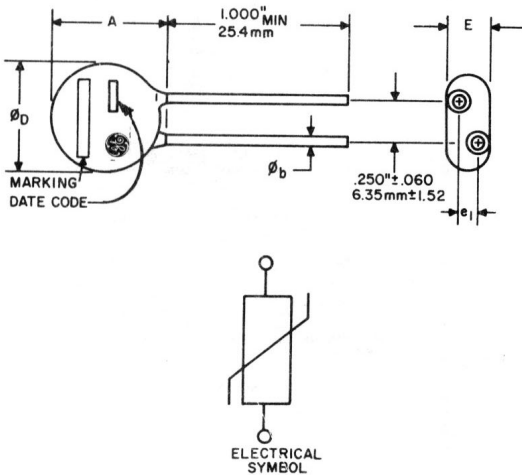

MODEL NUMBER	MARKING	A		φD		E		e ₁		φ _b					
		MAX.		MAX.		MAX.		MIN.		MAX.					
		IN	MM	IN	MM	IN	MM	IN	MM	IN	MM				
V182A1	1821	.461	11.7	.335	8.51	.158	4.0	.038	0.98	.079	2.0	.023	.59	.027	.68
V182A3	V182A3	.745	16.9	.636	16.15	.173	4.4	.043	1.09	.079	2.0	.030	.77	.034	.86
V222A1	2221	.461	11.7	.335	8.51	.158	4.0	.038	0.98	.079	2.0	.023	.59	.027	.68
V222A3	V222A3	.745	16.9	.636	16.15	.173	4.4	.043	1.09	.079	2.0	.030	.77	.034	.86
V242A1	2421	.461	11.7	.315	8.51	.158	4.0	.038	0.98	.079	2.0	.023	.59	.027	.68
V242A4	V242A4	.745	18.9	.636	16.15	.173	4.4	.043	1.09	.079	2.0	.030	.77	.034	.86
V272A1	2721	.461	11.7	.335	8.51	.158	4.0	.038	0.98	.079	2.0	.023	.59	.027	.68
V272A4	V272A4	.745	18.9	.636	16.15	.197	5.0	.054	1.36	.099	2.5	.030	.77	.034	.86
V332A1	3321	.461	11.7	.335	8.51	.158	4.0	.038	0.98	.079	2.0	.023	.59	.027	.68
V332A5	V332A5	.745	18.9	.636	16.15	.197	5.0	.054	1.36	.099	2.5	.030	.77	.034	.86
V392A1	3921	.461	11.7	.335	8.51	.178	4.5	.048	1.24	.099	2.5	.023	.59	.027	.68
V392A6	V392A6	.745	18.9	.636	16.15	.197	5.0	.054	1.36	.099	2.5	.030	.77	.034	.86
V472A1	4721	.461	11.7	.335	8.51	.197	5.0	.059	1.50	.119	3.0	.023	.59	.027	.68
V472A7	V472A7	.745	18.9	.636	16.15	.212	5.4	.065	1.63	.119	3.0	.030	.77	.034	.86
V562A2	5622	.461	11.7	.335	8.51	.197	5.0	.059	1.50	.119	3.0	.023	.59	.027	.68
V562A8	V562A8	.745	18.9	.636	16.15	.237	6.0	.075	1.90	.138	3.5	.030	.77	.034	.86
V682A2	6822	.461	11.7	.335	8.51	.217	5.5	.068	1.75	.138	3.5	.023	.59	.027	.68
V682A10	V682A10	.745	18.9	.636	16.15	.251	6.4	.086	2.17	.158	4.0	.030	.77	.034	.86
V822A2	8222	.461	11.7	.335	8.51	.237	6.0	.079	2.01	.158	4.0	.023	.59	.027	.68
V822A12	V822A12	.745	18.9	.636	16.15	.275	7.0	.097	2.44	.178	4.5	.030	.77	.034	.86
V1002A3	1002	.461	11.7	.335	8.51	.256	6.5	.089	2.27	.178	4.5	.023	.59	.027	.68
V1002A15	V1002A15	.745	18.9	.636	16.15	.291	7.4	.107	2.71	.197	5.0	.030	.77	.034	.86
V1202A1	1202	.461	11.7	.335	8.51	.158	4.0	.038	0.98	.079	2.0	.023	.59	.027	.68
V1202A6	V1202A6	.745	18.9	.636	16.15	.197	5.0	.059	1.36	.099	2.5	.030	.77	.034	.86
V1502A1	1502	.461	11.7	.335	8.51	.178	4.5	.048	1.24	.099	2.5	.023	.59	.027	.68
V1502A8	V1502A8	.745	18.9	.636	16.15	.197	5.0	.054	1.36	.099	2.5	.030	.77	.034	.86
V1802A1	1802	.461	11.7	.335	8.51	.178	4.5	.048	1.24	.099	2.5	.023	.59	.027	.68
V1802A10	V1802A10	.745	18.9	.636	16.15	.212	5.4	.065	1.63	.119	3.0	.030	.77	.034	.86

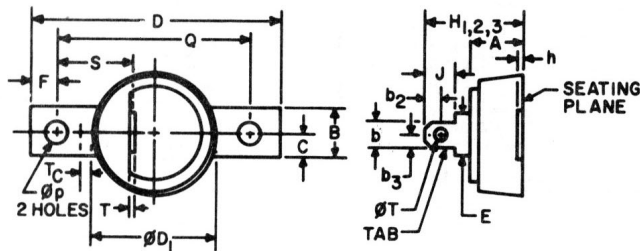

Notes:
1. Tab is designed to fit 1/4" quick connect terminal.
2. Case temperature is measured at T_c on top surface of base plate.
3. H₁ (130-150VRMS devices)
H₂ (250-320VRMS devices)
H₃ (420-575VRMS devices)
4. Electrical connection: top terminal and base plate.

SYM	INCHES			MILLIMETERS			NOTES
	Min.	Nom.	Max.	Min.	Nom.	Max.	
A	—	—	.57	—	—	14.3	—
b	—	—	.26	—	—	6.6	1
b ₂	—	.16	—	—	4.1	—	—
b ₃	—	.13	—	—	3.2	—	—
B	—	—	.51	—	—	12.9	—
C	—	—	.26	—	—	6.5	—
D	—	—	2.61	—	—	66.2	—
φD ₁	—	—	1.32	—	—	33.5	—
E	—	.44	—	—	11.2	—	—
F	—	.30	—	—	7.7	—	—
h	—	.03	—	—	.8	.9	—
H ₁	.91	—	1.01	23.2	—	25.5	3
H ₂	.96	—	1.12	24.6	—	28.3	3
H ₃	1.03	—	1.29	26.3	—	32.6	3
J	—	—	.32	—	—	8.1	—
φQ	.22	—	.24	5.8	—	6.0	—
Q	1.99	2.00	2.01	50.6	50.8	51.0	—
S	—	.76	—	—	19.2	—	—
T	—	—	.04	—	—	1.0	1
φT	.11	—	—	2.8	—	—	—
T _c	—	.13	—	—	3.2	—	2

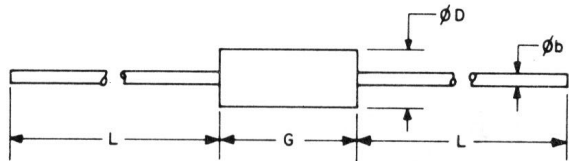

SYM	MM		IN	
	Min.	Max.	Min.	Max.
φb	.79	.83	.031	.033
φD	3.43	3.68	.135	.145
G	8.01	8.50	.315	.335
L	26.0	29.0	1.03	1.14

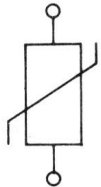

OUTLINE DRAWING SIZE 1

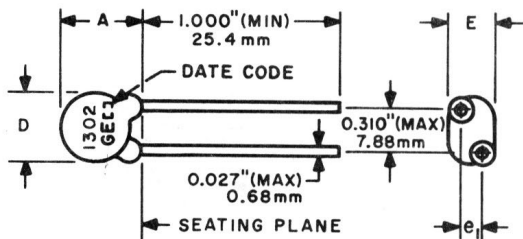

DIMENSIONS TABLE

MODEL NUMBER	MARKING (1, 2)	A		D		E		e ₁			
		MAX.		MAX.		MAX.		MIN.		MAX.	
		IN	MM	IN	MM	IN	MM	IN	MM	IN	MM
V130LA1	1301	.46	11.7	.34	8.7	.20	5.0	.07	1.9	.12	3.1
V130LA2	1302	.46	11.7	.34	8.7	.20	5.0	.07	1.9	.12	3.1
V150LA1	1501	.46	11.7	.34	8.7	.21	5.3	.08	2.1	.13	3.3
V150LA2	1502	.46	11.7	.34	8.7	.21	5.3	.08	2.1	.13	3.3
V250LA2	2502	.46	11.7	.34	8.7	.27	6.9	.12	3.2	.19	4.9
V250LA4	2504	.46	11.7	.34	8.7	.27	6.9	.12	3.2	.19	4.9
V275LA2	2752	.46	11.7	.34	8.7	.29	7.4	.14	3.5	.22	5.5
V275LA4	2754	.46	11.7	.34	8.7	.29	7.4	.14	3.5	.22	5.5
V300LA2	3002	.46	11.7	.34	8.7	.30	7.7	.15	3.8	.23	5.7
V300LA4	3004	.46	11.7	.34	8.7	.30	7.7	.15	3.8	.23	5.7

DIMENSIONS TABLE

MODEL NUMBER	MARKING (1, 2)	A		D		E		e ₁			
		MAX.		MAX.		MAX.		MIN.		MAX.	
		IN	MM	IN	MM	IN	MM	IN	MM	IN	MM
V95LA7	V95LA7_	.74	18.9	.65	16.4	.17	4.4	.07	1.7	.11	2.7
V130LA10	V130LA10_	.74	18.9	.65	16.4	.21	5.3	.08	2.1	.14	3.5
V150LA10	V150LA10_	.74	18.9	.65	16.4	.21	5.3	.08	2.1	.14	3.5
V250LA15	V250LA15_	.74	18.9	.65	16.4	.26	6.7	.13	3.4	.20	5.0
V250LA20	V250LA20_	.74	18.9	.65	16.4	.26	6.7	.13	3.4	.20	5.0
V275LA15	V275LA15_	.74	18.9	.65	16.4	.29	7.3	.14	3.7	.22	5.5
V275LA20	V275LA20_	.74	18.9	.65	16.4	.29	7.3	.14	3.7	.22	5.5
V320LA15	V320LA15_	.74	18.9	.65	16.4	.32	8.2	.16	4.2	.25	6.4
V320LA20	V320LA20_	.74	18.9	.65	16.4	.32	8.2	.16	4.2	.25	6.4
V420LB20	V420LB20_	.74	18.9	.65	16.4	.41	10.3	.21	5.4	.33	8.5
V460LB20	V460LB20_	.74	18.9	.65	16.4	.41	10.3	.21	5.4	.33	8.5
V480LB20	V480LB20_	.74	18.9	.65	16.4	.48	10.7	.23	5.9	.35	8.8
V480LB40	V480LB40_	.74	18.9	.65	16.4	.48	10.7	.23	5.9	.35	8.8
V510LB20	V510LB20_	.74	18.9	.65	16.4	.44	11.1	.25	6.4	.36	9.2
V510LB40	V510LB40_	.74	18.9	.65	16.4	.44	11.1	.25	6.4	.36	9.2
V550LB20	V550LB20_	.74	18.9	.65	16.4	.46	11.6	.26	6.7	.38	9.6
V550LB40	V550LB40_	.74	18.9	.65	16.4	.46	11.6	.26	6.7	.38	9.6
V575LB20	V575LB20_	.74	18.9	.65	16.4	.49	12.4	.27	6.9	.41	10.5
V575LB40	V575LB40_	.74	18.9	.65	16.4	.49	12.4	.27	6.9	.41	10.5
V1000LB80	V1000LB80_	.74	18.9	.65	16.4	.72	18.4	.46	11.7	.65	16.5

- (-) A or B selection.
- All devices to be marked with part designation as indicated, plus 2-digit date code and either the General Electric monogram or the initials GE.
- Drawings are not to scale.
- Lead dimensions as measured within 0.05" (1.3mm) of seating plane.

OUTLINE DRAWING SIZE 2

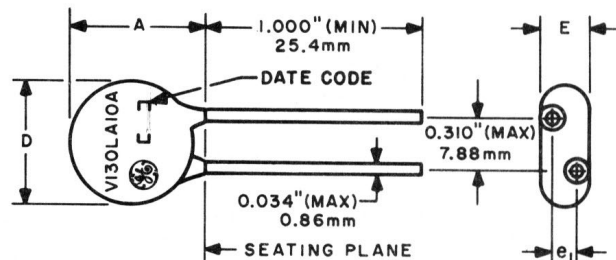

"LA" CONFIGURATION

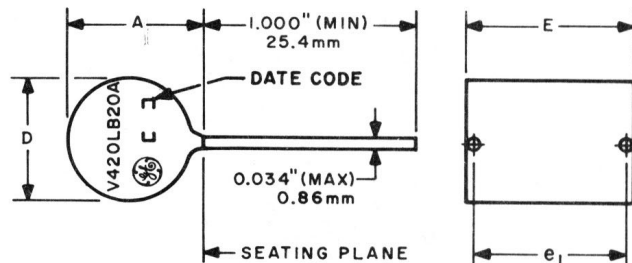

"LB" CONFIGURATION

DIMENSIONS TABLE

MODEL NUMBER	MARKING (1, 2)	A		D		E		e ₁			
		MAX.		MAX.		MAX.		MIN.		MAX.	
		IN	MM	IN	MM	IN	MM	IN	MM	IN	MM
V130LA20	V130LA20_	1.00	25.5	0.89	22.5	.21	5.3	.08	2.1	.14	3.5
V150LA20	V150LA20_	1.00	25.5	0.89	22.5	.21	5.3	.08	2.1	.14	3.5
V250LA40	V250LA40_	1.00	25.5	0.89	22.5	.29	7.3	.14	3.5	.22	5.6
V275LA40	V275LA40_	1.00	25.5	0.89	22.5	.29	7.3	.14	3.5	.22	5.6
V320LA40	V320LA40_	1.00	25.5	0.89	22.5	.32	8.2	.17	4.4	.26	6.5
V420LB40	V420LB40_	1.10	27.9	0.95	24.1	.41	10.4	.22	5.5	.34	8.7
V460LB40	V460LB40_	1.10	27.9	0.95	24.1	.41	10.4	.22	5.5	.34	8.7
V480LB80	V480LB80_	1.10	27.9	0.95	24.1	.44	11.1	.24	6.0	.37	9.4
V510LB80	V510LB80_	1.10	27.9	0.95	24.1	.44	11.1	.24	6.0	.37	9.4
V550LB80	V550LB80_	1.10	27.9	0.95	24.1	.49	12.4	.27	6.8	.42	10.7
V575LB80	V575LB80_	1.10	27.9	0.95	24.1	.49	12.4	.27	6.8	.42	10.7
V1000LB160	V1000LB160_	1.10	27.9	0.95	24.1	.73	18.6	.47	12.0	.67	16.9

- (-) A or B selection.
- All devices to be marked with part designation as indicated, plus 2-digit date code and either the General Electric Monogram or the initials GE.
- Drawings are not to scale.
- Lead dimensions as measured within 0.05" (1.3mm) of seating plane.

OUTLINE DRAWING SIZE 3

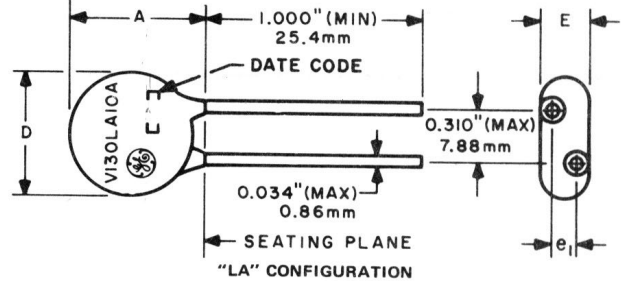

"LA" CONFIGURATION

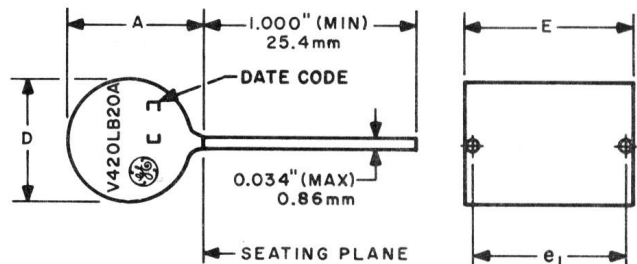

"LB" CONFIGURATION

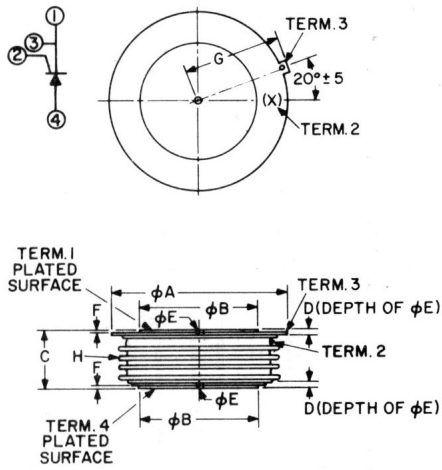

SYMBOL	INCHES
ϕA	4.350 MAX.
ϕB	2.830 MAX.
C	1.447 MAX.
D	0.080 MIN.
ϕE	0.146 MAX.
F	0.340 MIN.
G	2.418 MAX.
H	NOTE I

NOTE: GLAZED CERAMIC INSULATOR WITH 1.640 (41.66mm) MIN. SURFACE CREEPAGE.

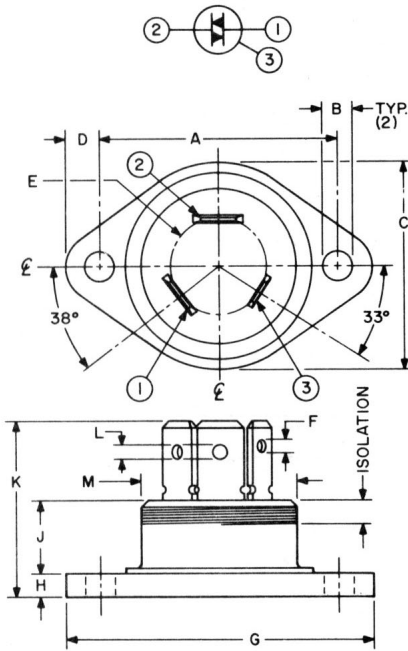

TERMINAL SPECIFICATIONS			
TERMINAL	ACCEPTS FAST-ON CONNECTOR	WIDTH	THK.
1 & 2	.250 SER.	N	P
3	.187 SER.	Q	R

NOTES:
I. TERMINAL CENTERS ARE LOCATED ON "E" DIA.

SYM.	INCHES		METRIC (MM)		NOTE
	MIN.	MAX.	MIN.	MAX.	
A	1.182	1.192	30.02	39.80	
B	.150	.161	3.81	4.09	
C	.975	1.025	24.76	26.04	
D	.175 REF.		4.46 REF.		
E	.480	.500	12.19	12.70	1
F	.050 REF.		1.27 REF.		
G	1.507	1.567	38.27	39.80	
H	.119	.131	3.02	3.33	
J	—	.400	—	10.16	
K	.900	.960	22.86	24.36	
L	.070 REF.		1.77 REF.		
M	.778	.810	19.76	20.57	
N	.247	.253	6.27	6.43	
P	.031	.033	.78	.84	22-D
Q	.184	.190	4.67	4.83	
R	.019	.021	.48	.53	