

INTERNATIONAL RECTIFIER

2N1792, 2N1805, 2N1909, 2N2023 SERIES

110 Amp RMS SCRs

Major Ratings and Characteristics

	2N1792 thru 2N1804	2N1805 thru 2N1907	2N1909 thru 2N1916	2N2023 thru 2N2030	Units
I_T (RMS)	110	110	110	110	A
I_T (AV) @ T_C	70*	70*	70*	70*	A
T_C	65*	62*	85*	85*	°C
I_{TSM} @ 50 Hz	955	955	955	955	A
@ 60 Hz	1,000*	1,000*	1,000*	1,000*	A
I_{2t} @ 50 Hz	4,550	4,550	4,550	4,550	A ^{2s}
@ 60 Hz	4,150	4,150	4,150	4,150	A ^{2s}
I_{GT}	70	70	70	70	mA
dv/dt	200	200	50	50	V/ μ s
di/dt	100	100	100	100	A/ μ s
T_J	65* to 125*	40* to 125*	65* to 150*	65* to 150*	°C
V_{RRM} , V_{DRM} range	50* to 1,200*	25* to 840*	25* to 400*	25* to 400*	V

*JEDEC registered values

Description/Features

- For general purpose phase control applications
- Forward and reverse voltage ratings up to 1200V
- High temperature series
- High surge rating
- Standard 1/2" – 20 stud
- Can be supplied as JAN and JAN-TX devices in accordance with MIL-S-19500/203 or MIL-S-19500/204.

*JEDEC registered values.

CASE STYLE AND DIMENSIONS

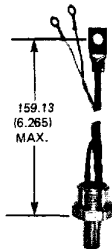

Case style (ceramic) A-11 furnished when part is rated 1000V or higher. A-13 (glass) for parts below 1000V.

JAN and/or JAN/TX types available.

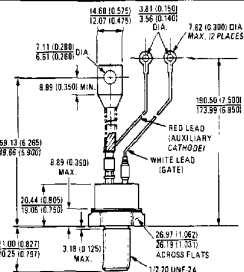

Refer to Page A-34 for flag terminal Case Style

All Dimensions in Millimeters and (inches)

IR Case Style A-13
Conforms to JEDEC Outline TO-209AC (TO-94)

VOLTAGE RATINGS (Applied gate voltage zero or negative)

Part Numbers			V_{RRM} - Max. Repetitive Peak Reverse Voltage (V)	V_{DRM} - Max. Repetitive Peak Off-State Voltage (V) ^①	V_{RSM} - Max. Non-Repetitive Peak Reverse Voltage $t_p < 5$ ms (V)
TO-208AD Case	TO-209AC Case	TO-209AC Case	$T_J = -40^\circ\text{C to } 125^\circ\text{C}$	$T_J = -40^\circ\text{C to } 125^\circ\text{C}$	$T_J = 25^\circ\text{C to } 125^\circ\text{C}$
-	2N1809	2N2023	25*	25*	35*
2N1792	2N1810	2N2024	50*	50*	70*
2N1793	2N1811	2N2025	100*	100*	150*
2N1794	2N1812	2N2026	150*	150*	225*
2N1795	2N1813	2N2027	200*	200*	300*
2N1796	2N1814	2N2028	250*	250*	350*
2N1797	2N1815	2N2029	300*	300*	400*
2N1798	2N1816	2N2030	400*	400*	500*
2N1799	2N1805	-	800*	800*	625*
2N1800	2N1806	-	720*	600*	750*
2N1801	2N1807	-	840*	700*	880*
2N1802	-	-	960*	800*	1000*
2N1803	-	-	1080*	900*	1130*
2N1804	-	-	1200*	1000*	1250*

ELECTRICAL SPECIFICATIONS

	2N1792 to 2N1804	2N1909-16 2N1805-07	2N2023-30	Units	Conditions
ON STATE					
$I_{T(RMS)}$	Max. RMS on-state current	110	110	110	A
$I_{T(AV)}$	Max. average on-state current @ Max. T_C *	70*	70*	70*	A
		65*	62*	85*	°C
I_{TSM}	Max. peak one cycle, non-repetitive surge current	955	955	955	A
		1000*	1000*	1000*	A
		1150	1150	1150	A
		1200	1200	1200	A
I^2t	Max. I^2t capability, for fusing	4550	4550	4550	A ² s
		4150	4150	4150	A ² s
I^2t	Max. I^2t capability, for individual device fusing	6450	6450	6450	A ² s
		5900	5900	5900	A ² s
I^2t	Max. I^2t capability, for individual device fusing ^②	64 500	64 500	64 500	A ² /s
V_{TM}	Max. peak on-state voltage	1.85*	1.85*	1.9*	V
		2.0*	-	-	V
I_H	Typical holding current.	20	20	20	mA

* JEDEC registered values.

① Units may be broken over non-repetitively without damage if di/dt does not exceed 20 A/ μ s.② I^2t for time $t_x = I^2/t$ $\sqrt{t_x}$.

ELECTRICAL SPECIFICATIONS (Continued)

	2N1792 to 2N1804	2N1909-16 2N1805-07	2N2023-30	Units	Conditions
BLOCKING					
dv/dt	Min. critical rate-of-rise of off-state voltage	200	200	50	$V/\mu s$ $T_J = 125^\circ C$ Exponential to 100% rated V_{DRM} . Gate open circuit. $T_J = 150^\circ C$ for 2N2023-30.
$I_{R(AV)}$ & $I_{D(AV)}$	Max. average reverse and off-state current V_{RRM} & V_{DRM} = 25V to 150V	6.5*	6.5*	6.5*	At rated V_{RRM} , V_{DRM} , $T_J = \text{max. rated}$, gate open circuited.
	= 200V	6.0*	6.5*	6.0*	
	= 250V	5.5*	5.5*	5.5*	
	= 300V	5.0*	5.0*	5.0*	
	= 400V	4.0*	4.0*	4.0*	
	= 500V to 600V	3.3* ^①	3.3* ^①	—	
	= 700V to 800V	3.0* ^①	3.0* ^①	—	
	= 900V to 1200V	2.7* ^①	—	—	
SWITCHING					
t_d	Typical delay time	1	1	1	μs $T_C = 25^\circ C$, $V_{DM} = \text{rated } V_{DRM}$, $I_{TM} = 50A$ dc resistive circuit. Gate pulse: 10V, 25 Ω source, $t_p = 6\mu s$, $t_r = 0.1\mu s$
t_r	Typical rise time	1.5	1.5	1.5	
t_d	Typical turn-off time	40	40	40 (70 @ 150°C)	μs $T_C = 125^\circ C$, $I_{TM} = 50A$, commutating $di/dt = -5 A/\mu s$, min. V_R during turn-off interval = 50V, $dv/dt = 20 V/\mu s$ linear to rated V_{DRM}
di/dt	Max. non-repetitive rate-of-rise of turned-on current V_{DRM} = 25V to 600V = 700V to 1200V	100 75	100 75	100 75	$A/\mu s$ $T_C = 125^\circ C$, $V_{DM} = \text{rated } V_{DRM}$ $I_{TM} = (2 \times \text{rated } di/dt) A$ Gate pulse: 20V, 15 Ω , $t_p \geq 8\mu s$, $t_r = 0.1\mu s$ Per JEDEC Standard RS-297, 5.2.2.6.
TRIGGERING					
P_{GM}	Max. peak gate power	5*	5*	5*	W $t_p = 5ms$ max.
$P_{G(AV)}$	Max. average gate power	0.5*	0.5*	0.5*	W
$+I_{GM}$	Max. peak positive gate current	2*	2*	2*	A
$+V_{GM}$	Max. peak positive gate voltage	10*	10*	10*	V
$-V_{GM}$	Max. peak negative gate voltage	5*	5*	5*	V
I_{GT}	Max. required DC gate current to trigger	130* ① 70 40 —	130* 70 40 —	150* @ -85°C 70 — 35	mA $T_C = -40^\circ C$. Max. required gate trigger current is the lowest value which will trigger all units with +6V anode-to-cathode. $T_C = 25^\circ C$ $T_C = 125^\circ C$ $T_C = 150^\circ C$
	Typical DC gate current to trigger	35	35	35	$T_C = 25^\circ C$ +6V anode-to-cathode

*JEDEC registered values.

① V_{RRM} 20% greater than V_{DRM} .

② For 2N1803, 1804: $I_{GT} = 200 mA$ @ $-40^\circ C$; 110mA @ $25^\circ C$; 60 mA @ $125^\circ C$.

ELECTRICAL SPECIFICATIONS (Continued)

	2N1792 to 2N1804	2N1809-16 to 2N1805-07	2N2023-30	Units	Conditions
TRIGGERING [Cont.]					
V_{GT}	Max. required DC gate voltage to trigger	—	—	3*	V $T_C = -65^\circ\text{C}$. Max. required gate trigger voltage is the lowest value which will trigger all units with +6V anode-to-cathode. $T_C = -40^\circ\text{C}$ $T_C = 25^\circ\text{C}$ $T_C = 25^\circ\text{C}$ +6V anode-to-cathode
		3*	3*	—	
		2.5	2.5	2.0	
	Typical DC gate voltage to trigger	1.2	1.2	1.2	
V_{GD}	Max. DC gate voltage not to trigger	0.25*	0.25*	0.25* @ 150°C	V $T_C = 125^\circ\text{C}$. Max. gate voltage not to trigger is the maximum value which will not trigger any unit with rated V_{DRM} anode to cathode.

THERMAL-MECHANICAL SPECIFICATIONS

T_J	Operating junction temperature range	-65° to 125°	-40° to 125°	-65° to 150°	°C	
T_{stg}	Storage temperature range	-40° to 150°	-40° to 125°	-65° to 150°	°C	
R_{thJC}	Max. internal thermal resistance, junction-to-case	0.4* ①	0.4*	0.4*	deg. C/W	DC operation
R_{thCS}	Thermal resistance, case-to-sink	0.1	0.1	0.1	deg. C/W	Mounting surface smooth, flat and greased.
T	Mounting torque				N·m	Non-lubricated threads
	Min.	14.5 (1.25)			(lb·ft·in)	
	Max.	17 (150)				
	Max. torque on screw in flagterminal	1.4 (12)	—	—	N·m (lb·ft·in)	Non-lubricated threads TO-20BAD (TO-83) only
wt	Approximate weight	100 (3.5)			g (oz)	
	Case style	2N1805-07; 2N1809-16; 2N2023-30; TO-209AC (TO-94) 1A-13			JEDEC	
		2N1792-1804; TO-20BAD (TO-83) 1A-14			JEDEC	

*JEDEC registered values.

① 2N1803, 2N1804: $R_{thJC} = 0.35$ deg. C/W.

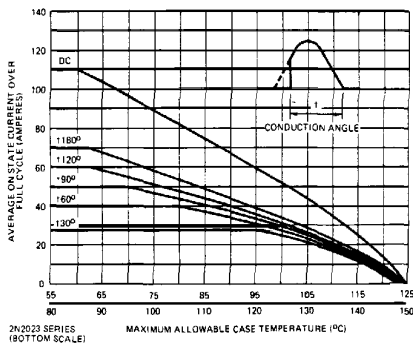

Fig. 1 — On-State Current Vs. Case Temperature (Sinusoidal Current Waveform, 50 to 400 Hz)

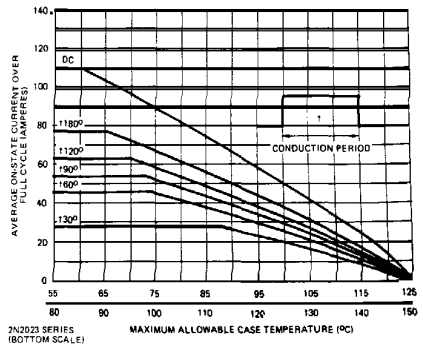

Fig. 2 — On-State Current Vs. Case Temperature (Rectangular Current Waveform, 50 to 400 Hz)

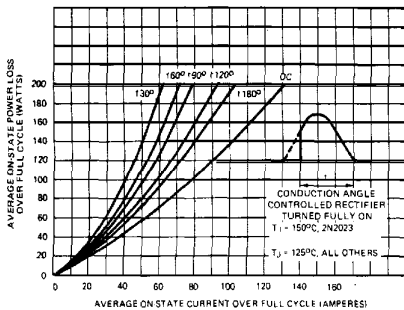

Fig. 3 – Maximum Low-Level On-State Power Loss Vs. Current (Sinusoidal Current Waveform)

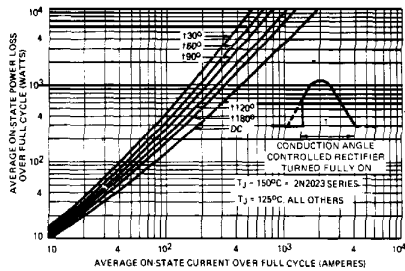

Fig. 4 – Maximum High-Level On-State Power Loss Vs. Current (Sinusoidal Current Waveform)

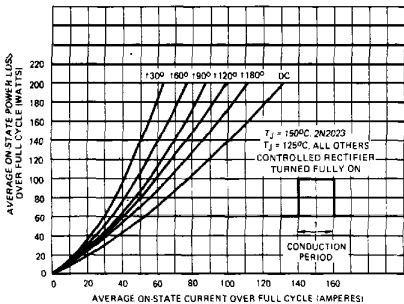

Fig. 5 – Maximum Low-Level On-State Power Loss Vs. Current (Rectangular Current Waveform)

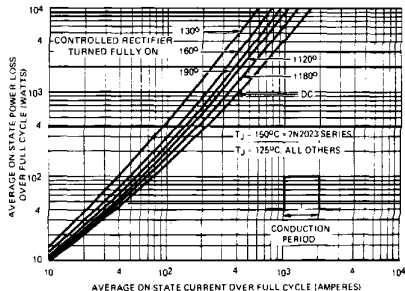

Fig. 6 – Maximum High-Level On-State Power Loss Vs. Current (Rectangular Current Waveform)

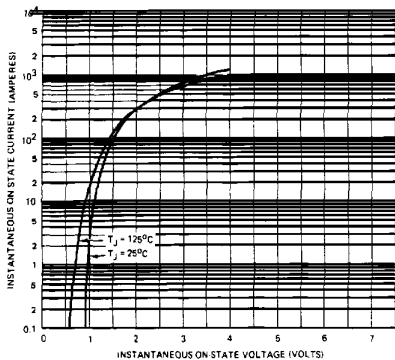

Fig. 7 – Maximum Instantaneous On-State Voltage Vs. Current (2N1792, 2N1805 and 2N1909 Series)

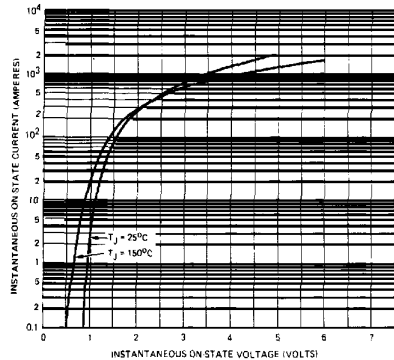

Fig. 8 – Maximum Instantaneous On-State Voltage Vs. Current (2N2023 Series)

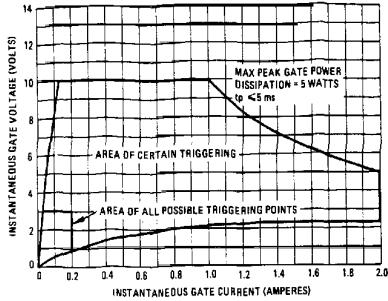

Fig. 9 - Gate Characteristics

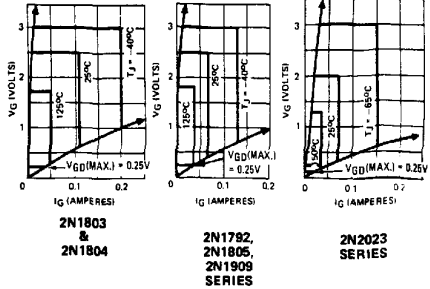

Fig. 9A - Areas of All Possible Triggering Points Vs. Junction Temperature

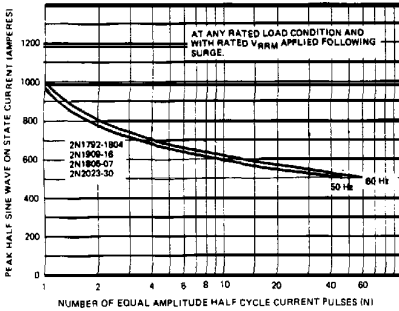

Fig. 10 - Maximum Non-Repetitive Surge Current Vs. Number of Current Pulses

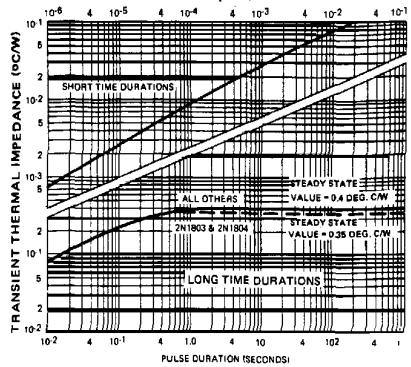
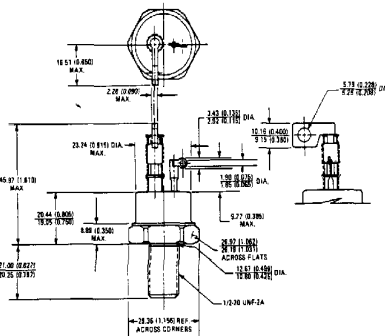

Fig. 11 - Transient Thermal Impedance, Junction to Case, Vs. Pulse Duration



IR Case Style A-14
 Conforms to JEDEC Outline TO-208AD (TO-83)
 All Dimensions in Millimeters and (Inches)