

**SURFACE MOUNT
SCHOTTKY BARRIER RECTIFIER**

**REVERSE VOLTAGE – 40 Volts
FORWARD CURRENT – 1.0 Ampere**

FEATURES

- Low Forward Voltage Drop
- High Surge Capability and High Current Capability
- For Surface Mounted Applications
- High Conductance
- Guard Ring Construction for Transient Protection
- ESD Capability:
Machine Model, C (> 400 V)
Human Body Model, 3B (> 8 kV)
- IEC 61000-4-2, level 4 (ESD), >15KV (air)

MECHANICAL DATA

- Case: SOD-123 Plastic
- Case Material: "Green" molding compound, UL flammability classification 94V-0, (No Br. Sb. Cl)
- Moisture Sensitivity: Level 1 per J-STD-020D
- Lead Pb-Free in RoHS 2002/95/EC Compliant
- Weight: approx. 0.01 grams (approximate)

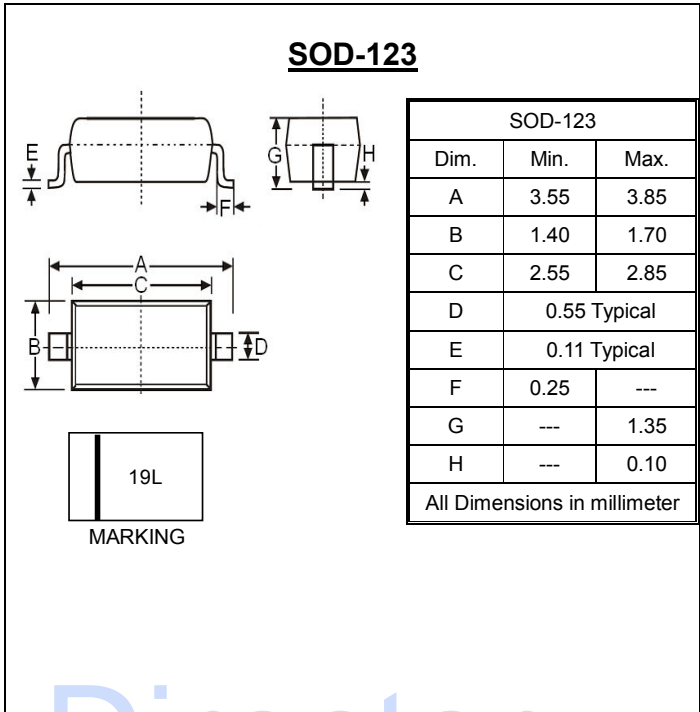

Maximum Ratings and Thermal Characteristics @ T_A = 25°C unless otherwise specified

Characteristic	Symbol	Value	Units
Repetitive Peak Reverse Voltage	V _{RRM}	40	V
Working Peak Reverse Voltage	V _{RWM}		
DC Blocking Voltage	V _R		
RMS Reverse Voltage	V _{R(RMS)}	28	V
Forward Continuous Current (Note 1) @ TC=75°C	I _F	1.0	A
Non-Repetitive Peak Forward Surge Current 8.3ms Single half sine-wave superimposed on rated load (JEDEC Method)	I _{FSM}	25	A
Power Dissipation (Note 1)	P _D	450	mW
Thermal Resistance (Note 2)	R _{θJA}	230	°C/W
Operating and Storage Temperature Range	T _J , T _{STG}	-65 to +125	°C

Electrical Characteristics @ T_A = 25°C unless otherwise specified

Parameter	Symbol	Value	Unit	Test Condition
Minimum Reverse Breakdown Voltage	V _{(BR)R}	40	V	I _R = 1.0mA
Maximum Forward Voltage	V _F	320	mV	I _F = 0.1A
		450		I _F = 1.0A
		750		I _F = 3.0A
Maximum DC Reverse Current at Rated DC Blocking Voltage	I _R	50	uA	VR = 4.0V, T _J = 25°C
		75		VR = 6.0V, T _J = 25°C
		1.0	mA	VR = 40V, T _J = 25°C
		10		VR = 40V, T _J = 100°C
		2.0		VR = 4.0V, T _J = 100°C
3.0	VR = 6.0V, T _J = 100°C			
Typical Junction Capacitance	C _J	70	pF	V _R = 4V DC, f = 1.0MHz

Note :

- (1)Unit mounted with 7.0*7.0mm copper pad areas
- (2)Thermal Resistance Junction to Ambient,

REV. 3, Mar-2012, KSHR01

FIG.1- FORWARD CURRENT DERATING CURVE

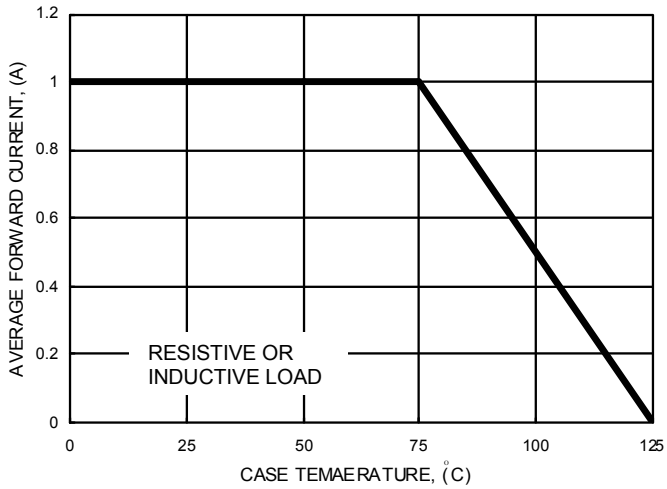

FIG.2- TYPICAL JUNCTION CAPACITANCE

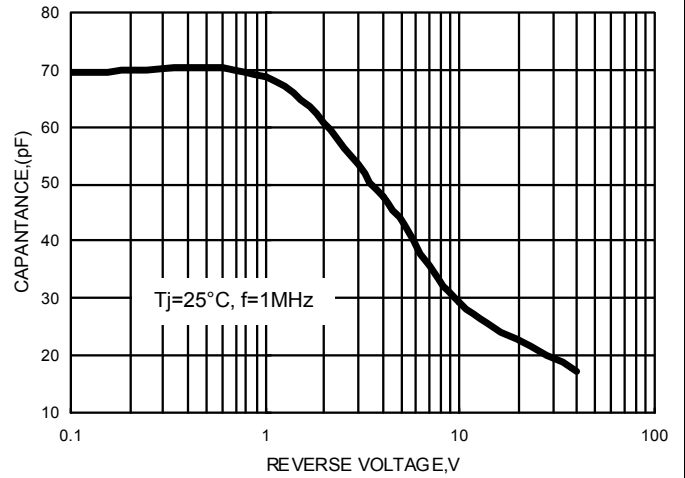

FIG.3- TYPICAL FORWARD CHARACTERISTICS

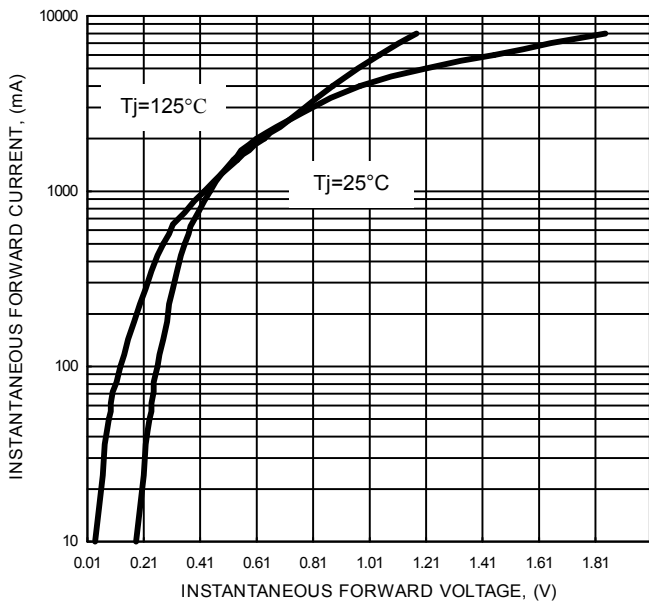

FIG.4- TYPICAL REVERSE CHARACTERISTICS

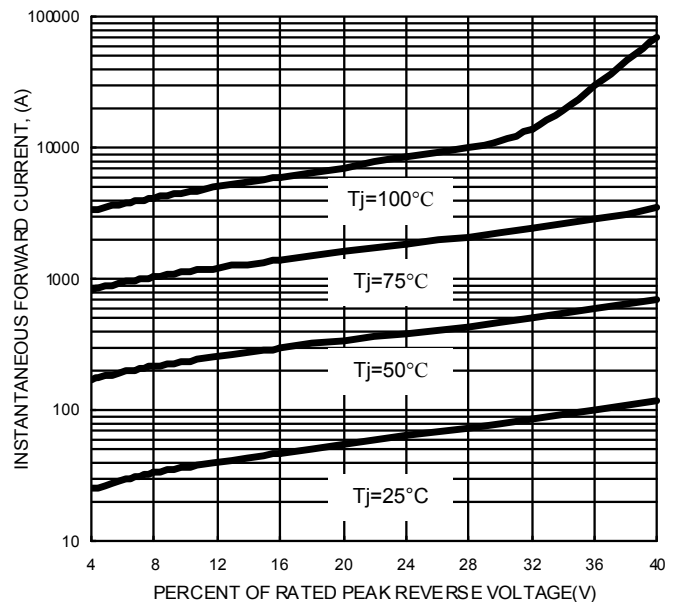

FIG.5- MAXIMUM NON-REPETITIVE SURGE CURRENT

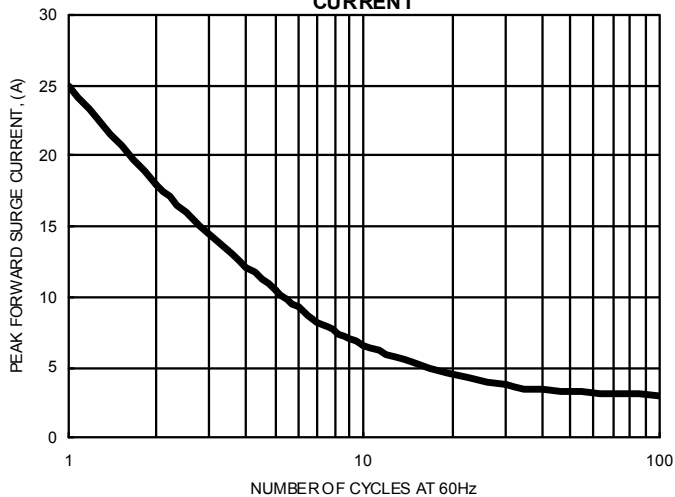
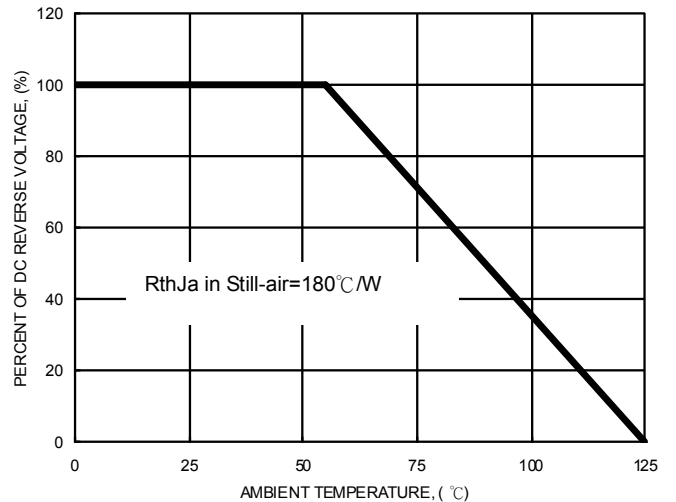

FIG.6- DC REVERSE VOLTAGE DERATING CURVE



Important Notice and Disclaimer

LSC reserves the right to make changes to this document and its products and specifications at any time without notice. Customers should obtain and confirm the latest product information and specifications before final design, purchase or use.

LSC makes no warranty, representation or guarantee regarding the suitability of its products for any particular purpose, nor does LSC assume any liability for application assistance or customer product design. LSC does not warrant or accept any liability with products which are purchased or used for any unintended or unauthorized application.

No license is granted by implication or otherwise under any intellectual property rights of LSC.

LSC products are not authorized for use as critical components in life support devices or systems without express written approval of LSC.