

Small Signal Zener Diodes

Features

- These diodes are also available in other case styles and other configurations including: the SOD-123 case with type designation BZT52 series, the dual zener diode common anode configuration in the SOT-23 case with type designation AZ23 series and the dual zener diode common cathode configuration in the SOT-23 case with type designation DZ23 series.

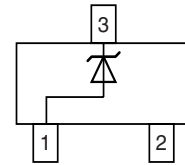
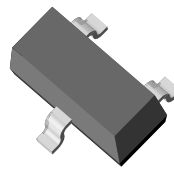

18078

- The Zener voltages are graded according to the international E 24 standard. Standard Zener voltage tolerance is $\pm 5\%$. Replace "C" with "B" for $\pm 2\%$ tolerance.
- Silicon Planar Power Zener Diodes

Mechanical Data

Case: SOT-23 Plastic Package

Weight: approx. 8.8 mg

Packaging Codes/Options:

GS18 / 10 k per 13" reel (8 mm tape), 10 k/box

GS08 / 3 k per 7" reel (8 mm tape), 15 k/box

Absolute Maximum Ratings

$T_{amb} = 25\text{ }^{\circ}\text{C}$, unless otherwise specified

Parameter	Test condition	Symbol	Value	Unit
Power dissipation		P_{tot}	300 ¹⁾	mW

¹⁾ Device on fiberglass substrate, see layout.

Thermal Characteristics

$T_{amb} = 25\text{ }^{\circ}\text{C}$, unless otherwise specified

Parameter	Test condition	Symbol	Value	Unit
Thermal resistance junction to ambient air		R_{thJA}	420 ¹⁾	$^{\circ}\text{C}/\text{W}$
Junction temperature		T_j	150	$^{\circ}\text{C}$
Storage temperature range		T_s	- 65 to + 150	$^{\circ}\text{C}$

¹⁾ Device on fiberglass substrate, see layout.



Electrical Characteristics

Partnumber	Marking Code	Zener Voltage Range		Dynamic Resistance		Test Current	Temp. Coefficient of Zener Voltage		Test Current	Reverse Leakage Current	
		$V_Z @ I_{ZT1}$		$r_{zj} @ I_{ZT1}$	$r_{zj} @ I_{ZT2}$	I_{ZT1}	$\alpha_{VZ} @ I_{ZT1}$		I_{ZT2}	I_R	@ V_R
		V		Ω		mA	$10^{-4}/^{\circ}C$		mA	μA	V
		min	max				min	max			
BZX84C2V4	Z11	2.2	2.6	70 (≤ 100)	275	5	-9.0	-4.0	1	50	1
BZX84C2V7	Z12	2.5	2.9	75 (≤ 100)	300 (≤ 600)	5	-9.0	-4.0	1	20	1
BZX84C3	Z13	2.8	3.2	80 (≤ 95)	325 (≤ 600)	5	-9.0	-3.0	1	10	1
BZX84C3V3	Z14	3.1	3.5	85 (≤ 95)	350 (≤ 600)	5	-8.0	-3.0	1	5	1
BZX84C3V6	Z15	3.4	3.8	85 (≤ 90)	375 (≤ 600)	5	-8.0	-3.0	1	5	1
BZX84C3V9	Z16	3.7	4.1	85 (≤ 90)	400 (≤ 600)	5	-7.0	-3.0	1	3	1
BZX84C4V3	Z17	4	4.6	80 (≤ 90)	410 (≤ 600)	5	-6.0	-1.0	1	3	1
BZX84C4V7	Z1	4.4	5	50 (≤ 80)	425 (≤ 500)	5	-5.0	+2.0	1	3	2
BZX84C5V1	Z2	4.8	5.4	40 (≤ 60)	400 (≤ 480)	5	-3.0	+4.0	1	2	2
BZX84C5V6	Z3	5.2	6	15 (≤ 40)	80 (≤ 400)	5	-2.0	+6.0	1	1	2
BZX84C6V2	Z4	5.8	6.6	6.0 (≤ 10)	40 (≤ 150)	5	-1.0	+7.0	1	3	4
BZX84C6V8	Z5	6.4	7.2	6.0 (≤ 15)	30 (≤ 80)	5	+2.0	+7.0	1	2	4
BZX84C7V5	Z6	7	7.9	6.0 (≤ 15)	30 (≤ 80)	5	+3.0	+7.0	1	1	5
BZX84C8V2	Z7	7.7	8.7	6.0 (≤ 15)	40 (≤ 80)	5	+4.0	+7.0	1	0.7	5
BZX84C9V1	Z8	8.5	9.6	6.0 (≤ 15)	40 (≤ 100)	5	+5.0	+8.0	1	0.5	6
BZX84C10	Z9	9.4	10.6	8.0 (≤ 20)	50 (≤ 150)	5	+5.0	+8.0	1	0.2	7
BZX84C11	Y1	10.4	11.6	10 (≤ 20)	50 (≤ 150)	5	+5.0	+9.0	1	0.1	8
BZX84C12	Y2	11.4	12.7	10 (≤ 25)	50 (≤ 150)	5	+6.0	+9.0	1	0.1	8
BZX84C13	Y3	12.4	14.1	10 (≤ 30)	50 (≤ 170)	5	+7.0	+9.0	1	0.1	8
BZX84C15	Y4	13.8	15.6	10 (≤ 30)	50 (≤ 200)	5	+7.0	+9.0	1	0.05	0.7 V_{Znom} .
BZX84C16	Y5	15.3	17.1	10 (≤ 40)	50 (≤ 200)	5	+8.0	+9.5	1	0.05	0.7 V_{Znom} .
BZX84C18	Y6	16.8	19.1	10 (≤ 45)	50 (≤ 225)	5	+8.0	+9.5	1	0.05	0.7 V_{Znom} .
BZX84C20	Y7	18.8	21.2	15 (≤ 55)	60 (≤ 225)	5	+8.0	+10	1	0.05	0.7 V_{Znom} .
BZX84C22	Y8	20.8	23.3	20 (≤ 55)	60 (≤ 250)	5	+8.0	+10	1	0.05	0.7 V_{Znom} .
BZX84C24	Y9	22.8	25.6	25 (≤ 70)	60 (≤ 250)	5	+8.0	+10	1	0.05	0.7 V_{Znom} .
BZX84C27	Y10	25.1	28.9	25 (≤ 80)	65 (≤ 300)	2	+8.0	+10	0.5	0.05	0.7 V_{Znom} .
BZX84C30	Y11	28	32	30 (≤ 80)	70 (≤ 300)	2	+8.0	+10	0.5	0.05	0.7 V_{Znom} .
BZX84C33	Y12	31	35	35 (≤ 80)	75 (≤ 325)	2	+8.0	+10	0.5	0.05	0.7 V_{Znom} .
BZX84C36	Y13	34	38	35 (≤ 90)	80 (≤ 350)	2	+8.0	+10	0.5	0.05	0.7 V_{Znom} .
BZX84C39	Y14	37	41	40 (≤ 130)	80 (≤ 350)	2	+10	+12	0.5	0.05	0.7 V_{Znom} .
BZX84C43	Y15	40	46	45 (≤ 150)	85 (≤ 375)	2	+10	+12	0.5	0.05	0.7 V_{Znom} .
BZX84C47	Y16	44	50	50 (≤ 170)	85 (≤ 375)	2	+10	+12	0.5	0.05	0.7 V_{Znom} .
BZX84C51	Y17	48	54	60 (≤ 180)	85 (≤ 400)	2	+10	+12	0.5	0.05	0.7 V_{Znom} .
BZX84C56	Y18	52	60	70 (≤ 200)	100 (≤ 425)	2	+9.0	+11	0.5	0.05	0.7 V_{Znom} .
BZX84C62	Y19	58	66	80 (≤ 215)	100 (≤ 450)	2	+9.0	+12	0.5	0.05	0.7 V_{Znom} .
BZX84C68	Y20	64	72	90 (≤ 240)	150 (≤ 475)	2	+10	+12	0.5	0.05	0.7 V_{Znom} .
BZX84C75	Y21	70	79	95 (≤ 255)	170 (≤ 500)	2	+10	+12	0.5	0.05	0.7 V_{Znom} .



Electrical Characteristics

Partnumber	Marking Code	Zener Voltage Range		Dynamic Resistance		Test Current	Temp. Coefficient of Zener Voltage		Test Current	Reverse Leakage Current	
		$V_Z @ I_{ZT1}$		$r_{zj} @ I_{ZT1}$	$r_{zj} @ I_{ZT2}$		$\alpha_{VZ} @ I_{ZT1}$	I_{ZT2}		I_R	@ V_R
		V		Ω		mA	$10^{-4}/^{\circ}C$		mA	μA	V
		min	max				min	max			
BZX84B2V4	Z50	2.35	2.45	70 (≤ 100)	275	5	-9	-4	1	50	1
BZX84B2V7	Z51	2.65	2.75	75 (≤ 100)	300 (≤ 600)	5	-9	-4	1	20	1
BZX84B3	Z52	2.94	3.06	80 (≤ 95)	325 (≤ 600)	5	-9	-3	1	10	1
BZX84B3V3	Z53	3.23	3.37	85 (≤ 95)	350 (≤ 600)	5	-8	-3	1	5	1
BZX84B3V6	Z54	3.53	3.67	85 (≤ 90)	375 (≤ 600)	5	-8	-3	1	5	1
BZX84B3V9	Z55	3.82	3.98	85 (≤ 90)	400 (≤ 600)	5	-7	-3	1	3	1
BZX84B4V3	Z56	4.21	4.39	80 (≤ 90)	410 (≤ 600)	5	-6	-1	1	3	1
BZX84B4V7	Z57	4.61	4.79	50 (≤ 80)	425 (≤ 500)	5	-5	2	1	3	2
BZX84B5V1	Z58	5	5.2	40 (≤ 60)	400 (≤ 480)	5	-3	4	1	2	2
BZX84B5V6	Z59	5.49	5.71	15 (≤ 40)	80 (≤ 400)	5	-2	6	1	1	2
BZX84B6V2	Z60	6.08	6.32	6.0 (≤ 10)	40 (≤ 150)	5	-1	7	1	3	4
BZX84B6V8	Z61	6.66	6.94	6.0 (≤ 15)	30 (≤ 80)	5	2	7	1	2	4
BZX84B7V5	Z62	7.35	7.65	6.0 (≤ 15)	30 (≤ 80)	5	3	7	1	1	5
BZX84B8V2	Z63	8.04	8.36	6.0 (≤ 15)	40 (≤ 80)	5	4	7	1	0.7	5
BZX84B9V1	Z64	8.92	9.28	6.0 (≤ 15)	40 (≤ 100)	5	5	8	1	0.5	6
BZX84B10	Z65	9.8	10.2	8.0 (≤ 20)	50 (≤ 150)	5	5	8	1	0.2	7
BZX84B11	Z66	10.8	11.2	10 (≤ 20)	50 (≤ 150)	5	5	9	1	0.1	8
BZX84B12	Z67	11.8	12.2	10 (≤ 25)	50 (≤ 150)	5	6	9	1	0.1	8
BZX84B13	Z68	12.7	13.3	10 (≤ 30)	50 (≤ 170)	5	7	9	1	0.1	8
BZX84B15	Z69	14.7	15.3	10 (≤ 30)	50 (≤ 200)	5	7	9	1	0.05	0.7 $V_{Znom.}$
BZX84B16	Z70	15.7	16.3	10 (≤ 40)	50 (≤ 200)	5	8	9.5	1	0.05	0.7 $V_{Znom.}$
BZX84B18	Z71	17.6	18.4	10 (≤ 45)	50 (≤ 225)	5	8	9.5	1	0.05	0.7 $V_{Znom.}$
BZX84B20	Z72	19.6	20.4	15 (≤ 55)	60 (≤ 225)	5	8	10	1	0.05	0.7 $V_{Znom.}$
BZX84B22	Z73	21.6	22.4	20 (≤ 55)	60 (≤ 250)	5	8	10	1	0.05	0.7 $V_{Znom.}$
BZX84B24	Z74	23.5	24.5	25 (≤ 70)	60 (≤ 250)	5	8	10	1	0.05	0.7 $V_{Znom.}$
BZX84B27	Z75	26.5	27.5	25 (≤ 80)	65 (≤ 300)	2	8	10	0.5	0.05	0.7 $V_{Znom.}$
BZX84B30	Z76	29.4	30.6	30 (≤ 80)	70 (≤ 300)	2	8	10	0.5	0.05	0.7 $V_{Znom.}$
BZX84B33	Z77	32.3	33.7	35 (≤ 80)	75 (≤ 325)	2	8	10	0.5	0.05	0.7 $V_{Znom.}$
BZX84B36	Z78	35.3	36.7	35 (≤ 90)	80 (≤ 350)	2	8	10	0.5	0.05	0.7 $V_{Znom.}$
BZX84B39	Z79	38.2	39.8	40 (≤ 130)	80 (≤ 350)	2	10	12	0.5	0.05	0.7 $V_{Znom.}$
BZX84B43	Z80	42.1	43.9	45 (≤ 150)	85 (≤ 375)	2	10	12	0.5	0.05	0.7 $V_{Znom.}$
BZX84B47	Z81	46.1	47.9	50 (≤ 170)	85 (≤ 375)	2	10	12	0.5	0.05	0.7 $V_{Znom.}$
BZX84B51	Z82	50	52	60 (≤ 180)	85 (≤ 400)	2	10	12	0.5	0.05	0.7 $V_{Znom.}$
BZX84B56	Z83	54.9	57.1	70 (≤ 200)	100 (≤ 425)	2	9	11	0.5	0.05	0.7 $V_{Znom.}$
BZX84B62	Z84	60.8	63.2	80 (≤ 215)	100 (≤ 450)	2	9	12	0.5	0.05	0.7 $V_{Znom.}$
BZX84B68	Z85	66.6	69.4	90 (≤ 240)	150 (≤ 475)	2	10	12	0.5	0.05	0.7 $V_{Znom.}$
BZX84B75	Z86	73.5	76.5	95 (≤ 255)	170 (≤ 500)	2	10	12	0.5	0.05	0.7 $V_{Znom.}$

Typical Characteristics ($T_{amb} = 25^\circ\text{C}$ unless otherwise specified)

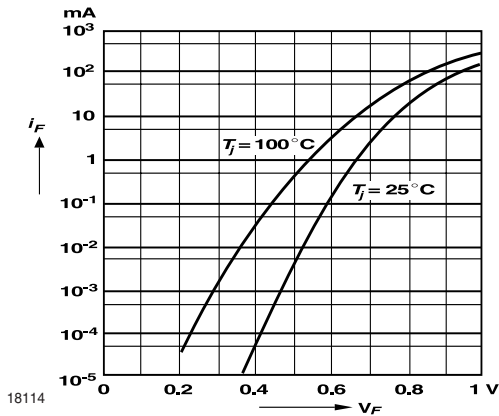

Fig. 1 Forward characteristics

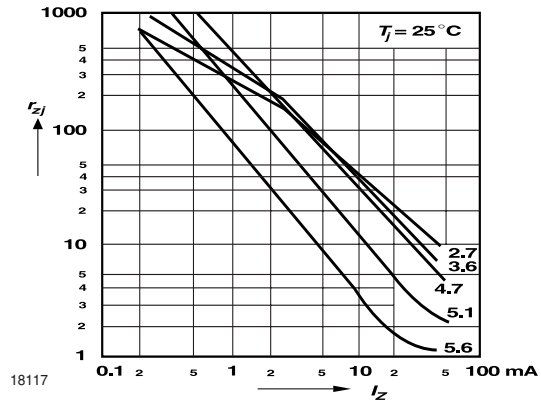

Fig. 4 Dynamic Resistance vs. Zener Current

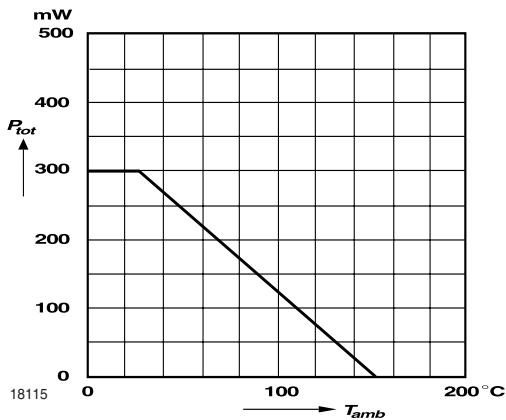

Fig. 2 Admissible Power Dissipation vs. Ambient Temperature

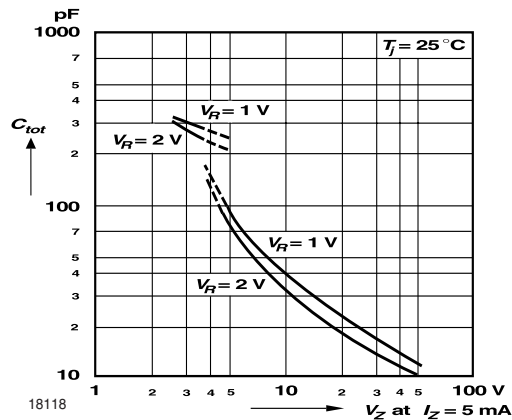

Fig. 5 Capacitance vs. Zener Voltage

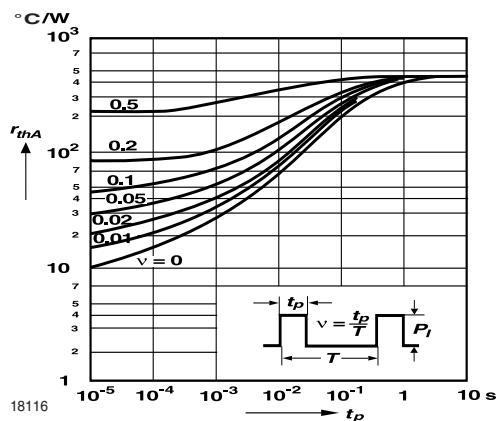

Fig. 3 Pulse Thermal Resistance vs. Pulse Duration

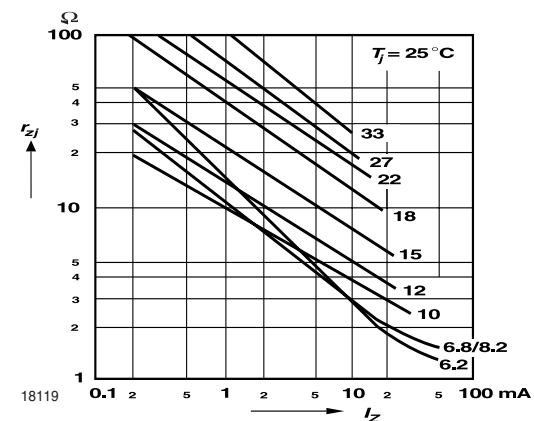

Fig. 6 Dynamic Resistance vs. Zener Current

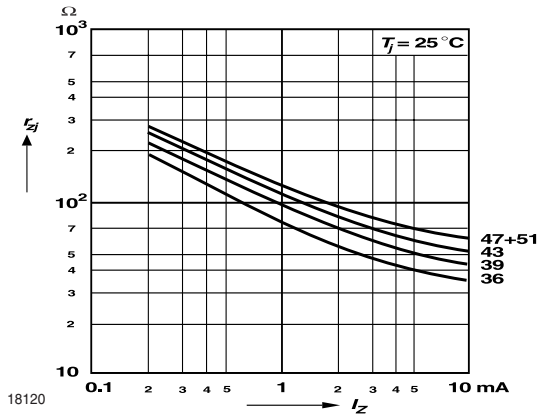

Fig. 7 Dynamic Resistance vs. Zener Current

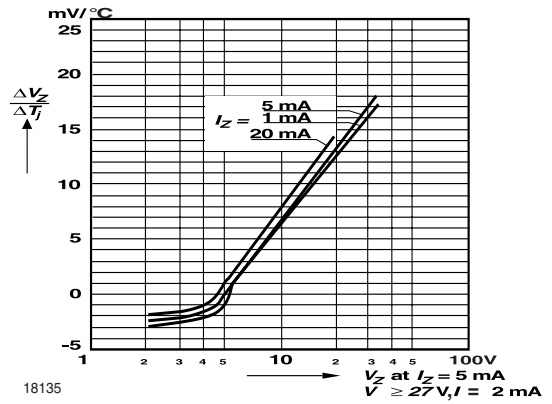

Fig. 10 Temperature Dependence of Zener Voltage vs. Zener Voltage

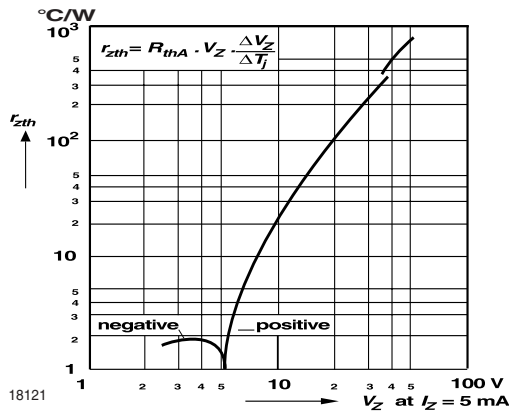

Fig. 8 Thermal Differential Resistance vs. Zener Voltage

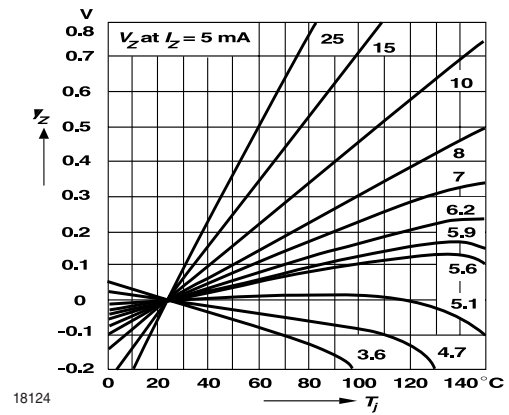

Fig. 11 Change of Zener Voltage vs. Junction Temperature

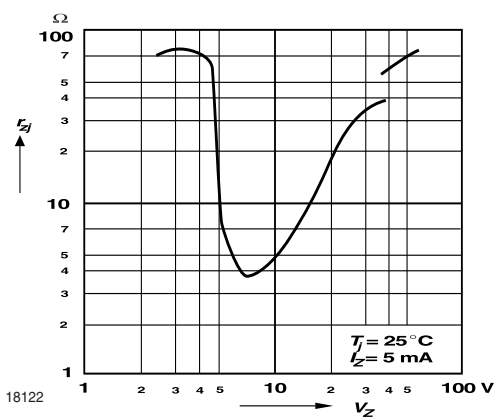

Fig. 9 Dynamic Resistance vs. Zener Voltage

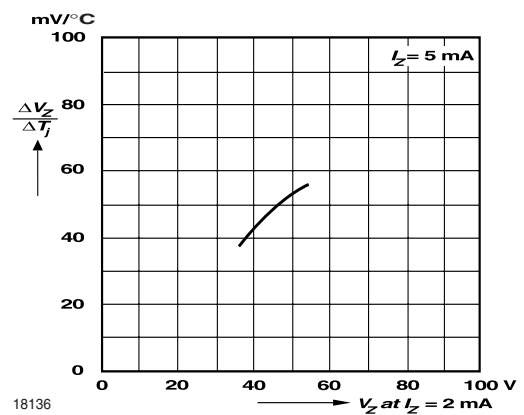

Fig. 12 Temperature Dependence of Zener Voltage vs. Zener Voltage

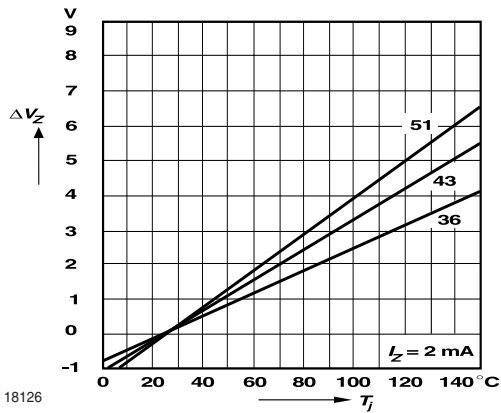

Fig. 13 Change of Zener Voltage vs. Junction Temperature

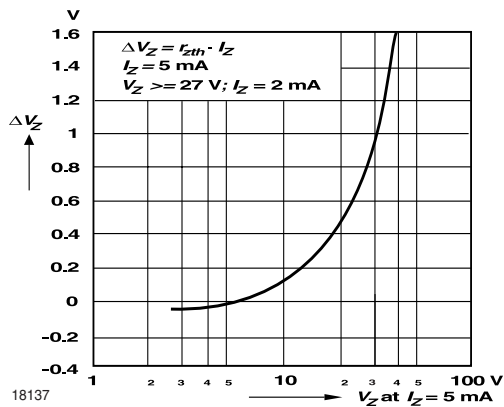

Fig. 14 Change of Zener voltage from turn-on up to the point of thermal equilibrium vs. Zener voltage

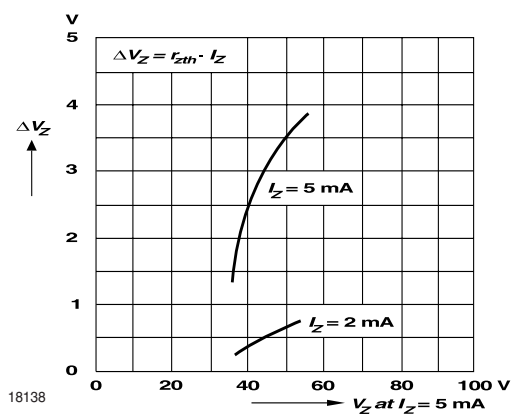

Fig. 15 Change of Zener voltage from turn-on up to the point of thermal equilibrium vs. Zener voltage

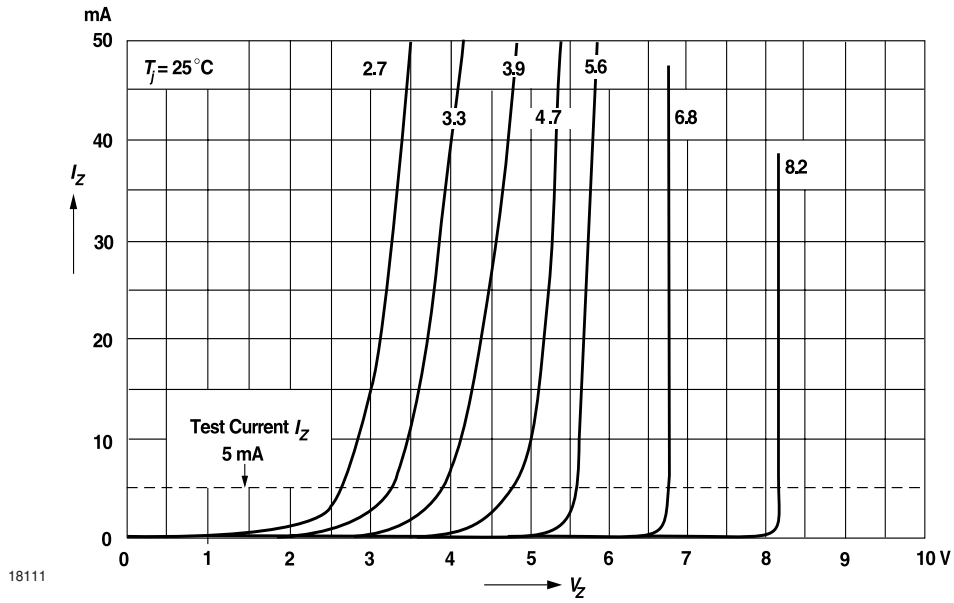

Fig. 16 Breakdown Characteristics

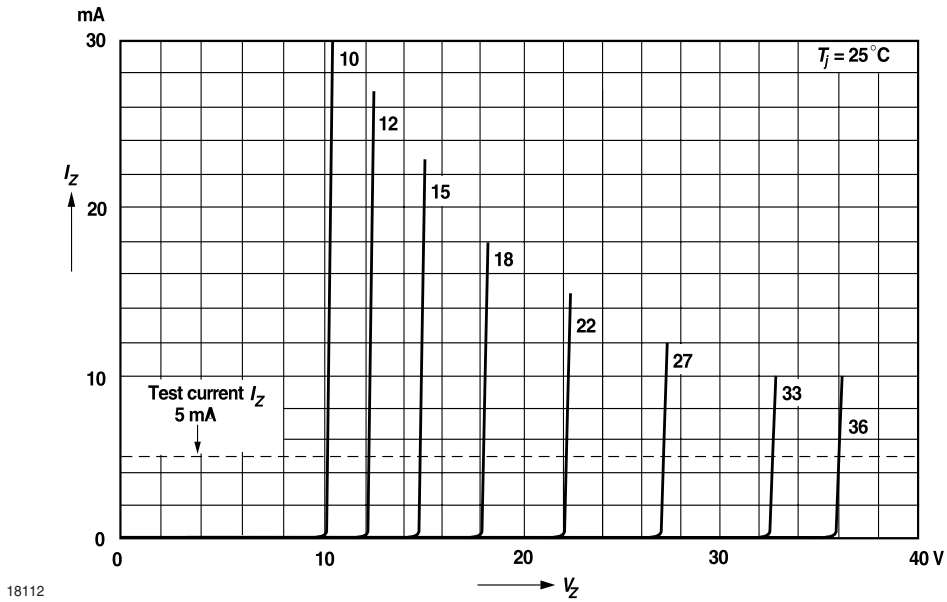
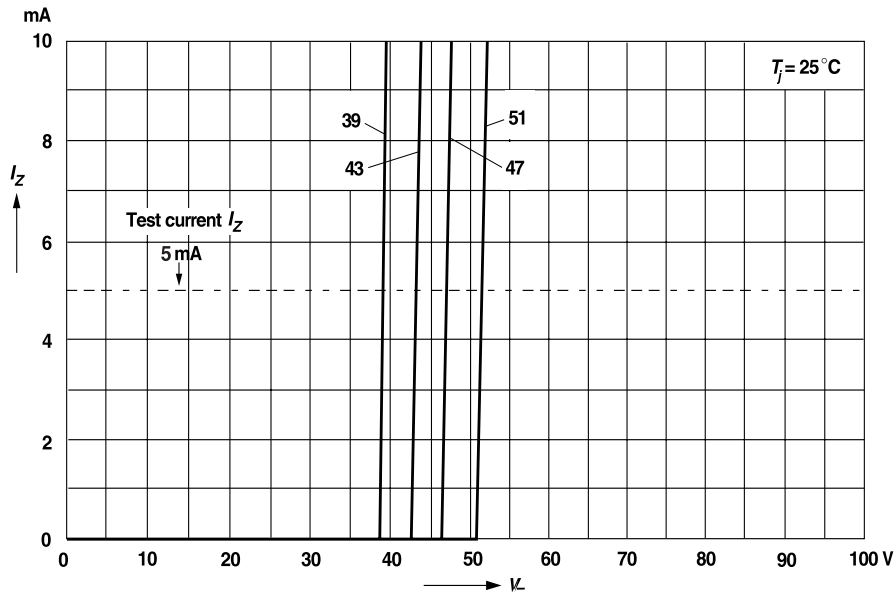

Fig. 17 Breakdown Characteristics



18113

Fig. 18 Breakdown Characteristics

Layout for $R_{\theta JA}$ test

Thickness: Fiberglass 0.059 in. (1.5 mm)

Copper leads 0.012 in. (0.3 mm)

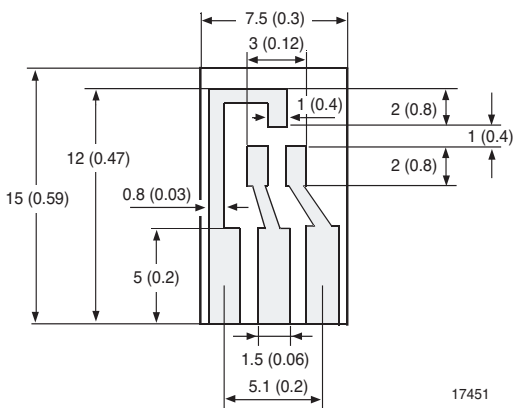

17451

Package Dimensions in mm (Inches)

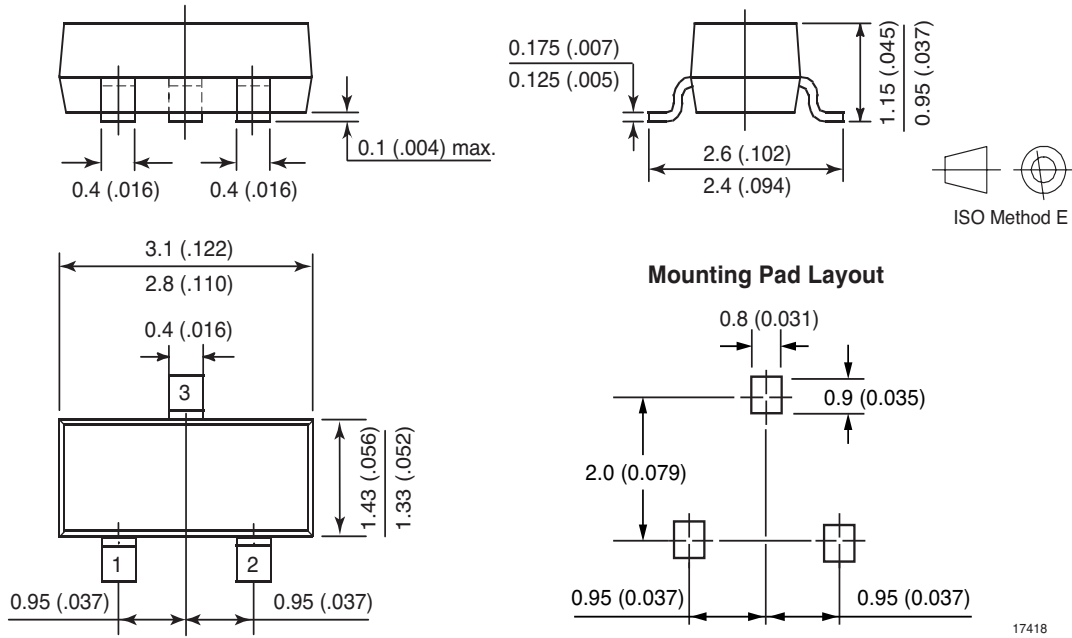

17418

Ozone Depleting Substances Policy Statement

It is the policy of **Vishay Semiconductor GmbH** to

1. Meet all present and future national and international statutory requirements.
2. Regularly and continuously improve the performance of our products, processes, distribution and operating systems with respect to their impact on the health and safety of our employees and the public, as well as their impact on the environment.

It is particular concern to control or eliminate releases of those substances into the atmosphere which are known as ozone depleting substances (ODSs).

The Montreal Protocol (1987) and its London Amendments (1990) intend to severely restrict the use of ODSs and forbid their use within the next ten years. Various national and international initiatives are pressing for an earlier ban on these substances.

Vishay Semiconductor GmbH has been able to use its policy of continuous improvements to eliminate the use of ODSs listed in the following documents.

1. Annex A, B and list of transitional substances of the Montreal Protocol and the London Amendments respectively
2. Class I and II ozone depleting substances in the Clean Air Act Amendments of 1990 by the Environmental Protection Agency (EPA) in the USA
3. Council Decision 88/540/EEC and 91/690/EEC Annex A, B and C (transitional substances) respectively.

Vishay Semiconductor GmbH can certify that our semiconductors are not manufactured with ozone depleting substances and do not contain such substances.

**We reserve the right to make changes to improve technical design
and may do so without further notice.**

Parameters can vary in different applications. All operating parameters must be validated for each customer application by the customer. Should the buyer use Vishay Semiconductors products for any unintended or unauthorized application, the buyer shall indemnify Vishay Semiconductors against all claims, costs, damages, and expenses, arising out of, directly or indirectly, any claim of personal damage, injury or death associated with such unintended or unauthorized use.

Vishay Semiconductor GmbH, P.O.B. 3535, D-74025 Heilbronn, Germany
Telephone: 49 (0)7131 67 2831, Fax number: 49 (0)7131 67 2423